



**VIDEO**

**CASSETTE RECORDER**

**SV-6333X**

**SV-6332X**

**SV-2333X**

**SV-2303X**

## **Instruction Manual**

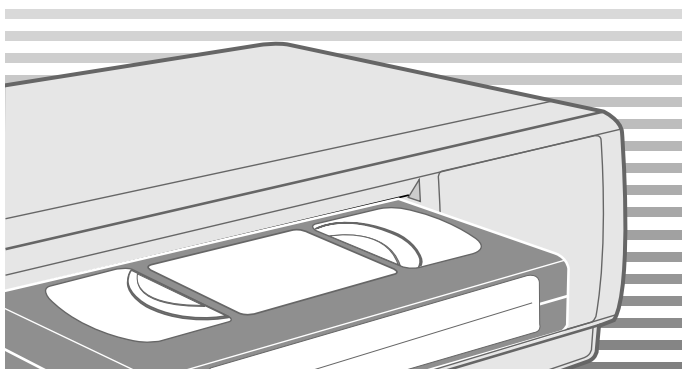

[www.samsungvcr.com](http://www.samsungvcr.com)



## About this manual

Thank you for purchasing a Samsung Video Cassette Recorder (VCR). Your Owner's Instructions contain much valuable information on setting up and using your VCR. Please take the time to read them as they will help you take full advantage of your VCR's features.

The instructions in this manual are for models, SV-6333X, SV-6332X, SV-2333X and SV-2303X. Before you start reading this manual please check your model number. It is displayed on the rear of the VCR.

- ★(SV-6333X): Exceptions only for a certain model, for example SV-6333X.
- Gray shaded areas marked with a star indicate instructions that are only relevant to one model.

## Features Chart

Feature	SV-6333X	SV-6332X	SV-2333X	SV-2303X
IPC (Intelligent Picture Control)	●	●	●	●
Format 16:9	●	●		
Changing recording speed (SP/LP)	●	●		
Connecting a Decoder for scrambled PAY TV broadcasts	●		●	
Automatic Clock setting	●	●	●	●
SHOWVIEW recording	●	●	●	
Hi-Fi and A2	●	●		
VPS (Video Programme System) / PDC (Programme Delivery Control)	●	●	●	●

## Contents

◆ FOREWORD	
■ Safety Instructions .....	5
◆ VCR OVERVIEWS	
■ Front View of the VCR .....	6
■ Rear View of the VCR .....	6
■ Infrared Remote Control .....	7
■ Display Indicator .....	8
■ Accessories .....	8
◆ CONNECTING YOUR VIDEO CASSETTE RECORDER	
■ Deciding How to Connect Your VCR .....	9
■ Connecting Your VCR to the TV using the Coaxial Cable .....	10
■ Connecting Your VCR to the TV using the SCART Cable .....	10
■ Connecting a Decoder for scrambled PAY TV broadcasts (SV-6333X/SV-2333X) ..	11
■ Connecting Your VCR to the Satellite receiver or Other Equipment .....	12
■ Plug & Auto Set Up .....	13
■ Tuning your Television for the VCR .....	14
◆ SETTING UP YOUR VIDEO CASSETTE RECORDER	
■ Inserting Batteries in the Remote Control .....	15
■ Setting the Date and Time .....	15
■ Displaying/Hiding On-Screen Information .....	16
■ Choosing Your Language .....	16
■ Setting the VCR Output Channel .....	17
■ Selecting the RF OUT Sound Mode (B/G-D/K) (SV-6333X/SV-6332X) .....	17
■ Presetting the Stations Automatically .....	18
■ Presetting the Stations Manually .....	19
■ Clearing a Preset Station .....	20
■ Changing the Preset Station Table .....	21
■ Setting the AV2 Connection (SV-6333X/SV-2333X) .....	22
■ Switching between the TV and VCR Modes (SV-6333X/SV-2333X) .....	22
◆ RECORDING TELEVISION BROADCASTS	
■ Selecting the Cassette Type .....	23
■ Selecting the Recording Speed (SV-6333X/SV-6332X) .....	23
■ Protecting a Recorded Cassette .....	24
■ Recording a Programme Immediately .....	24
■ Recording a Programme with Automatic Stop .....	25
■ Using the ShowView Feature (SV-6333X/SV-6332X/SV-2333X) .....	26
■ Modifying ShowView Programming (SV-6333X/SV-6332X/SV-2333X) .....	27
■ Using the Quick Programming Feature .....	28
■ Checking a Preset Recording .....	29
■ Cancelling a Preset Recording .....	29

- ◆ **PLAYING BACK**
  - Playing a Cassette..... 30
  - Adjusting Picture Alignment Manually ..... 30
  - Intelligent Picture Control ..... 31
  - FORMAT 16:9 (WIDE SCREEN) (SV-6333X/SV-2333X) ..... 32
  - Selecting the Colour Mode ..... 32
  - Selecting the Audio Output Mode (SV-6333X/SV-6332X)..... 33
  - Selecting the Audio Mute Mode (SV-2333X/SV-2303X) ..... 33
- ◆ **SEARCHING FOR A SEQUENCE**
  - Playing a Cassette in Slow Motion ..... 34
  - Playing a Sequence Frame by Frame ..... 34
  - Playing a Sequence at Variable Speeds ..... 35
  - Searching for a Specific Sequence ..... 35
  - Auto Repeat Play ..... 36
  - Interval Repeat Play ..... 36
  - Using the Tape Counter ..... 37
- ◆ **ADVANCED RECORDING FEATURES**
  - Using the Assemble Edit Function..... 38
  - Recording from Another VCR or Camcorder..... 38
- ◆ **OTHER FUNCTIONS AND USEFUL RECOMMENDATIONS**
  - Auto Power Off ..... 39
  - Technical Specifications ..... 40
- ◆ **SOLVING PROBLEMS**
  - Problems and Solutions..... 41
  - TV Frequency Table (System-B/G) ..... 42

**Symbols**



① = Step number

The following illustrations represent precautions.



The lightning bolt is a warning sign alerting you to dangerous voltage inside the product.  
DO NOT OPEN THE VCR. Refer to service personnel.

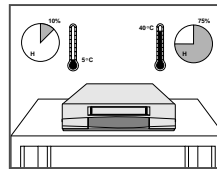

Do NOT expose the VCR to extreme temperature conditions (below 5°C and above 40°C) or to extreme humidity conditions (less than 10% and more than 75%).

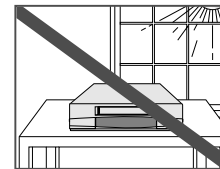

Do NOT expose the VCR to direct sunlight.

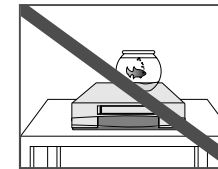

Do NOT expose the VCR to any liquids.

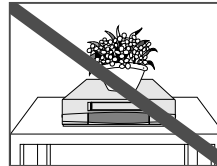

Do NOT place any objects on the VCR or remote control.

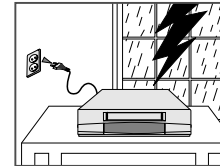

During a storm and/or lightning, unplug the VCR from the mains socket and aerial.

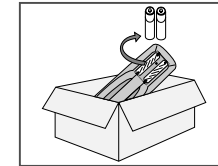

If the remote control is not used for a long period of time, remove the batteries and store it in a cool, dry place.

THIS DEVICE IS NOT FOR USE IN INDUSTRIAL ENVIRONMENTS

## Front View of the VCR

(SV-6333X/SV-6332X/SV-2303X)

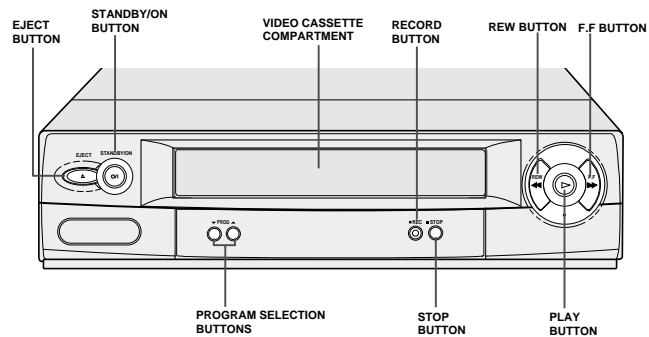

(SV-2333X)

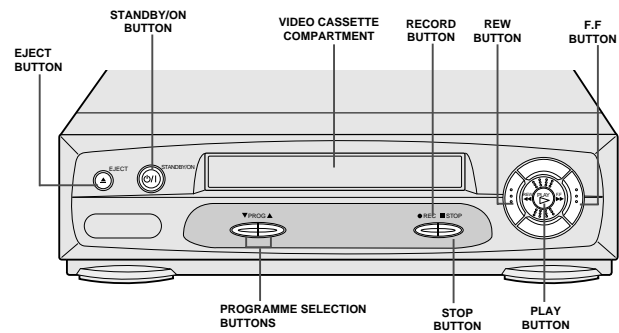

## Rear View of the VCR

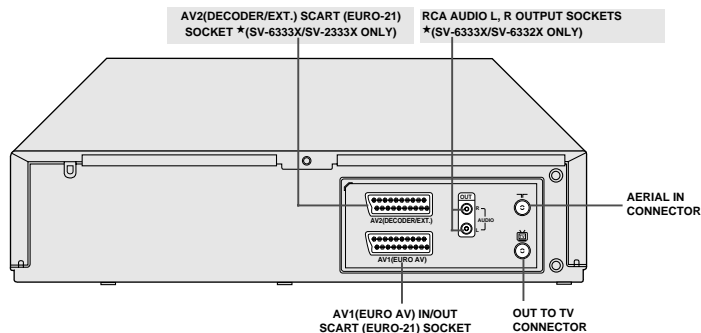

6

## Infrared Remote Control

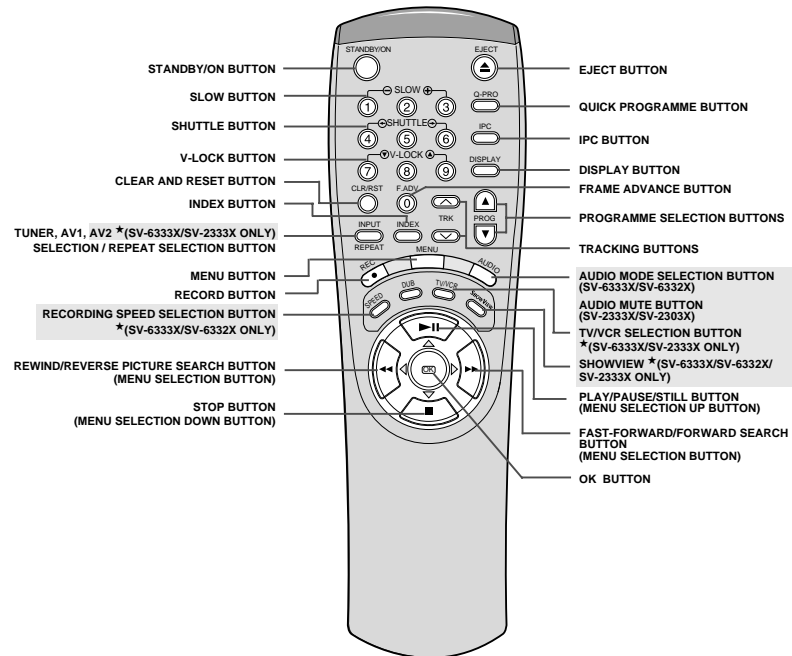

7

## Display Indicator

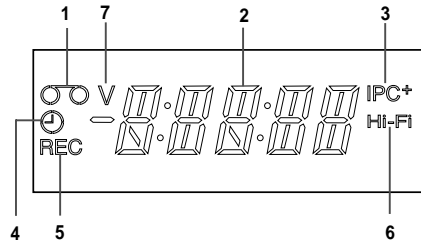

- |   |   |
|---|---|
| 1 Cassette loaded indicator                   | 5 Record indicator                          |
| 2 Multi-function display                      | 6 Hi-Fi indicator *(SV-6333X/SV-6332X ONLY) |
| 3 IPC (Intelligent Picture Control) indicator | 7 VCR indicator *(SV-6333X/SV-2333X ONLY)   |
| 4 Timer indicator                             |   |

## Accessories

You have just purchased a **SAMSUNG Video Cassette Recorder (VCR)**.  
Together with your VCR, you will find the following accessories in the box.

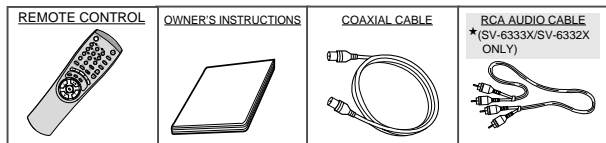

8

## Deciding How to Connect Your VCR

GB

You must take into account various factors when connecting audio or video systems:

- ◆ Types of connectors available on your systems
- ◆ Systems connected permanently to the VCR (satellite receiver for example) or temporarily (camcorder for example)

Your VCR is equipped with the following connectors.

Connector	Location	Type	Direction	Recommended Use
AV1	Rear 	SCART	In/Out ⇄	◆ Television ◆ Satellite receiver ◆ Other VCR
OUT TO TV	Rear 	75 Ω coaxial	Out →	◆ Television
IN FROM ANT.	Rear 	75 Ω coaxial	In ←	◆ Aerial ◆ Cable television network ◆ Satellite receiver
AV2	Rear 	SCART	In/Out ⇄	◆ Decoder for scrambled Pay TV broadcasts Example: CANAL+. ◆ Satellite receiver ◆ Other VCR
*(SV-6333X/SV-2333X only)				
Audio output	Rear 	Audio RCA	Out →	◆ Audio Hi-Fi system
*(SV-6333X/SV-6332X only)				



Whenever you connect an audio or video system to your VCR, ensure that all elements are switched off.

Refer to the documentation supplied with your equipment for detailed connection instructions and associated safety precautions.

9

## Connecting Your VCR to the TV using the Coaxial Cable

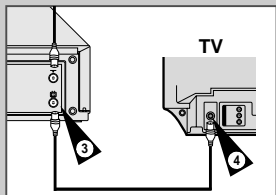
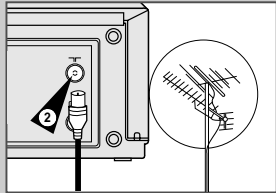

To receive television programmes a signal must be received from one of the following sources:

- ◆ An outdoor aerial
- ◆ An indoor aerial
- ◆ A cable television network
- ◆ A satellite receiver

Make sure that both the television and the VCR are switched off before connecting the cables.

- 1 Remove the aerial or network input cable from the television.
- 2 Connect this cable to the 75Ω coaxial socket marked  $\Gamma$  on the rear of your VCR.
- 3 Plug the coaxial cable supplied into the  socket on your VCR.
- 4 Plug the other end of the coaxial cable into the connector previously used for the aerial on the television.
- 5 To obtain better quality pictures and sound on your television, you can also connect your VCR to the television via the SCART cable (see section below) if your television is equipped with this type of connection.

## Connecting Your VCR to the TV using the SCART Cable

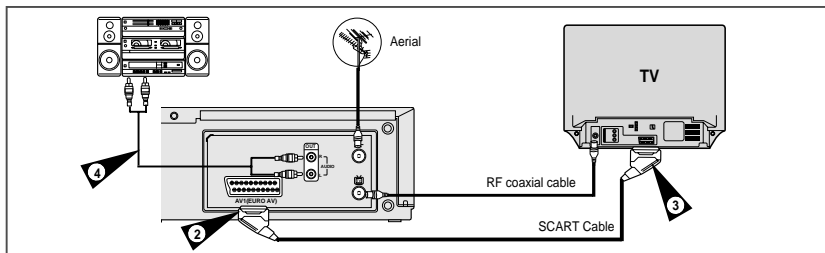

You can connect your VCR to the television using the SCART cable if the appropriate input is available on the television. You thus:

- ◆ Obtain better quality sound and pictures
- ◆ Simplify the setting up procedure of your VCR

Regardless of the type of connection chosen, you must always connect the coaxial cable supplied. Otherwise, no picture will be visible on the screen when the VCR is switched off. Make sure that both the television and the VCR are switched off before connecting the cables.

You can connect your VCR to a Hi-Fi system.

**Example:** You wish to take advantage of the quality of your Hi-Fi stereo system when watching a programme or recording via your VCR. \*(SV-6333X/SV-6332X only)

- 1 Connect the coaxial cable as indicated in the above section.
- 2 Connect one end of the SCART cable to the AV1(EURO AV) socket on the rear of the VCR.
- 3 Plug the other end into the appropriate connector on the television.
- 4 Plug the RCA Audio cable with stereo system into the Audio out socket on the rear of the VCR. \*(SV-6333X/SV-6332X only)

## Connecting a Decoder for scrambled PAY TV broadcasts ★(SV-6333X/SV-2333X Only)

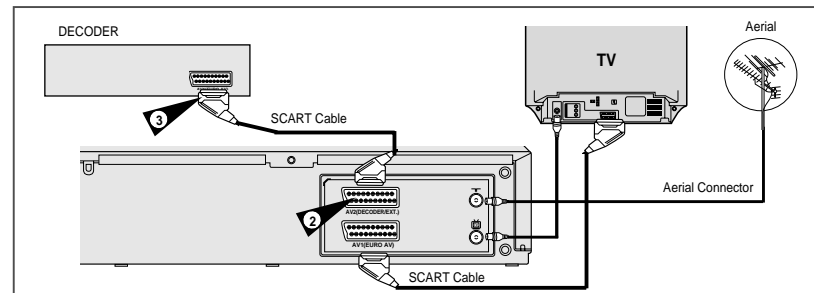

This VCR is fully equipped to receive scrambled Pay TV broadcasts.

**Example:** CANAL+ or Premiere broadcasts.

You can:

- ◆ Record a scrambled programme while watching another channel
- ◆ Record another channel while watching a scrambled programme

When the DECODER is connected to the AV2 socket, AV2 SET must be set to DEC (see page 22)

- 1 Connect the VCR to the television as indicated on page 10.
- 2 Plug the SCART cable with the decoder into the AV2(DECODER/EXT.) socket on the rear of the VCR.
- 3 Plug the other end into the decoder.

## Connecting Your VCR to the Satellite receiver or Other Equipment

You can connect your VCR to the Satellite receiver or other VCR using the SCART cable if the appropriate outputs are available on the equipment chosen. The following illustrations give a few examples of the connection possibilities.

### 1. AV1(EURO AV): By means of 21-pin Scart Cable

Plug the SCART Cable with satellite receiver or other equipment into the AV1(EURO AV) socket on the rear of the VCR.

After making this connection, select the source by pressing the INPUT button for the AV1 input sources.

### 2. By means of RF Coaxial Cable

After making this connection, you must preset the station received through the satellite tuner.

RF output channel of the satellite receiver should be adjusted away from channel 36, which is used by the VCR, e.g. re-adjust to channel 33.

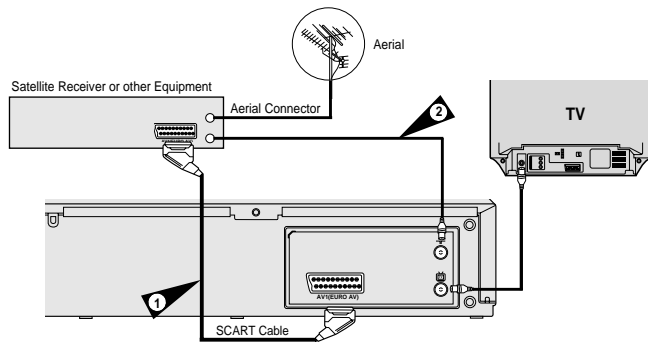

### 1. AV2 IN: By means of 21-pin Scart Cable ★(SV-6333X/SV-2333X only)

When the satellite receiver or other equipment is connected to the AV2 socket, **AV2 SET** must first be set to **EING.** (see page 22)

Plug the SCART Cable with satellite receiver or other equipment into the AV2(DECODER/EXT.) socket on the rear of the VCR.

After making this connection, select the source by pressing the INPUT button for the AV2 input sources.

### 2. By means of RF Coaxial Cable

After making this connection, you must preset the station received through the satellite tuner.

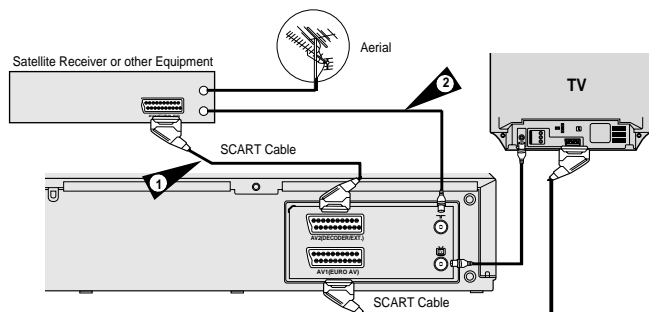

## Plug & Auto Set Up

Your VCR will automatically set itself up when it is plugged into the mains for the first time. TV stations will be stored in memory. The process takes a few minutes. Your VCR will then be ready for use.

- 1 Connect the coaxial cable as indicated on page 10. (Connecting Your VCR to the TV Using the Coaxial Cable)
- 2 Plug the VCR into the mains. It will automatically tune itself in and store TV stations in the memory.
- 3 The process will finish after a few minutes. Then the VCR automatically switches itself off.

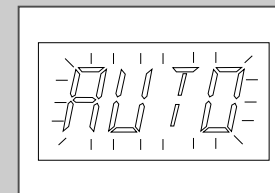
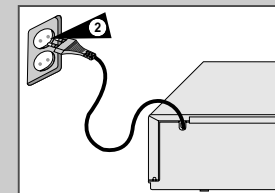
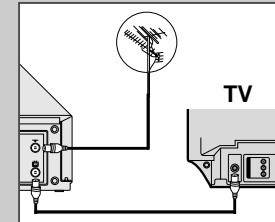

## Tuning Your Television for the VCR

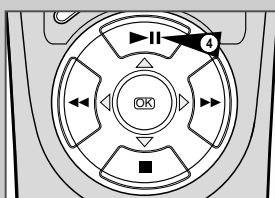
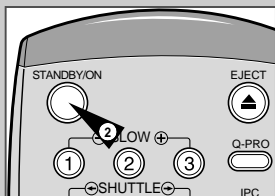

*You must tune your television for the VCR only if you are not using a Scart cable*

➤ To view pictures from your VCR when a Scart cable is used, the television must be set to the audio/video mode (AV).

- 1 Switch on the television.
- 2 Switch on the VCR by pressing STANDBY/ON on the front of the VCR or STANDBY/ON on the remote control.
- 3 Select a programme position on the television to be reserved for use with your VCR.
- 4 Insert the video cassette in the VCR. Check that the VCR starts reading the cassette; if not, press ►|| button.
- 5 Start a scan on your television or set the television to UHF channel 36.
- 6 Fine tune the television until the pictures and sound are obtained clearly.
- 7 If you cannot find the pictures and sound, or there is interference from nearby channels, it may be necessary to change the setting of the VCR output channel (see Solving Problems section of this manual).
- 8 When the picture and sound are perfectly clear, store this channel at the desired programme position on the television.  
Result: That programme is now reserved for use with your VCR.



## Inserting Batteries in the Remote Control

You must insert or replace the batteries in the remote control when you:

- ◆ Purchase the video cassette recorder
- ◆ Find that the remote control is no longer working correctly

- 1 Push the tab in the direction of the arrow to release the battery compartment cover on the rear of the remote control.
- 2 Insert two AA, R6 or equivalent batteries, taking care to respect the polarities:
  - ◆ + on the battery with + on the remote control
  - ◆ - on the battery with - on the remote control
- 3 Replace the cover by aligning it with the base of the remote control and pushing it back into place.

➤ Do not mix different battery types (manganese and alkaline for example).

✋ Entsorgung von Batterien und Akkus

Batterien und Akkus gehören nicht in den Hausmüll. Als Verbraucher sind Sie gesetzlich verpflichtet, alte Batterien und Akkus zur umweltschonenden Entsorgung zurückzugeben. Sie können Ihre alten Batterien und Akkus bei den öffentlichen Sammelstellen in Ihrer Gemeinde oder überall dort abgeben, wo Batterien und Akkus der betreffenden Art verkauft werden.

Bitte achten Sie darauf, Akkus und Lithiumzellen nur im entladenen Zustand in die Sammelbehälter zu werfen.

Sichern Sie nicht vollständig entladene Akkus gegen Kurzschlüsse.

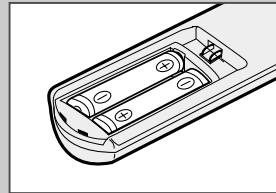
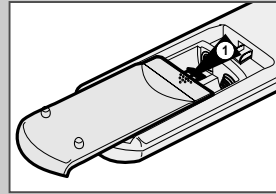

## Setting the Date and Time

Your VCR contains a 24-hour clock and calendar used to:

- ◆ Automatically stop programme recording
- ◆ Preset your VCR to record a programme automatically

You must set the date and time when:

- ◆ You purchase the video cassette recorder
- ◆ The power supply remains off for more than 1 hour

- ✋ The date and time are set automatically from the broadcast signal, but this function will not operate if there is no Teletext signal.
- ◆ Do not forget to reset the time when you change clocks from winter to summer time and vice versa.

- 1 Press MENU on the remote control.  
**Result:** The programming menu is displayed.
- 2 Press the corresponding ▲, ▼ or ◀, ▶ buttons to select the UHR EINSTELLEN option.
- 3 Press the OK button to select this option.  
**Result:** The UHR EINSTELLEN menu is displayed.
- 4 Press ◀ or ▶ to select the hour, minutes, day, month and year.  
**Result:** The option selected flashes.
- 5 Press the ▲ or ▼ buttons to increase or decrease the value.  
**Result:** The day of the week is displayed automatically.
  - You can hold the ▲ or ▼ buttons down to scroll more quickly through the values.
- 6 On completion, press MENU twice to exit the menu.

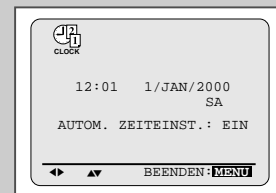

## Displaying/Hiding On-Screen Information

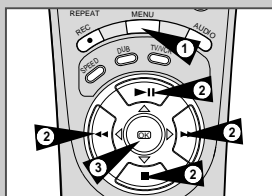

★(SV-6333X/SV-2333X)

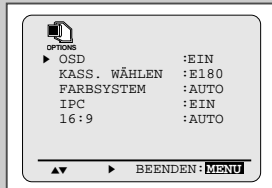

★(SV-6332X/SV-2303X)

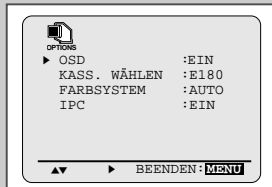

Your VCR displays most information both on the VCR and the television.

You can choose to display or hide this information on the television screen (except for the Index, Programming MENU and Showview function ★(SV-6333X/SV-6332X/SV-2333X only), which cannot be hidden).

- Press MENU on the remote control.  
**Result:** The programming menu is displayed.
- Press the corresponding ▲, ▼ or ◀, ▶ buttons to select the **EINSTELLUNGEN** option.
- Press the OK button to select this option.  
**Result:** The **EINSTELLUNGEN** menu is displayed.
- Press the corresponding ▲ or ▼ buttons, until the cursor is placed in front of the OSD option.
- To... **Press ◀ or ▶, until...**

Display on-screen information	<b>EIN</b> is displayed.
Hide on-screen information	<b>AUS</b> is displayed.
- On completion, press MENU twice to exit the menu.

## Choosing Your Language

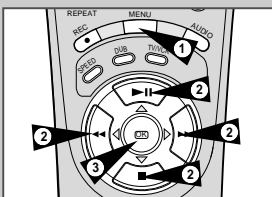

You can change the language in which information is displayed on the screen.

- Press MENU on the remote control.  
**Result:** The programming menu is displayed.
- Press the corresponding ▲, ▼ or ◀, ▶ buttons to select the **SPRACHE WÄHLEN** option.
- Press the OK button to select this option.  
**Result:** The **SPRACHE WÄHLEN** menu is displayed.
- Select the required language by pressing the ▲ or ▼ buttons.
- Press OK to store the language selected.
- Press MENU to exit the menu.  
**Result:** From now on, all the on-screen information will be displayed in the language selected.

## Setting the VCR Output Channel

Your VCR output channel may need to be changed if the pictures suffer from interference or if your TV cannot find the pictures. Also, you can change the VCR output channel to adjust the frequency in which information is displayed on the screen.

- Press MENU on the remote control.  
**Result:** The programming menu is displayed.
- Press the corresponding ▲, ▼ or ◀, ▶ buttons to select the **SETUP** option.
- Press the OK button to select this option.  
**Result:** The **SETUP** menu is displayed.
- Press the ▲ or ▼ buttons, until the cursor is placed in front of the **HF-AUSGANG** option.
- Select the required output channel (CH21-CH69) by pressing the ◀ or ▶ buttons.
- On completion, press MENU twice to exit the menu. Then tune your television again (see page 14).

★(SV-6333X)

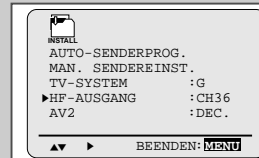

★(SV-6332X)

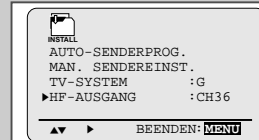

★(SV-2333X)

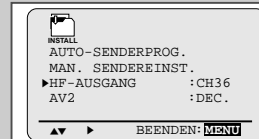

★(SV-2303X)

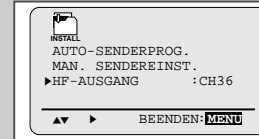

## Selecting the RF OUT Sound Mode (B/G-D/K) ★(SV-6333X/SV-6332X Only)

You can choose the sound mode (B/G or D/K) according to the TV set connected to your VCR.

- Press MENU on the remote control.  
**Result:** The programming menu is displayed.
- Press the corresponding ▲, ▼ or ◀, ▶ buttons to select the **SETUP** option.
- Press the OK button to select this option.  
**Result:** The **SETUP** menu is displayed.
- Press the corresponding ▲ or ▼ buttons, until the cursor is placed in front of the **TV-SYSTEM** option.
- Press the ▶ button to select G or K.
- On completion, press MENU twice to exit the menu.

★(SV-6333X)

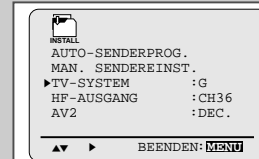

★(SV-6332X)

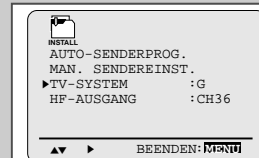

## Presetting the Stations Automatically

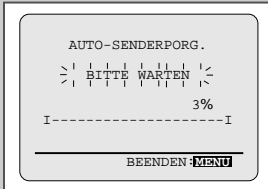
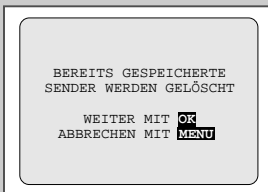
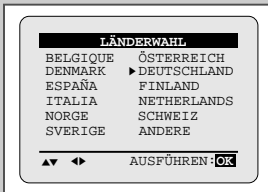

➡ You do not need to preset the stations if you have already set them automatically (see Plug & Auto Set Up on page 13).

**Your VCR contains a built-in tuner used to receive television broadcasts.**  
You must preset the stations received through the tuner. This can be done:

- ◆ Plug & Auto Set up (see page 13)
- ◆ Automatically
- ◆ Manually (see page 19)

You can store up to 99 stations.

➡ To enable the VCR to decode a scrambled TV station, the decoder must be activated after the scan (see pages 19 or 21).  
★(SV-6333X/SV-2333X Only)

- 1 Press the MENU button on the remote control.  
**Result:** The programming menu is displayed.
- 2 Press the corresponding ▲, ▼ or ◀, ▶ buttons to select the **SETUP** option.
- 3 Press the OK button to select this option.  
**Result:** The **SETUP** menu is displayed.
- 4 Press the corresponding ▲ or ▼ buttons, until the cursor is placed in front of the **AUTO-SENDERPROG.** option. And then press the ▶ button to select this option.  
**Result:** The country selection MENU is displayed.
- 5 Press the ▲ or ▼ buttons to select your country.  
➡ The VCR searches for the stations according to a preset preference list corresponding to the country that you have selected.
- 6 Press OK button.  
**Result:** A message appears, indicating that any channels already preset on your VCR will be deleted.
- 7 Press OK to start the auto scanning.  
**Result:**
  - ◆ The **BITTE WARTEN** indication flashes on the television screen.
  - ◆ The first frequency band is scanned and the first station found is displayed and stored.
  - ◆ The VCR then searches for the second station and so on.
  - ◆ When the automatic scanning procedure has finished, the VCR switches automatically to programme 1.
- 8 If you wish to cancel the auto scanning before the end, press the MENU button three times to exit the menu.

➡

- ◆ The time and date are set automatically from the broadcast signal. If the signal is weak or ghosting occurs, the time and date may not be set automatically. In this case, they should be set manually (see page 15).
- ◆ Once the auto scanning procedure has finished, some stations may have been stored more than once; select the stations with the best reception and delete the ones no longer required (see page 20).

## Presetting the Stations Manually

➡ You do not need to preset the stations manually if you have already set them automatically.

➡ To enable the VCR to decode a scrambled TV station, the decoder must be switched on. ★(SV-6333X/SV-2333X Only)

- 1 Press the MENU button on the remote control.  
**Result:** The programming menu is displayed.
- 2 Press the corresponding ▲, ▼ or ◀, ▶ buttons to select the **SETUP** option.
- 3 Press the OK button to select this option.  
**Result:** The **SETUP** menu is displayed.
- 4 Press the corresponding ▲ or ▼ buttons, until the cursor is placed in front of the **MAN. SENDEREINST.** option.
- 5 Press the ▶ button to select **MAN. SENDEREINST.** option.  
**Result:** The **SENDER-TABELLE** menu is displayed.
- 6 Press the ▲ or ▼ buttons to select a programme number as required.
- 7 Press the ▶ button to preset the station.  
**Result:** The **MAN. SENDEREINST.** menu is displayed.
- 8 Press the ◀ or ▶ buttons to start scanning.  
**Result:** The frequency band is scanned and the first station found is displayed.  
If you know the number of the channel you want, press the numeric buttons on the remote control for example, for channel E21, first press "0" and then press "2", "1" (see page 42).
- ★ With SV-6333X/SV-2333X, you can select **DECODER**.
  - a. Press the ▼ button to place the cursor in front of the **DECODER**.
  - b. Press the ▶ button to activate or deactivate use of the decoder for the TV station, if necessary.
- 9 Press the ▲ or ▼ buttons until the cursor is placed in front of the **NAME**.  
The station name is set automatically from the broadcast signal.
- 10 To change the programme's name, press the ▶ button.  
**Result:** The first letter of the name flashes.
- 11 **To...** **Then...**  
Select a character in the name Press the ▲ or ▼ button until the required character is displayed (letters, numbers or "-" character).  
Move to the next or previous character Press the ▶ or ◀ buttons respectively.
- 12 **If you...** **Then...**  
Wish to store the station displayed ◆ Press the corresponding ▲ or ▼ buttons to place the cursor in front of the **FEIN**.  
◆ Press the ◀ or ▶ buttons to adjust the picture, if necessary.  
◆ Press OK to store the station .  
  
Do not wish to store the station displayed ◆ Press the corresponding ▲ or ▼ buttons to place the cursor in front of the **CH**.  
◆ Press the ◀ or ▶ buttons to go on scanning the frequency band and display the next station  
◆ Go back to the beginning of Step 12
- 13 Repeat this procedure from Step 6 onwards, until all the required stations have been stored.
- 14 On completion, press the MENU button three times to exit the menu.

GB



★(SV-6333X/SV-2333X)

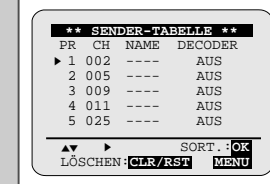

★(SV-6332X/SV-2303X)

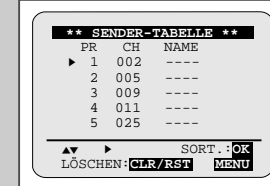

★(SV-6333X/SV-2333X)

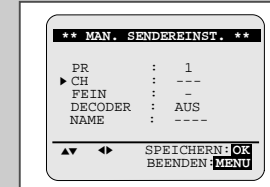

★(SV-6332X/SV-2303X)

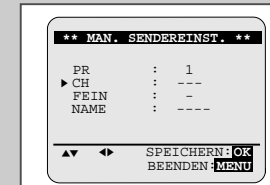

## Clearing a Preset Station



★(SV-6333X/SV-2333X)

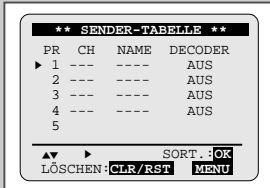

★(SV-6332X/SV-2303X)

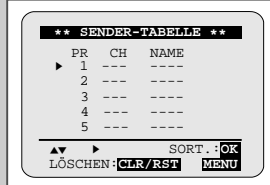

If you have stored a TV station:

- ◆ That you do not require
- ◆ At the wrong programme position

you can cancel it.

- 1 Press the MENU button on the remote control.  
**Result:** The programming menu is displayed.
- 2 Press the corresponding ▲, ▼ or ◀, ▶ buttons to select the **SETUP** option.
- 3 Press the OK button to select this option.  
**Result:** The **SETUP** menu is displayed.
- 4 Press the corresponding ▲ or ▼ buttons, until the cursor is placed in front of the **MAN. SENDEREINST.** option.
- 5 Press the ▶ button to select this option.  
**Result:** The **SENDER-TABELLE** menu is displayed.
- 6 Press the corresponding ▲ or ▼ buttons, until the cursor is placed in front of the required preset TV station. (PR)
- 7 Press the CLR/RST button.
- 8 Repeat the same procedure from Step 6 onwards until all the required stations have been cleared.
- 9 On completion, press the MENU button three times to exit the menu.

## Changing the Preset Station Table

You can rearrange the preset TV stations according to your own preferences programme number assigned to the station.

- 1 Press the MENU button on the remote control.  
**Result:** The programming menu is displayed.
- 2 Press the corresponding ▲, ▼ or ◀, ▶ buttons to select the **SETUP** option.
- 3 Press the OK button to select this option.  
**Result:** The **SETUP** menu is displayed.
- 4 Press the corresponding ▲ or ▼ buttons, until the cursor is placed in front of the **MAN. SENDEREINST.** option.
- 5 Press the ▶ button to select this option.  
**Result:** The **SENDER-TABELLE** menu is displayed.
- 6 Press the corresponding ▲ or ▼ buttons, until the cursor is placed in front of the required preset TV programme.  
**Result:** The selected station is displayed at the same time on the television screen.
- 7 To change the programme number assigned to a station (PR5 instead of PR1 for example):
  - ◆ Press OK
  - ◆ Press the ▲ or ▼ buttons until the cursor is placed in front of the programme to which the station is to be moved
  - ◆ Press OK again
- 8 Repeat this procedure from Step 6 onwards, until all the required stations have been stored.
- 9 On completion, press the MENU button three times to exit the menu.

GB

★(SV-6333X/SV-2333X)

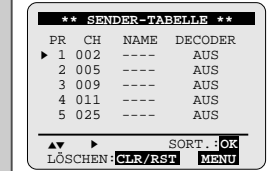

★(SV-6333X/SV-2333X)

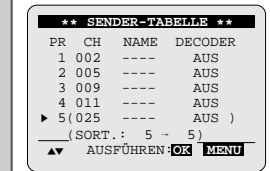

★(SV-6333X/SV-2333X)

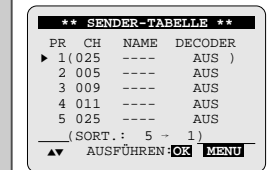

★(SV-6333X/SV-2333X)

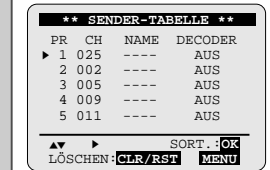

★(SV-6332X/SV-2303X)

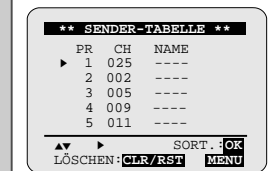

## Setting the AV2 Connection ★(SV-6333X/SV-2333X Only)



★(SV-6333X)

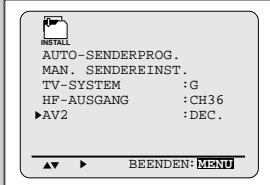

★(SV-2333X)

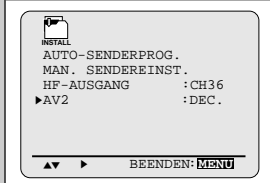

If you wish to use the AV2 socket for a PAY TV DECODER, you must change AV2 to the required position.

- Press MENU on the remote control.  
**Result:** The programming menu is displayed.
- Press the corresponding ▲, ▼ or ◀, ▶ buttons to select the **SETUP** option.
- Press the OK button to select this option.  
**Result:** The **SETUP** menu is displayed.
- Press the corresponding ▲ or ▼ buttons, until the cursor is placed in front of the **AV2** option.
- When...** **Press ◀ or ▶, until...**
  - Another VCR or satellite receiver is connected to the AV2(DECODER/EXT.) socket  
**EING.** is displayed.
  - The decoder is connected to the AV2(DECODER/EXT.) socket  
**DEC.** is displayed.
- On completion, press MENU twice to exit the menu.

## Switching between the TV and VCR Modes ★(SV-6333X/SV-2333X Only)

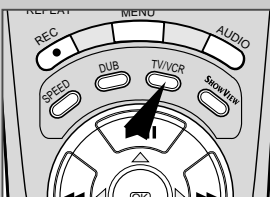

The TV/VCR button allows you to record one channel with the VCR while you watch another channel on the TV.

- | When the VCR indicator is...   | Your television...   |
|--------------------------------|--|
| On                             | The television receives the picture from the VCR and you can select channels with the PROG (▲ or ▼) buttons on the VCR or the remote control.  |
| Off (or the VCR is turned off) | The television receives the picture from your home aerial or cable television system as it did before you connected the VCR.<br>You can then use the programme (▲ or ▼) buttons on your television to select the channels. |

To switch the VCR indicator on and off, simply press the TV/VCR button.

## Selecting the Cassette Type

If you wish to use the tape counter to display the time remaining on a cassette, you must indicate the type of cassette inserted.

- Press MENU on the remote control.  
**Result:** The programming menu is displayed.
- Press the corresponding ▲, ▼ or ◀, ▶ buttons to select the **EINSTELLUNGEN** option.
- Press the OK button to select this option.
- Press the corresponding ▲ or ▼ buttons, until the cursor is placed in front of the **KASS. WÄHLEN** option.
- Press the ◀ or ▶ buttons as many times as required, until the correct cassette length is displayed.
- Press MENU twice to exit the menu.

## Selecting the Recording Speed ★(SV-6333X/SV-6332X Only)

You can record a cassette at two different speeds:

- ◆ **SP (Standard Play)**
- ◆ **LP (Long Play)**

In Long Play modes:

- ◆ Each cassette lasts twice as long
- ◆ The recording is of a slightly lower quality

To record a cassette... Press the **SPEED** button on the remote control, until...

- |                       |                         |
|-----------------------|-------------------------|
| In standard play mode | <b>SP</b> is displayed. |
| In long play mode     | <b>LP</b> is displayed. |

★(SV-6333X/SV-2333X)

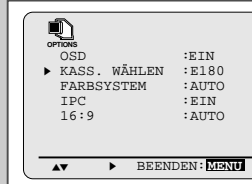

★(SV-6332X/SV-2303X)

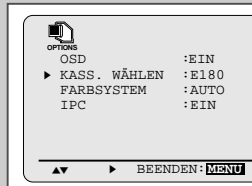

Type	Recording Time (in SP)
E-180	180 mins. or 3 hours
E-240	240 mins. or 4 hours
E-260	260 mins. or 4 hours and 20 mins.
E-300	300 mins. or 5 hours

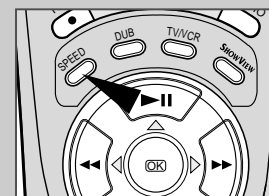

## Protecting a Recorded Cassette

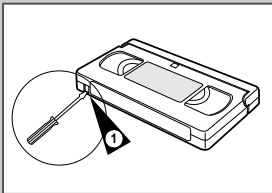

Video cassettes have a safety tab to prevent accidental erasure. When this tab has been removed, you cannot record on the tape.

- 1 If you wish to protect a cassette, break off the tab using a small screwdriver.
- 2 To re-record over a protected cassette (safety tab broken), cover the hole with adhesive tape.

## Recording a Programme Immediately

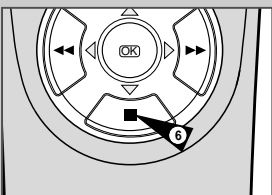
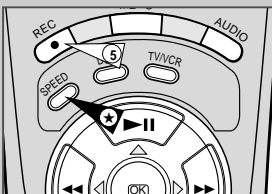
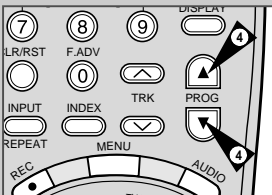

Before recording a programme, you must have preset the corresponding station (unless you are recording via an external video source). If you have not done so, refer to pages 18 and 19.

- 1 Switch on the television.
  - 2 To monitor the programme being recorded, select the television channel reserved for use with your VCR (or the AV input if used).
  - 3 Insert the cassette on which the programme is to be recorded, with the window visible and the safety tab intact or the opening covered with adhesive tape.  
**Result:** The VCR is switched on automatically.
  - 4 Select:
    - ◆ The station to be recorded using the PROG (▲ or ▼) buttons or
    - ◆ The AV1 or AV2 ★(SV-6333X/SV-2333X only) source using the INPUT button for a satellite tuner or external video source**Result:** The station number is displayed and the programme can be seen on the television.
- ★ With SV-6333X/SV-6332X, you can select the recording speed (SP/LP). Press the SPEED button.
- 5 Hold REC (●) down for a while to start recording.  
**Result:** The record indicator appears on the television and VCR display. An index is recorded on the tape (see page 35).
  - 6 To stop recording, press ■ once.

- 
- ◆ If the cassette is ejected when you start recording, check that the safety tab is intact or the opening is covered with adhesive tape.
  - ◆ If you reach the end of the tape while recording, the cassette rewinds automatically.

## Recording a Programme with Automatic Stop

This function enables you to record up to nine hours of programmes. (LP)

Your VCR stops automatically after the requested length of time.

- 1 Switch on the television.
  - 2 To monitor the programme being recorded, select the television channel reserved for use with your VCR (or the AV input if used)
  - 3 Insert the cassette on which the programme is to be recorded, with the window visible and the safety tab intact or the opening covered with adhesive tape.  
**Result:** The VCR is switched on automatically.
  - 4 Select:
    - ◆ The station to be recorded using the PROG (▲ or ▼) buttons or
    - ◆ The AV1 or AV2 ★(SV-6333X/SV-2333X only) source using the INPUT button for a satellite tuner or external video source**Result:** The channel number is displayed and the programme can be seen on the television.
- ★ With SV-6333X/SV-6332X, you can select the recording speed (SP/LP). Press the SPEED button.
- 5 Hold the REC button (●) down for a while to start recording.  
**Result:** The record indicator appears on the television screen and VCR display. An index is recorded on the tape (see page 35).
  - 6 Press the REC button (●) several times to increase the recording time in:
    - ◆ 30-minute intervals up to four hours
    - ◆ 1-hour intervals up to nine hours (LP)**Result:** The length is displayed on the television displays. The selected programme is recorded for the length of time requested. At the end of that time, the VCR stops recording automatically.
  - 7 If you wish to cancel the recording before the end, press STANDBY/ON.

- ☞ If the end of the tape is reached while recording:
- ◆ The recording stops
  - ◆ The VCR automatically turns off

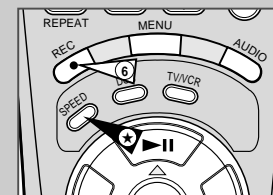
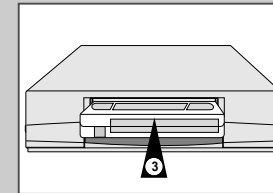

## Using the ShowView Feature <sup>★</sup>(SV-6333X/SV-6332X/SV-2333X Only)

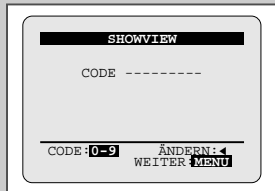
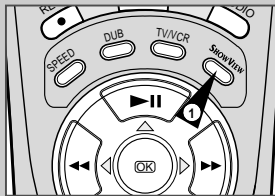

★(SV-6333X/SV-6332X)

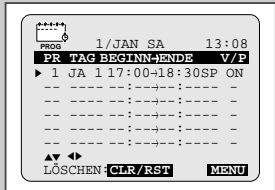

★(SV-2333X)

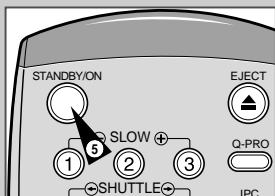
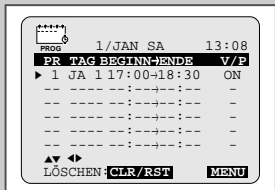

### Before presetting your VCR:

- ◆ Switch on both the television and your VCR
- ◆ Check that the date and time are correct
- ◆ Insert the cassette on which the programme is to be recorded (safety tab intact)

### Up to six programmes can be preset.

- 1 Press the SHOWVIEW button.  
**Result:** A message is displayed to allow you to enter the ShowView code.

☞ If all six programmes have been set, the message **ALLE SPEICHERPLÄTZE SIND BELEGT** is displayed. Refer to page 29 if you wish to cancel a preset recording.

- 2 Press the numeric buttons to enter the code opposite the programme that you wish to record in your television magazine.
  - If you wish to correct the ShowView code that you are entering:
    - ◆ Press the ◀ button until the digit to be corrected is cleared
    - ◆ Enter the correct digit

- 3 Press the MENU or Showview button.  
**Result:** The information concerning the programme is displayed.
  - ☞ When using the ShowView function for the first time with stored stations, the programme number flashes. This one time, you must enter the station number manually by pressing the ▲ or ▼ buttons. Refer to the following page if:
    - ◆ The programme number or times flash
    - ◆ You wish to modify the programme

- 4 If the programme and times are correct, press the MENU button.

- 5 Press the STANDBY/ON button to activate the timer.  
**Result:** The Record indicator (Ⓜ) is displayed.
  - ☞ If no cassette has been inserted when you press STANDBY/ON the Record indicator (Ⓜ) flashes. If the safety tab on the cassette has been broken, the cassette is ejected. Insert the appropriate cassette.

- 6 Refer to page 29 if you wish to:
  - ◆ Check that your VCR has been programmed correctly
  - ◆ Cancel a preset recording

☞ The numbers next to each TV programme listing are ShowView code numbers, which allow you to programme your videorecorder instantly with the remote control. Tap in the ShowView code for the programme you wish to record.

<sup>TM</sup> ShowView is a trademark of Gemstar Development Corporation. The ShowView system is manufactured under licence from Gemstar Development Corporation.

## Modifying ShowView Programming <sup>★</sup>(SV-6333X/SV-6332X/SV-2333X Only)

If you wish to correct the programme displayed or modify certain elements, such as the recording speed, you can do so before you press MENU a second time to confirm.

If you wish to...	Then...
Select an input source other than the tuner AV1 or AV2	<ul style="list-style-type: none"> <li>◆ Press the ◀ or ▶ buttons, until the <b>PR</b> selection flashes.</li> <li>◆ Press the INPUT button one or more times to change the input source selection. <b>Result:</b> The programme number is replaced by:                             <ul style="list-style-type: none"> <li>• A1 or A2 for a satellite tuner or external video input (used by another VCR for example)</li> </ul> </li> <li>➤ The input source must be selected before changing any other value.</li> </ul>
Record a programme every day (Monday to Sunday) at the same time	<ul style="list-style-type: none"> <li>◆ Press the ◀ or ▶ buttons, until the <b>DAY</b> selection flashes.</li> <li>◆ Press the ▲ or ▼ buttons, until the <b>DLY</b> (Daily) value is displayed.</li> </ul>
Record a programme every week on the same day and at the same time	<ul style="list-style-type: none"> <li>◆ Press the ◀ or ▶ buttons, until the <b>DAY</b> selection flashes.</li> <li>◆ Press the ▲ or ▼ buttons, until the <b>W-</b> (Week) value is displayed, followed by the required day. <b>Example:</b> <b>W-SA</b> (Weekly Saturday)</li> </ul>
Extend the recording time	<ul style="list-style-type: none"> <li>◆ Press the ◀ or ▶ buttons, until the <b>STOP</b> selection flashes.</li> <li>◆ Press the ▲ or ▼ buttons to increase or decrease the stop time.</li> </ul>
Select VPS recording	<ul style="list-style-type: none"> <li>◆ Press the ◀ or ▶ buttons, until the <b>V/P</b> selection flashes.</li> <li>◆ Press the ▲ or ▼ buttons until the <b>ON</b> or " " indication is displayed.                             <ul style="list-style-type: none"> <li>☞ Do not select VPS unless you are sure the programme you wish to record is broadcast with VPS. If you do set VPS ON (by selecting "ON" in the right - hand column on the screen), then you must set up the start-time EXACTLY according to the published TV schedule. Otherwise the timer recording won't take place.</li> </ul> </li> </ul>
Select the recording speed <sup>★</sup> (SV-6333X/SV-6332X only)	<ul style="list-style-type: none"> <li>◆ Press the ◀ or ▶ buttons, until the recording speed selection flashes.</li> <li>◆ Press the ▲ or ▼ buttons until the correct indication is displayed:                             <ul style="list-style-type: none"> <li>• <b>AUTO</b> (Auto Tape Speed Select) : see page 28</li> <li>• <b>SP</b> (Standard Play)</li> <li>• <b>LP</b> (Long Play)</li> </ul> </li> </ul>

## Using the Quick Programming Feature

The Quick Programming feature allows you to preset the VCR to record a programme up to one month before that programme is to be broadcast. Up to six programmes can be preset.

Before presetting a recording, check that the date and time are correct.

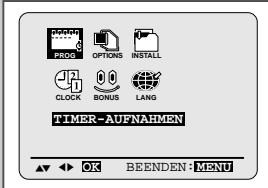

★(SV-6333X/SV-6332X)

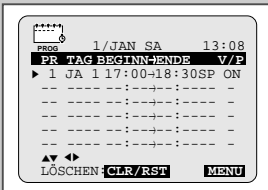

★(SV-2333X/SV-2303X)

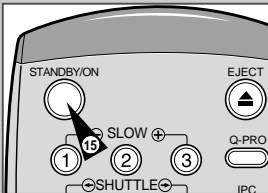
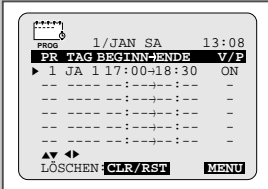

- 1 - Insert the cassette and press the Q-PRO button or
    - ◆ Press MENU on the remote control.  
Result: The programming menu is displayed.
    - ◆ Press the OK button to select this option.  
Result: The **TIMER-AUFNAHMEN** menu is displayed.
  - 2 Press ► to select the input source.
  - 3 Select the required station by pressing the ▲, ▼ buttons or INPUT to select the AV1 or AV2 ★(SV-6333X/SV-2333X only) input sources.
  - 4 Press ► to select the recording day.
  - 5 Select the required day by pressing the ▲ or ▼ buttons.
  - 6 Press ► to select the recording start time.
  - 7 Select the required hour value by pressing the ▲ or ▼ buttons.
  - 8 Press ► to select the minutes.
  - 9 Select the required minute value by pressing the ▲ or ▼ buttons.
  - 10 Press ► to select the recording end time.
  - 11 Select the required recording end time by pressing the ▲ or ▼ buttons, following the same procedure as when selecting the recording start time.
- ★ With SV-6333X/SV-6332X, you can select the recording speed (AUTO/SP/LP).
- a. Press ► to select the recording speed.
  - b. Press the ▲ or ▼ buttons to switch between the **AUTO**, **SP** (Standard Play) or **LP** (Long Play) recording speeds.
- 12 Press ► to select the VPS(V/P) recording mode.
  - 13 Press the ▲ or ▼ buttons to toggle between the VPS mode (marked ON) and the non-VPS mode (marked -).
  - 14 When you have finished, press the MENU button.
  - 15 Press the STANDBY/ON button to activate the timer.  
Result: Before starting recording, the VCR compares the timer duration with the remaining time on the cassette.

Auto Tape Speed Select ★(SV-6333X/SV-6332X Only)  
The VCR's "Auto Tape Speed Select" function compares the duration of the timer recording to the actual recording time remaining on the tape loaded. If there is insufficient tape to complete a timer recording in AUTO mode, the VCR automatically switches to LP mode to record the whole programme.  
E.g. If there is a one hour Timer Recording in AUTO mode to be started, and only 40 minutes tape remaining, the VCR will record in SP for 20 minutes and switch to complete the remaining 40 minutes in LP mode.

## Checking a Preset Recording

You can check your preset recordings:

- ◆ When you have finished presetting the VCR
- ◆ If you have forgotten which programmes will be recorded

- 1 - Press Q-PRO on the remote control or
  - ◆ Press MENU on the remote control.  
Result: The programming menu is displayed.
  - ◆ Press the OK button to select this option.  
Result: The **TIMER-AUFNAHMEN** menu is displayed.
- 2 Press the ▲ or ▼ buttons to select the required programme.
- 3 Press the ◀ or ▶ buttons to select and change any values as required. For more details, refer to the previous page.
- 4 On completion, press MENU twice.

★(SV-6333X/SV-6332X)

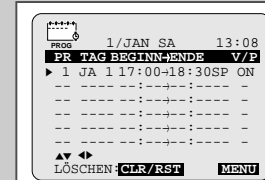

★(SV-2333X/SV-2303X)

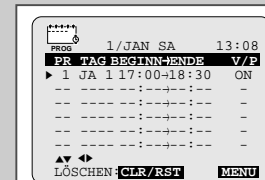

## Cancelling a Preset Recording

You can cancel any programmes that are:

- ◆ Incorrect
- ◆ No longer required

- 1 - Press Q-PRO on the remote control or
  - ◆ Press MENU on the remote control.  
Result: The programming menu is displayed.
  - ◆ Press the OK button to select this option.  
Result: The **TIMER-AUFNAHMEN** menu is displayed.
- 2 Select the programme to be cancelled by pressing the ▲ or ▼ buttons.
- 3 Press the CLR/RST button to cancel the selected programme.  
Result: All the recording information is deleted and the broadcast will not be recorded.
- 4 On completion, press MENU twice.

★(SV-6333X/SV-6332X)

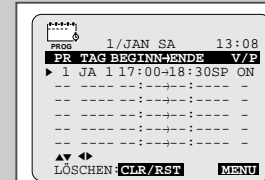

★(SV-2333X/SV-2303X)

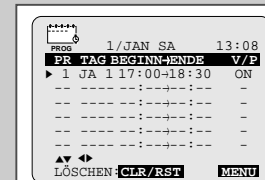



## Playing a Cassette

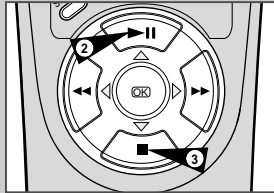

This function allows you to play back any pre-recorded cassette.

- Switch on both the television and your VCR.
  - Insert the video cassette to be played. If the safety tab on the cassette is intact, press **▶||**.  
Otherwise, the cassette is played automatically.
    - When a cassette is loaded, the tape position is optimized automatically to reduce disturbance (Digital Auto Tracking).  
When playing a cassette, if the end of the tape is reached, the cassette is rewound automatically.  
NTSC tapes can be played back but cannot be recorded with this VCR.
- | 3 To...            | Then press... |
|--------------------|---------------|
| Stop the playback  | ■ (STOP).     |
| Eject the cassette | ▲ (EJECT).    |

- **One Touch Play.**  
For your convenience, you can playback tape with a simple touch of the **▶||** (PLAY) button. One Touch Play can be used even when the power is off but a cassette is inserted.

## Adjusting Picture Alignment Manually

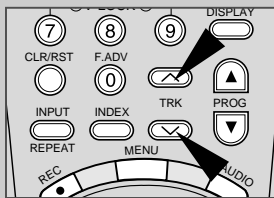

The **Picture Alignment** feature allows you to adjust the alignment manually to obtain the best possible picture.

When noise bars or streaks appear during playback, adjust alignment manually by pressing the TRK (↔) buttons until the picture is clear and stable.

- Result:**
- ◆ The tracking bar appears.
  - ◆ The image is adjusted.
  - ◆ The tracking bar disappears when you release the button.

## Intelligent Picture Control

The **Intelligent Picture Control** Feature allows you to adjust the sharpness of the image automatically, according to your own preferences.

- During playback, press the MENU button on the remote control.  
**Result:** The programming menu is displayed.
- Press the corresponding ▲, ▼ or ◀, ▶ buttons to select the **EINSTELLUNGEN** option.
- Press the OK button to select this option.  
**Result:** The **EINSTELLUNGEN** menu is displayed.
- Press the corresponding ▲ or ▼ buttons, until the cursor is placed in front of the **IPC** option.
- Press the ▶ button to select the IPC (intelligent picture control) option.
  - When intelligent picture control mode is **EIN**, the sharpness of the image is adjusted automatically.
- To adjust the sharpness manually, press the ▼ button to turn the IPC mode **AUS**.
- Press the ◀ or ▶ buttons until the picture is displayed according to your preferences.
  - If you do not press a button within ten seconds, the **BILD** menu disappears automatically.
- On completion, press the MENU button again.

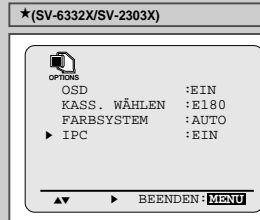
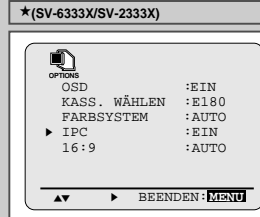

## Intelligent Picture Control

The **Intelligent Picture Control** Feature allows you to adjust the sharpness of the image automatically, according to your own preferences.

- During playback, press the IPC button on the remote control.
- Press the ▼ button to turn the IPC (intelligent picture control) option **EIN** and **AUS**.
  - When intelligent picture control mode is **EIN**, the sharpness of the image is adjusted automatically.
- To adjust the sharpness manually, select intelligent picture control mode **AUS**.
  - The horizontal picture adjusting appears.
- Press the ◀ or ▶ buttons until the picture is displayed according to your preferences.
  - If you do not press a button within ten seconds, the **BILD** menu disappears automatically.
- On completion, press the IPC button again.

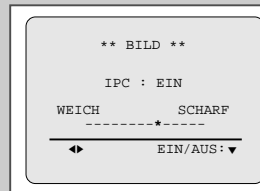

## FORMAT 16:9 (WIDE SCREEN) ★(SV-6333X/SV-2333X Only)

Your VCR can automatically read a 16:9 signal from the AV2 input or a prerecorded 16:9 tape. It can broadcast a 16:9 signal through a 21 pin scart cable.

- Press MENU on the remote control.  
**Result:** The programming menu is displayed.
- Press the corresponding ▲, ▼ or ◀, ▶ buttons to select the **EINSTELLUNGEN** option.
- Press the OK button to select this option.  
**Result:** The **EINSTELLUNGEN** menu is displayed.
- Press the corresponding ▲ or ▼ buttons, until the cursor is placed in front of the **16:9** option.
- Press the ▶ button to select **AUTO** → **EIN** → **AUS**.

<b>AUTO</b>	Set when you use a wide TV. The VCR detects wide TV programmes and normal TV programmes automatically when playing back and recording.
<b>EIN</b>	The VCR always plays back and records in the mode compatible with 16:9 wide screen. Set if the VCR cannot detect wide TV programmes with "AUTO" set.
<b>AUS</b>	Set if you do not use a wide TV.

- On completion, press MENU twice to exit the menu.

## Selecting the Audio Output Mode (SV-6333X/SV-6332X)

You can select the mode in which the sound is reproduced on the loudspeakers and AV outputs. The following options are available.

Option	Description
L	Used to listen to the sound on the left Hi-Fi channel.
R	Used to listen to the sound on the right Hi-Fi channel.
MIX	Used to listen to the mixed sound of the Hi-Fi and normal channels.
MONO	Used to listen to the sound on the normal mono channel.
L R	Used to listen to Hi-Fi stereo sound on the left and right channels. ➤ When playing back tapes recorded in Hi-Fi, the sound switches to Hi-Fi after five seconds of Mono.

To select the sound mode, simply press the AUDIO button on the remote control until the required option is displayed.

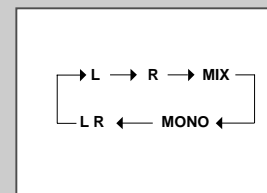
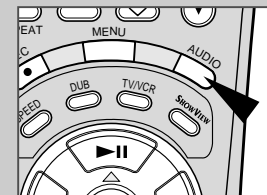

## Selecting the Colour Mode

★(SV-6333X/SV-2333X)

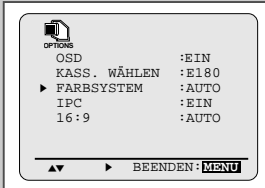

★(SV-6332X/SV-2303X)

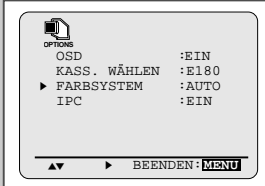

Before recording or playing back a cassette, you can select the required system standard.

Otherwise, the system automatically selects the reception standard when you select AUTO.

- When playing back a cassette, the standard is automatically selected by the VCR.
- When you playback an NTSC-recorded tape on this VCR make a setting on the colour system according to your TV. If your TV is a PAL system only TV, set NTPB. If your TV is Multi System TV (NTSC 4.43 compatible), set NT4.43 and you can record NT4.43.

- Press MENU on the remote control.  
**Result:** The programming menu is displayed.
- Press the corresponding ▲, ▼ or ◀, ▶ buttons to select the **EINSTELLUNGEN** option.
- Press the OK button to select this option.  
**Result:** The **EINSTELLUNGEN** menu is displayed.
- Press the corresponding ▲ or ▼ buttons, until the cursor is placed in front of the **FARBSYSTEM** option.
- Press the ▶ button to select **AUTO** → **PAL** → **MESECAM** → **B/W**.

<b>AUTO</b>	When playing back a cassette, the system standard is automatically selected by the VCR.
<b>B/W</b>	Black and White

- On completion, press MENU twice to exit the menu.

## Selecting the Audio Mute Mode (SV-2333X/SV-2303X)

You can select the mode in which the sound is mute.

To select the audio mute mode on and off, simply press the AUDIO button on the remote control.

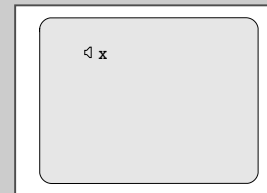
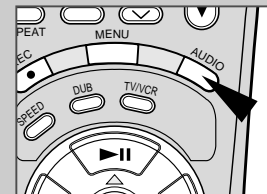

## Playing a Cassette in Slow Motion

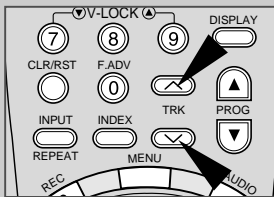
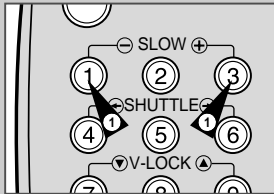

*You can play a cassette in slow motion.*

- No sound is heard when playing back a cassette in slow motion.

- 1 Press:
  - ◆ ►|| to start playing the cassette
  - ◆ SLOW ( ◀ ⊕ ▶ ) as many times as required to decrease or increase the speed respectively
  - ◆ To return to the normal speed, press the ►|| button twice.
- 2 When playing back in slow motion, picture interference may occur. Press the TRK ( ^ or v ) buttons to minimize this effect.

- ☞ When you have been using the Slow Motion function for more than about five minutes, the VCR will automatically play to protect the:
  - ◆ Cassette
  - ◆ Video heads
- Vertical stability: When playing back slow motion, interference may be seen on the screen. Press the V-LOCK ( ◀ ⊕ ▶ ) buttons to minimize this effect.

## Playing a Sequence Frame by Frame

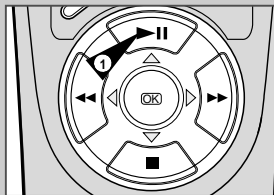

*You can:*

- ◆ Stop the cassette at a given frame (image)
- ◆ Advance one frame at a time

- No sound is heard when playing back frame by frame.

- 1 Press:
  - ◆ ►|| to start playing the cassette
  - ◆ ►|| to stop the tape at a given frame
  - ◆ F.ADV ( ◻ ) to advance frame by frame

- 2 To return to normal playback, press ►||.

- ☞ When you have been using the Frame-by-Frame function for more than about five minutes, the VCR will automatically play to protect the cassette and video heads.
- Vertical stability: When playing back frame by frame, interference may be seen on the screen. Press the V-LOCK ( ◀ ⊕ ▶ ) buttons to minimize this effect.

## Playing a Sequence at Variable Speeds

You can vary the playback speed using the Shuttle function (up to nine times the normal speed).

**Example:** You wish to analyze a sportsperson's technique, movement by movement.

The Shuttle function is available on the Remote control

- No sound is heard when playing a sequence at variable speeds.

- 1 Press:
  - ◆ **▶||** during playback
  - ◆ SHUTTLE (⊖) to play the cassette backwards
  - ◆ SHUTTLE (⊕) to play the cassette forwards
- 2 Each time you press a SHUTTLE (⊖/⊕) button, the speed is changed as shown in the following illustration.

REVERSE PLAY X9	REVERSE PLAY X7	REVERSE PLAY X3	STILL	SLOW MOTION X1/10	SLOW MOTION X1/5	PLAY	PLAY X3	PLAY X7	PLAY X9
-----------------------	-----------------------	-----------------------	-------	-------------------------	------------------------	------	------------	------------	------------

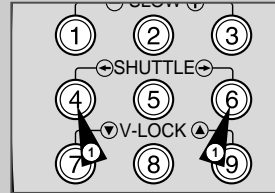

## Searching for a Specific Sequence

Each time you record a cassette on this VCR, an "index" is automatically marked on the tape when recording starts.

The Search function allows you to fast-forward or rewind to a specific index and start playback from that point. Depending on the direction selected, the indexes are numbered as follows:

	↓			
etc.	Prev Seq.	Seq. being played	Next Seq.	etc.
	2	1	1	2

- This VCR uses a standard indexing system (VISS). As a result, it will recognize any indexes marked by other VCRs using the same system and vice versa.

- 1 To search for a specific index, press INDEX.
- 2 Press the ◀ or ▶ buttons depending on the direction where your desired programme is located. Each time you press the ◀ or ▶ buttons, the number decreases or increases respectively.  
**Result:** The index number is displayed.
- 3 The VCR starts to search for the point you specified with the ◀ or ▶ buttons.  
**Result:** When the index is found, cassette playback starts.

- You can set an index number up to ±20.

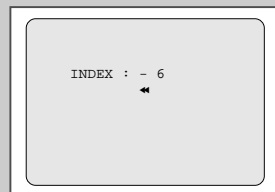
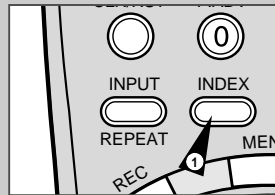

## Auto Repeat Play

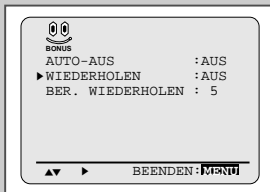

You can set repeat play to repeat the tape continuously from beginning to end.

- 1 Press MENU on the remote control.  
**Result:** The programming menu is displayed.
- 2 Press the corresponding ▲, ▼ or ◀, ▶ buttons to select the **ZUSATZFUNKTIONEN** option.
- 3 Press the OK button to select this option.  
**Result:** The **ZUSATZFUNKTIONEN** menu is displayed.
- 4 Press the corresponding ▲ or ▼ buttons, until the cursor is placed in front of the **WIEDERHOLEN** option.
- 5 **To...** Press ◀ or ▶, until...  
Repeat play **EIN** is displayed.  
Do not wish to repeat play **AUS** is displayed.
- 6 On completion, press MENU twice to exit the menu.

## Interval Repeat Play



You can set interval repeat play to repeat the cassette several times for special interval.

- 1 Press MENU on the remote control.  
**Result:** The programming menu is displayed.
- 2 Press the corresponding ▲, ▼ or ◀, ▶ buttons to select the **ZUSATZFUNKTIONEN** option.
- 3 Press the OK button to select this option.  
**Result:** The **ZUSATZFUNKTIONEN** menu is displayed.
- 4 Press the corresponding ▲ or ▼ buttons, until the cursor is placed in front of the **BER. WIEDERHOLEN** option.
- 5 **To...** Press ▶, until...  
Interval repeat play 5, 10, 15 is displayed.  
(choose repeat time 5 times, 10 times, 15 times)  
Cancel interval repeat play **AUS** is displayed.
- 6 On completion, press MENU twice to exit the menu.
- 7 To select interval during playback, press the INPUT/REPEAT button at the desired start point.  
**Result:** "INTERVAL REPEAT SETTING" is displayed.  
Press the INPUT/REPEAT button one more time at the desired end point.  
**Result:** The tape is automatically rewound to the start point.  
"INTERVAL REPEAT" is displayed.

## Using the Tape Counter

The tape counter:

- ◆ Indicates the elapsed time in the play and record modes (hours, minutes and seconds)
- ◆ Is reset when a cassette is inserted in the VCR
- ◆ Allows you to find the beginning of a sequence easily



If the remaining time is to be calculated correctly, you must indicate the type of cassette being used.

- 1 Insert a cassette in your VCR.
- 2 To set the tape counter to zero at the beginning of a sequence:
  - ◆ Press DISPLAY twice to display the counter
  - ◆ Press CLR/RST when you want to set the tape counter to zero
- 3 To fast-forward or rewind to the sequence at which the counter was set to zero, simply press ◀◀ or ▶▶.  
**Result:** The VCR stops automatically when the counter reaches zero.



Some VCR information, such as the counter, can be displayed on the television screen (unless you have deactivated the OSD mode; refer to page 16).

Press DISPLAY:

- ◆ Once to display the current function, programme number, recording speed \*(SV-6333X/SV-6332X only), date, time and counter
- ◆ Twice to display the counter only
- ◆ Three times to display the time remaining on the cassette
- ◆ Four times to clear the display

GB

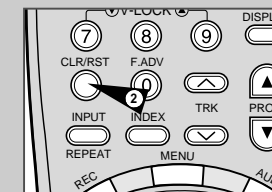
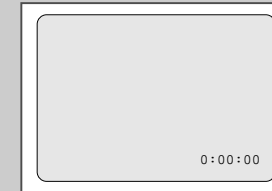

## Using the Assemble Edit Function

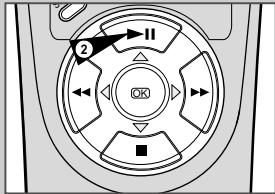

*This function allows you to start a new recording at a specific position on the cassette while maintaining a very smooth scene change.*

- 1 Insert the cassette to be edited in your VCR.
- 2 Press the ►|| button to start playback.
- 3 When you reach the position from which you wish to start the new recording, press the ►|| button.
- 4 Press the F.ADV (Ⓜ) button again as often as necessary to advance frame by frame, until the exact recording position is located.
- 5 While the VCR is in still mode, hold the REC button (●) down for a while to activate the Assemble Edit function.  
**Result:** Record symbol flashes in the display.
- 6 Select the source from which you wish to record by pressing:
  - ◆ The PROG (▲ or ▼) buttons for television channels
  - ◆ The INPUT button for the AV1 or AV2 ★(SV-6333X/SV-2333X only) input sources
- 7 Press the ►|| button to start recording.
- 8 When you have finished recording, press ■.

## Recording from Another VCR or Camcorder

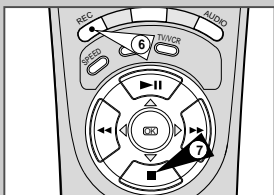
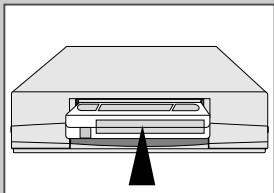

*You can copy a cassette to your VCR from another video source, such as another VCR or a camcorder.*

☞ It is an infringement of copyright laws to copy prerecorded cassettes or to re-record them in any form without the permission of the owners of the corresponding copyright.

- 1 Connect the VCR, from which the cassette is to be copied, to the appropriate SCART audio and video input connectors on the rear of your VCR, as indicated on page 12.
- 2 Insert a blank cassette in your VCR.
- 3 Insert the pre-recorded cassette in the other video source (VCR or camcorder).
- 4 Press the INPUT button to select the appropriate input on your VCR:
  - ◆ AV1 or AV2 ★(SV-6333X/SV-2333X only) for the SCART input
- 5 Start playing back the cassette to be copied.
- 6 Hold REC (●) down for a while to start recording on your VCR.
- 7 When you have finished recording, press ■ on both VCRs.

➤ If you wish to view the cassette being copied:
 

- ◆ Your VCR must be connected as usual to the television (see page 12 for further details)

## Auto Power Off

*The Auto Power Off feature automatically turns off your VCR if no signal is received and you do not press any button for the selected time.*

- 1 Press MENU on the remote control.  
**Result:** The programming menu is displayed.
- 2 Press the corresponding ▲, ▼ or ◀, ▶ buttons to select the ZUSATZFUNKTIONEN option.
- 3 Press the OK button to select this option.  
**Result:** The ZUSATZFUNKTIONEN menu is displayed.
- 4 Press the corresponding ▲ or ▼ buttons, until the cursor is placed in front of the AUTO-AUS option.
- 5 Press the ▶ button, until you select the time of Auto Power off interval.  
 ➤ AUS → 2HOUR → 3HOUR ➤
- 6 On completion, press MENU twice to exit the menu.

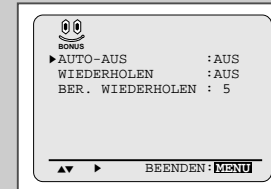

## Technical Specifications

Design and specifications are subject to change without notice.

MODEL	SV-6333X/SV-6332X	SV-2333X/SV-2303X
Format Heads	VHS PAL standard Video: 4 rotary heads Hi-Fi audio: 2 rotary heads	VHS PAL standard Video: 2 rotary heads
Receiving channel	Audio/Control: 1 stationary head Erase: 1 full track erase head VHF-I, VHF-III, UHF, Interband/ Hyperband	Audio/Control: 1 stationary head Erase: 1 full track erase head VHF-I, VHF-III, UHF, Interband/ Hyperband
Television system Luminance Colour system	STANDARD B/G-D/K A2 STEREO FM azimuth recording PAL/MESECAM/NT4.43: Down converted subcarrier phase shifted direct recording	STANDARD B/G FM azimuth recording PAL/MESECAM/NT4.43: Down converted subcarrier phase shifted direct recording
Tape speed	NTSC PB on PAL TV SP 23.39 mm/sec LP 11.69 mm/sec	NTSC PB on PAL TV 23.39 mm/sec
Recording/playback time	SP 3 hours (E-180 Tape) LP 6 hours (E-180 Tape)	3 hours (E-180 Tape)
REW time	About 60 sec in REW with E-180	About 100 sec in REW with E-180
<b>VIDEO</b> Input Output Signal-to-noise ratio Horizontal resolution	0.5 to 2.0 Vp-p; 75 ohm unbalanced 1.0 ± 0.2 Vp-p; 75 ohm unbalanced Better than 43 dB (SP) More than 240 lines (SP)	0.5 to 2.0 Vp-p; 75 ohm unbalanced 1.0 ± 0.2 Vp-p; 75 ohm unbalanced Better than 43 dB More than 240 lines
<b>AUDIO</b> Input Output Wow and flutter (WTD) Signal-to-noise ratio Frequency response	-8 dBm, 47 Kohm unbalanced -8 ± 3 dBm, 1 Kohm unbalanced 0.4% max (SP) 68 dB min (IHF A filter) 20Hz - 20kHz	-8 dBm, 47 Kohm unbalanced -8 ± 3 dBm, 1 Kohm unbalanced 0.4% max 42 dB min (IHF A filter)
Power requirement Power consumption Operation temperature Operation humidity Weight Dimensions (WxHxD)	AC 230V 50/60 Hz Approx. 17 watts 41°F-104°F (5°C-40°C) 10%-75% 3.3 Kg (net) 360 x 94 x 285 mm	AC 230V 50/60 Hz Approx. 15 watts 41°F-104°F (5°C-40°C) 10%-75% 3.3 Kg (net) 360 x 94 x 285 mm

## Problems and Solutions

Before contacting the Samsung after-sales service, perform the following simple checks.

Problem	Explanation/Solution
No power	<ul style="list-style-type: none"> <li>Check that the power plug is connected to a wall outlet.</li> <li>Have you pressed the STANDBY/ON button?</li> </ul>
You cannot insert a video cassette	<ul style="list-style-type: none"> <li>A video cassette can only be inserted with the window side up and the safety tab facing you.</li> </ul>
The television programme was not recorded	<ul style="list-style-type: none"> <li>Check the VCR aerial connections.</li> <li>Is the VCR tuner properly set?</li> <li>Check if the safety tab is intact on the cassette.</li> </ul>
Timer recording was unsuccessful	<ul style="list-style-type: none"> <li>Was the STANDBY/ON button pressed to activate the timer?</li> <li>Re-check the recording start/stop time settings.</li> <li>If there was a power failure or interruption during timer recording, the recording will have been cancelled.</li> </ul>
No playback picture or the picture is distorted	<ul style="list-style-type: none"> <li>Check to see if you are using a prerecorded tape.</li> </ul>
You cannot see normal broadcasts	<ul style="list-style-type: none"> <li>Check the TUNER/EXTERNAL setting. It should be on TUNER.</li> <li>Check the TV/VCR aerial connections.</li> </ul>
Noise bars or streaks on playback	<ul style="list-style-type: none"> <li>Press the TRK ( ^ or v ) buttons to minimize this effect.</li> </ul>
When the ►   button is pressed during playback, the still picture has severe "noise bars" streaks	<ul style="list-style-type: none"> <li>A still picture may have "noise bars", depending on the condition of the tape. Press the TRK ( ^ or v ) buttons during SLOW motion to minimize this effect.</li> </ul>
Video Head Cleaning	<ul style="list-style-type: none"> <li>If poor pictures appear on a variety of cassettes, the video heads may need cleaning. This is not a common problem and unless it appears, the heads should not be cleaned. When cleaning the video heads, read all instructions provided with the head cleaning cassette. Incorrect head cleaning can permanently damage the video heads.</li> </ul>
If when tuning in your TV to the VCR test pattern your TV does not find the test pattern or the pattern when found suffers from interference, it may be due to the VCR output channel clashing with the normal TV transmissions in your area. To prevent this you will need to change the VCR output channel in the following way	<ol style="list-style-type: none"> <li>Remove the aerial input plug from the socket marked (aerial symbol) on the rear of the VCR.</li> <li>Carry out the instructions "Tuning Your Television for the VCR" (see page 14).</li> <li>Carry out the instructions "Setting the VCR output Channel" (see page 17), move the channel number several channels down from the original setting. (example: from 36 to 33).</li> <li>Replace the aerial plug into the socket marked (aerial symbol) on the rear of the VCR.</li> <li>Re-tune your TV to the VCR again by following instructions "Tuning Your Television for the VCR" (page 14).</li> <li>If the problem still exists repeat steps 1 to 5 moving several more channels away from the original setting.</li> </ol>

If you are unable to solve the problem after reading the above instructions, note:

- The model and serial number on the rear of your VCR
- The warranty information
- A clear description of the problem

Then contact your nearest SAMSUNG after-sales service.

## TV Frequency Table (System-B/G)

002-012 :CCIR STD VHF    244-250 :MOROCCO  
 013-020 :ITALY            251-255 :BELGIUM  
 021-069 :CCIR STD UHF  
 071-075 :CCIR CABLE  
 201-241 :CCIR STD CABLE

Germany	Netherlands	Belgium	Morocco
Spain	Denmark	Greece	Yugoslavia
Italy	Finland	Portugal	
Austria	Norway	Slovenia	
Switzerland	Sweden	Croatia	

DISP	CH	Band	Fp	STD	DISP	CH	Band	Fp	STD	DISP	CH	Band	Fp	STD
002	E02	V-L	48.25	CCIR	060	E60	UHF	783.25	CCIR	246	M6	V-H	179.25	Morocco
003	E03	V-L	55.25	CCIR	061	E61	UHF	791.25	CCIR	247	M7	V-H	187.25	Morocco
004	E04	V-L	62.25	CCIR	062	E62	UHF	799.25	CCIR	248	M8	V-H	195.25	Morocco
005	E05	V-H	175.25	CCIR	063	E63	UHF	807.25	CCIR	249	M9	V-H	203.25	Morocco
006	E06	V-H	182.25	CCIR	064	E64	UHF	815.25	CCIR	250	M10	V-H	211.25	Morocco
007	E07	V-H	189.25	CCIR	065	E65	UHF	823.25	CCIR	251	U1	V-H	226.25	Belgium
008	E08	V-H	196.25	CCIR	066	E66	UHF	831.25	CCIR	252	U2	V-H	234.25	Belgium
009	E09	V-H	203.25	CCIR	067	E67	UHF	839.25	CCIR	253	U3	V-H	242.25	Belgium
010	E10	V-H	210.25	CCIR	068	E68	UHF	847.25	CCIR	254	U4	V-H	250.25	Belgium
011	E11	V-H	217.25	CCIR	069	E69	UHF	855.25	CCIR	255	U5	V-H	258.25	Belgium
012	E12	V-H	224.25	CCIR	071	X	V-L	69.25	CCIR					
013	A	V-L	53.75	Italy	072	Y	V-L	76.25	CCIR					
014	B	V-L	62.25	Italy	073	Z	V-L	83.25	CCIR					
015	C	V-L	82.25	Italy	074	Z+1	V-L	90.25	CCIR					
016	D	V-H	175.25	Italy	075	Z+2	V-L	97.25	CCIR					
017	E	V-H	183.25	Italy	201	S01	V-L	105.25	CCIR					
018	F	V-H	192.25	Italy	202	S02	V-L	112.25	CCIR					
019	G	V-H	201.25	Italy	203	S03	V-L	119.25	CCIR					
020	H	V-H	210.25	Italy	204	S04	V-L	126.25	CCIR					
021	E21	UHF	471.25	CCIR	205	S05	V-L	133.25	CCIR					
022	E22	UHF	479.25	CCIR	206	S06	V-L	140.25	CCIR					
023	E23	UHF	487.25	CCIR	207	S07	V-H	147.25	CCIR					
024	E24	UHF	495.25	CCIR	208	S08	V-H	154.25	CCIR					
025	E25	UHF	503.25	CCIR	209	S09	V-H	161.25	CCIR					
026	E26	UHF	511.25	CCIR	210	S10	V-H	168.25	CCIR					
027	E27	UHF	519.25	CCIR	211	S11	V-H	175.25	CCIR					
028	E28	UHF	527.25	CCIR	212	S12	V-H	182.25	CCIR					
029	E29	UHF	535.25	CCIR	213	S13	V-H	189.25	CCIR					
030	E30	UHF	543.25	CCIR	214	S14	V-H	196.25	CCIR					
031	E31	UHF	551.25	CCIR	215	S15	V-H	203.25	CCIR					
032	E32	UHF	559.25	CCIR	216	S16	V-H	210.25	CCIR					
033	E33	UHF	567.25	CCIR	217	S17	V-H	217.25	CCIR					
034	E34	UHF	575.25	CCIR	218	S18	V-H	224.25	CCIR					
035	E35	UHF	583.25	CCIR	219	S19	V-H	231.25	CCIR					
036	E36	UHF	591.25	CCIR	220	S20	V-H	238.25	CCIR					
037	E37	UHF	599.25	CCIR	221	S21	V-H	245.25	CCIR					
038	E38	UHF	607.25	CCIR	222	S22	V-H	252.25	CCIR					
039	E39	UHF	615.25	CCIR	223	S23	V-H	259.25	CCIR					
040	E40	UHF	623.25	CCIR	224	S24	V-H	266.25	CCIR					
041	E41	UHF	631.25	CCIR	225	S25	V-H	273.25	CCIR					
042	E42	UHF	639.25	CCIR	226	S26	V-H	280.25	CCIR					
043	E43	UHF	647.25	CCIR	227	S27	V-H	287.25	CCIR					
044	E44	UHF	655.25	CCIR	228	S28	V-H	294.25	CCIR					
045	E45	UHF	663.25	CCIR	229	S29	V-H	301.25	CCIR					
046	E46	UHF	671.25	CCIR	230	S30	V-H	308.25	CCIR					
047	E47	UHF	679.25	CCIR	231	S31	V-H	315.25	CCIR					
048	E48	UHF	687.25	CCIR	232	S32	V-H	322.25	CCIR					
049	E49	UHF	695.25	CCIR	233	S33	V-H	329.25	CCIR					
050	E50	UHF	703.25	CCIR	234	S34	V-H	336.25	CCIR					
051	E51	UHF	711.25	CCIR	235	S35	V-H	343.25	CCIR					
052	E52	UHF	719.25	CCIR	236	S36	V-H	350.25	CCIR					
053	E53	UHF	727.25	CCIR	237	S37	UHF	357.25	CCIR					
054	E54	UHF	735.25	CCIR	238	S38	UHF	364.25	CCIR					
055	E55	UHF	743.25	CCIR	239	S39	UHF	371.25	CCIR					
056	E56	UHF	751.25	CCIR	240	S40	UHF	378.25	CCIR					
057	E57	UHF	759.25	CCIR	241	S41	UHF	385.25	CCIR					
058	E58	UHF	767.25	CCIR	244	M4	V-H	163.25	Morocco					
059	E59	UHF	775.25	CCIR	245	M5	V-H	171.25	Morocco					

THIS APPLIANCE IS DISTRIBUTED BY



[www.samsungvcr.com](http://www.samsungvcr.com)

AC68-00486A



## Free Manuals Download Website

<http://myh66.com>

<http://usermanuals.us>

<http://www.somanuals.com>

<http://www.4manuals.cc>

<http://www.manual-lib.com>

<http://www.404manual.com>

<http://www.luxmanual.com>

<http://aubethermostatmanual.com>

Golf course search by state

<http://golfingnear.com>

Email search by domain

<http://emailbydomain.com>

Auto manuals search

<http://auto.somanuals.com>

TV manuals search

<http://tv.somanuals.com>