

SAMSUNG

Operating Instructions

VACUUM CLEANER

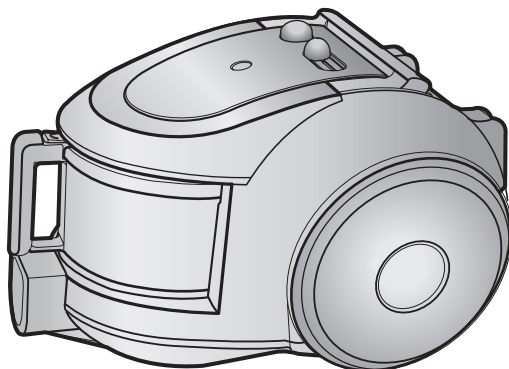

- * Before operating this unit, please read the instructions carefully.
- * Indoor use only.

Register your product at www.samsung.com/global/register

IMPORTANT SAFEGUARDS

1. Read all instructions carefully. Before switching on, make sure that the voltage of your electricity supply is the same as that indicated on the rating plate on the bottom of the cleaner.
2. **WARNING:** Do not use the vacuum cleaner when rug or floor is wet.
Do not use to suck up water.
3. Close supervision is necessary when any appliance is used by or near children. Do not allow the vacuum cleaner to be used as a toy. Do not allow the vacuum cleaner to run unattended at any time. Use the vacuum cleaner only for its intended use as described in these instructions.
4. Do not use the vacuum cleaner without a dust bin. Empty the dust bin before it is full in order to maintain the best efficiency.
5. Do not use the vacuum cleaner to pick up matches, live ashes or cigarette butts. Keep the vacuum cleaner away from stoves and other heat sources. Heat can deform and discolour the plastic parts of the unit.
6. Avoid picking up hard, sharp objects with the vacuum cleaner as they may damage the cleaner parts. Do not stand on the hose assembly. Do not put weight on the hose. Do not block the suction or the exhaust port.
7. Switch the vacuum cleaner off on the body of the machine before unplugging from the electrical outlet. Disconnect the plug from the electrical outlet before changing the dust bag or dust container. To avoid damage, please remove the plug by grasping the plug itself, not by pulling on the cord.
8. This appliance is not intended for use by young persons or infirm persons without supervision unless they are adequately supervised by a responsible person to ensure that they can use the appliance safely.
Young children should be supervised to ensure that they do not play with the appliance.
9. The plug must be removed from the socket outlet before cleaning or maintaining the appliance.
10. The use of an extension cord is not recommended.
11. If your vacuum cleaner is not operating correctly, switch off the power supply and consult an authorized service agent.
12. If the supply cord is damaged, it must be replaced by the manufacturer or its service agent or a similarly qualified person in order to avoid a hazard.
13. Don't carry the vacuum cleaner by holding the hose.
Use the handle on the vacuum cleaner set.

1 ASSEMBLING THE CLEANER

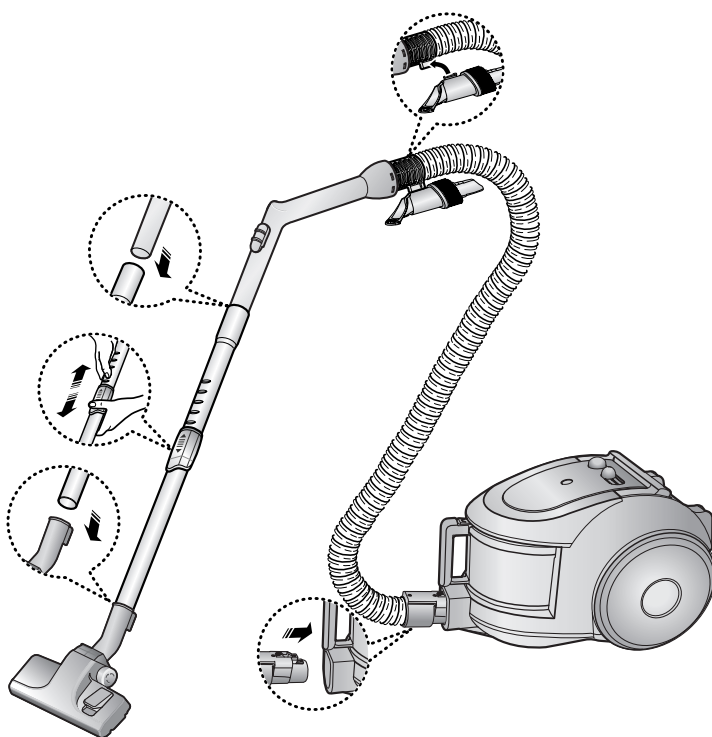

OPTION

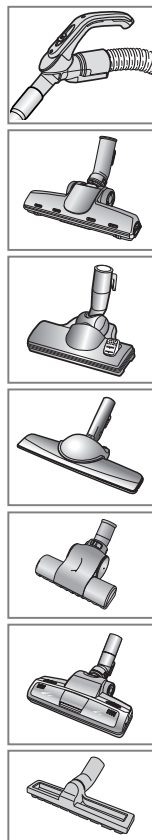

► Features may vary according to model.

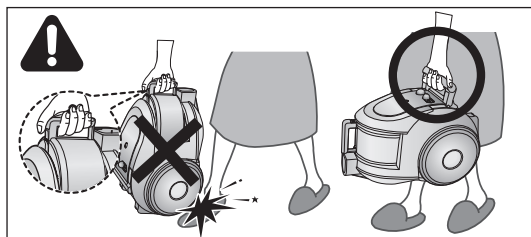

CAUTION

Please do not press the button of dust bin handle when carrying machine.

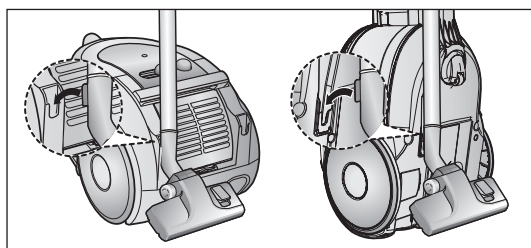

For storage, park the floor nozzle.

2 OPERATING THE CLEANER

2-1 ON/OFF SWITCH

1) BODY CONTROL TYPE

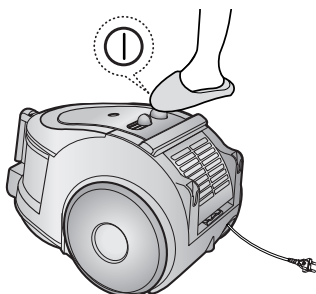

2) ON/OFF TYPE

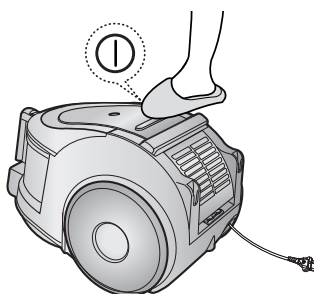

2-2 POWER CORD

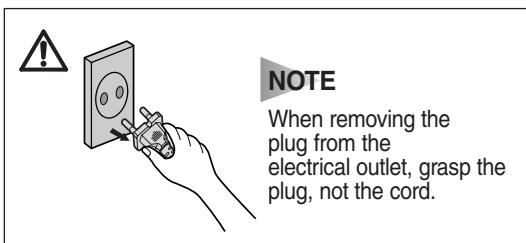
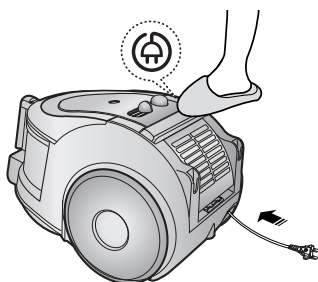

2-3 POWER-CONTROL

1) SLIDE CONTROL TYPE ONLY (Optional)

- **SLIDE TO THE STOP POSITION**
Vacuum-cleaner switches off (stand by mode)
- **SLIDE FORWARD TO MAX**
Suction capacity increases smoothly up to maximum.

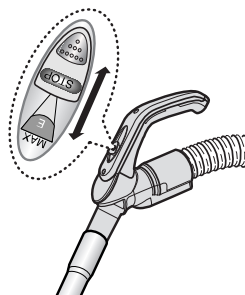

2) BODY-CONTROL TYPE / ON/OFF TYPE

- HOSE

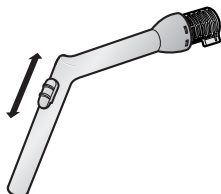

To reduce suction for cleaning draperies, small rugs, and other light fabrics, pull the tap air until the hole is open.

- BODY (BODY-CONTROL TYPE ONLY)

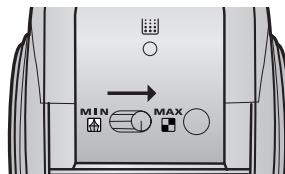





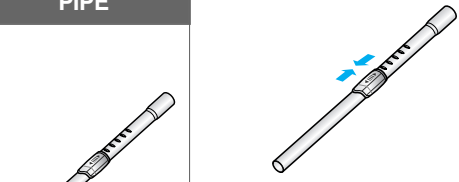
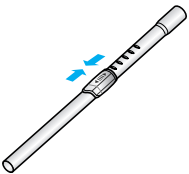
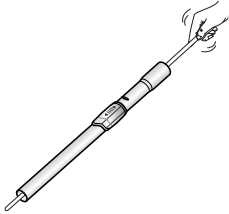

MIN = For delicate surface e.g. net curtains.

MAX = For hard floors and heavily soiled carpets.

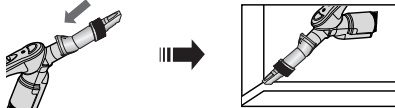
2-4 HOW TO USE AND MAINTAIN THE ACCESSORIES

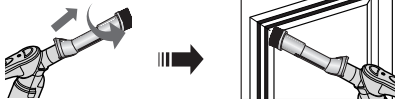

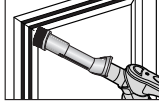
► Features may vary according to model.

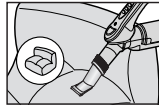

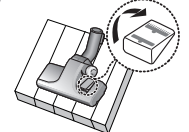
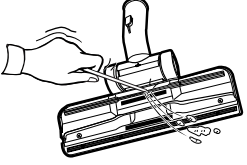
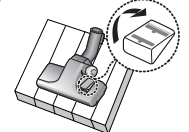
<p>PIPE</p> 	 <p>Adjust the length of the telescopic pipe by sliding the length control button located in the center of the telescopic pipe back and forth.</p>	 <p>To check for blockages, separate the telescopic pipe and adjust to shorten. This allows for easier removal of waste clogging the tube.</p>
------------------------------------------------------------------------------------------------------	-------------------------------------------------------------------------------------------------------------------------------------------------------------------------------------------------------------------------------------	---------------------------------------------------------------------------------------------------------------------------------------------------------------------------------------------------------------------------------

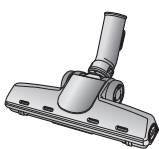
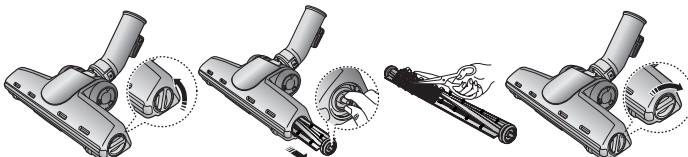
<p>ACCESSORY</p> 		 <p>Push the accessory on to the end of the hose handle.</p>
		 <p>Pull out and turn the dusting brush for cleaning delicate areas.</p>
		 <p>To use the upholstery tool, push the accessory on to the end of the hose handle in the opposite direction.</p>

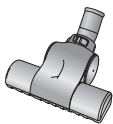
<p>OPTION</p> 	<p>► Carpet Cleaning</p> 	 <p>Remove waste matter completely if the inlet is blocked.</p>
	<p>► Floor Cleaning</p>  <p>Adjust the inlet lever according to the floor surface.</p>	

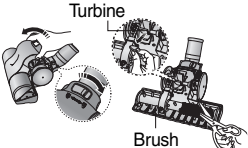
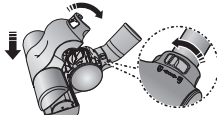
OPTION	- Detach transparent drum cover for easy cleaning.
	

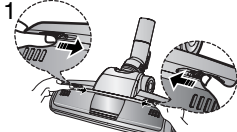
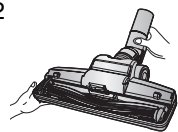
OPTION	Clogs on turbine keep brush from turning, thus need to be unlogged as follows.		
 Brush for blanket For picking up pet hair and fibre on upholstery and bed linen.	 Remove waste matter completely when inlet is blocked.	 Turn the lock button to 'UNLOCK', and remove waste matter.	 To reassemble, align the cover to the front of the main body and close. After closing the cover, ensure that the lock button is turned to the 'LOCK' position.
	Warning : Use for bedclothes only. Be cautious not to damage brush during unlogging.		

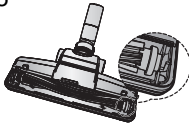
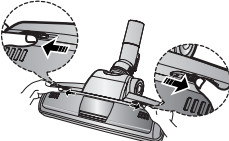
OPTION	Frequent vacuuming of hair or pet fur may cause a falling-off of the rotation due to matters tangled around the drum. In this case, clean the drum with care.					
 For improved pick-up of pet hair and fibre on carpets	 1 Push the Open button of the transparent screen cover to separate the cover.	 2 Remove the brushbar from the transparent screen.	 3 Remove waste matter such as dust and hair tangled around the brushbar using scissors.	 4 Remove dust inside the brush housing using a dry duster or crevice tool.	 5 Insert brushbar into rotating belt and assemble.	 6 Click the transparent screen cover back into place to reassemble.

3 EMPTYING THE DUST BIN

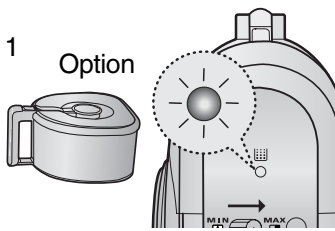

Once dust reaches the dust full mark, or once the dust full light is on, empty the dust bin.

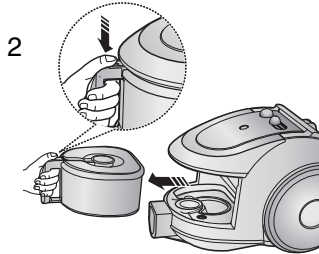

Take the dust bin out by pressing the button.

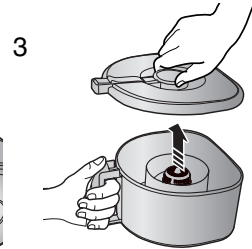

Separate the dust bin cover.

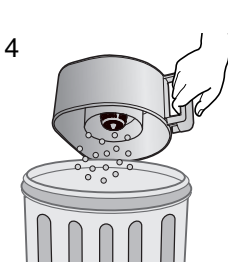

Throw away dust into the bin.

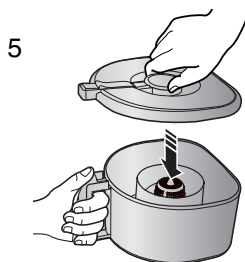

Close the dust bin cover.

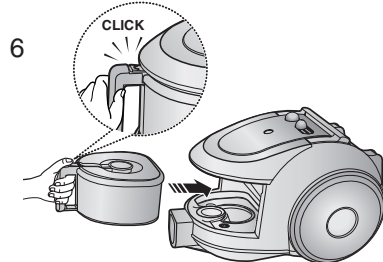

Before use, push the dust bin into the main body of the vacuum cleaner until you hear the "click" sound.

- Empty into a plastic bag (recommended for asthma/allergy sufferers)

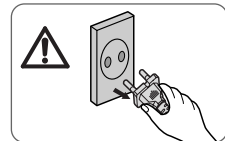
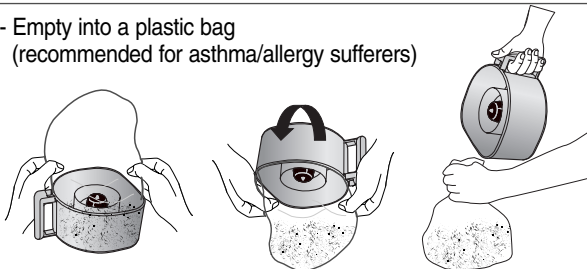

NOTE

You may rinse the dust bin with cold water



4 CLEANING THE DUST PACK

4-1. WHEN TO CLEAN THE DUST PACK

- If suction is noticeably reduced during cleaning, please check the dust pack as indicated below.

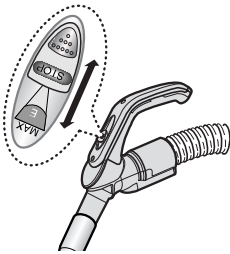

HANDLE CONTROL

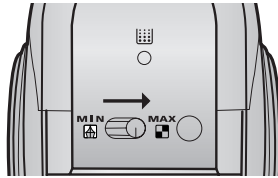

Turn the vacuum power to 'MAX'

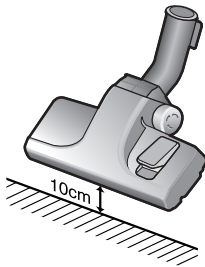

If the filter check indicator turns red with the inlet floating 10 cm above flat floor, clean it.

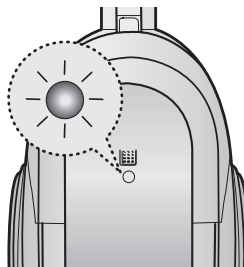
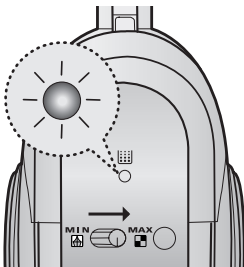

When the indicator light comes on, please empty the Dust Pack(4-2) as shown in the following illustrations.

4-2 CLEANING THE DUST PACK

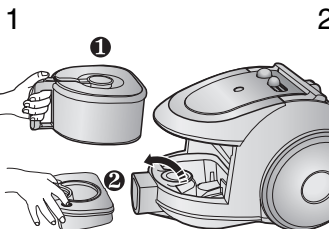

Remove the dust bin and dust pack as shown.

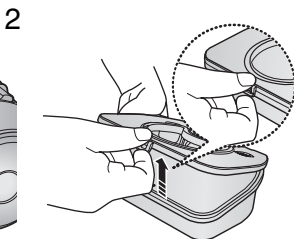

Remove the fixed frame of the dust pack cover.

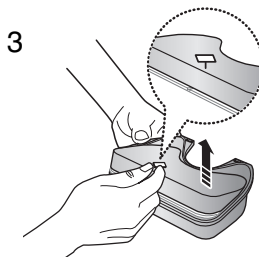

Remove the sponge and filter from the dust pack.

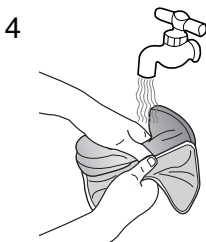

Wash the sponge and the filter of the dust pack with water.

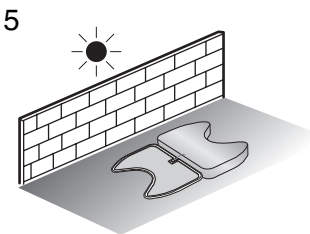

Let the sponge and filter dry in the shade for more than 12 hours.

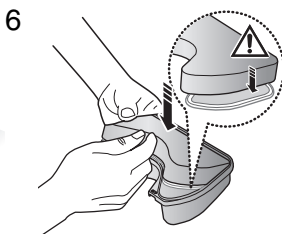

Put the sponge and filter into the dust pack.

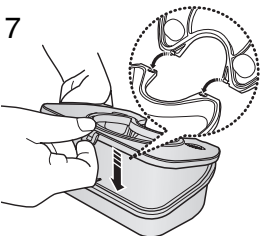

Before reassembly, align the dust pack cover and dust pack correctly.

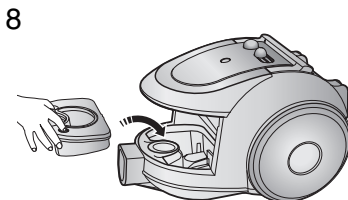

Put the assembled dust pack into the main body.



NOTE : Make sure the filter is completely dry before putting it back into the vacuum cleaner. Allow 12 hours for it to dry.

5 CLEANING THE MOTOR PROTECTION FILTER

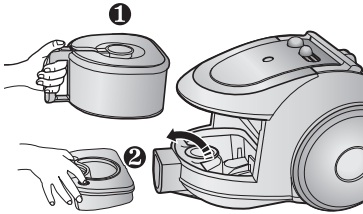

Take out both the dust bin and the dust pack.

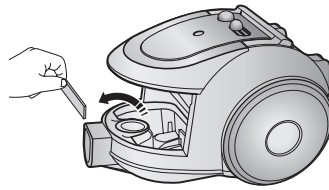

Remove the motor protection filter from the vacuum cleaner. Shake and tap the dust from it and put back in machine.

6 CLEANING THE OUTLET FILTER

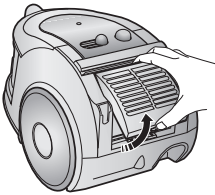

Press the fixed frame part at the back of the main body to remove.

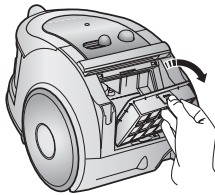

Pull out the HEPA Filter using the tab.

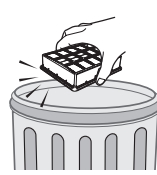

Dust the HEPA filter.

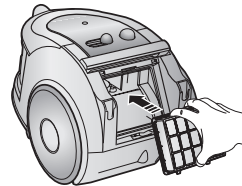

Put the HEPA filter into the main body until you hear a 'click' sound.

OPTION - MICRO CARBON FILTER

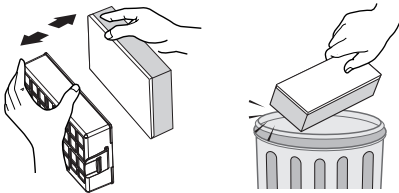

Remove and replace the blocked outlet filter.

NOTE : Replacement filters are available at your local Samsung distributor.

- IF YOU HAVE A PROBLEM

PROBLEM	CAUSE	REMEDY
Motor does not start.	No power supply. Thermal cut-out.	Check cable, plug and socket. Leave to cool.
Suction force is gradually decreasing.	Nozzle, suction hose or tube is blocked.	Check for blockage and remove it.
Cord does not rewind fully.	Check that the cord is not twisted or wound unevenly.	Pull the cord out 2-3m and push the cord rewind button.
Vacuum cleaner does not pick up dirt.	Crack or hole in hose.	Check hose and replace if required.
Low or decreasing suction	Filter is full of dust.	Please check filter and, if necessary, clean as illustrated in the instructions.



If you have any questions or comments relating to Samsung products, please contact the SAMSUNG customer care center.

Country	Customer Care Center ☎	Web Site
AUSTRALIA	1300 362 603	www.samsung.com/au
HONG KONG	3698-4698	www.samsung.com/hk
MALAYSIA	1800-88-9999	www.samsung.com/my
SINGAPORE	1800-SAMSUNG (7267864)	www.samsung.com/sg

Free Manuals Download Website

<http://myh66.com>

<http://usermanuals.us>

<http://www.somanuals.com>

<http://www.4manuals.cc>

<http://www.manual-lib.com>

<http://www.404manual.com>

<http://www.luxmanual.com>

<http://aubethermostatmanual.com>

Golf course search by state

<http://golfingnear.com>

Email search by domain

<http://emailbydomain.com>

Auto manuals search

<http://auto.somanuals.com>

TV manuals search

<http://tv.somanuals.com>