

SAMSUNG

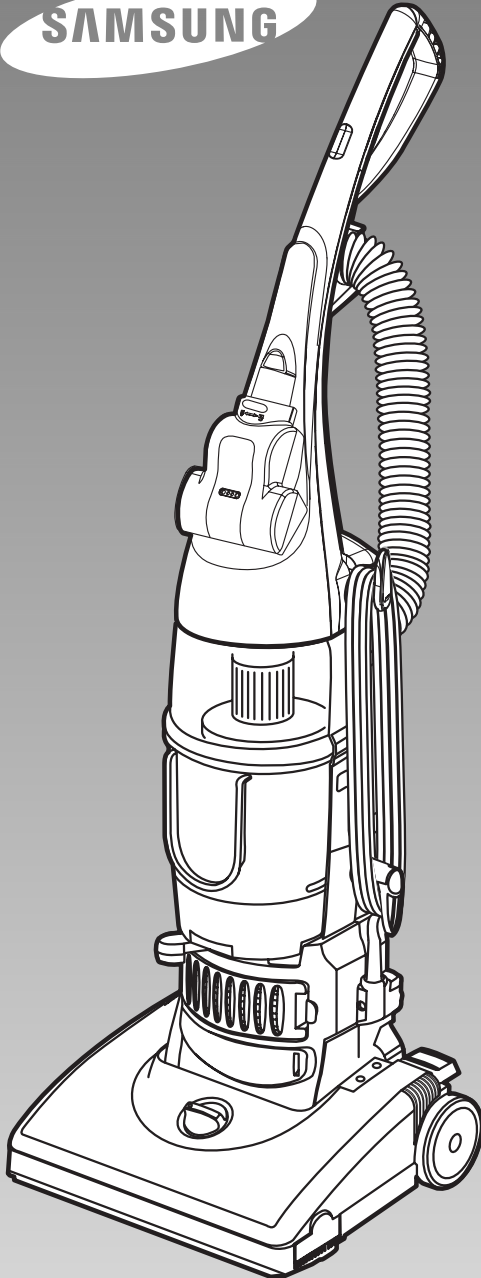

Vacuum Cleaner

SU-2930 Series
FOR HOUSEHOLD USE ONLY

Operating Instructions

IMPORTANT SAFETY INSTRUCTIONS	1
ASSEMBLING PARTS	2
OPERATION	3
MAINTENANCE	5
TROUBLESHOOTING	8

Read these instructions before operating the vacuum cleaner

•The design and specification may be different depending on the models.

Register your product at www.samsung.com/global/register

IMPORTANT SAFETY INSTRUCTIONS

Thank you for purchasing a Samsung vacuum cleaner. When using an electrical appliance, basic precautions should always be followed, including the following:

PLEASE READ ALL INSTRUCTIONS BEFORE USING THIS VACUUM CLEANER.

WARNING: To reduce the risk of fire, electric shock, or injury:

- Do not leave vacuum cleaner unattended when it is plugged in.
- Unplug from outlet when not in use and before servicing.
- Do not use outdoors or on wet surfaces.
- This appliance is not intended for use by young children or infirm persons without supervision. Young children should be supervised to ensure that they do not play with the appliance.
- Use only as described in this manual. Use only manufacturer's recommended attachments.
- Do not use with damaged cord or plug.
- If vacuum cleaner is not working as it should, or has been dropped, damaged, left outdoors or dropped in water, take it to a service center.
- Do not pull or carry by cord, use cord as a handle, close a door on cord, or pull the cord around sharp edges or corners. Keep cord away from heated surface.
- Do not unplug by pulling on the cord. To unplug, grasp the plug, not the cord.
- Do not handle vacuum cleaner or plug with wet hands.
- Do not put any object into openings. Do not use with any opening blocked; keep openings free of dust, lint, hair and anything that may reduce air flow.
- Keep hair, loose clothing, fingers and all parts of body away from openings and moving parts.
- Do not pick up anything that is burning or smoking, such as cigarettes, matches or hot ashes.
- Do not use without dirt cup or filters in place. Empty cup and clean filter frequently when picking up very fine materials such as powder.
- Turn off all controls before unplugging vacuum cleaner.
- Use extra care when cleaning on stairs.
- Do not use to pick up flammable or combustible materials such as gasoline or fine wood shavings or use in areas where they may be present.
- Store your vacuum cleaner indoors in a cool, dry area.
- Avoid picking up hard, sharp objects with the cleaner, they may damage the cleaner.
- Always turn off this appliance before connecting or disconnecting the hose, removing the bottom plate for maintenance.
- Use only on dry, indoor surfaces, never change the plug in any way.
- Do not modify the polarized plug to fit a non-polarized outlet or extension cord.
- Do not touch the brush roller when it is rotating.
- Keep suction away from your face when using nozzles and pipe.
- Do not pull the power cord around sharp corners and do not allow it to become trapped.
- Unplug before connecting turbine nozzle.(only using turbine-brush model)

SAVE THESE INSTRUCTIONS FOR FUTURE USE.

Assembling Parts

Identifications of parts

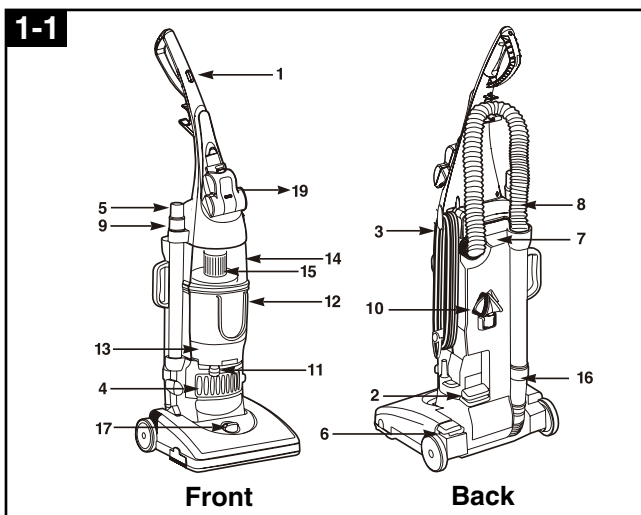

The assembled cleaner will look like the illustration to the left.

1. Handle
2. Power switch
3. Quick release cord hook
4. Post-Motor Filter
5. Crevice tool
6. Handle release
7. Carrying handle
8. Hose
9. Extension wand
10. Combination lock
11. Cyclone-Lever
12. Dirt Cup
13. Filter Cup
14. Upper Tank
15. Louvers
16. Hose Wand Base
17. Height Adjustment Dial
18. Hose Clip
19. Mini Turbo Brush

WARNING!

OPERATE THE VACUUM CLEANER ONLY AT THE VOLTAGE SPECIFIED ON THE NAMEPLATE.

Step 1. Attaching the Handle

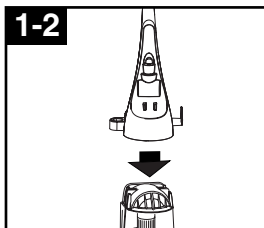

Stand the vacuum upright and slide the base of the handle firmly into the grooves at the top of the vacuum body.

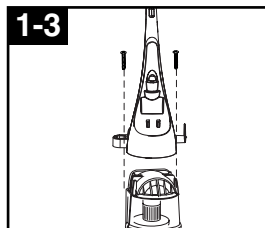

Insert the screw provided into the existing hole. Tighten the screw securely with a screwdriver. Before securing the handle, please check that the handle is fitted to the vacuum body and make sure there's no gap.

Step 2. Attaching the Hose and Tools

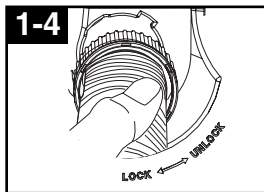

Line up the tabs on the base of the Twist Snap Hose with the corresponding notches on the hose collar as shown.

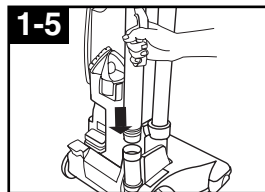

Slide the end of the hose wand with tabs into the Hose Wand Base.

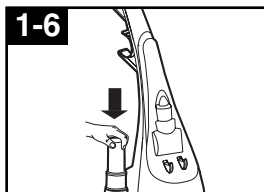

Slide the extension wand and the crevice tool together into the storage clip.

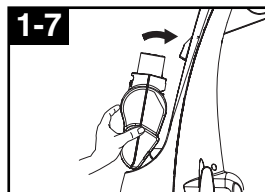

Attach the Mini Turbo Brush by putting the rib at the bottom of Mini Turbo Brush on two hooks of Handle. Snap Mini Turbo Brush into place as shown.

Operation

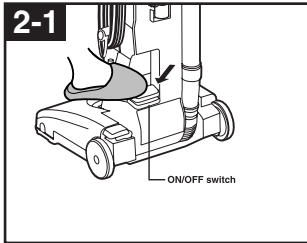

ON-OFF Switch

1. To turn cleaner on, press the Power switch.
2. To the cleaner off, press the Power switch again.

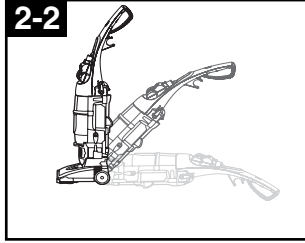

Handle positions

The handle of your cleaner has three positions; **upright** for storage and when using cleaning tools; **operating** for general operation on carpet and floors; **low** for reaching under low furniture. Step on handle release pedal to lower handle.

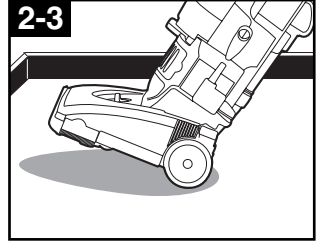

Transporting cleaner

To move your cleaner from room to room, put the handle in upright position, tilt the cleaner back on its rear wheels and push forward.

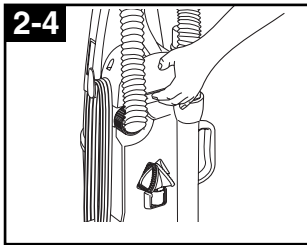

Carrying handle

The cleaner can also be moved by using the carrying handle.

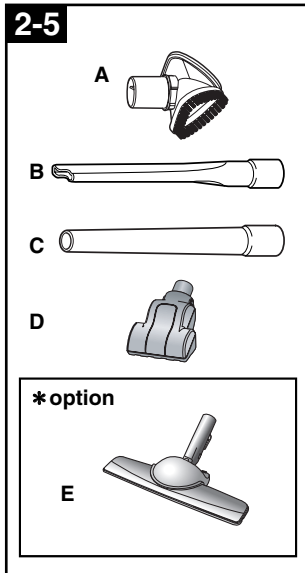

Cleaning Tool attachments

Attachment tools can be used to clean furniture or drapes, on stairs or in corners.

When using the attachments, ensure the vacuum cleaner is placed firmly on the floor with the handle in the upright position. Do not place the vacuum on top of furniture or steps as the brushroller may cause damage.

A. Combination tool:

Two types of cleaning tools are included in one attachment: rotate for desired tool.

- Use brush side to dust furniture, blinds, books, lamps, shelves.
- Use upholstery side for curtains, draperies, cushions, fabrics.

B. Crevice tool:

Use in corners, on stairs, baseboards, and behind furniture.

C. Extension Wand:

Use with desired attachments and narrow wand for a longer reach.

D. Mini Turbo Brush :

Use rotating brush action for small areas such as stairs and upholstery.

Note: Press gently when using Mini Turbo Brush to gain maximum cleaning. Too much pressure could cause the brush to stop rotating.

* option

E. Wooden Floor Brush (Select Models):

Use for bare floors. Swivel head turns to get into tight spaces and fits under cabinets.

Note: The Wooden Floor Brush does not store on board.

Operation

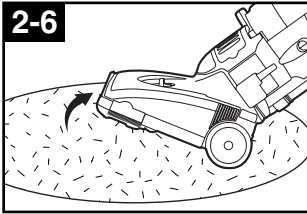

Cleaning lightweight flexible rugs

Stand on one end of rug and move cleaner toward other end or edge. Before reaching edge, push down on handle. This will lift up the nozzle (front of cleaner) and will prevent rug from clinging to cleaner.

Continue to lift front of cleaner so that when you have reached the edge, it is completely off the rug. Move cleaner back to start again, lower front of cleaner, and use only forward strokes.

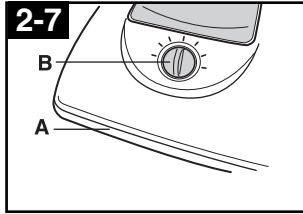

Carpet height adjustment

Carpet and rug cleaning takes place at the nozzle (A).

When it is necessary to raise and lower the nozzle for various carpet pile heights, rotate the nozzle control dial (B) to the desired setting.

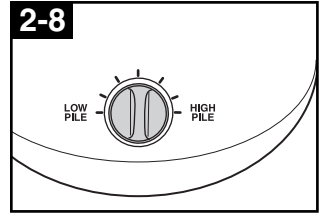

For maximum cleaning performance, The following carpet height settings are recommended:

- Lowest setting: for bare floors
- Medium setting : for short and medium pile carpets
- Higher settings: for very deep pile carpet where easier pushing effort is desired, while maintaining good cleaning performance.

Note: If the cleaner is difficult to push, rotate knob to the next higher setting.

Maintenance

Familiarize yourself with these home maintenance tasks as proper use and care of your cleaner will ensure continued cleaning effectiveness.

When to empty the Dirt Cup

The dirt cup needs to be emptied when the dirt reaches the "Full" line on the side of the Cup. If more dirt than this accumulates, your cleaner will not operate effectively.

Note: All new carpet has loose fibers which can fill the Dirt Cup quickly while vacuuming.

Emptying the Dirt Cup

Disconnect cleaner from electrical outlet.

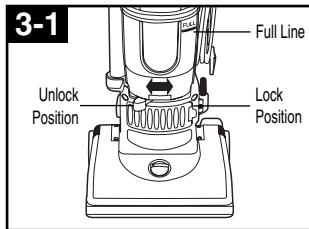

Slide the Cyclone-Lever to the "Unlock" position. Grasp handle and pull the Dirt Cup straight out to remove from Vacuum.

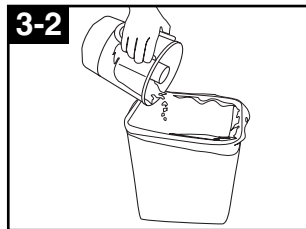

Empty dirt into garbage container. Put the Dirt Cup back in the vacuum and slide the lever to the "Lock" position.

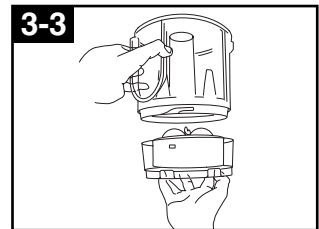

Cleaning The Circular Filters.

Grasp the Filter Cup located at the bottom of the Dirt Cup and twist counterclockwise to unlock and remove.

Cleaning the Pre/Post-motor Filter

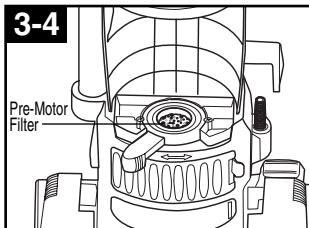

How to clean Disconnect cleaner from electrical outlet.

The Pre-Motor Filter protects the Motor from debris.

It is located underneath the Dirt Cup and Filter Cup in the Center of the round part of the Cyclone-Lever.

Remove the small round Filter and any debris on top of it.

Rinse

well under warm water, then air dry thoroughly before replacing.

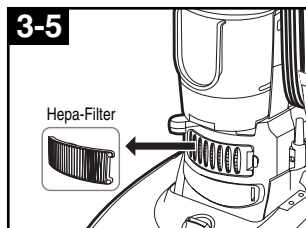

The Post-Motor Filter assists in the filtration process to return clean air to the room. It is located behind the door on the front of the Cleaner.

When the filter becomes dirty,

The Hepa-Filter :

Open the door, remove the filter and replace.

The Hepa-Filter is not washable and must be replaced.

Replace the door by inserting the tabs on the left side and snapping the right side into place.

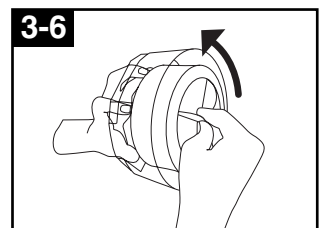

Grasp the Circular Filters and twist to unlock.

Pull straight up to remove.

Separate the Outer foam and Inner pleated Circular Filters.

Wash each individually by hand in warm water. Mild detergent may be used if desired.

Rinse well, then air dry

Thoroughly dry before putting

them back together and

replacing in the Filter Cup The

Filter Cup may be washed In

warm water with a mild

detergent. Make sure it is

completely dry before

reassembling with filters.

Do not operate cleaner without Either the Pre-Motor Filter or

Post-Motor Filter in place.

Maintenance

The belt

The belt on your cleaner causes the agitator to rotate and is important for the effective operation of the cleaner. The belt is located under the bottom plate of the cleaner and should be checked from time to time to be sure it is in good condition.

When to replace

Disconnect cleaner from electrical outlet.

To check belt, remove bottom plate as shown in "How to replace." Replace belt if it is stretched, cut or broken.

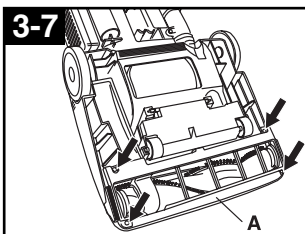

How to replace

Disconnect cleaner from electrical outlet.

Place handle in low position and turn cleaner over so bottom side is up. Remove the 4 screws as shown with a screw driver.

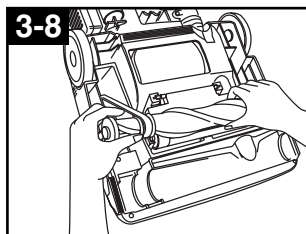

Remove agitator and used belt. Discard used belt.

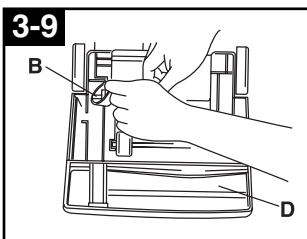

With lettering on outside of belt and positioned as shown in box (D), slide new belt over motor pulley (B).

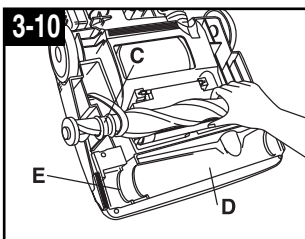

Insert agitator through belt and place belt in belt guide (C) on agitator.

Should the agitator shield (D) become dislodged while replacing the belt or the agitator, reposition it as shown, noting the placement of its belt guide (E)

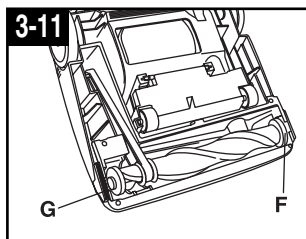

Grasp agitator firmly and fit it into position by first sliding the end opposite the belt into the rectangular slot (F) on side of cleaner. Pull other side of agitator (G) into place. Turn agitator, making sure belt is not pinched between agitator and agitator shield.

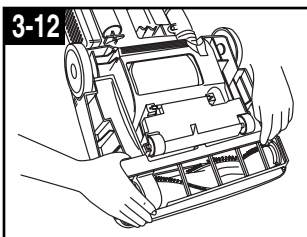

Reposition bottom plate and 4 screws. Tighten screws securely.

When to replace the agitator brush roll

When agitator brushes are worn, the agitator should be replaced. To check condition of brushes, **disconnect cleaner from electrical outlet.**

Move the edge of a card across bottom plate while turning agitator. To maintain cleaning effectiveness, replace agitator if brushes do not touch card.

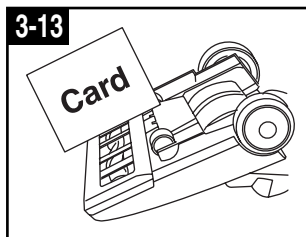

How to replace

Disconnect cleaner from electrical outlet.

Remove bottom plate, belt and agitator following directions in "The belt" section beginning with Fig. 3-10. Discard old agitator.

Continue following the directions in "The belt" section to reposition belt, new agitator and bottom plate.

Maintenance

Clearing Blockages

Disconnect cleaner from electrical outlet.

The hose on the back of the vacuum cleaner that carries the dirt from the nozzle to the Dirt Cup can sometimes become clogged. If you notice a change in the sound of the vacuum motor, check for blockages.

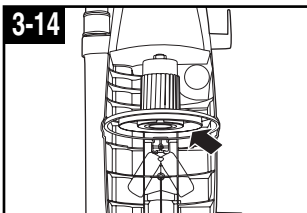

Remove Dirt Cup and check Upper Tank and Louvers. Check to make sure Louvers are Installed correctly. To unlock the Louvers, grasp the rim and turn Toward the left. Pull straight down to remove. If the Louvers are missing or not locked into place, check and clear the tube in the center of the Dirt Cup.

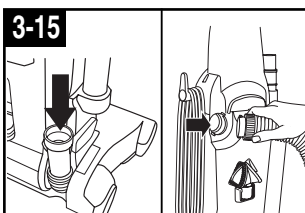

Remove the Hose and disconnect the Wand. Check for clogs in the vacuum base, the wand, the hose and the suction inlet.

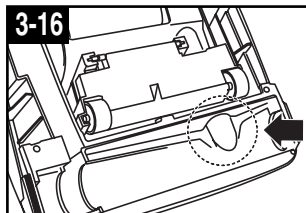

If the blockage persists, turn the vacuum cleaner off and unplug it. Remove the bottom plate. Lift up the short hose in the base of the vacuum. Inspect the hose for clogs and remove any obstructions. Replace the short nozzle hose and the bottom plate.

Mini Turbo Brush

Use for upholstered furniture, carpeted stairs and hard-to-reach places.

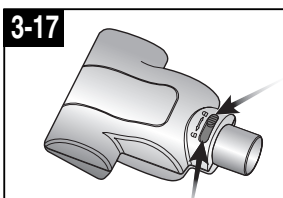

Brush bar Replacement

Remove the tool from the hose, and turn upside down. Slide the switch to unlock position.

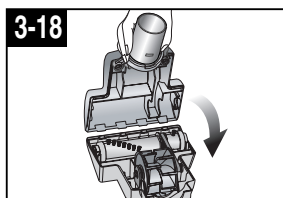

Remove bottom plate. And remove brushbar and discard. Inspect belt to ensure that it is in good condition. If broken or cracked, please replace. (See below for details.)

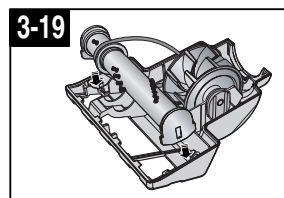

With the curved ends facing down, slide end plates of brushbar into slots on the tool. To replace bottom plate, insert the four tabs on edge of bottom plate into slots on front of tool. Pivot bottom plate down and snap closed.

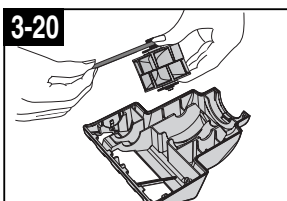

Belt Replacement

Grasp turbine and pull firmly to remove. Remove belt from turbine pulley. Replace with new belt.

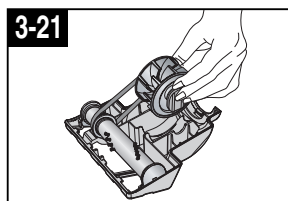

With flat sides of turbine retainers pointing down, slide retainers into grooves in tool housing and snap into place. Replace brushbar and bottom plate.

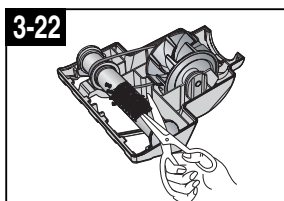

Cleaning Brushbar

- Cut off pet hairs or threads surrounding brush by using scissors.

Troubleshooting

Check this list of possible problems and solutions before bringing your vacuum to a service center.

Problem: Cleaner won't run

Possible Cause

Possible Solution

- **Not firmly plugged in**
- *Plug unit in firmly*
- **No voltage in wall plug**
- *Check fuse or breaker*
- **Blown fuse or tripped breaker**
- *Replace fuse or reset breaker*
- **Filters blocked or dirty**
- *Clean filters as per manual instructions*

Problem : Dust escapes the Dirt Cup

Possible Cause

Possible Solution

- **Dirt Cup improperly installed**
- *Re-install the Dirt Cup.*

Problem : Cleaner hard to push

Possible Cause

Possible Solution

- **Incorrect carpet height setting**
- *Rotate nozzle control knob to lower setting*

Problem : Poor job of dirt pickup

Possible Cause

Possible Solution

- **Full or clogged Dirt Cup**
- *Empty the Dirt Cup and check for blockages.*
- **Broken or worn belt**
- *Replace belt.*
- **Clogged hose or nozzle**
- *Clean hose or nozzle area.*
- **Hole in hose**
- *Replace hose.*
- **Dirt Cup improperly installed**
- *Properly install the Dirt Cup*
- **Incorrect carpet height setting**
- *Rotate nozzle control knob to lower setting*
- **Clogs in air flow passage**
- *Clear clogs/clean filters as per manual instructions*

Problem : Abnormal sound

Possible Cause

Possible Solution

- **Strange sound like rushing air**
- *Check for clogs in hose, nozzle area and or filters, clear or claen any clogs or blockages as per manual instructions*

If you have any comments or questions regarding a Samsung products, contact the SAMSUNG customer care center.

Country	Customer Care Center ☎	Web Site
AUSTRALIA	1300 362 603	www.samsung.com/au

MEMO

SAMSUNG

MEMO

SAMSUNG



DJ68-00294G REV(0.0)

Free Manuals Download Website

<http://myh66.com>

<http://usermanuals.us>

<http://www.somanuals.com>

<http://www.4manuals.cc>

<http://www.manual-lib.com>

<http://www.404manual.com>

<http://www.luxmanual.com>

<http://aubethermostatmanual.com>

Golf course search by state

<http://golfingnear.com>

Email search by domain

<http://emailbydomain.com>

Auto manuals search

<http://auto.somanuals.com>

TV manuals search

<http://tv.somanuals.com>