



WW10H9****
WW90H9****

Washing Machine

User manual

Imagine the possibilities

Thank you for purchasing this Samsung product.



Content

Safety information	3
What you need to know about the safety instructions	3
Important safety symbols	3
Important safety precautions	4
Instructions about the WEEE	10
Installation	11
What's included	11
Installation requirements	12
Step-by-step installation	14
Before you start	18
Initial settings	18
Laundry guidelines	20
Detergent Guidelines	22
Operations	25
Screen	25
Simple steps to start	28
Course overview	29
Settings	33
Samsung Smart Washer app	37
Samsung Smart Home app	39
Maintenance	41
Eco Drum Clean	41
Emergency drain	42
Cleaning	43
Recovery from freezing	46
Care against an extended time of disuse	46
Troubleshooting	47
Checkpoints	47
Information codes	48
Specifications	49
Protecting the environment	49
Declaration of conformity	49
Fabric care chart	50
Specification sheet (Only for EU models)	51
Information of main washing programmes	52
Specification sheet	53

Safety information

Congratulations on your new Samsung washing machine. This manual contains important information on the installation, use and care of your appliance. Please take some time to read this manual to take full advantage of your washing machine's many benefits and features.

What you need to know about the safety instructions



Please read this manual thoroughly to ensure that you know how to safely and efficiently operate the extensive features and functions of your new appliance. Please store the manual in a safe location close to the appliance for future reference. Use this appliance only for its intended purpose as described in this instruction manual.

Warnings and Important Safety Instructions in this manual do not cover all possible conditions and situations that may occur. It is your responsibility to use common sense, caution and care when installing, maintaining and operating your washing machine.

Because the following operating instructions cover various models, the characteristics of your washing machine may differ slightly from those described in this manual and not all warning signs may be applicable. If you have any questions or concerns, contact your nearest service centre or find help and information online at www.samsung.com.

Important safety symbols

What the icons and signs in this user manual mean:

	WARNING: Hazards or unsafe practices that may result in severe personal injury, death and/or property damage.
	CAUTION: Hazards or unsafe practices that may result in personal injury and/or property damage.
	NOTE

These warning signs are here to prevent injury to yourself and others.

Please follow them explicitly.

After reading this manual, store it in a safe place for future reference.

Read all instructions before using the appliance.

As with any equipment that uses electricity and moving parts, potential hazards exist. To safely operate this appliance, familiarize yourself with its operation and exercise care when using it.

Important safety precautions

 **WARNING:** To reduce the risk of fire, electric shock, or injury to persons when using your appliance, follow basic precautions, including the following:

Do not let children (or pets) play in or on your washing machine. The washing machine door does not open easily from the inside and children may be seriously injured if trapped inside.

This appliance is not to be used by persons (including children) with reduced physical, sensory or mental capabilities, or lack of experience and knowledge, unless they have been given supervision or instruction concerning use of the appliance by a person responsible for their safety.

Children should be supervised to ensure that they do not play with the appliance.

For use in Europe: This appliance can be used by children aged from 8 years and above and persons with reduced physical, sensory or mental capabilities or lack of experience and knowledge if they have been given supervision or instruction concerning use of the appliance in a safe way and understand the hazards involved. Children shall not play with the appliance. Cleaning and user maintenance shall not be made by children without supervision.

If the supply cord is damaged, it must be replaced by the manufacturer, its service agent or similarly qualified persons in order to avoid a hazard.

This appliance should be positioned so that the power plug, the water supply taps, and the drain pipes are accessible.

For appliances with ventilation openings in the base, that a carpet must not obstruct the openings.

The new hose-sets supplied with the appliance are to be used and that old hose-sets should not be reused.

CAUTION: In order to avoid a hazard due to inadvertent resetting of the thermal cut-out, this appliance must not be supplied through an external switching device, such as a timer, or connected to a circuit that is regularly switched on and off by the utility.

⚠ WARNING: Critical installation WARNINGS

The installation of this appliance must be performed by a qualified technician or service company.

- Failure to do so may result in electric shock, fire, an explosion, problems with the product, or injury.

The appliance is heavy, therefore take care when lifting it.

Plug the power cord into an AC 220 - 240 V / 50 Hz wall socket or higher and use the socket for this appliance only. Never use an extension cord.

- Sharing a wall socket with other appliances using a power strip or extending the power cord may result in electric shock or fire.
- Ensure that the power voltage, frequency, and current are the same as those of the product specifications. Failure to do so may result in electric shock or fire. Plug the power plug into the wall socket firmly.

Remove all foreign substances such as dust or water from the power plug terminals and contact points using a dry cloth on a regular basis.

- Unplug the power plug and clean it with a dry cloth.
- Failure to do so may result in electric shock or fire.

Plug the power plug into the wall socket so that the cord is running towards the floor.

- If you plug the power plug into the socket in the opposite direction, the electric wires within the cable may be damaged and this may result in electric shock or fire.

Keep all packaging materials out of the reach of children as these may be dangerous.

- If a child places a bag over its head, it may suffocate.

When the appliance, power plug or power cord is damaged, contact your nearest service centre.

This appliance must be properly grounded.

Do not ground the appliance to a gas pipe, plastic water pipe, or telephone line.

- This may result in electric shock, fire, an explosion, or problems with the product.
- Never plug the power cord into a socket that is not grounded correctly and make sure that it is in accordance with local and national regulations.

Do not install this appliance near a heater or any inflammable material.

Do not install this appliance in a humid, oily or dusty location, or in a location exposed to direct sunlight or water (rain drops).

Do not install this appliance in a location exposed to low temperatures.

- Frost may cause the tubes to burst.

Do not install this appliance in a location where gas may leak.

- This may result in electric shock or fire.

Do not use an electric transformer.

- This may result in electric shock or fire.

Do not use a damaged power plug, damaged power cord, or loose wall socket.

- This may result in electric shock or fire.

Do not pull or excessively bend the power cord.

Do not twist or tie the power cord.

Do not hook the power cord over a metal object, place a heavy object on the power cord, insert the power cord between objects, or push the power cord into the space behind the appliance.

- This may result in electric shock or fire.

Do not pull the power cord when unplugging the power plug.

- Unplug the power plug by holding the plug.
- Failure to do so may result in electric shock or fire.

CAUTION: Installation CAUTIONS

This appliance should be positioned in such a way that the power plug is easily accessible.

- Failure to do so may result in electric shock or fire due to electric leakage.

Install your appliance on a solid, level floor that can support its weight.

- Failure to do so may result in abnormal vibrations, movement, noise, or problems with the product.

WARNING: Critical usage WARNINGS

If the appliance is flooded, turn off the water & power supplies immediately and contact your nearest service centre.

- Do not touch the power plug with wet hands.
- Failure to do so may result in electric shock.

If the appliance generates a strange noise, a burning smell, or smoke, unplug the power plug immediately and contact your nearest service centre.

- Failure to do so may result in electric shock or fire.

In the event of a gas leak (such as propane gas, LP gas, etc.), ventilate immediately without touching the power plug. Do not touch the appliance or power cord.

- Do not use a ventilating fan.
- A spark may result in an explosion or fire.

Do not let children play in or on the washing machine. In addition, when disposing of the appliance, remove the washing machine door lever.

- If trapped inside the product, children may suffocate to death.

Make sure to remove the packaging (sponge, styrofoam) attached to the bottom of the washing machine before using it.

Do not wash items contaminated with gasoline, kerosene, benzene, paint thinner, alcohol or other inflammable or explosive substances.

- This may result in electric shock, fire, or an explosion.

Do not open the washing machine door by force while it is operating (high-temperature washing/drying/spinning).

- Water flowing out of the washing machine may result in burns or cause the floor to be slippery. This may result in injury.
- Opening the door by force may result in damage to the product or injury.

Do not insert your hand under the washing machine while an operation is in progress.

- This may result in injury.

Do not touch the power plug with wet hands.

- This may result in electric shock.

Do not turn the appliance off by unplugging the power plug while an operation is in progress.

- Plugging the power plug into the wall socket again may cause a spark and result in electric shock or fire.

Do not let children or the infirm use this washing machine without proper supervision. Do not let children climb in or onto the appliance.

- This may result in electric shock, burns or injury.

Do not insert your hand or a metal object under the washing machine while it is operating.

- This may result in injury.

Do not unplug the appliance by pulling the power cord. Always grip the plug firmly and pull it straight out of the outlet.

- Damage to the power cord may cause a short-circuit, fire and/or electric shock.

Do not attempt to repair, disassemble, or modify the appliance yourself.

- Do not use a fuse (such as copper, steel wire, etc.) other than a standard fuse.
- When the appliance needs to be repaired or reinstalled, contact your nearest service centre.
- Failure to do so may result in electric shock, fire, problems with the product, or injury.

If the water supply hose comes loose from the water tap and floods the appliance, unplug the power plug.

- Failure to do so may result in electric shock or fire.

Unplug the power plug when the appliance is not being used for long periods of time or during a thunder or lightning storm.

- Failure to do so may result in electric shock or fire.

If any foreign substance enters into the appliance, unplug the power plug and contact your nearest Samsung Customer Service.

- This may result in electric shock or fire.

CAUTION: Usage CAUTIONS

When the washing machine is contaminated by a foreign substance such as detergent, dirt, food waste, etc., unplug the power plug and clean the washing machine using a damp, soft cloth.

- Failure to do so may result in discolouration, deformation, damage, or rust.

The front glass may be broken by a strong impact. Take care when using the washing machine.

- If the glass is broken, it may result in injury.

After a water supply failure or when reconnecting the water supply hose, open the water tap slowly.

Open the water tap slowly after a long period of non-use.

- The air pressure in the water supply hose or the water pipe may damage a product part or result in a water leak.

If a draining error occurs during an operation, check if there is a draining problem.

- If the washing machine is used when it is flooded because of a draining problem, it may result in electric shock or fire.

Insert the laundry into the washing machine completely so that the laundry does not get caught in the door.

- If laundry gets caught in the door, it may result in damage to the laundry or the washing machine, or result in a water leak.

Turn the water supply off when the washing machine is not being used.

Ensure that the screws on the water supply hose connector are properly tightened.

- Failure to do so may result in property damage or injury.

Ensure that the rubber seal and front door glass are not contaminated by a foreign substance (e.g. waste, thread, hair, etc.).

- If a foreign substance is caught in the door or the door is not completely closed, it may cause a water leak.

Open the water tap and check if the water supply hose connector is firmly tightened and that there is no water leak before using the product.

- If the screws on the water supply hose connector are loose, it may result in a water leak.

The product you have purchased is designed for domestic use only.

Using the product for business purposes qualifies as a product misuse. In this case, the product will not be covered by the standard warranty provided by Samsung and no responsibility can be attributed to Samsung for malfunctions or damages resulting from such misuse.

Do not stand on the appliance or place objects (such as laundry, lighted candles, lighted cigarettes, dishes, chemicals, metal objects, etc.) on the appliance.

- This may result in electric shock, fire, problems with the product, or injury.

Do not spray volatile material such as insecticide onto the surface of the appliance.

- As well as being harmful to humans, this may result in electric shock, fire or problems with the product.

Do not place objects that generate electromagnetic fields near the washing machine.

- This may result in injury due to a malfunction.

Water drained during a high-temperature wash or drying cycle is hot. Do not touch the water.

- This may result in burns or injury.

Do not wash, spin, or dry water-proof seats, mats, or clothing (*) unless your appliance has a special cycle for washing these items.

(*): Woollen bedding, rain covers, fishing vests, ski pants, sleeping bags, diaper covers, sweat suits, and bicycle, motor cycle and car covers, etc.

- Do not wash thick or hard mats even if the washing machine mark is on the care label. This may result in injury or damage to the washing machine, walls, floor, or clothing due to abnormal vibrations.
- Do not wash throw rugs or doormats with rubber backing. The rubber backing may come off and stick to inside the drum, and this may result in malfunction such as a drainage error.

Do not operate the washing machine when the detergent drawer is removed.

- This may result in electric shock or injury due to a water leak.

Do not touch the insides of the drum during or just after drying as it is hot.

- This may result in burns.

Do not insert your hand into the detergent drawer.

- This may result in injury as your hand may be caught by the detergent input device.

Do not place any objects (such as shoes, food waste, animals) other than laundry into the washing machine.

- This may result in damage to the washing machine, or injury and death in the case of pets due to the abnormal vibrations.

Do not press the buttons using sharp objects such as pins, knives, fingernails, etc.

- This may result in electric shock or injury.

Do not wash laundry contaminated by oils, creams or lotions usually found in skincare shops or massage clinics.

- This may cause the rubber seal to become deformed and result in a water leak.

Do not leave metal objects such as safety pins, hair pins or bleach in the drum for long periods of time.

- This may cause the drum to rust.
- If rust starts appearing on the surface of the drum, apply a (neutral) cleansing agent to the surface and use a sponge to clean it. Never use a metal brush.

Do not use dry cleaning detergent directly and do not wash, rinse, or spin laundry contaminated by dry cleaning detergent.

- This may result in spontaneous combustion or ignition due to the heat from the oxidation of the oil.

Do not use water from water cooling/heating devices.

- This may result in problems with the washing machine.

Do not use natural hand-washing soap for the washing machine.

- If it hardens and accumulates inside the washing machine, it may result in problems with the product, discolouration, rust, or bad odours.

Place socks and brassieres in a washing net and wash them with the other laundry.

Do not wash large laundry items such as bedding in the washing net.

- Failure to do so may result in injury due to abnormal vibrations.

Do not use hardened detergent.

- If it accumulates inside the washing machine, it may result in a water leak.

Make sure that the pockets of all the clothing items to be washed are empty.

- Hard, sharp objects such as coins, safety pins, nails, screws, or stones can cause extensive damage to the appliance.

Do not wash clothing with large buckles, buttons or other heavy metal objects.

Sort the laundry by color on the basis of its colorfastness and select the recommended cycle, water temperature and additional functions.

- This may result in discoloration or fabric damage.

Take care that children's fingers are not caught in the door when you close it.

- Failure to do so may result in injury.

⚠ WARNING: Critical cleaning WARNINGS

Do not clean the appliance by spraying water directly onto it.

Do not use the a strong acidic cleaning agent.

Do not use benzene, thinner or alcohol to clean the appliance.

- This may result in discolouration, deformation, damage, electric shock or fire.

Before cleaning or performing maintenance, unplug the appliance from the wall socket.

- Failure to do so may result in electric shock or fire.

Instructions about the WEEE



Correct Disposal of This Product (Waste Electrical & Electronic Equipment) (Applicable in countries with separate collection systems)

This marking on the product, accessories or literature indicates that the product and its electronic accessories (e.g. charger, headset, USB cable) should not be disposed of with other household waste at the end of their working life. To prevent possible harm to the environment or human health from uncontrolled waste disposal, please separate these items from other types of waste and recycle them responsibly to promote the sustainable reuse of material resources.

Household users should contact either the retailer where they purchased this product, or their local government office, for details of where and how they can take these items for environmentally safe recycling.

Business users should contact their supplier and check the terms and conditions of the purchase contract. This product and its electronic accessories should not be mixed with other commercial wastes for disposal.

Installation

Follow these instructions carefully to ensure proper installation of the washing machine and to prevent accidents when doing laundry.

What's included

Make sure all the parts are included in the product package. If you have a problem with the washing machine or the parts, contact a local Samsung customer centre or the retailer.

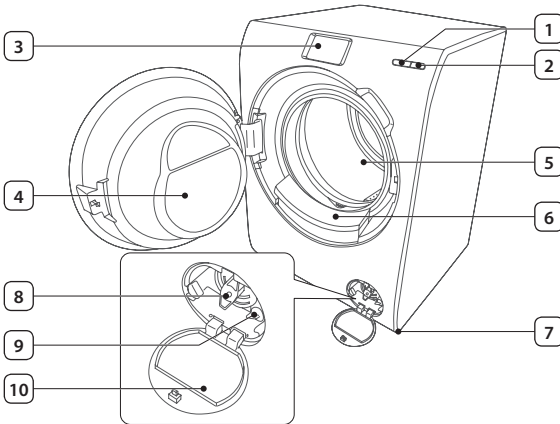

1	Start button
2	Power button
3	Control screen
4	Door
5	Drum
6	Auto Dispense unit
7	Levelling feet
8	Debris filter
9	Emergency drain tube
10	Filter cover



Spanner



Bolt caps

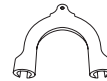

Hose guide



Cold water supply hose



Hot water supply hose

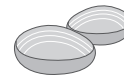

Aqua pebble set



Bolt caps : The provided number (3 to 6) of bolt caps depends on the model.

Hot water supply hose: Applicable models only.

Aqua pebble set: 200 ml and 100 ml (MAX).

Installation requirements

Electrical supply and grounding

- AC 220-240 V / 50 Hz fuse or circuit breaker is required
- Use an individual branch circuit specific to the washing machine

To ensure proper grounding, the washing machine comes with a power cord featuring a three-prong grounding plug for use in a properly installed and grounded outlet.

Check with a qualified electrician or serviceperson if you are not sure about the grounding.

Do not modify the provided plug. If it does not fit the outlet, call a qualified electrician to install a proper outlet.



WARNING

- Do NOT use an extension cord.
- Use only the power cord that comes with the washing machine.
- Do NOT connect the ground wire to plastic plumbing, gas lines, or hot water pipes.
- Improperly connected grounding conductors may cause electric shock.

Water supply

A proper water pressure for this washing machine is between 50 kPa and 800 kPa. Water pressure less than 50 kPa may cause the water valve not to close completely. Or, it may take longer to fill the drum, causing the washing machine to turn off. Water taps must be within 120 cm from the rear of the washing machine so that the provided inlet hoses reach the washing machine.

To reduce the risk of leaks

- Make sure water taps are easily accessible.
- Turn off the taps when the washing machine is not in use.
- Check for any leaks at the water inlet hose fittings on a regular basis.



CAUTION

Before using the washing machine for the first time, check all connections at the water valve and taps for any leaks.

Drain

Samsung recommends a standpipe in height of 65 cm. The drain hose must be connected through the hose clip to the standpipe, and the standpipe must fully cover the drain hose.

Flooring

For best performance, the washing machine must be installed on a solid floor. Wood floors may need to be reinforced to minimize vibration and/or unbalanced loads. Carpeting and soft tile surfaces are not a good resistance to vibrations and may cause the washing machine to move slightly during the spin cycle.



CAUTION

Do NOT install the washing machine on a platform or a poorly supported structure.

Water temperature

Do not install the washing machine in areas where water may freeze as the washing machine always retains some water in its water valves, pumps, and/or hoses. Frozen water left in the connection parts may cause damage to belts, the pump, and other components of the washing machine.

Alcove or closet installation

Minimum clearance for stable operation:

Sides	25 mm	Rear	50 mm
Top	25 mm	Front	550 mm

If both the washing machine and a dryer are installed in the same location, the front of the alcove or closet must have at least a 550 mm unobstructed air opening. Your washing machine alone does not require a specific air opening.

Step-by-step installation

STEP 1 - Select a location

Location requirements:

- Solid, level surface without carpeting or flooring that may obstruct ventilation
- Away from direct sunlight
- Adequate room for ventilation and wiring
- The ambient temperature is always higher than the freezing point (0 °C)
- Away from a heat source

STEP 2 – Remove the shipping bolts

Unpack the product package and remove all shipping bolts.

1. Loosen all shipping bolts on the rear of the machine using the supplied spanner.

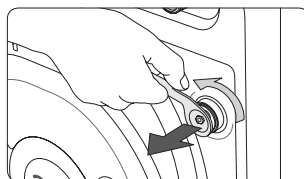

2. Fill the holes with the supplied plastic bolt caps. Keep the shipping bolts for future use.

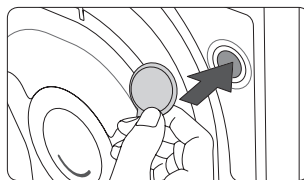

WARNING

Packaging materials can be dangerous to children. Dispose all packaging material (plastic bags, polystyrene, etc.) out of children's reach.

STEP 3 - Adjust the levelling feet

1. Gently slide the washing machine into position. Excessive force may damage the levelling feet.
2. Level the washing machine by manually adjusting the levelling feet.

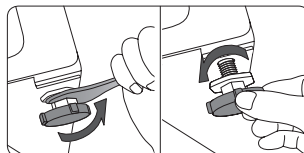

3. When levelling is complete, tighten the nuts using the spanner.

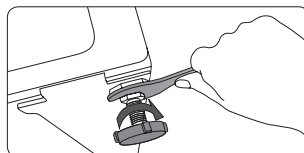

STEP 4 - Connect the water hose

Connect the water supply hose to the water tap.

1. Remove the **adaptor (A)** from the **water supply hose (B)**.

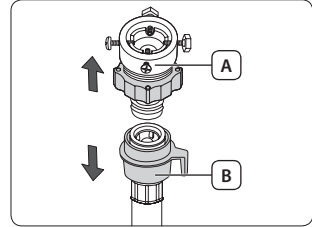

2. Use a Philips screwdriver to loosen four screws on the adaptor.

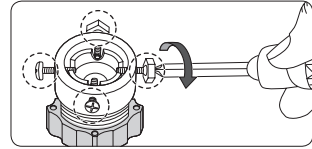

3. Hold the adaptor and turn **part (C)** in the arrow direction to loosen it by 5 mm (*).

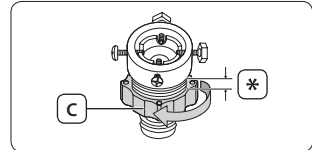

4. Insert the adaptor into the water tap, and tighten the screws while lifting up the adaptor.

5. Turn **part (C)** in the arrow direction to tighten it.

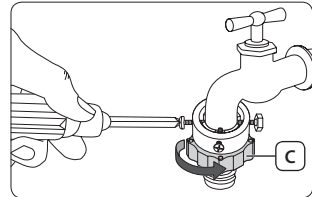

6. While holding down **part (E)**, connect the water supply hose to the adaptor. Then, release **part (E)**. The hose fits into the adaptor with a clicking sound.

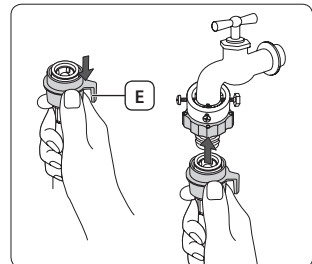

7. Connect the other end of the water supply hose to the inlet valve on the back of the washing machine. Turn the hose clockwise to tighten.

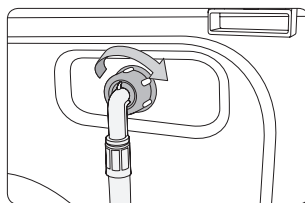

8. Open the water tap and check if there are any leaks around the connection areas. If there are water leaks, repeat the steps above.

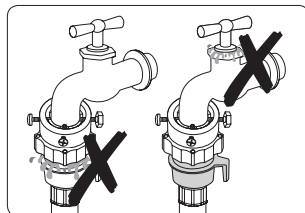

- If using a screw type of water tap, connect the water hose to the water tap as shown.

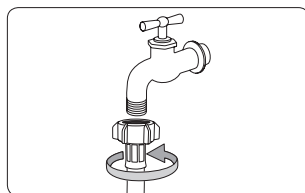

⚠ WARNING

Stop using the washing machine if there is a water leak, and contact a local Samsung service centre. Otherwise, this may cause electric shock.

⚠ CAUTION

Do not stretch the water supply hose by force. If the hose is too short, replace the hose with a longer, high-pressure hose.



- After connecting the water supply hose to the adaptor, check if it is connected properly by pulling the water supply hose downwards.
- Use a popular type of water taps. If the tap is square-shaped or too big, remove the spacer ring before inserting the tap into the adaptor.

For models with an additional hot water inlet:

1. Connect the red end of the hot water supply hose to the hot water inlet on the back of the machine.
2. Connect the other end of the hot water supply hose to the hot water tap.

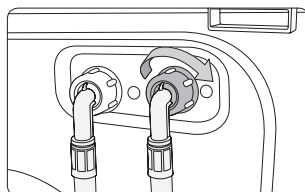

Aqua hose (applicable models only)

The aqua hose alerts users of a risk of water leaks. It senses the water flow and turns red on the centre **indicator (A)** in case of a leak.

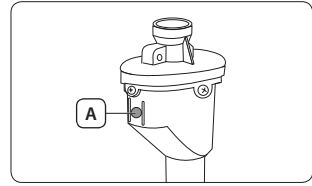

STEP 5 - Position the drain hose

The drain hose can be positioned in three ways:

Over the edge of a wash basin

The drain hose must be placed at a height of between 60 cm and 90 cm (*) from the floor. To keep the spout of the drain hose bent, use the supplied **plastic hose guide (A)**. Secure the guide to the wall using a hook to ensure stable drainage.

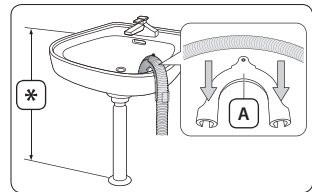

In a sink drain pipe

The drain pipe must be above the sink siphon so that the end of the hose is at least 60 cm above the floor.

In a drain pipe

The drain pipe should be between 60 cm and 90 cm high (*). It is advisable to use a 65 cm high vertical pipe. Make sure the drain hose is connected to the stand pipe at a slant.

Drain standpipe requirements:

- Minimum diameter of 5 cm
- Minimum carry-away capacity of 60 litres per minute

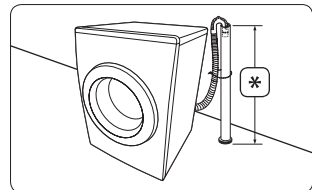

STEP 6 – Turn on the washing machine

Plug the power cord into a wall socket featuring an AC 220-240 V / 50 Hz approved electrical outlet protected by a fuse or circuit breaker. Then, press the **Power** button to turn on the washing machine.

Before you start

Initial settings

When the washing machine turns on for the first time, the welcome screen appears with the Samsung logo. Follow the onscreen instructions to complete the initial settings. You can change the initial settings later by accessing the Settings screen.

STEP 1 - Set Language

Set a preferred menu language.

1. Select a language.
2. Tap **Next**.

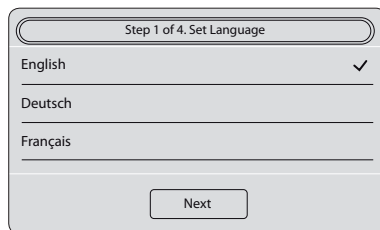

STEP 2 - Set Date & Time

Set the current date and time.

1. Tap the arrows to set the time for each time element.
2. Tap **Next**.

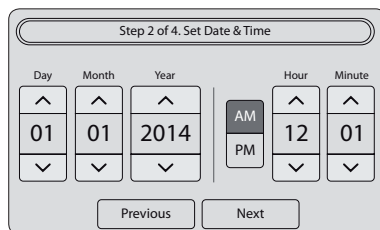

The default time is set to the 12-hour format.

To switch between the **AM** and **PM** elements, simply tap the corresponding element.

STEP 3 - Set Auto Dispense

The Auto Dispense unit dispenses an appropriate amount of detergent and fabric softener into the drum according to the course and cycle.

1. Both **Auto Detergent** and **Auto Softener** are set to **On** by default. To change the setting, slide the corresponding bar to **Off**.
2. Set the **Amount** and the **Water Hardness**.
3. Set the **Amount** and the **Concentration**.
4. Tap **Next**.

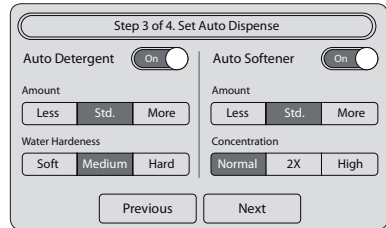

STEP 4 - Set Auto Update

Auto Update updates the firmware automatically for improved performance and/or to fix known bugs through communication with the update server. Once the firmware is updated, some functions of the washing machine may not be available depending on the firmware version.

1. To update the firmware automatically, set **Auto Update** to **On**.
2. Tap **Done**.

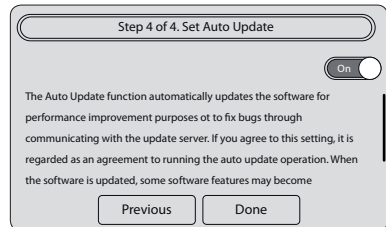

STEP 5 - Run Calibration (recommended)

Calibration ensures accurate weight detection by the washing machine. Make sure the drum is empty before running Calibration.

1. Tap **Settings > Calibration > Start**.
 - The door will be locked during the operation.
 - The drum keeps rotating clockwise and anticlockwise for several minutes.
2. When complete, the washing machine turns off automatically.

Laundry guidelines

STEP 1 - Sort

Sort the laundry according to these criteria:

- **Care Label:** Sort the laundry into cottons, mixed fibres, synthetics, silks, wools, and rayon.
- **Colour:** Separate whites from colours.
- **Size:** Mixing different-sized items together in the drum improves the washing performance.
- **Sensitivity:** Wash delicate items separately using an Easy Iron option for pure, new woollen items, curtains, and silk items. Check the labels on the items.



Make sure to check the care label on the clothing, and sort them accordingly before starting the wash.

STEP 2 - Empty pockets

Empty all the pockets of your laundry items

- Metal objects such as coins, pins, and buckles on clothing may damage other laundry items as well as the drum.

Turn clothing with buttons and embroideries inside out

- If pants or jacket zippers are open while washing, the drum may be damaged. Zippers should be closed and fixed with a string.
- Clothing with long strings may become entangled with other clothes. Make sure to tie the strings before starting the wash.

STEP 3 - Use a laundry net

- Brassieres (water washable) must be placed in a laundry net. Metal parts of the brassieres may break through and tear other laundry items.
- Small, light clothing such as socks, gloves, stockings, and handkerchiefs may become caught around the door. Place them inside a fine laundry net.
- Do not wash the laundry net by itself without other laundry. This may cause abnormal vibrations that could move the washing machine and result in injury.

STEP 4- Prewash (if necessary)

Select the Prewash option for the selected course if the laundry is heavily soiled. Do not use the Prewash option when detergent is manually added into the drum.

STEP 5- Determine the load capacity

Do not overload the washing machine. Overloading may cause the washing machine to not wash properly. For the load capacity for the type of clothing, see page **29**.



When washing bedding or bedding covers, the wash time may be lengthened or the spin efficiency may be reduced. For bedding or bedding covers, the recommended maximum spin cycle speed is 800 rpm, and the load capacity is 2.0 kg or less.



CAUTION

If the laundry is unbalanced and the “**UE**” error code is displayed, redistribute the load. Unbalanced laundry may reduce the spinning performance.

STEP 6- Apply a proper detergent type

The type of detergent depends on the type of fabric (cotton, synthetic, delicate items, wool), colour, wash temperature, and degree of soiling. Always use “low suds” laundry detergent, which is designed for automatic washing machines.



- Follow the detergent manufacturer’s recommendations based on the weight of the laundry, the degree of soiling, and the hardness of the water in your local area. If you are not sure about the water hardness, contact a local water authority.
- Do not use detergent that tends to be hardened or solidified. This detergent may remain after the rinse cycle, blocking the drain outlet.



CAUTION

When washing wool using the wool course, use only a neutral liquid detergent. If used with the Wool course, powder detergent may remain on the laundry and discolour the laundry.

Detergent Guidelines

Auto Dispense

The washing machine provides a two-compartment dispenser: the left compartment for detergent, and the right compartment for fabric softener. The Auto Dispense unit dispenses an appropriate amount of detergent and fabric softener into the drum according to the course and cycle.



CAUTION

- Use only a liquid detergent and fabric softener with the Auto Dispense unit.
- Make sure the Auto Dispense unit is inserted completely. The washing machine will not start operating until the Auto Dispense unit is inserted properly.
- When changing to a different detergent, make sure to clean the detergent compartment first.
- Do not mix detergent with fabric softener in either compartment.
- To prevent detergent from hardening, do not open the cap once the detergent has been applied to the compartment.
- Do not use any bleach that may cause corrosion and/or generate gas.
- Do not turn the Auto Dispense unit upside down. The content may spill out of the vents.
- Do not press the outlet at the bottom of the Auto Dispense unit while moving the unit. The content may leak.
- Use caution when inputting detergent or fabric softener in the unit. The content may spill around.
- Make sure to remove the Auto Dispense unit before applying detergents.
- When removing the Auto Dispense unit to check the remaining amount of detergent upon or before an error message, the unit may have some small amount of detergent remaining or leaking from the bottom of the unit.
- Fully insert the Auto Dispense unit. Incomplete insertion may cause the unit to fail in dispensing.
- By default, Auto Dispense turns off in the Delicates, Wool, Baby Care, or Outdoor Care courses.

To enable Auto Dispense in these courses, tap **Settings** or the **Quick Panel Bar > Auto Dispense**, and change the settings as necessary.

1. Open the door, and pull out the Auto Dispense unit from the washing machine.

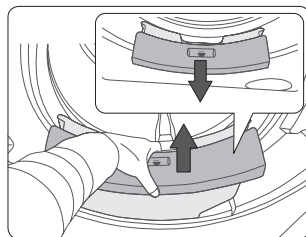

2. Turn the left knob anticlockwise to open, and apply detergent to the left compartment to the max line.
3. Turn the right knob anticlockwise to open, and apply fabric softener to the right compartment to the max line.
4. Lock the knobs by turning them clockwise.

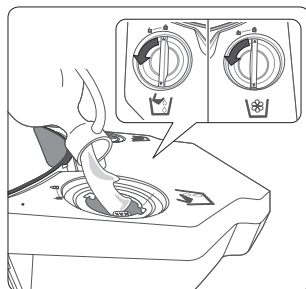

5. Reinsert the Auto Dispense unit in the original position. Use caution when inserting the unit as the content may spill out of the vents on either side.
6. Turn on **Auto Detergent** and **Auto Softener** if you have not done so already.

See “Auto Dispense” on page 33.

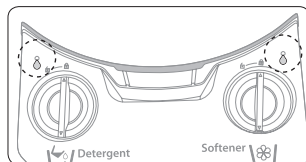

Manual Dispense

In case you don't want to use the dispenser (Auto Dispense unit), you can either dose the detergent directly into the drum or use the provided aqua pebble when applying detergent manually. The Aqua Pebbles comes in two sizes and are provided as accessories with your appliance. Choose an Aqua Pebble that is appropriate for the detergent amount.

1. Turn off Auto Detergent.

See “Auto Dispense” on page 33.

- 2. Apply a powder, gel, or liquid detergent to a proper Aqua pebble (A).** Check the amount marker on the inner side of the aqua pebble.

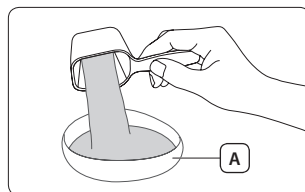

- 3. Insert the aqua pebble near the end of the drum.**

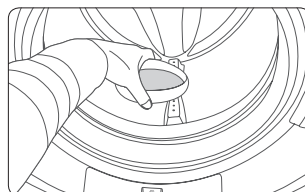

 When the wash is complete, remove the aqua pebble from the drum and keep it clean for later use.

 **CAUTION**

- Fabric softener can be applied only using the Auto Dispense unit. Manual input is not allowed.
- Use caution when inserting the aqua pebble as it is supposed to be balanced at the beginning of the wash. Tipping the aqua pebble before the start of a wash may cause detergent residue on the laundry at the end of the wash, causing discolouration to laundry and/or reduced washing performance.
- Do not apply detergent to both the auto detergent compartment and the aqua pebble.
- When applying a different detergent, make sure to clean the aqua pebble first.
- Do not insert the aqua pebble into a folded blanket or between different laundry items.
- Do not select the Pre Wash option when using the aqua pebble.
- A heavy application of detergent may cause the following problems, resulting in a system failure and/or shortened product life.
- Excessive amounts of detergent cause bubble surpluses and extend the rinse time as a result.
- This may also cause detergent remaining in the drum after the wash is complete.
- Apply appropriate amounts of detergent according to the specifications of the detergent manufacturer.
- In case of manual detergent dosage, it is recommended to use the Aqua Pebble when coloured laundry items are washed.

Operations

Screen

The actual screen may differ from the image below depending on the model.

Main screen

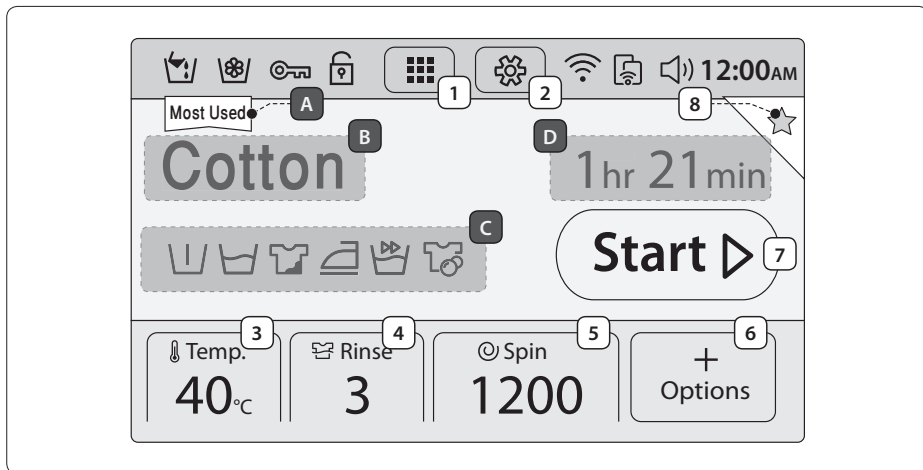

Buttons

1	Course	Tap to enter the course tile.
2	Settings	Tap to enter the settings screen.
3	Temp.	Tap to change the temperature for the current course.
4	Rinse	Tap to change the rinse times for the current course.
5	Spin	Tap to change the spinning speed for the current course.
6	Options	Tap to enter the course options screen.
7	Start	Tap to start an operation.
8	Favourite	Tap to add the current course configuration to the Favourite list. You can add up to 4 custom courses, which will then appear as favourite cycles at the beginning of the course selections.

Information

A	Most Used	Displays the most frequently used course.
B	Current course	Displays the current course.
C	Active option	Displays an active option(s) for the current course.
D	Estimated time	Displays the estimated operation time for the current course.

Status bar



	Auto Detergent	If this indicator turns on, Auto Detergent is enabled.
	Auto Softener	If this indicator turns on, Auto Softener is enabled.
	Door Lock	If this indicator turns on, the door is locked to prevent a door opening during operation.
	Child Lock	If this icon turns to a closed lock [], the Child Lock is set to prevent accidents by children or infants.
	Network	This displays the Wi-Fi network connection state.
	Smart Control	If this indicator turns on, the washing machine can be controlled on a mobile device.
	Sound	If the icon turns to Mute [], no sound is output.
12:00AM	Time	The current time is displayed.

Quick panel bar

On the **Quick panel bar**, 6 items are available: Child Lock, Drum Light, Auto Detergent, Auto Softener, Network, and Smart Control.

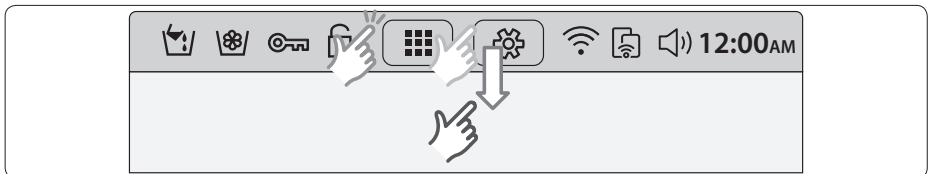

1. Tap the **Status bar**, or swipe it downward to display available items.

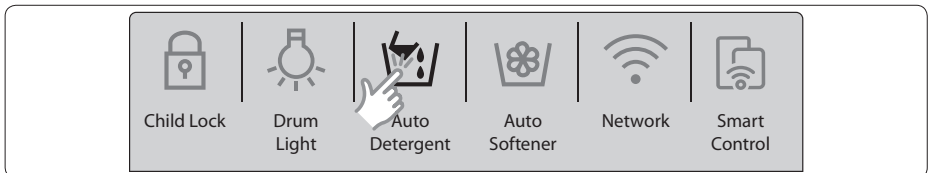

2. Tap to turn an item on/off, or change the current settings.



- For advanced settings, go to the settings screen, and make changes to your preferences.
- Active items are lit while inactive items are greyed out.

Options screen

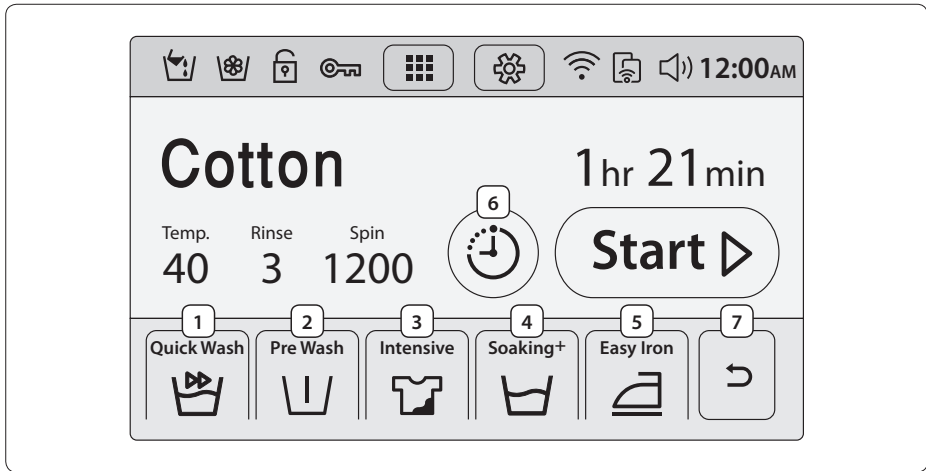



1	Quick Wash	Specific for less soiled clothing for a load less than 2 kg.
2	Pre Wash	A preliminary washing cycle is added before the main wash.
3	Intensive	The operation time for each cycle is longer than normal.
4	Soaking+	This is useful to remove stubborn stains on laundry.
5	Easy Iron	This is useful to reduce wrinkles.
6	Delay End	Use this to specify the end time of a selected course. See page 32.
7	Return	Return to the main screen.

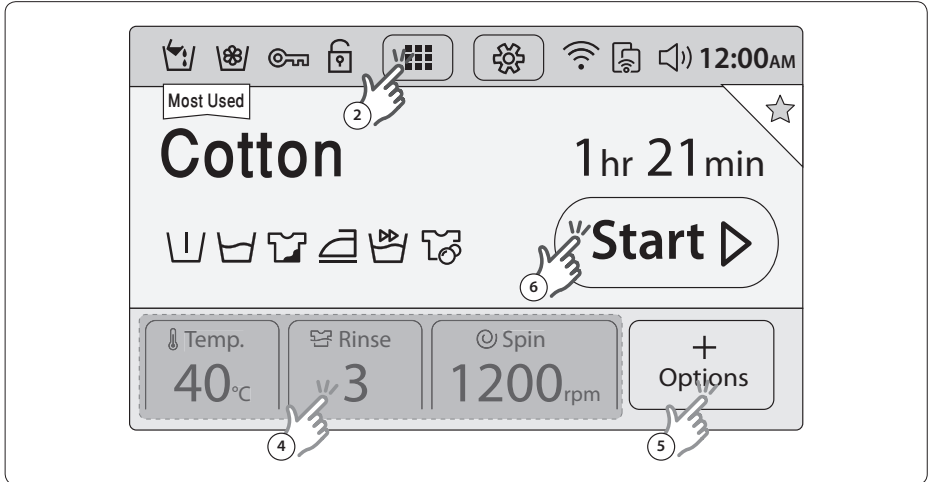

For details on each option, see “Options” on page 31.

Simple steps to start



1. Press the **Power** button to display the main screen.
 2. On the main screen, tap the **Course** icon on the top centre to display the course tile.
 3. Select a course. The washing machine supports 22 courses.
 4. Change the course settings (**Temp.**, **Rinse**, and **Spin**) if necessary.
 5. Tap the **Options** icon at the bottom right corner. Then, select options and change the option settings.
 6. Tap **Start**.
-  The washing machine has the default course settings and options available for each course. You can accept the default or make changes to your preference.
 - You can select a course on the main screen. Simply swipe the screen to the left to open the next course. To return to the previous list, simply swipe to the right.

Course overview

Standard courses

Course	Description & Max load (kg)	
Favourite	<ul style="list-style-type: none">• Add the current course configuration to the Favourite list, and quickly access the course configuration later. You can add up to 4 custom courses, which appear at the start of the course tile.	-
Most Used	<ul style="list-style-type: none">• The most frequently used course is displayed on the upper left corner of the main screen by default.	-
Auto Optimal Wash	<ul style="list-style-type: none">• Auto Optimal Wash adjusts the detergent amount and the course cycles according to the laundry weight and contamination level. This is best used with the Auto Dispense feature.	Max
Cotton	<ul style="list-style-type: none">• For cottons, bed linens, table linens, underwear, towels, or shirts.• The washing time and the number of rinse cycles are automatically adjusted according to the load.	Max
Synthetics	<ul style="list-style-type: none">• For blouses or shirts that are made of polyester (diolen, trevira), polyamide (perlon, nylon), or the like.	5
Denim	<ul style="list-style-type: none">• Featuring a higher water level in the main wash and an extra rinse cycle to ensure that no powder detergent remains.	3
Dark Garment	<ul style="list-style-type: none">• Featuring additional rinses and reduced spinning to ensure that the laundry is washed gently and rinsed thoroughly.	4
Super Speed	<ul style="list-style-type: none">• Fast completion within 1 hour for daily items such as underwear and shirts.	5
Super Eco Wash	<ul style="list-style-type: none">• Low-temperature Eco Bubble contributes to power saving.	4
Outdoor Care	<ul style="list-style-type: none">• For outdoor clothes, skiwear, and sportswear that are made of functional materials such as spandex, stretch, and micro-fibre.	2
Baby Care	<ul style="list-style-type: none">• Featuring a high-temperature wash and extra rinses to ensure that no powder detergent remains.	4
Wool	<ul style="list-style-type: none">• Specific for machine-washable wool for loads less than 2.0 kg.• The wool course features gentle cradling and soaking to protect the wool fibres from shrinkage/distortion.• A neutral detergent is recommended.	2
Delicates	<ul style="list-style-type: none">• For sheer fabrics, bras, lingerie (silk), and other handwash-only fabrics.• For best performance, use liquid detergent.	2

Course	Description & Max load (kg)	
Bedding	<ul style="list-style-type: none"> For bed spreads, bed sheets, bedding covers, etc. For best results, wash only 1 type of bedding and make sure the load weighs less than 2.5 kg. 	2.5
Spin	<ul style="list-style-type: none"> Featuring an additional spin cycle to remove water thoroughly. 	-
Rinse+Spin	<ul style="list-style-type: none"> Featuring an additional rinse after applying fabric softener to the laundry. 	-
Eco Drum Clean	<ul style="list-style-type: none"> Cleans the drum by removing dirt and bacteria from the drum. Perform once every 40 washes with no detergent or bleach applied. Make sure the drum is empty. Do not use any cleaning agents for cleaning the drum. 	-
 Cotton	<ul style="list-style-type: none"> Optimal performance with lower energy for cotton fabrics, bed linens, table linens, underwear, towels, or shirts. 	Max

Specialty Cycle

Six specialty courses are designed to effectively remove specific types of stains and dirt that may accumulate on specific types of activities ranging from household work to professional mountain-climbing.

Course	Description & Max load (kg)	
Cooking&Dining	<ul style="list-style-type: none"> This course removes food spills and cooking stains efficiently. 	4
Gardening	<ul style="list-style-type: none"> This course removes grass and mud/dirt stains and cleans sweat and skin oils efficiently. 	4
Active Sports	<ul style="list-style-type: none"> This course removes grass, soil, mud, light food stains, sweat, and make-up efficiently. Do not use this course for waterproof clothing. This may result in damage to the waterproof or breathable capabilities. 	4
Active Kids	<ul style="list-style-type: none"> The Active Kids course is for most children's clothing. This course removes food, fruit juice, drinks, mud, soil, ink, and crayon stains efficiently. 	4
Working&Everyday	<ul style="list-style-type: none"> The Working&Everyday course is for lightly soiled clothing. This course removes light ink and pencil stains and cleans normal day to day stains efficiently. 	4
Hygiene Care	<ul style="list-style-type: none"> This course removes skin oils and blood stains efficiently. 	4

Options

Available options differ depending on the course. Inactive options for a specific course are greyed out.

Options	Description
Quick Wash	<ul style="list-style-type: none"> • Specific for less soiled garments for loads less than 2 kg. • It takes a minimum of about 15 minutes, depending on the conditions such as the water pressure, water hardness, and/or extra options selected. • The Quick Wash time increases in this sequence: Off > 15 min > 20 min > 30 min > 40 min > 50 min > 60 min. • A recommended amount of detergent is less than 20 g (for a 2 kg load).
Pre Wash	<ul style="list-style-type: none"> • This will add a preliminary washing cycle before the main wash cycle.
Soaking+	<ul style="list-style-type: none"> • This option effectively removes stains by soaking the laundry. • Each soak cycle tumbles the drum for 1 minute and stands still for 4 minutes. You can set the Soaking+ time between 30 minutes and 150 minutes.
Intensive	<ul style="list-style-type: none"> • For badly soiled laundry. The operation time for each cycle is longer than normal.
Easy Iron	<ul style="list-style-type: none"> • The spinning speed decreases to reduce wrinkles. • Set the spinning speed up to 800 rpm.
Delay End	<ul style="list-style-type: none"> • The displayed time refers to the end time of a selected course.

Delay End

You can set the washing machine to finish the current course a specific number of hours later. This is useful if you want to finish the wash by the time you come home from work, for example.

1. Select a course. Then change the course settings if necessary.
2. Tap the **Options** icon at the bottom right corner.
Then, select options and change the option settings.
3. Tap **Delay End**.
4. Use the arrows to set the end time of the current course, and tap **Start**.



- To cancel the option, tap **Cancel** and return to the Options screen.

Example

You want to finish a two-hour course 3 hours from now. For this, you add the Delay End option to the current course with a 3-hour setting, and press the Start/Pause button at 2:00 p.m. Then, what happens? The washing machine starts operating at 3:00 p.m., and ends at 5:00 p.m. Provided below is the time line for this example.



Settings

Child Lock

To prevent accidents by children or infants, Child Lock locks all buttons except for the **Settings** button.

You can access the Child Lock menu from the Settings screen or the Quick panel bar.

- To set the Child Lock, tap **Settings**, and tap the **Child Lock** button.
- To activate Child Lock, press and hold the **Activate** button for 3 seconds.
- To deactivate Child Lock temporarily, press and hold the **Temporarily Deactivate** button for 3 seconds.
- To deactivate Child Lock completely, press and hold the **Deactivate** button for 3 seconds.
-  • To add detergent or more laundry in the drum, or to change the course settings whilst Child Lock is active, you must first deactivate the Child Lock.
 - The Child Lock will be reactivated one minute after it stops temporarily

Drum Light

- To turn the Drum Light on or off, tap **Settings**, and slide the **Drum Light** bar to **On** or **Off**.
- The drum light turns off automatically after 5 minutes.

Auto Dispense

The washing machine provides a two-compartment dispenser: one for detergent, and the other for fabric softener. The Auto Dispense unit dispenses an appropriate amount of detergent and fabric softener into the drum according to the course and cycle.

To enable Auto Dispense

1. Tap **Settings > Auto Dispense**.
2. Slide the **Auto Detergent** bar to **On**, and set the **Amount** and the **Water Hardness**.
3. Slide the **Auto Softener** bar to **On**, and set the **Amount** and the **Concentration**.
4. Tap **Save**.

Brightness

Set the brightness of the LCD screen

- Tap **Settings**, and tap the (-/+) signs to increase or decrease the brightness level.

Sound Theme

Set the volume level and beep melody.

1. Tap **Settings > Sound Theme**.
2. To adjust the volume, tap the (-/+) signs to increase or decrease the volume level.
3. To select a beep melody, tap a theme in the list.

Date & Time

The default time is set to the 12-hour format.

1. Tap **Settings > Date & Time**.
2. Tap the arrows to change the time for each time element. For example, to change the date, use the arrows above and below the date element.
3. To switch between the **AM** and **PM** elements, simply tap the corresponding element.
4. Tap **Save**.

Language

Select a preferred menu language.

- Tap **Settings > Language**, and select a preferred menu language.

Network

Auto setup

The washing machine supports Wi-Fi protocols of WEP, TKIP, and AES, but it does not come with a router (AP).

1. Tap **Settings > Network**, and then slide the **Network** bar to **On**. The AP list appears.
2. Tap a network provider, and provide a password if asked.
3. Tap **OK**. When completed successfully, the selected network provider is ticked.

Manual setup

1. Enable Wi-Fi connection as instructed above.
2. Tap **Set IP > Manual**.
3. Provide an IP Address, Subnet mask, Gateway, and DNS, and then tap **OK**.

Wi-Fi connection

Once the network connection is established, the next time you want to turn the Wi-Fi connection on or off, slide the **Network** bar to **On** or **Off**.

Easy Connection

Easy Connection enables you to easily configure the network settings including the authentication procedure.

Smart control

With Smart Control, you can control the washing machine on your mobile device. Tap this icon to turn the Smart control function on or off.

1. Tap **Settings** > Slide the **Smart Control** bar to **On**.
2. Back on the main screen, activate Smart Control.
3. Tap **Deactivate** to disable the function, Smart Control deactivated.



- The icon is greyed out if Smart Control is not activated.
- Manipulation such as icon tapping or button pressing on the washing machine will deactivate Smart Control.
- If wireless network not connected. Smart Control is not available.
- Select a connection method to external devices when enabling Smart Control.

Eco Check

The energy/water efficiency of the 4 most recently used courses is displayed with a technical summary of power consumption, water levels, course settings, and options.

1. Tap **Settings** > **Eco Check**. A summary screen of the most recent 4 courses appears.
2. Tap a course to display a technical summary of the selected course.

Self Check

The washing machine performs self-diagnosis on the current system. Operation errors and machine problems can be found on the results screen.

- Tap **Settings** > **Self Check** > **Start**.

Calibration

Calibration ensures accurate weight detection by the washing machine. Make sure the drum is empty before running Calibration.

1. Tap **Settings** > **Calibration** > **Start**.
 - The door will be locked during the operation.
 - The drum keeps rotating clockwise and anticlockwise for several minutes.
2. When complete, the washing machine turns off automatically.

Update

When updates are available, the update notification appears on the screen.

To check the current firmware version

1. Tap **Settings** > **Update** to display the current firmware version.
2. To update the firmware manually, tap **Update**.

To update the firmware automatically

1. Tap **Auto Update** on the **Settings** screen.
2. Slide the **Auto Update** bar to **On**. The update proceeds without notification when updates are available.



WARNING

Do not unplug the power cable of the washing machine or the router during the update.

Help

Refer to the user guide for product usage, and check the troubleshooting section against a problem.

- Tap **Settings** > **Help**.

Samsung Smart Washer app

The Samsung Smart Washer app allows you to control some functions of the washing machine on your mobile device.

Download

1. Search for Samsung Smart Washer at the Play Store or the Apple Store.
2. Download and install the app on your mobile device.
3. Run the Samsung Smart Washer app on your mobile device.

Connect to the washing machine

The washing machine must be connected to a Wi-Fi network.

Indoor control

To enable this mode, the mobile device must be connected to the same network as the washing machine.

1. On the mobile device, tap **Indoor control** to display a list of available washing machine models.
2. Tap the model name of a washing machine to connect, and then tap **OK**. The authentication window appears.
3. On the washing machine, tap **Settings**, and slide the **Smart Control** bar to **On**. The authentication procedure begins.



The authentication procedure is required just once for the first use.

Outdoor control

To enable this mode, the washing machine must be registered to the **Samsung Smart Appliance** site (www.samsungsmartappliance.com).

1. On the washing machine, tap **Settings**, and slide the **Smart Control** bar to **On**.
2. On the mobile device, tap **Outdoor control**, and provide the login credentials.
A list of registered devices appears.
3. Tap a device that you want to control from the list. Now, a remote connection will be established automatically between the washing machine and the mobile device.



No authentication procedure is required.

Registration

Register your washing machine to the Samsung Smart Appliance site (www.samsungsmartappliance.com), and get remote access to the washing machine. The washing machine must be connected to a Wi-Fi network.

1. Go to the **Samsung Smart Appliance** website (www.samsungsmartappliance.com).
2. Provide your Samsung account credentials to log in. If not a registered user, click Create a Samsung account and follow the onscreen instructions.
3. Click **My Page > Add device**, and provide the MAC address of the washing machine. To check the MAC address, tap **Settings > Network** on the washing machine.
4. Click **Get Approval**.
5. Tap **Settings** on the washing machine, and tap **OK** if asked to get approval.

Registered washing machines are found in the device list of the website.



Hereby, Samsung Electronics, declares that this washing machine is in compliance with the essential requirements and other relevant provisions of Directive 1999/5/EC.

The official Declaration of conformity may be found at <http://www.samsung.com>, go to Support > Search Product Support and enter the model name.

Samsung Smart Home app

The Samsung Smart Home app enables you to access and control the washing machine on the move.

Installation

1. Visit Google Play Store for Android devices, or Apple App Store for iOS devices, and search for Samsung Smart Home to select.
2. Download and install the Samsung Smart Home app on your mobile device.



- The Samsung Smart Home app supports Android OS 4.0 (ICS) or later which is optimized for Samsung smartphones (Galaxy S and Galaxy Note series). Some functions of this app may work differently on other devices.
- This app supports iOS 7 or later for iPhone models.
- For enhanced performance, the UI design of this app is subject to change without notice.
- For iPhone models, this app is scheduled to be available from the latter half of 2014 at Apple App Store.

Preparation

1. To enable the app, you are required to enter your Samsung account. You will be guided in creating a Samsung account if you don't have one directly on the app. No other app is necessary for this purpose.
2. To enable the app, first register your washing machine to the Samsung Smart Home service.
 - 1) Select the washing machine in the device list of the Samsung Smart Home app.
 - 2) Enter the necessary information about the wireless AP that you use for wireless connection.
 - 3) Follow the onscreen instructions to configure settings for the washing machine.
 - 4) On the washing machine, select **Settings > Easy Connection** to configure the network settings.
 - 5) When complete, you will see the washing machine icon on the app.



CAUTION

- Wi-Fi uncertified routers may fail to establish the connection.
- If installing the washing machine and the AP near microwave ovens or electric hairdryers, Smart Control may not function properly due to electric interference.
- The washing machine supports only the Wi-Fi 2.4Ghz protocols.
- The surrounding environment may affect the wireless network performance.



- If you run the app without being logged in, you will see the Account guidance screen. Once logged in, you can change your account settings in **Settings > Account**.
- Samsung smartphone users can automatically log into the app once registering their account in **Settings**.

Using the Samsung Smart Home app

Key features

- **Integrated control of Samsung smart appliances**

Register your Samsung smart devices to the Samsung Smart Home service that you can leverage for easy access. Select the washing machine icon on the app to access the core features of the washing machine on the move.

- **Master key**

The master key consists of 4 modes: Going out, Coming home, Good night, and Good morning.

- **Chat controls**

Chat between smart devices and get the information to control the device.

- **Home monitoring**

Use the built-in camera of your smart device to monitor the living room while on the move.

- **Customer support**

Download the product manual or request for a service repair.



Some features of this service may not be available on the washing machine.

Samsung Smart Home Washing Machine app

Control and monitor the washing machine both home and on the move.

1. Register the washing machine to the Samsung Smart Home app.
2. Download the Samsung Smart Home Washing Machine app from Google Play Store or Apple App Store and install it on your mobile device.
3. To enable remote control, turn on Smart Control on the washing machine.
4. Select the washing machine icon on the mobile device and tap **Start**.



This product is a smart washing machine that supports the Samsung Smart Home service.

For more information, visit www.samsung.com.

Maintenance

Keep the washing machine clean to prevent deteriorated performance and to preserve its life cycle.

Eco Drum Clean

Perform this course regularly to clean the drum and to remove bacteria from it.

1. Tap **Course** > **Eco Drum Clean**.
2. Move to the main screen, and tap **Start**.



The water temperature for Eco Drum Clean is set to 70 °C, which cannot be changed.



CAUTION

Do not use any cleaning agents for cleaning the drum. Chemical residue in the drum deteriorates the washing performance.

Eco Drum Clean reminder

- The Eco Drum Clean reminder appears on the main screen once every 40 washes. It is advisable to perform the Eco Drum Clean regularly.
- When you first see this reminder, you can ignore the reminder (up to 6 times) by tapping **Remind later**. From the 7th wash, the reminder does not appear. However, it appears again on the second 40th wash.

Emergency drain

In case of a power failure, drain the water inside the drum before taking out the laundry.

1. Unplug the power cord of the washing machine from the main socket.
2. Gently press the top area of the filter cover to open.

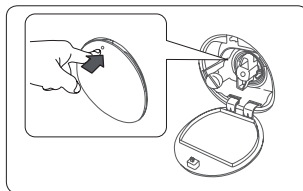

3. Gently pull out the emergency drain tube.

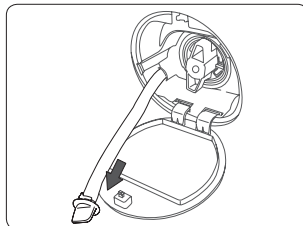

4. While holding the end of the drain tube, open the tube cap.

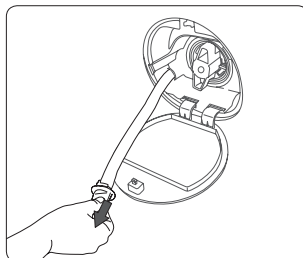

5. Let the water run into a container.
6. Close the tube cap, and reinsert the drain tube.
7. Close the filter cover.

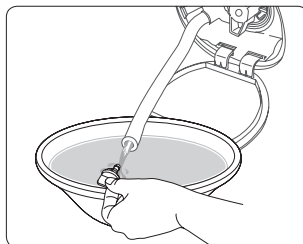

Cleaning

Surface of the washing machine

Use a soft cloth with a nonabrasive household detergent. Do not spray water onto the washing machine.

Mesh filter

Clean the mesh filter of the water supply hose once or twice a year.

1. Turn off the washing machine, and unplug the power cord.
2. Close the water tap.
3. Loosen and disconnect the water supply hose from the back of the washing machine. Cover the hose with a cloth to prevent water from gushing out.

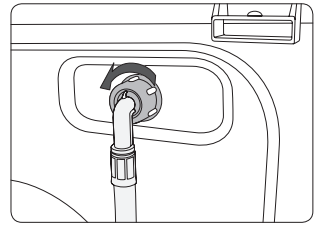

4. Use pliers to pull out the mesh filter from the inlet valve hole.
5. Submerge the mesh filter deeply in water so that the threaded connector is also submerged.
6. Dry the mesh filter completely in the shade.
7. Reinsert the mesh filter into the water supply hose, and place the water supply hose in the original position.
8. Open the water tap.

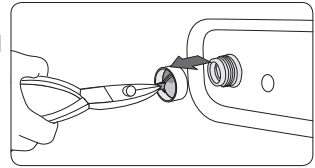

 If the mesh filter is clogged, an error code of **"4E"** appears on the screen.

Debris filter

It is advisable to clean the debris filter 5 or 6 times a year to prevent its clogging. A clogged debris filter may reduce the bubble effect.

1. Turn off the washing machine, and unplug the power cord.
2. Drain the remaining water inside the drum by referring to “**Emergency drain**” on page 42.
3. Open the filter cover using a coin or key.
4. Turn the debris filter cap to the left, and drain off the remaining water.
5. Remove the debris filter.

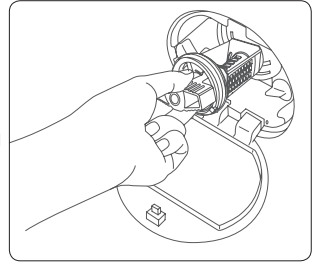

6. Clean the debris filter using soft brushes. Make sure the drain pump propeller inside the filter is unclogged.
7. Reinsert the debris filter, and turn the filter cap to the right.

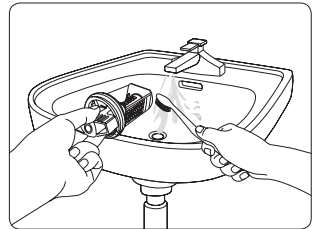

- To open the safety filter cap, push in and turn it anticlockwise. The spring of the cap helps to open the cap.
- To close the safety filter cap, turn it clockwise. The spring makes a rattling sound, which is normal.

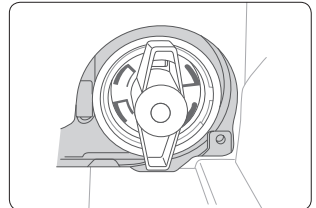

- If the debris filter is clogged, an error code of “**5E**” appears on the screen.



CAUTION

- Make sure the filter cap is closed properly after cleaning the filter. Otherwise, this may cause a leak.
- Make sure the filter is inserted properly after cleaning it. Otherwise, this may cause an operational failure or a leak.

Auto Dispense unit

The Auto Dispense unit must be cleaned regularly to ensure proper operation at all times.

1. Remove the Auto Dispense unit from the washing machine.

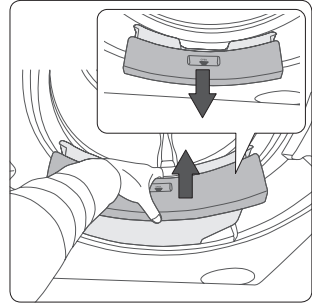

2. Wipe out the recess of the Auto Dispense unit using a dry cloth.

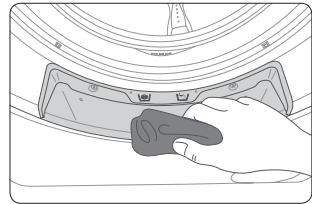

3. Remove two knobs of the Auto Dispense unit as well as the two caps at the bottom, and run water through the Auto Dispense unit to clean the inner area.

Do not shake the Auto Dispense unit as you may be splattered with water from the vent of the Auto Dispense unit.

4. Reinsert knobs and caps in the original position.
5. Reinsert the Auto Dispense unit in the original position.

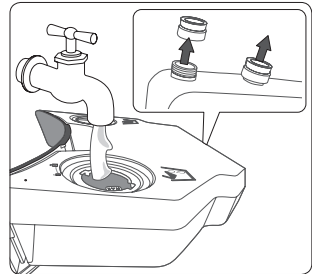

Recovery from freezing

The washing machine may freeze when it drops below 0 °C.

1. Turn off the washing machine, and unplug the power cord.
2. Pour warm water over the water tap to loosen the water supply hose.
3. Disconnect the water supply hose, and soak it in warm water.
4. Pour warm water into the drum and leave it for about 10 minutes.
5. Reconnect the water supply hose to the water tap.



If the washing machine still doesn't operate normally, repeat the above steps until it operates normally.

Care against an extended time of disuse

Avoid leaving the washing machine unused for an extended time.

If this is the case, drain the washing machine and unplug the power cord.

1. On the main screen, tap **Course** > **Cotton** with an option of **Quick Wash**.
2. Empty the drum, and tap **Start**.
3. When the course is complete, close the water tap and disconnect the water supply hose.
4. Turn off the washing machine, and unplug the power cord.
5. Open the door to let air circulate through the drum.

Troubleshooting

Checkpoints

If you encounter a problem with the washing machine, first check the table below and try the suggestions.

Problem	Action
The washing machine won't start.	<ul style="list-style-type: none"> • Make sure the washing machine is plugged in. • Make sure the door is properly closed. • Make sure the water tap is open. • Tap Start again on the main screen.
Water supply is insufficient, or no water is supplied.	<ul style="list-style-type: none"> • Open the water tap fully. • Make sure the water supply hose is not frozen. • Make sure the water supply hose is not kinked or clogged. • Clean the filter on the water supply hose.
The washing machine vibrates badly or makes noise.	<ul style="list-style-type: none"> • Make sure the washing machine is installed on a level floor. If the floor is not level, use the levelling feet to adjust the level. • Make sure that the shipping bolts are removed. • Make sure the washing machine is not touching any other object. • Make sure the laundry load is balanced.
The washing machine does not drain and/or spin.	<ul style="list-style-type: none"> • Make sure the drain hose is straightened all the way to the drain system. • Make sure the debris filter is not clogged.
The door won't open.	<ul style="list-style-type: none"> • Tap Start to stop operating the washing machine. • The door remains locked during the heating cycle of the Sanitize course. • It may take several seconds to disengage the locking mechanism.
The washing machine produces lots of bubbles.	<ul style="list-style-type: none"> • Check if the Auto Detergent and Auto Softener settings are properly specified. • Make sure you use the recommended types of detergent as appropriate.
I cannot apply additional detergent.	<ul style="list-style-type: none"> • Check the remaining amount of detergent and fabric softener to see if they are already up to the limit. • Make sure the Auto Dispense function is enabled, with both the Water Hardness and Concentration settings properly specified.

If a problem persists, contact a local Samsung service centre.

Information codes

If the washing machine fails to operate, you may see an information code on the screen. Check the table below and try the suggestions.

Problem	Action
DE	<ul style="list-style-type: none">• Make sure the door is properly closed.• Make sure laundry is not caught in the door.
4E	<ul style="list-style-type: none">• Make sure the water tap is open.• Make sure the washing machine is operating with sufficient water pressure,• Clean the mesh filter as it may be clogged.
5E	<ul style="list-style-type: none">• Clean the debris filter as it may be clogged.• Make sure the drain hose is not kinked all the way to the drain system.• Clean the mesh filter as it may be clogged.
UE	<ul style="list-style-type: none">• The laundry load is unbalanced. Spread the laundry evenly.
CE/3E/UC	<ul style="list-style-type: none">• This is not user-repairable. Contact a local Samsung service centre.

If any information code keeps appearing on the screen, contact a local Samsung service centre.

Specifications

Protecting the environment

























- This appliance is manufactured from recyclable materials. If you decide to dispose of this appliance, please observe local waste disposal regulations. Cut off the power cord so that the appliance cannot be connected to a power source. Remove the door so that animals and small children cannot get trapped inside the appliance.
- Do not exceed the detergent quantities recommended in the detergent manufacturer's instructions.
- Use stain removal products and bleaches before the wash cycle only when strictly necessary.
- Save water and electricity by only washing full loads (the exact amount depends upon the program used).

Declaration of conformity

This appliance complies with European safety standards, EC directive 93/68 and EN Standard 60335.

Fabric care chart

The following symbols provide garment care directions. The care labels include four symbols in this order: washing, bleaching, drying and ironing (and dry cleaning when necessary). The use of symbols ensures consistency among garment manufacturers of domestic and imported items. Follow the care label directions to maximize garment life and reduce laundry problems.





	Resistant material		Do not iron
	Delicate fabric		Can be dry cleaned using any solvent
	Item can be washed at 95 °C		Dry Clean
	Item can be washed at 60 °C		Dry clean with perchloride, lighter fuel, pure alcohol or R113 only
	Item can be washed at 40 °C		Dry clean with aviation fuel, pure alcohol or R113 only
	Item can be washed at 30 °C		Do not dry clean
	Hand wash only		Dry flat
	Dry clean only		Can be hung to dry
	Can be bleached in cold water		Dry on clothes hanger
	Do not bleach		Tumble dry, normal heat
	Can be ironed at 200 °C max		Tumble dry, reduced heat
	Can be ironed at 150 °C max		Do not tumble dry
	Can be ironed at 100 °C max		

Specification sheet (Only for EU models)

 The design and specifications are subject to change without notice for quality improvement purposes.

According to Regulation (EU) No. 1061/2010

Samsung			
Model Name		WW10H9*****	
Capacity	kg	10	
Energy Efficiency			
A + + + (highest efficiency) to D (least efficient)		A+++	
Energy Consumption			
Annual Energy Consumption (AE_C) ¹⁾	kWh/yr	119	
Energy consumption (E_t.60) Cotton 60 °C at full load	kWh	0.50	
Energy consumption (E_t.60.1/2) Cotton 60 °C with partial load	kWh	0.52	
Energy consumption (E_t.40.1/2) Cotton 40 °C with partial load	kWh	0.52	
Weighted power off-mode (P_o)	W	0.48	
Weighted Power in left-on mode (P_l)	W	10	
Annual water consumption (AW_c) ²⁾	L/yr	11500	
Spin efficiency class ³⁾			
A (most efficient) to G (least efficient)		A	A
Maximum Spin Speed	rpm	1600	1400
Residual moisture	%	44	44
Programs to which the information on the label and the Sheet relate		e Cotton 60 °C and 40 °C ⁴⁾	
Program duration of the standard program			
Cotton 60 °C at full load	min	305	
Cotton 60 °C for partial load	min	305	
Cotton 40 °C with partial load	min	305	
Weighted time in left-on mode	min	8	
Airborne noise emissions			
Wash	dB (A) re 1 pW	46	46
Spin	dB (A) re 1 pW	72	70
Dimensions			
Unit dimensions	Height	mm	850
	Width	mm	600
	Depth ⁵⁾	mm	600
Net weight	kg	87	
Gross weight	kg	89	
Package weight	kg	2.5	
Water Pressure	kPa	50-800	
Electrical connection			
Voltage	V	220-240	
Power consumption	W	2000-2400	
Frequency	Hz	50	
Name of Company		Samsung Electronics Co., Ltd.	

1. Annual energy consumption is based on 220 standard washing cycles for  Cotton course at 60 °C and 40 °C at full and partial load, and the consumption of off and left-on modes. Actual energy consumption will depend on how the appliance is used.
2. Annual water consumption is based on 220 standard washing cycles for  Cotton course at 60 °C and 40 °C at full and partial load. Actual water consumption will depend on how the appliance is used.
3. Spin extraction is very important when you use a clothes dryer to dry your clothes. The energy for drying costs much higher than the energy for washing. Washing with the high spin saves more energy in drying your clothes in a clothes dryer.
4. The  Cotton 60 °C and  Cotton 40°C programs are the 'standard cotton 60 °C program' and the 'standard cotton 40 °C program'. They are suitable to clean normally soiled cotton laundry and they are the most efficient (concerning water and energy consumption) for this type of laundry.
Please run Calibration after the installation (see "Calibration" on page 35).
In these programs the actual water temperature may differ from the declared temperature.
5. Distance to the wall from the unit is not included in the depth dimension.

Information of main washing programmes

Model	Course	Temperature (°C)	Capacity (kg)	Program Time (min)	Residual Moisture Content (%)		Water Consumption (ℓ/cycle)	Energy Consumption (kWh/Cycle)
					1600rpm	1400rpm		
WW10H9*****	Cotton	20	5	138	50	51	80	0.35
		40	5	305	44	45	48	0.52
	 Cotton	60	5	305	44	45	48	0.52
			10	305	43	44	60	0.5
	Synthetics	40	5	148	30	30	60	0.82

The values on the table have been measured under the conditions specified in Standard IEC60456/EN60456. Actual values will depend on how the appliance is used.



The above test results are based on using the powder detergent, with Auto Dispense off.

Specification sheet

TYPE		FRONT LOADING WASHING MACHINE	
MODEL NAME		WW10H9*****	
DIMENSIONS		W600xD600xH850(mm)	
WATER PRESSURE		50 kPa ~ 800 kPa	
WATER VOLUME		68 ℓ	
NET WEIGHT		87 kg	
WASH AND SPIN CAPACITY		10.0 kg	
POWER CONSUMPTION	WASHING	220 V	150 W
		240 V	150 W
	WASHING AND HEATING	220 V	2000 W
		240 V	2300 W
	SPIN	220~240 V	700 W
PUMPING	30 W		
SPIN REVOLUTIONS		rpm	1400, 1600

 Cotton 60 °C is recommended for a normally soiled cotton load. (Only for Singapore models)

Memo

Memo



**Complies with
IDA Standards
DA100790**

QUESTIONS OR COMMENTS?

COUNTRY	CALL	OR VISIT US ONLINE AT
UK	0330 SAMSUNG (7267864)	www.samsung.com/uk/support
EIRE	0818 717100	www.samsung.com/ie/support
NIGERIA	0800-726-7864	www.samsung.com/africa_en/support
SOUTH AFRICA	0860 SAMSUNG (726 7864)	www.samsung.com/support
SINGAPORE	1800-SAMSUNG(726-7864)	www.samsung.com/sg/support



DC68-03377D-03

Free Manuals Download Website

<http://myh66.com>

<http://usermanuals.us>

<http://www.somanuals.com>

<http://www.4manuals.cc>

<http://www.manual-lib.com>

<http://www.404manual.com>

<http://www.luxmanual.com>

<http://aubethermostatmanual.com>

Golf course search by state

<http://golfingnear.com>

Email search by domain

<http://emailbydomain.com>

Auto manuals search

<http://auto.somanuals.com>

TV manuals search

<http://tv.somanuals.com>