

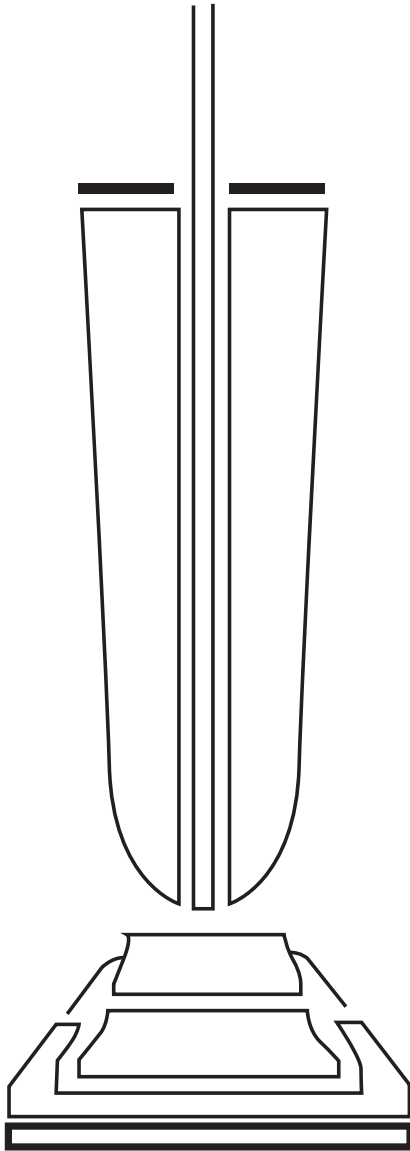

# SYSTEM\_PRO

## Heavy Duty Upright Vacuum Cleaner

Household Type  
**Owner's Guide**  
Model S634



### **IMPORTANT**

Do not return this product to the store. Call 1-800-800-8975\* Monday - Friday, 8 am to 7:30 pm CST and 10 am to 6:30 pm Saturday or visit our web site, [www.sanitairevac.com](http://www.sanitairevac.com) for any of the following:

- assembly problems
- replacement of broken or missing items
- to order replacement parts and accessories
- to locate the nearest Sanitaire Warranty Station

\*En Mexico llame al (55) 5343-4384

[www.sanitairevac.com](http://www.sanitairevac.com)

### **PLEASE RETAIN**

We suggest you record the model, type and serial numbers below. They are located on the silver rating plate on your cleaner. For prompt and complete service information, always refer to these numbers when inquiring about service.

Model & Type \_\_\_\_\_

Serial No. \_\_\_\_\_

It is also important to keep your receipt as proof of date of purchase.

## Index

Important Safeguards .....	2
Service Information .....	2
Assemble .....	3
Use.....	4
Dust Bag .....	4-5
Brush Roll Belt .....	5-6
Brush Roll .....	6
Headlight.....	6
Warranty.....	7

## GENERAL INFORMATION

To reduce the risk of electric shock, this appliance has a polarized plug (one blade is wider than the other). The plug will fit in a polarized outlet only one way. If the plug does not fit fully in the outlet, reverse the plug. If it still does not fit, contact a qualified electrician to install the proper outlet. Do not change the plug in any way.

The bag may have come dislodged in shipping. Check the bag to insure proper seating before attempting to use the cleaner. Do not operate the cleaner without a dust bag or the filters.

The cleaner is designed to pick up dirt and dust particles. Avoid picking up hard or sharp objects with the cleaner to avoid bag breakage, hose clogging, or possible motor damage.

## Service Information

The instructions in this booklet serve as a guide to routine maintenance. If additional service is required, telephone toll free:

**USA: 1-800-800-8975**

**Mexico: (55) 5343-4384**

**Canada: 1-800-800-8975**

If you prefer, you can write to Electrolux Home Care Products North America, Consumer Service, P.O. Box 3900 Peoria, Illinois 61612, USA. In Canada write to Electrolux Home Care Products North America, 866 Langs Drive, Cambridge, Ontario N3H 2N7. Refer to The Sanitaire Limited Warranty for complete service information.



**DO NOT OIL the motor or the brush roll at any time. The bearings are permanently lubricated and sealed.**

# IMPORTANT SAFEGUARDS

When using an electrical appliance, basic precautions should always be followed, including the following:

**READ ALL INSTRUCTIONS  
BEFORE USING THIS VACUUM CLEANER.**

## WARNING

To reduce the risk of fire, electric shock, or injury:

- Do not use outdoors or on wet surfaces.
- **Do not leave vacuum cleaner when plugged in.** Turn off the switch and unplug the electrical cord when not in use and before servicing.
- Do not allow to be used as a toy. Close attention is necessary when used by or near children.
- Use only as described in this manual. Use only manufacturer's recommended attachments.
- Do not use with damaged cord or plug. If vacuum cleaner is not working as it should, has been dropped, damaged, left outdoors, or dropped into water, return it to a service center before using.
- Do not pull or carry by cord, use cord as a handle, close a door on cord, or pull cord around sharp edges or corners. Do not run vacuum cleaner over cord. Keep cord away from heated surfaces.
- Do not use extension cords or outlets with inadequate current carrying capacity.
- Turn off all controls before unplugging.
- Do not unplug by pulling on cord. To unplug, grasp the plug, not the cord.
- Do not handle plug or vacuum cleaner with wet hands.
- Do not put any object into openings. Do not use with any opening blocked; keep free of dust, lint, hair, and anything that may reduce airflow.
- This vacuum cleaner creates suction and contains a revolving brush roll. Keep hair, loose clothing, fingers, and all parts of body away from openings and moving parts.
- Do not pick up anything that is burning or smoking, such as cigarettes, matches, or hot ashes.
- Do not use without dust bag in place.
- Belt pulleys can become hot during normal use. To prevent burns, avoid touching the belt pulley when servicing the drive belt.
- Use extra care when cleaning on stairs.
- Do not use to pick up flammable or combustible liquids such as gasoline, or use in areas where they may be present.
- Store your cleaner in a cool, dry area.
- Keep your work area well lighted.
- Unplug electrical appliances before vacuuming them.

# SAVE THESE INSTRUCTIONS

# HOW TO ASSEMBLE

**CAUTION:** Completely assemble vacuum cleaner before using.

Handle styles may vary. One handle has four snap pins on the back side of the handle, the other handle has two snap pins on each side. The cord hooks may be different.

## Assembly Packet

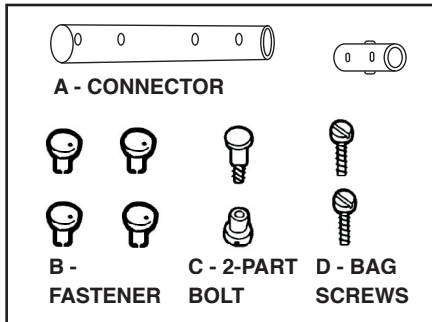

### Step 1 Handle Connector

Push connector A into the upper handle and align holes. One connector, shown, is flat on one side and the 4 pins snap into one side. The connector in Detail A has 2 snap pins on each side and alignment tabs that slide into the handle.

### Step 2 Fastener

Push fastener B into a hole and apply thumb pressure so fastener snaps into position. Secure second fastener. Repeat steps 1 and 2 to complete the assembly of the handle. See Detail B.

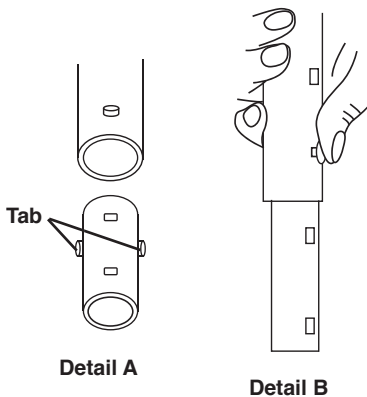

### Step 3 Handle Socket

Push handle into handle socket E so handle grip curves away from the cleaner. Align the holes, insert the 2-part bolt C and tighten.

### Step 4 Outer Bag

Hold outer bag with zipper away from handle. **Important:** To provide a good gasket seal, the bag coupling must seat firmly against the motor base and not overlap the furniture guard. Start the bag screws D by hand, then tighten with a screwdriver.

### Step 5 Bag Support

Loop the spring F onto the bag support G, located to the back of the upper cord hook.

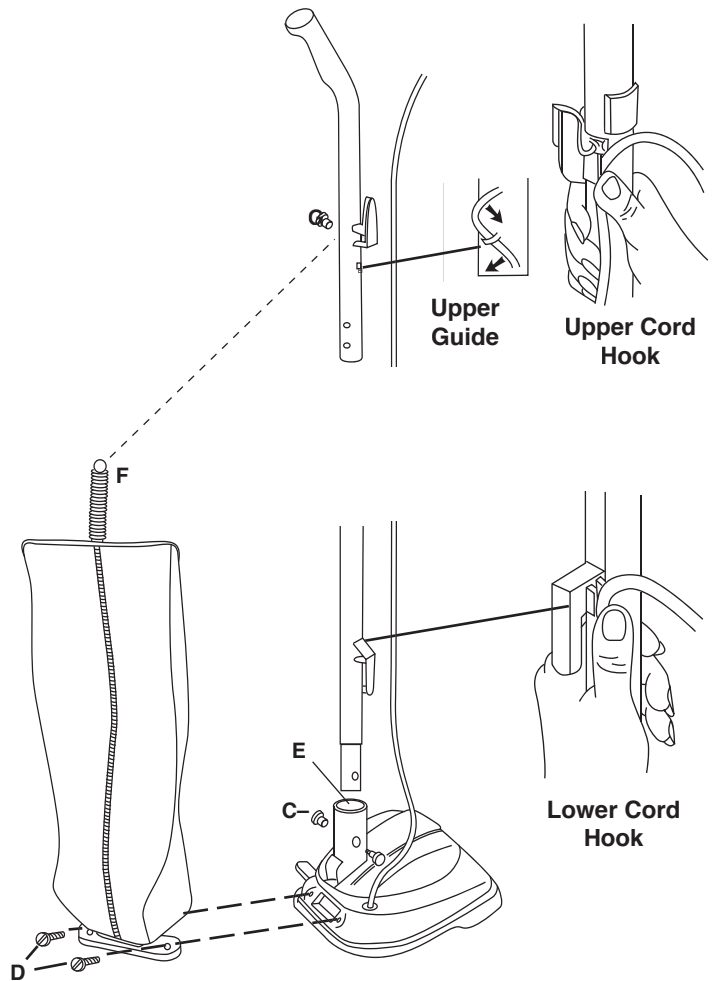

### Step 6 Cord Storage

Secure the cord in the guide below the upper cord hook as shown or secure the cord into the side of the upper cord hook.

Secure cord into lower cord hook. Pull up on cord to tighten but leave slack near the base so the cord does not strain when the handle is lowered for use. Wrap the cord around the cord hooks. Fasten the plug to the cord to prevent unwinding.

# How To Use

The upright vacuum cleaner is designed to be used on multiple types of carpeting. **Do not attempt to use the upright vacuum cleaner on bare floors**, as damage to the floor covering may result. Above the floor cleaning tools are available (optional).

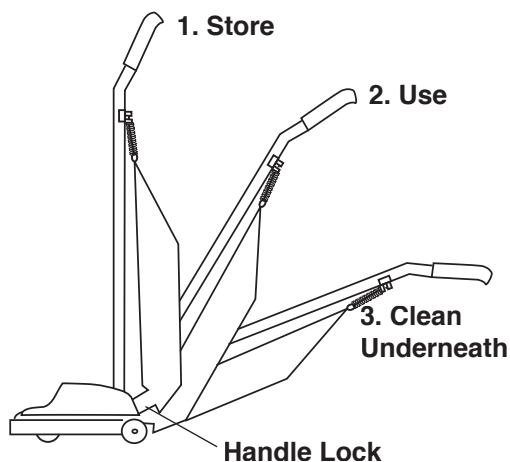
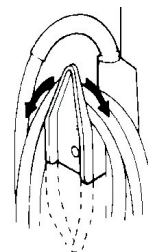

## Handle Adjustment

With the tip of the foot, press down to release the handle lock located at the left rear side of the cleaner. Move the handle and adjust it to the desired position for (1) storing upright, (2) operating the cleaner at a comfortable height for the user, and (3) cleaning underneath low furniture.

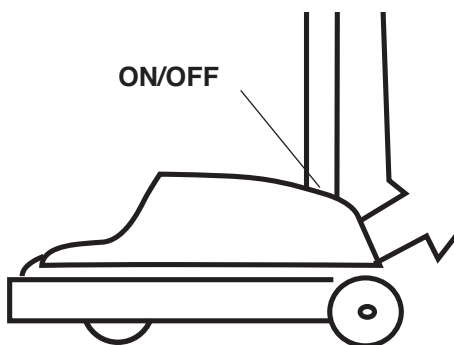

## Power Switch

The power switch is mounted on the motor hood. A push with the foot turns the motor ON; push again to turn the motor OFF.

## Cord Storage

The cleaner has two convenient cord storage hooks attached to the handle. However, some models feature a quick release cord hook on the upper handle. A downward twist of the cord hook frees the cord for quick removal. With either style, wind the cord around the hooks for storage. Fasten the plug to the cord to prevent unwinding.

## Cleaner Height Setting

**WARNING: Avoid injury. Keep loose clothing, hair, fingers, and all other parts of body away from any moving part (such as the revolving brush). Turn off the switch and unplug the cleaner before changing the cleaner height setting.**

The front of the cleaner has an adjustment that raises or lowers the cleaner base to match the type of carpet. With the cleaner cord unplugged, set the adjustment to lowest setting for maximum cleaning. If the cleaner is difficult to push, move adjustment to next highest setting until cleaner is comfortable to push. The brush roll must reach the carpet for effective cleaning.

**Make each adjustment with cleaner switch off and cord disconnected from outlet.** For ease in moving the adjustment knob, place handle in operating position and tilt cleaner back to remove weight from front wheels.

# HOW TO MAINTAIN

The instructions given in this booklet serve as a guide to routine maintenance. To avoid unnecessary service calls, check the bag, belt and brush roll often.

## Disposable Dust Bags

Paper bags play a very important role in the efficiency of a vacuum cleaner. The purpose of a paper bag is to trap dirt. But at the same time the bag must be porous enough to allow air to pass through. If the paper bag becomes clogged, no air can pass through the cleaner and no cleaning can take place, regardless of how powerful the unit is. Change the dust bag frequently. Some fine particles can restrict airflow very quickly and will decrease performance even before the bag appears to be full. For that reason, when vacuuming carpet fresheners or cleaners, powder, plaster dust, or similar fine substances, the bag may need to be changed more often.

## How To Change Disposable Dust Bag–Style F & G, PN 54924A

**CAUTION:** Turn off the switch and unplug the electrical cord before changing dust bag. Never operate the vacuum cleaner without the dust bag.

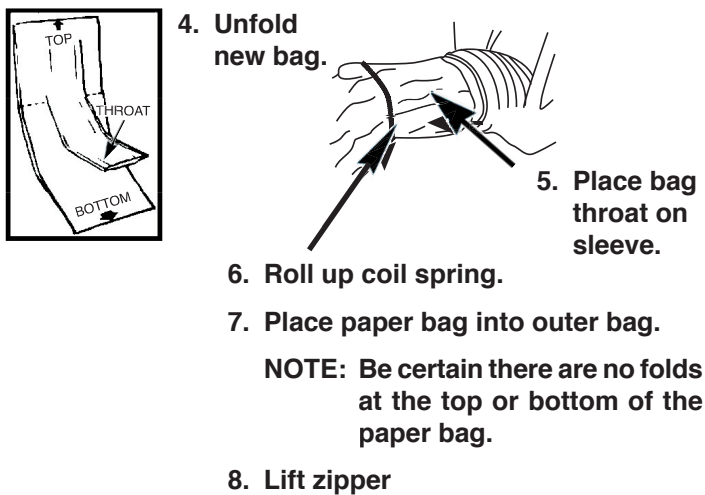
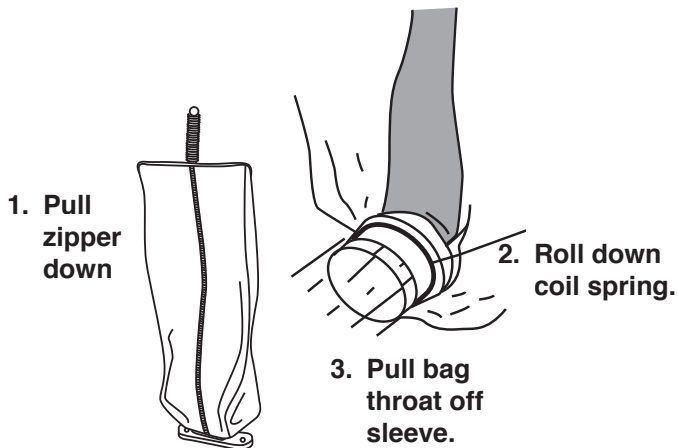

Look for the **GENUINE** EUREKA PRODUCT symbol.

Ask for GENUINE EUREKA dust bags – Style F & G.

## Cleaner Care

**CAUTION:** Turn off the switch and unplug the electrical cord before cleaning unit.

To keep the vacuum cleaner looking new, it can be wiped with a damp cloth and a mild soap solution, then thoroughly dried. Never use any type of chemical as chemicals can damage the cleaner. When not in use, the cleaner should be stored in a clean, dry place.

## Brush Roll Belt

The brush roll belt on the upright vacuum cleaner drives the brush to agitate, sweep, and comb the carpet nap. The belt should be checked regularly to be sure it is in good condition. Replace the belt if it is stretching, cracking, or slipping. Cut away any hair or thread wound around the brush roll or the belt pulley because the buildup could cause the belt to rotate unevenly.

## How To Replace A Worn Belt, Style RD, PN 52100A

**CAUTION:** Turn off the switch and unplug the electrical cord before replacing belt. Belt pulleys can become hot during normal use. To prevent injury, avoid touching the belt pulley when servicing the drive belt.

**IMPORTANT:** Improper installation of the brush roll or brush roll belt could cause carpet or cleaner damage.

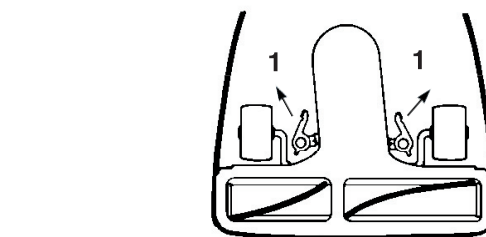

1. Release cam locks.

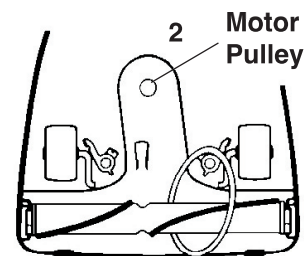

2. Pull up on belt to rotate it off the motor pulley. Lift up on brush roll and remove worn belt.

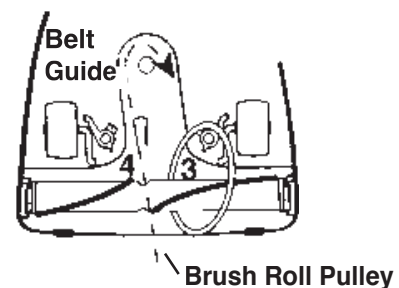

Check for brush wear, see Brush Roll instructions.

3. Place new belt around brush roll.
4. Align brush roll pulley with belt guide.

## How To Replace A Worn Belt (continued)

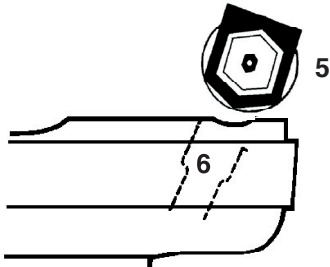

5. Place rubber end cap covers over both end caps (flat side against end cap). Align holes and secure. Then, slant brush roll forward so end caps are in line with slots in cleaner base.
6. Push brush roll into base.

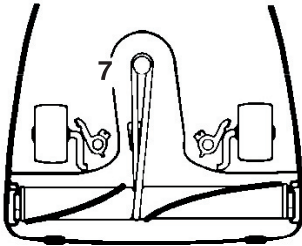

7. Place lower side of belt into belt guide and pull to stretch the belt around the left side of the motor pulley. Rotate pulley to secure belt into groove.

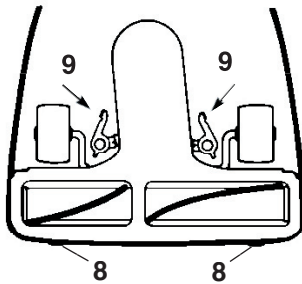

8. Place slots of bottom plate over tabs of cleaner base.
9. Seat and secure cam locks

Ask for GENUINE EUREKA replacement belts, Style RD No. 52100A.

Look for the  symbol.

## Brush Roll

The rotating brush roll sweeps and combs the carpet nap. Keep the brush roll free from hair and threads so it will continue brushing. When the bristles of the brush roll no longer touch a straight edge held against the bottom plate, the brush roll is ineffective because the bristles no longer touch the carpet nap. To maintain the most effective cleaning, the brush roll should be replaced.

## Headlight Bulb (Standard on most models), PN 40009A

**CAUTION: Turn off the switch and unplug the electrical cord before replacing headlight bulb.**

Headlight style varies by model. Locate the notches that release the tabs at either (1) top, (2) side, or (3) bottom of the lens, as illustrated. Place a screwdriver into one notch; twist or pry the screwdriver to release the lens. Repeat for the second notch on the opposite side.

Rotate the bulb socket forward. Push bulb in and turn to remove. Secure new bulb into socket and rotate bulb socket backward.

Replace the lens tabs into the top or the bottom of the hood opening. Rotate lens to position and press down at notch until the lens locks into position.

**CAUTION: Use 25 watt replacement bulb, only.**

Ask for GENUINE EUREKA replacement bulb, 40009A.

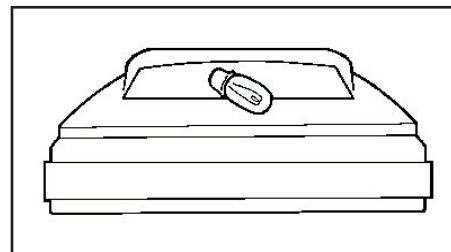
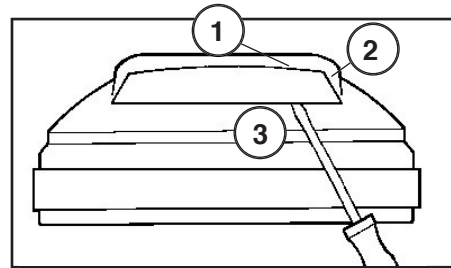



# THE SANITAIRE LIMITED WARRANTY

## What This Warranty Covers

Your Sanitaire cleaner is warranted to be free from all defects in material and workmanship in normal household use for a period of two years. The warranty is granted only to the original purchaser and members of his or her immediate household. The warranty is subject to the following provisions.

## What This Warranty Does Not Cover

- Parts of the cleaner that require replacement under normal use, such as disposable dust bags, filters, drive belts, light bulbs, and brush roll bristles.
- Damages or malfunctions caused by negligence, abuse, or use not in accordance with the Owner's Guide.
- Defects or damages caused by unauthorized service or the use of other than Genuine Eureka/Sanitaire parts.

## What Electrolux Home Care Products North America Will Do

Electrolux Home Care Products North America will, at its option, repair or replace a defective cleaner or cleaner part that is covered by this warranty. As a matter of warranty policy, Electrolux Home Care Products North America will not refund the consumer's purchase price.

## Extended Warranty for Upright Cleaner

The base of the Sanitaire Upright cleaner is warranted for five years from the original date of purchase.

## Extended Warranty for SYSTEM\_PRO Uprights

The suction motor for SYSTEM\_PRO upright cleaners is warranted for five years from the original date of purchase.

## Warranty Registration

Please fill out and return the warranty registration card accompanying your cleaner.

## Obtaining Warranty Service

To obtain warranty service you must return the defective cleaner or cleaner part along with proof of purchase to any Sanitaire Authorized Warranty Station. You will find the nearest location in the Yellow Pages, under "Vacuum Cleaners—Service and Repair." Be certain that the Warranty Station is "Sanitaire Authorized." For the location of the nearest Sanitaire Authorized Warranty Station or for service information, telephone toll free:

**USA: 1-800-800-8975**  
**Mexico: (55) 5343-4384**  
**Canada: 1-800-800-8975**

**www.sanitairevac.com**

If you prefer, you can write to Electrolux Home Care Products North America, Service Division, P.O. Box 3900, Peoria, Illinois 61612, USA. In Canada write to Electrolux Home Care Products North America, 866 Lings Drive, Cambridge, Ontario N3H 2N7.

If it is necessary to ship the cleaner outside your community to obtain warranty repair, you must pay the shipping charges to the Sanitaire Authorized Warranty Station. Return shipping charges will be paid by the Warranty Station. When returning parts for repair, please include the model, type, and serial numbers from the data plate on the cleaner.

## Further Limitations and Exclusions

Any warranty that may be implied in connection with your purchase or use of the cleaner, including any warranty of Merchantability or any warranty for Fitness For A Particular Purpose is limited to the duration of this warranty. Some states do not allow limitations on how long an implied warranty lasts, so the above limitations may not apply to you.

Your relief for the breach of this warranty is limited to the relief expressly provided above. In no event shall Electrolux be liable for any consequential or incidental damages you may incur in connection with your purchase or use of the cleaner. Some states do not allow the exclusion or limitation of incidental or consequential damages, so the above limitation or exclusion may not apply to you.

This warranty gives you specific legal rights. You may also have other rights which vary by state.



## Questions & Answers about Genuine Eureka/Sanitaire Products

**Q:** Why should I use only Genuine Eureka/Sanitaire paper bags, belts, and parts in my Eureka/Sanitaire vacuum cleaner?

**A:** Using Genuine Sanitaire Products, which are made to our exacting specifications and engineered with emphasis on quality, performance, and customer satisfaction, ensures the long life and cleaning efficiency of your vacuum cleaner. Overall, this saves you money and helps to keep your home clean.

**Q:** How can I be sure I am using only Genuine Eureka/Sanitaire products in my vacuum cleaner?

**A:** Typically, packaged products and paper bags can be identified by a Eureka or Sanitaire logo. For further identification assistance, you may call our toll-free number, 1-800-800-8975, for the location of a nearby Eureka/Sanitaire Authorized Warranty Station.

**Q:** Are there any differences between "made to fit" or "imitation" and Genuine Eureka/Sanitaire paper bags, belts, and parts?

**A:** Yes, there are some very important differences in materials, quality, and reliability. Many customers have mistakenly purchased "imitation" paper bags and parts while thinking they purchased genuine. Unfortunately, many of these customers discovered the differences after they experienced related difficulties.

**For Genuine Sanitaire Value, Accept No Imitations!**



**ELECTROLUX HOME CARE PRODUCTS NORTH AMERICA**  
Bloomington, Illinois 61701

## Free Manuals Download Website

<http://myh66.com>

<http://usermanuals.us>

<http://www.somanuals.com>

<http://www.4manuals.cc>

<http://www.manual-lib.com>

<http://www.404manual.com>

<http://www.luxmanual.com>

<http://aubethermostatmanual.com>

Golf course search by state

<http://golfingnear.com>

Email search by domain

<http://emailbydomain.com>

Auto manuals search

<http://auto.somanuals.com>

TV manuals search

<http://tv.somanuals.com>