



SANUS SYSTEMS

THE UNION OF FORM AND FUNCTION

Assembly Instructions for VisionMount™ LCD Wall Mount Model: VM3

Thank you for choosing Sanus Systems Vision Mount furniture. This product is designed to mount VESA 75/100 compatible LCD televisions up to 30 pounds onto a vertical wall. It allows you to effortlessly tilt and swivel your new television up to 15° in either direction as well as extend it up to 12" away from the wall without the use of tools. Check carefully to make sure there are no missing or defective parts. Never use defective parts. Improper installation may cause damage or serious injury. If you do not understand these directions, or have any doubts about the safety of the installation, please call a qualified contractor or contact Sanus at 800.359.5520 or www.sanus.com. We can quickly assist you with installation questions and missing or damaged parts. Replacement parts for Sanus products purchased through authorized dealers will be shipped directly to you.

Required Tools: Drill with 3/16" bit, Phillips screw driver



(2) Wall Mount Screws - a



(1) Allen Key - b

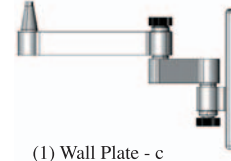

(1) Wall Plate - c

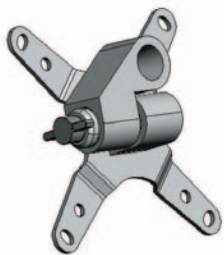

(1) Monitor Mount - d



(4) M4 Bolt - e



(4) M5 Bolt - f



(4) Knob Replacement Bolt - g



(1) Large Washer - h



(1) Cap - i



(1) Small Washer - j

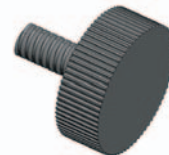

(1) Knob - k

1] Attaching to the Television: Attach the Monitor Mount (d) to the back of your LCD television using the proper bolts as shown in Diagram 1. Place 4 bolts through the Monitor Mount and tighten snugly into the VESA bolt mounting pattern on the back of the television. Make sure the large side of the tapered hole on the Monitor Mount faces toward the bottom of the television. M4 (e) and M5 (f) bolts are provided. Other sizes are available at your local hardware store.

2] Attaching to the Wall: Hardware for **wood stud** mounting is provided. For all other mounting applications contact a specialist. Use a high quality stud sensor to locate a stud. It is a good idea to verify the stud location with an awl or thin nail as shown in Diagram 2A. Use the Wall Plate as a template to mark the two hole locations on the wall. Make sure these holes are aligned vertically and centered over the stud. Pre-drill the two holes using a 3/16" drill bit. Attach the Wall Plate to the wall using the two Wall Mount Screws (a) as shown in Diagram 2B. Tighten the Wall Mount Screws with the Allen Key (b) until they are snug.

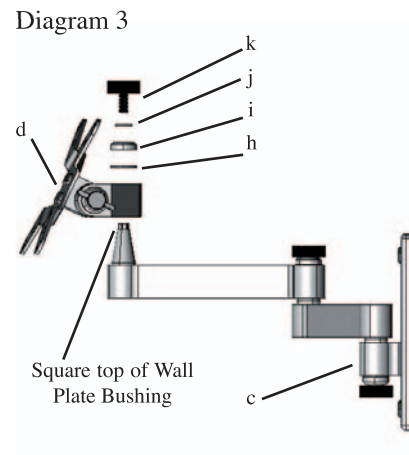
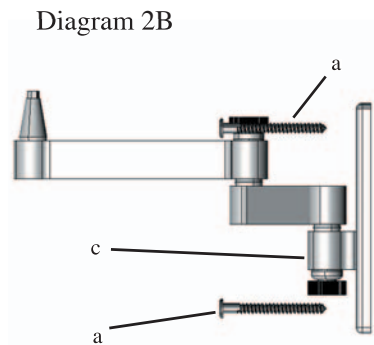
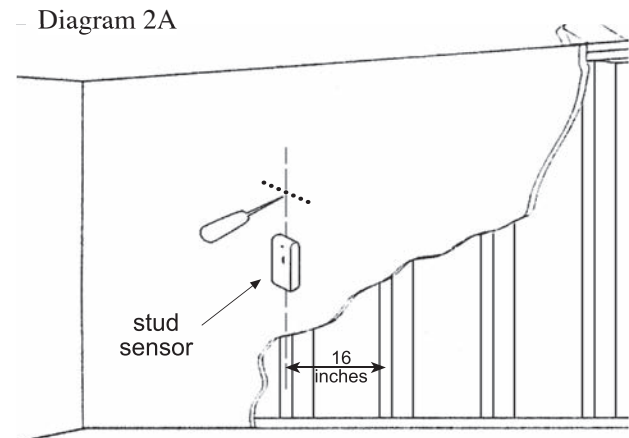
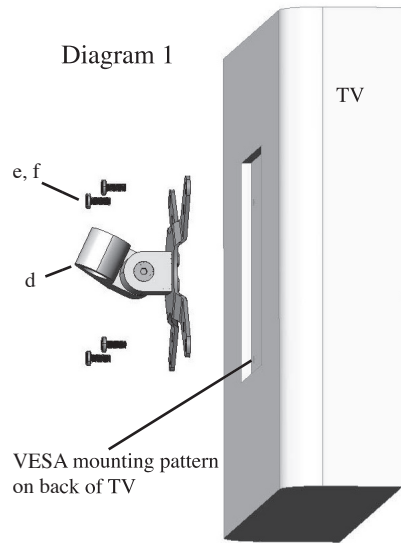

3] Final Assembly: Once the LCD TV is attached to the Monitor Mount (d), and the Wall Plate (c) is properly installed, set the tapered hole in the Monitor Mount down over the cone shaped bushing on the Wall plate. This process is shown without the TV in Diagram 3 so that you can see the parts more clearly. Make sure the Monitor Mount is seated completely onto the Wall Plate. Add the Large Washer (h). Next add the Cap (i). Make sure the square cut into the cap fits over the square top of the Wall Plate bushing. Finally place the Knob (k) through the Small Washer (j) and down through the cap into the Wall Plate bushing. You can now set each of the knobs to the desired level of tension. For institutional or heavy load applications a Knob Replacement bolt (g) may be used in place of each Knob and tightened with the Allen Key provided.

Free Manuals Download Website

<http://myh66.com>

<http://usermanuals.us>

<http://www.somanuals.com>

<http://www.4manuals.cc>

<http://www.manual-lib.com>

<http://www.404manual.com>

<http://www.luxmanual.com>

<http://aubethermostatmanual.com>

Golf course search by state

<http://golfingnear.com>

Email search by domain

<http://emailbydomain.com>

Auto manuals search

<http://auto.somanuals.com>

TV manuals search

<http://tv.somanuals.com>