

SANUS®

Assembly Instructions for Model: AFV48

Thank you for choosing the Sanus AFV48. If you do not understand these directions, or have any doubts about the safety of the installation, please contact Sanus at 800.359.5520 or www.sanus.com. Check carefully to make sure that there are no missing or defective parts. Our customer service representatives can quickly assist you with installation questions and missing or damaged parts. Replacement parts for products purchased through authorized dealers will be shipped directly to you. Never use defective parts. Improper installation may cause damage or serious injury. Do not use this product for any purpose that is not explicitly specified by Sanus. Sanus can not be liable for damage or injury caused by incorrect assembly, or incorrect use. Please contact Sanus before returning products to the point of purchase.

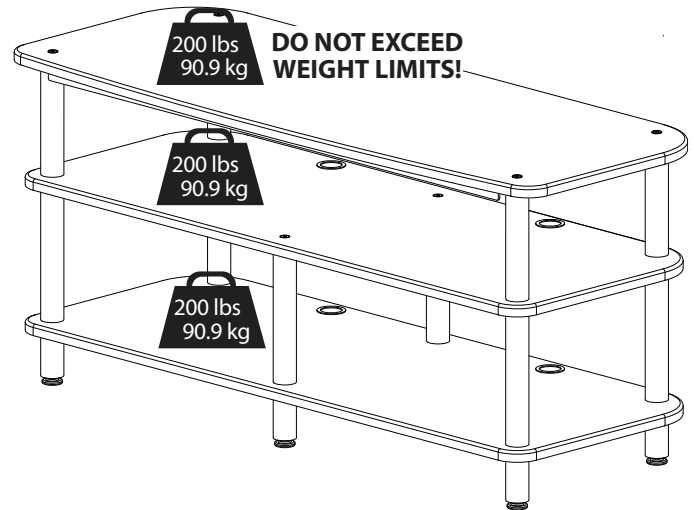

Supplied Parts and Hardware

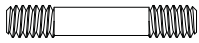

Shelf Connector - A
Qty. 10

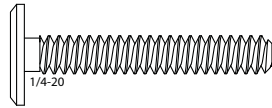

Top Bolt - B
Qty. 6

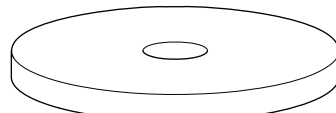

Spacer - C
Qty. 2

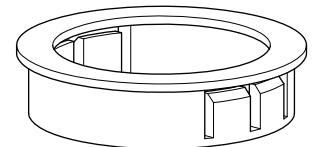

Grommet - D
Qty. 4



3" Pillar - E
Qty. 6



7" Pillar - F
Qty. 4



9" Pillar - G
Qty. 6

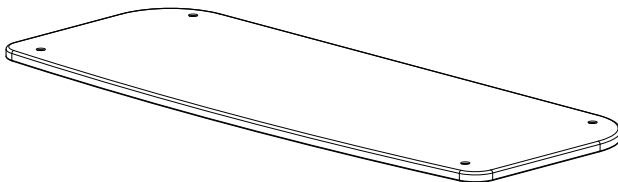

Top Shelf - H
Qty. 1

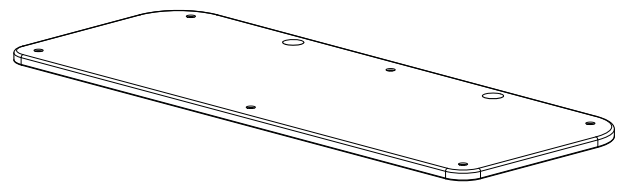

Bottom & Middle Shelf - I
Qty. 2

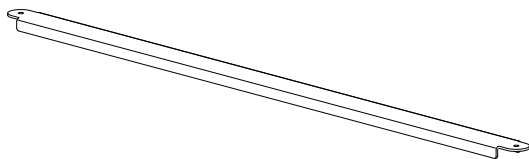

Front Brace - J
Qty. 1

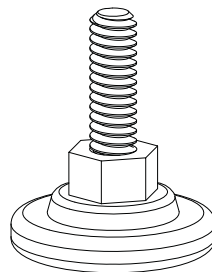

Foot - K
Qty. 6

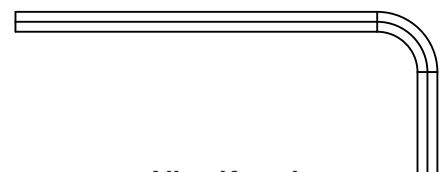

Allen Key - L
Qty. 1

Step 1: Foot Assembly

Thread a Foot (K) into each 3" Pillar (E).

Thread a Shelf Connector (A) into the other end of the 3" Pillar (E) until tight.

Repeat this process for each remaining 3" Pillar.

Diagram 1

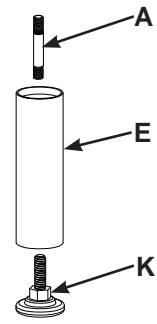

Step 2: Add Bottom Shelf

Insert each Foot Assembly from Step 1 through the Bottom Shelf (I) as shown in Diagram 2.

Diagram 2

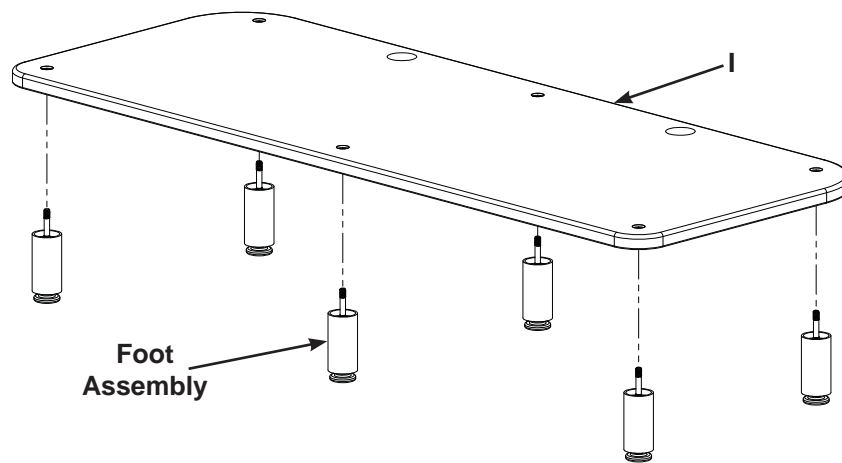

Step 3: Add 9" Pillars

Thread a 9" Pillar (G) onto each exposed Shelf Connector (A) until tight.

Thread a Shelf Connector (A) into the top of the four 9" Pillars (G) as shown in Diagram 3.

Diagram 3

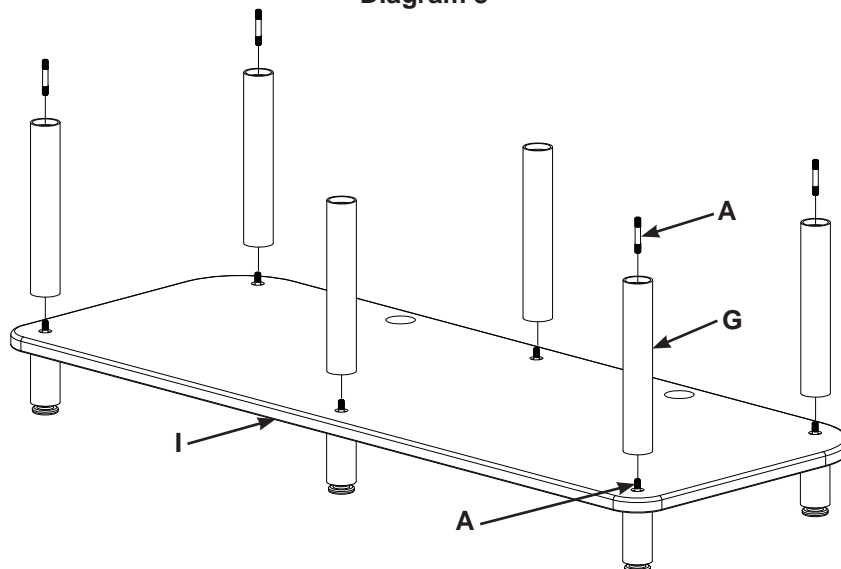

Step 4: Add Middle Shelf

Place the Middle Shelf (I) on the 9" Pillars (G). A Shelf Connector (A) should be protruding above the Middle Shelf at each corner.

Place two Top Bolts (B) through the Middle Shelf (I) and thread them into both middle 9" Pillars (G) as shown in Diagram 4.

Using the Allen Key (L), tighten both Top Bolts (B).

Diagram 4

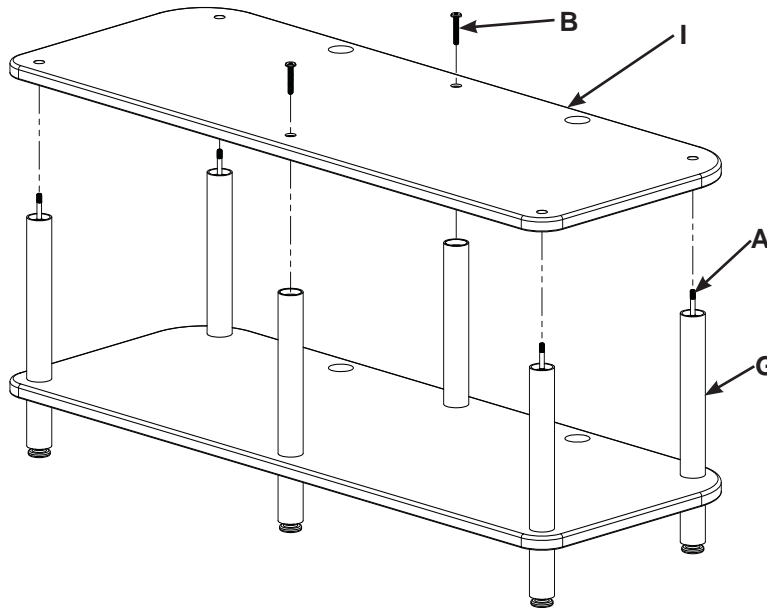

Step 5: Add 7" Pillars

Thread and hand tighten a 7" Pillar (F) onto each exposed Shelf connector (A).

Press a Grommet (D) into each wire management hole in the Bottom and Middle Shelf (I) as shown in Diagram 5.

Diagram 5

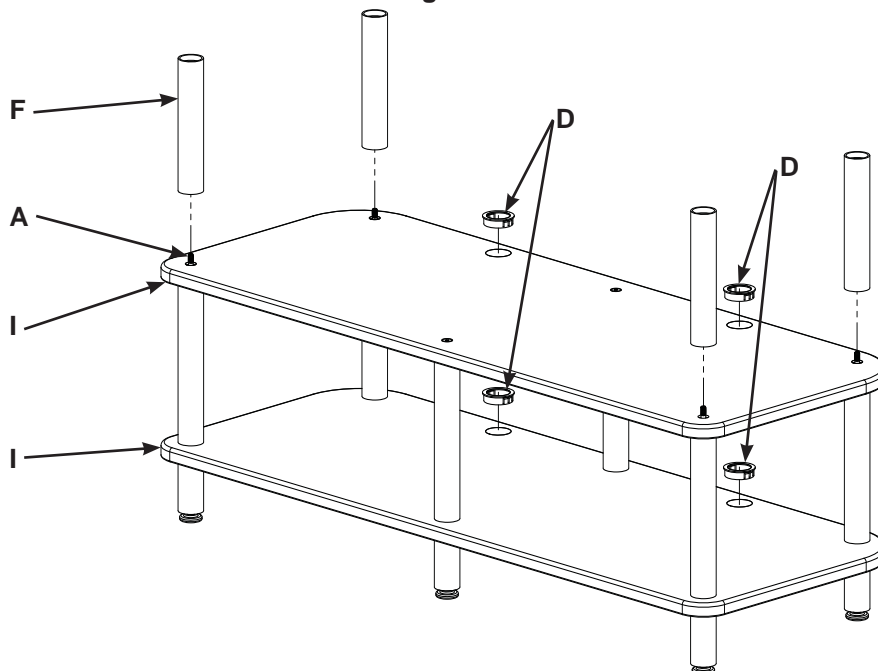

Step 6: Add Top Shelf

Place the Front Brace (J) on the two front 7" Pillars (F) as shown in Diagram 6 and Detail A.

Place the Top Shelf (H) (with its curved edge towards the front) on the Front Brace (J), and 7" Pillars (F) as shown in Diagram 6.

Insert two Top Bolts (B) through the holes in the Top Shelf (H), Front Brace (J) and two front 7" Pillars (F) as shown in Diagram 6 and Detail A.

Place a Spacer (C) on both rear 7" Pillars (F) as shown in Diagram 6 and Detail B.

Insert two Top Bolts (B) through the holes in the Top Shelf (H), two Spacers (C) and two rear 7" Pillars (F) as shown in Diagram 6 and Detail B

Use the Allen Key (L), tighten the four Tops Bolts (B).

Diagram 6

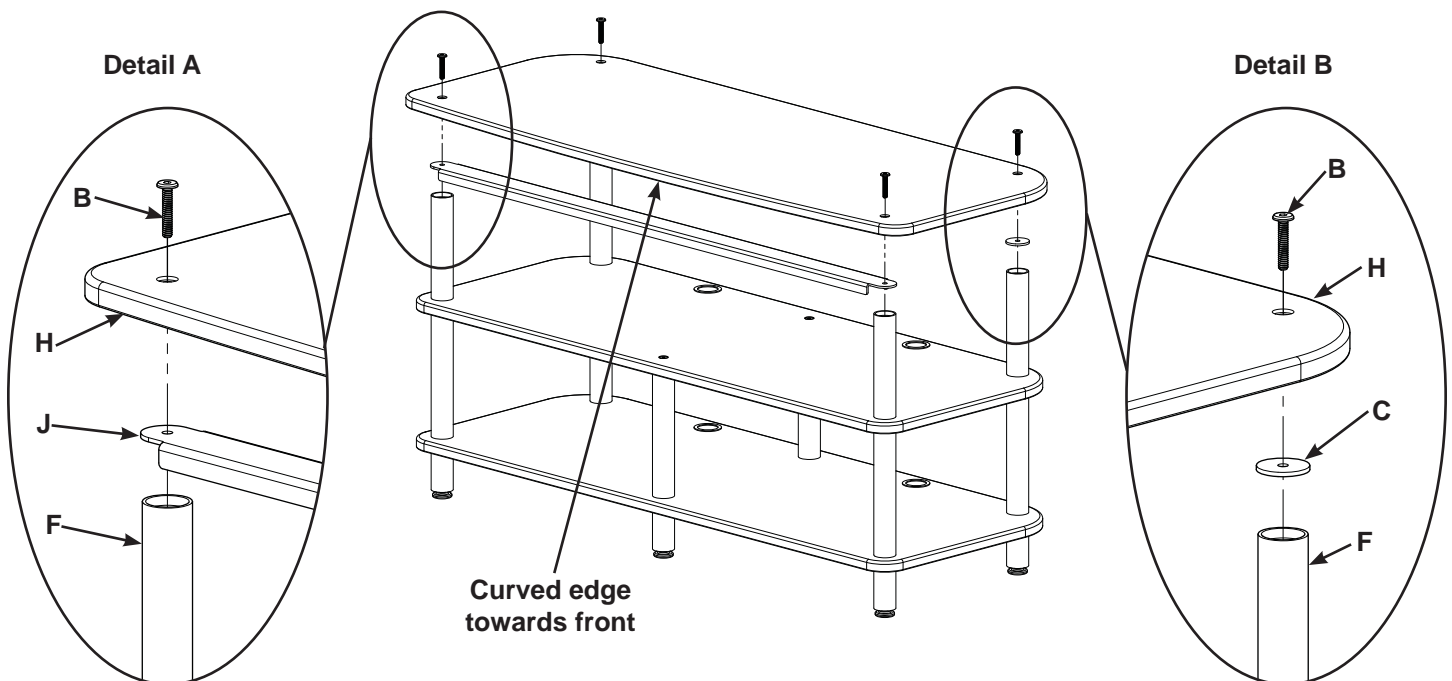

Free Manuals Download Website

<http://myh66.com>

<http://usermanuals.us>

<http://www.somanuals.com>

<http://www.4manuals.cc>

<http://www.manual-lib.com>

<http://www.404manual.com>

<http://www.luxmanual.com>

<http://aubethermostatmanual.com>

Golf course search by state

<http://golfingnear.com>

Email search by domain

<http://emailbydomain.com>

Auto manuals search

<http://auto.somanuals.com>

TV manuals search

<http://tv.somanuals.com>