

Split System Submittal Data



Building Life.

System: 12XS71

Indoor/Outdoor: XS1271/C1271

Grille: PNR-XS1872

Ceiling Recessed Air Conditioner

Job Name: _____
 Location: _____
 Engineer: _____
 Submitted to: _____
 Submitted by: _____
 Reference: _____

Approval: _____
 Date: _____
 Construction: _____
 Unit #: _____
 Drawing #: _____



General Data (at 115V)

Power	V/PH/Hz	115/1/60
Circuit Ampacity	(A)	20
Fuse Size, Max.	(A)	20

Compressor	DC Rotary Inverter	
No. used		1
R.L. Amps - L.R.	(A)	12.6-20

Outdoor Unit		
Fan type		Propeller
Dia. (in.) - No. Speeds		15-3/4-1
Type Drive - No. Speeds		DC Motor
No. Poles	(RPM)	8-750
No. Motors	(W)	50-1
CFM	(HIGH)	1059
F.L. Amps	(A)	0.6

Coil Type		Aluminum Fin and Copper Pipe
Fin Type - Pipe Type		Corrugated Plate-Inner Rifled
Rows - F.P.I.		2-18.1
Face Area	(sq.ft.)	3.95
Tube Size	(in.)	5/16"

Indoor Unit		
Fan type		Turbo
Dia. & Length (in.) - No. Speeds		12-5/8/5-3/4-1
No. Speeds		3+Auto
No. Poles	(RPM, High)	8-470
No. Motors	(W)	30-1
CFM	(Hi/Med/Low)	235/206/194
Indoor Sound Rating	(Hi) (dB-A)	34
F.L. Amps	(A)	.346

Coil Type		Aluminum Plate Fin & Copper Tube
Fin Type - Pipe Type		Slit Plate & Inner Rifled
Rows - F.P.I.		2-18.1
Face Area	(sq.ft.)	2.94
Tube Size	(in.)	9-32"
Drain Connection Size	(in.)	3/32"

Refrigerant		R410A
Lbs. - R410a (outdoor unit)		2.43
Control		Electric Expansion Valve
Connection		Flare
Line Length, Max (ft.)		65
Lift Difference, Max (ft.)		23
Line Size	(in O.D. Discharge)	1/4"
Line Size	(in O.D. Suction)	3/8"

Dimensions	(in.)	H x W x D
Indoor Unit	(uncrated)	11-1/16 x 22-5/8 x 22-5/8
	(crated)	11-13/32 x 24-13/16 x 28-1/8
Outdoor Unit	(uncrated)	21-9/16 x 28-11/32 x 10-1/16
	(crated)	23-5/8 x 33-11/16 x 14-1/4

Weight	Indoor	Outdoor
Net	(lbs.) 35.3	77.2
Shipping	(lbs.) 41.9	83.8

Shipping Volume	(cu.ft.) 4.59	6.35
-----------------	---------------	------

Performance Data @ ARI Standard Conditions (115V)

Cooling		
Total Capacity	(BTU/H)	11,900 (3,000-11,900)
Sensible Capacity	(BTU/H)	7,200
Latent Capacity	(BTU/H)	4,700
SEER		16
Dehumidification	(Pints/H)	4.26
Amps	(A)	12.6 (2.5-12.6)
Power Inputs	(W)	1260 (250-1260)
Outdoor Sound Rating	(dB-A)	47

Dimensions

Features

Controls	Microprocessor
Remote Controller	LCD Wireless Type, Temp. Sensor Built In
Temperature Control	IC Thermostat
Timer	24 Hr Program; 1HR ON/OFF
Night Setback	Built-In
Air Louver	Manual
	Automatic
Power Failure Automatic Restart	Built-In
Self-Diagnosis	Built-In
Air Filter	Washable, Anti-Mold
Air Clean Apatite Filter	Standard
Quiet Operation	Built-In
Ion Generator	Built-In

Options

Refrigerant Line Set	Available
Fresh Air Intake	Knock-out
Airduct Extension	N/A
Condensate Drain Pump	Standard
Hard Wired Remote Controller	Available
Non-Removeable Locking Remo-con Bracket	Available

Operating Range

		Indoor Air Intake Temp.	Outdoor Air Intake Temp.
Cooling	Maximum	95F DB/71F WB	115F DB
	Minimum	67F DB/57F WB	50F DB

- ① Air intake
- ② Discharge outlet
- ③ Refrigerant tubing (liquid tube) dia. 1/4" (flared)
- ④ Refrigerant tubing (gas tube) dia. 1/2" (flared)
- ⑤ Drain tube connection port VP20 (outer dia. 1")
- ⑥ Power supply port
- ⑦ Suspension bolt hole (4 - 1/2" x 1-1/8" hole)
- ⑧ Fresh air intake duct connection port (dia. 3-7/8")

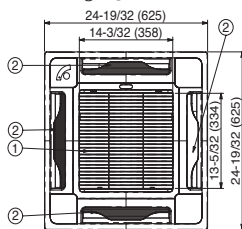
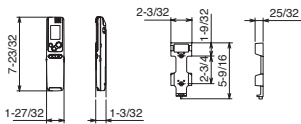
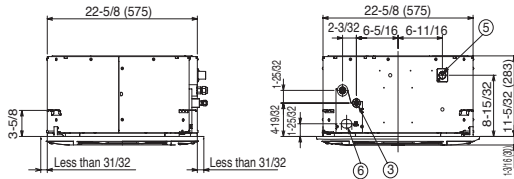
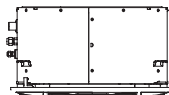
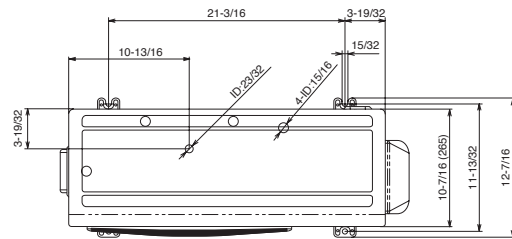
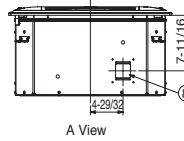
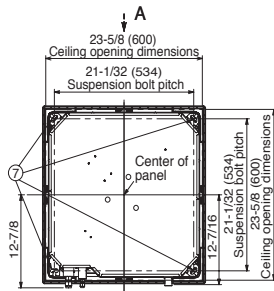

The length of the suspension bolts should be selected so that there is a gap of 1-3/16" or the ceiling (21/32" or more below the lower surface of the main unit), as shown in the figure at right. If the suspension bolts is too long, it will contact the ceiling panel and the unit cannot be installed.

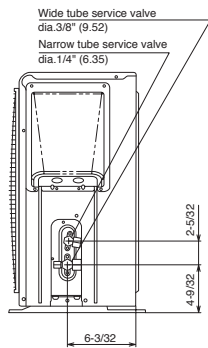
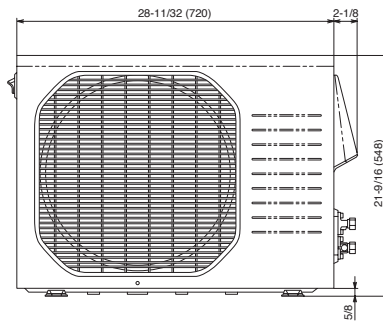
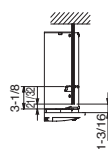

SANYO

Sanyo Commercial Solutions
A Division of SANYO North America
1300 Michael Drive
Wood Dale, IL 60191 USA
www.sanyohvac.com

Free Manuals Download Website

<http://myh66.com>

<http://usermanuals.us>

<http://www.somanuals.com>

<http://www.4manuals.cc>

<http://www.manual-lib.com>

<http://www.404manual.com>

<http://www.luxmanual.com>

<http://aubethermostatmanual.com>

Golf course search by state

<http://golfingnear.com>

Email search by domain

<http://emailbydomain.com>

Auto manuals search

<http://auto.somanuals.com>

TV manuals search

<http://tv.somanuals.com>