

# SANYO INSTALLATION INSTRUCTIONS

## – Inverter Split System Air Conditioner – COOL/DRY/HEAT Model

This air conditioner uses the new refrigerant R410A.

<b>Contents</b>	<b>Page</b>
<b>IMPORTANT!</b> <b>Please Read Before Starting</b> .....	<b>2</b>
<b>1. GENERAL</b> .....	<b>3</b>
1-1. Tools Required for Installation (not supplied)	
1-2. Accessories Supplied with Unit	
1-3. Optional Copper Tubing Kit	
1-4. Type of Copper Tube and Insulation Material	
1-5. Additional Materials Required for Installation	
<b>2. INSTALLATION SITE SELECTION</b> .....	<b>4</b>
2-1. Indoor Unit	
2-2. Outdoor Unit	
<b>3. HOW TO INSTALL THE INDOOR UNIT</b> .....	<b>6</b>
3-1. Remove the Rear Panel from the Unit	
3-2. Make a Hole	
3-3. Install the Rear Panel on the Wall	
3-4. Remove the Grille to Install the Indoor Unit	
3-5. Shape the Indoor Side Tubing	
3-6. Wiring Instructions	
3-7. Recommended Wire Length and Diameter	
3-8. Wiring Instructions for Inter-unit Connections	
3-9. Mounting	
3-10. Drain Hose	
<b>4. HOW TO INSTALL THE OUTDOOR UNIT</b> .....	<b>16</b>
4-1. Wiring Instructions for the Outdoor Unit	
<b>5. REFRIGERANT TUBING</b> .....	<b>17</b>
5-1. Use of the Flaring Method	
5-2. Flaring Procedure with a Flare Tool	
5-3. Caution before Connecting Tubes Tightly	
5-4. Connecting Tubing between Indoor and Outdoor Units	
5-5. Insulation of Refrigerant Tubing	
5-6. Taping the Tubes	
5-7. Finishing the Installation	
<b>6. AIR PURGING</b> .....	<b>19</b>
■ Air Purging with a Vacuum Pump (for Test Run)	
■ Basic Functions of the Service Valves	
■ Pump Down	

<b>Model Combinations</b>	
Combine indoor and outdoor units only as listed below.	
<u>Indoor Unit</u>	<u>Outdoor Unit</u>
KHS0971 _____	CH0971
KHS1271 _____	CH1271
Power Source: 60 Hz, single-phase, 115 V	

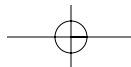
**Be sure to read the yellow instruction sheet attached to the outdoor unit for models using the new refrigerant R410A.**

<b>7. REMOTE CONTROL UNIT INSTALLATION POSITION</b> .....	<b>23</b>
7-1. Mounting on a Wall	
<b>8. ADDRESS SWITCH</b> .....	<b>24</b>
8-1. Address Setting of the Remote Control Unit	

**NOTE**

The illustrations are based on the typical appearance of a standard model. Consequently, the shape may differ from that of the air conditioner that you are installing.

85264189990003 © SANYO 2006	<b>SANYO FISHER COMPANY</b> A DIVISION OF SANYO NORTH AMERICA CORPORATION 21605 Plummer Street Chatsworth, CA 91311 U.S.A.	In Canada <b>SANYO Canada Inc.</b> 300 Applewood Crescent, Concord Ontario, L4K 5C7, Canada
-----------------------------	---	--



## IMPORTANT! Please Read Before Starting

This air conditioning system meets strict safety and operating standards. As the installer or service person, it is an important part of your job to install or service the system so it operates safely and efficiently.

### For safe installation and trouble-free operation, you must:

- Carefully read this instruction booklet before beginning.
- Follow each installation or repair step exactly as shown.
- Observe all local, state, and national electrical codes.
- Pay close attention to all warning and caution notices given in this manual.



#### WARNING

This symbol refers to a hazard or unsafe practice which can result in severe personal injury or death.



#### CAUTION

This symbol refers to a hazard or unsafe practice which can result in personal injury or product or property damage.

### If Necessary, Get Help

These instructions are all you need for most installation sites and maintenance conditions. If you require help for a special problem, contact our sales/service outlet or your certified dealer for additional instructions.

### In Case of Improper Installation

The manufacturer shall in no way be responsible for improper installation or maintenance service, including failure to follow the instructions in this document.

## SPECIAL PRECAUTIONS

#### WARNING

### When Wiring



**ELECTRICAL SHOCK CAN CAUSE SEVERE PERSONAL INJURY OR DEATH. ONLY A QUALIFIED, EXPERIENCED ELECTRICIAN SHOULD ATTEMPT TO WIRE THIS SYSTEM.**

- Do not supply power to the unit until all wiring and tubing are completed or reconnected and checked.
- Highly dangerous electrical voltages are used in this system. Carefully refer to the wiring diagram and these instructions when wiring. Improper connections and inadequate grounding can cause **accidental injury or death**.
- **Ground the unit** following local electrical codes.
- Connect all wiring tightly. Loose wiring may cause overheating at connection points and a possible fire hazard.

### When Transporting

Be careful when picking up and moving the indoor and outdoor units. Get a partner to help, and bend your knees when lifting to reduce strain on your back. Sharp edges or thin aluminum fins on the air conditioner can cut your fingers.

### When Installing...

#### ...In a Ceiling or Wall

Make sure the ceiling/wall is strong enough to hold the unit's weight. It may be necessary to construct a strong wood or metal frame to provide added support.

#### ...In a Room

Properly insulate any tubing run inside a room to prevent "sweating" that can cause dripping and water damage to walls and floors.

#### ...In Moist or Uneven Locations

Use a raised concrete pad or concrete blocks to provide a solid, level foundation for the outdoor unit. This prevents water damage and abnormal vibration.

#### ...In an Area with High Winds

Securely anchor the outdoor unit down with bolts and a metal frame. Provide a suitable air baffle.

#### ...In a Snowy Area (for Heat Pump-type Systems)

Install the outdoor unit on a raised platform that is higher than drifting snow. Provide snow vents.

### When Connecting Refrigerant Tubing

- Use the flare method for connecting tubing.
- Apply refrigerant lubricant to the matching surfaces of the flare and union tubes before connecting them, then tighten the nut with a torque wrench for a leak-free connection.
- Check carefully for leaks before starting the test run.

### When Servicing

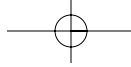
- Turn the power OFF at the main power box (mains) before opening the unit to check or repair electrical parts and wiring.
- Keep your fingers and clothing away from any moving parts.
- Clean up the site after you finish, remembering to check that no metal scraps or bits of wiring have been left inside the unit being serviced.

### Others



#### CAUTION

- Ventilate any enclosed areas when installing or testing the refrigeration system. Escaped refrigerant gas, on contact with fire or heat, can produce dangerously toxic gas.
- Confirm upon completing installation that no refrigerant gas is leaking. If escaped gas comes in contact with a stove, gas water heater, electric room heater or other heat source, it can produce dangerously toxic gas.



## 1. General

This booklet briefly outlines where and how to install the air conditioning system. Please read over the entire set of instructions for the indoor and outdoor units and make sure all accessory parts listed are with the system before beginning.






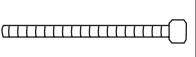
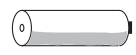

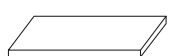

### 1-1. Tools Required for Installation (not supplied)

1. Standard screwdriver
2. Phillips head screwdriver
3. Knife or wire stripper
4. Tape measure
5. Carpenter's level

6. Sabre saw or key hole saw
7. Hacksaw
8. Core bits
9. Hammer
10. Drill
11. Tube cutter
12. Tube flaring tool
13. Torque wrench
14. Adjustable wrench
15. Reamer (for deburring)

### 1-2. Accessories Supplied with Unit

Table 1

Parts	Figure	Q'ty	Parts	Figure	Q'ty	Parts	Figure	Q'ty
Remote control unit		1	Tapping screw	 Truss-head Phillips 5/32 x 5/8" (4x16 mm)	10	Hex wrench*		1
Remote control unit holder		1	Rawl plug		8	Clamp		1
AAA alkaline battery		2	Drain hose adapter		1	*Packed in the outdoor unit.		
Air clean filter		2	Cushion rubber*		4			

### 1-3. Optional Copper Tubing Kit

Copper tubing for connecting the outdoor unit to the indoor unit is available in kits which contain the narrow and wide tubing, fittings and insulation. Consult your nearest sales outlet or A/C workshop.

### 1-4. Type of Copper Tube and Insulation Material

If you wish to purchase these materials separately from a local source, you will need:

1. Deoxidized annealed copper tube for refrigerant tubing as detailed in Table 2.  
Cut each tube to the appropriate lengths 1' to 1'4" (30 cm to 40 cm) to dampen vibration between units.

2. Foamed polyethylene insulation for the specified copper tubes as required to precise length of tubing. Wall thickness of the insulation should be not less than 5/16" (8 mm).
3. Use insulated copper wire for field wiring. Wire size varies with the total length of wiring. Refer to 3-6. Wiring Instructions for details.

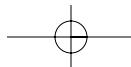


**CAUTION**

**Check local electrical codes and regulations before obtaining wire. Also, check any specified instructions or limitations.**

Table 2

Model	Narrow Tube		Wide Tube	
	Outer Dia.	Thickness	Outer Dia.	Thickness
KHS0971/1271	1/4" (6.35 mm)	0.0314" (0.8 mm)	3/8" (9.52 mm)	0.0314" (0.8 mm)



**1-5. Additional Materials Required for Installation**

1. Refrigeration (armored) tape
2. Insulated staples or clamps for connecting wire  
(See local codes)
3. Putty
4. Refrigeration lubricant
5. Clamps or saddles to secure refrigerant tubing

**2. Installation Site Selection**

**2-1. Indoor Unit**



**WARNING**

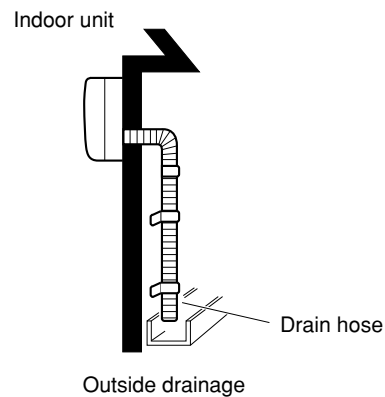
To prevent abnormal heat generation and the possibility of fire, do not place obstacles, enclosures and grilles in front of or surrounding the air conditioner in a way that may block air flow.

**AVOID:**

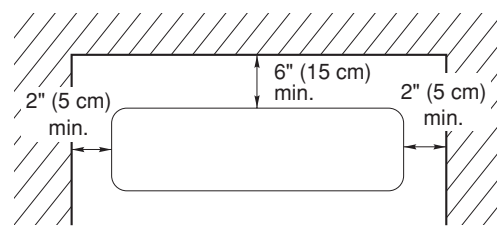
- direct sunlight.
- nearby heat sources that may affect performance of the unit.
- areas where leakage of flammable gas may be expected.
- places where large amounts of oil mist exist.

**DO:**

- select an appropriate position from which every corner of the room can be uniformly cooled. (High on a wall is best.)
- select a location that will hold the weight of the unit.
- select a location where tubing and drain hose have the shortest run to the outside. (Fig. 1)
- allow room for operation and maintenance as well as unrestricted air flow around the unit. (Fig. 2)
- install the unit within the maximum elevation difference (H) above or below the outdoor unit and within a total tubing length (L) from the outdoor unit as detailed in Table 3 and Fig. 3a.
- Install the indoor unit more than 3.3' (1 m) away from any antenna or power lines or connecting wires used for television, radio, telephone, security system, or intercom. Electrical noise from any of these sources may affect operation.

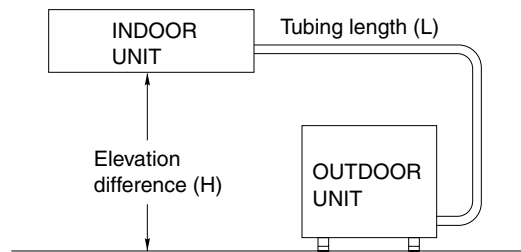


**Fig. 1**



**Front View**

**Fig. 2**

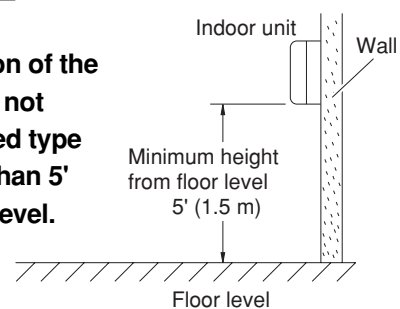


**Fig. 3a**



**CAUTION**

For stable operation of the air conditioner, do not install wall-mounted type indoor units less than 5' (1.5 m) from floor level.

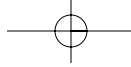


**Fig. 3b**

**Table 3**

Model	Max. Allowable Tubing Length at Shipment (ft.)	Limit of Tubing Length (L) (ft.)	Limit of Elevation Difference (H) (ft.)	Required Amount of Additional Refrigerant (oz./ft.)*
KHS0971	25	50	23	0.16
KHS1271	25	65	23	0.16

\* If total tubing length becomes 25 ft. (max.), charge additional refrigerant (R410A) by 0.16 oz./ft. No additional charge of compressor oil is necessary.



## 2-2. Outdoor Unit

### AVOID:

- heat sources, exhaust fans, etc. (Fig. 4)
- damp, humid or uneven locations.

### DO:

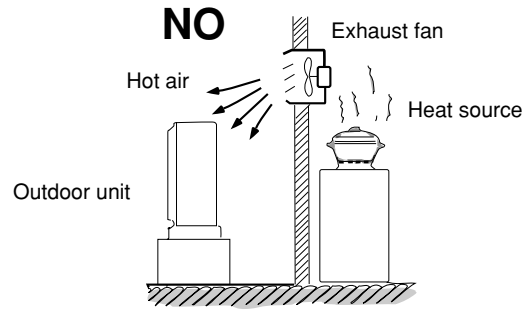
- choose a place as cool as possible.
- choose a place that is well ventilated.
- allow enough room around the unit for air intake/exhaust and possible maintenance. (Fig. 5a)
- provide a solid base (level concrete pad, concrete block, 4" x 1'4" (10 x 40 cm) beams or equal), a minimum of 4" (10 cm) above ground level to reduce humidity and protect the unit against possible water damage and decreased service life. (Figs. 5b and 5c)



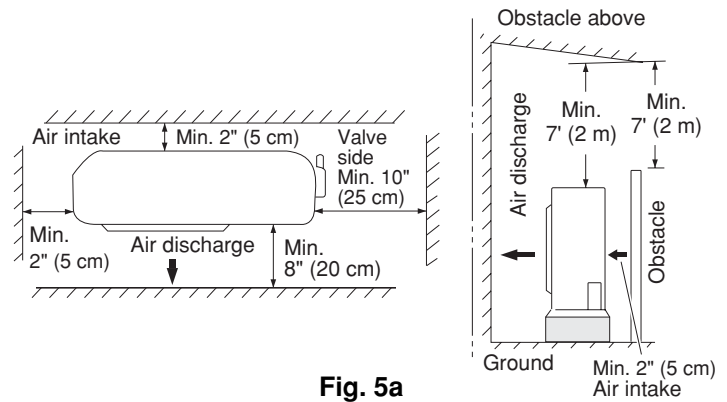
**CAUTION**

**A solid base must not cover the hole of the bottom plate.**

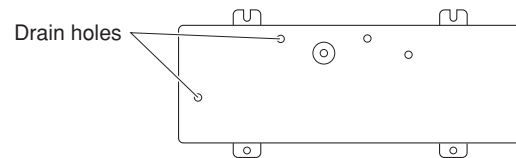
- Install cushion rubber under unit's feet to reduce vibration and noise. (Fig. 5d)
- use lug bolts or equal to bolt down unit, reducing vibration and noise.
- Install in a location where no antenna of a television or radio exists within 10' (3 m).



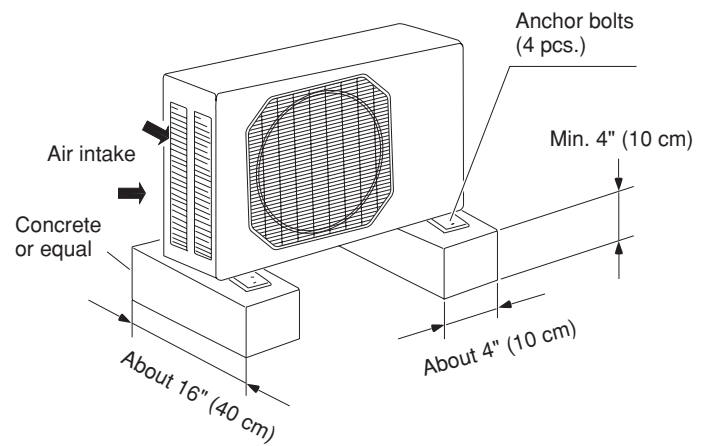
**Fig. 4**



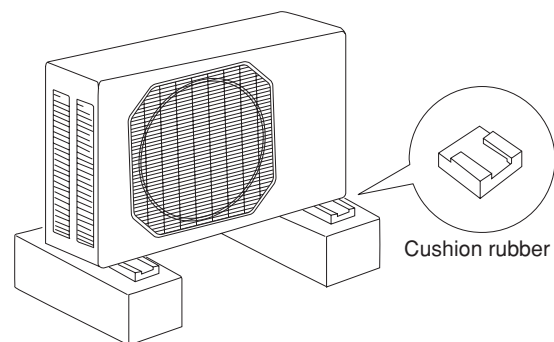
**Fig. 5a**



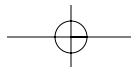
**Fig. 5b**



**Fig. 5c**



**Fig. 5d**



### 3. How to Install the Indoor Unit

#### 3-1. Remove the Rear Panel from the Unit

- (1) Remove and discard the set screw on the rear panel. (Fig. 6)
- (2) Press the 2  $\Delta$  marks on the frame cover and disengage the stationary tabs from the frame. (Fig. 7)
- (3) Remove the rear panel.

#### NOTE

Tubing can be extended in 5 directions as shown in Fig. 8. Select the direction you need providing the shortest run to the outside unit.

- When left tubing is to be done, switch the drain hose and drain cap. (For details, refer to "Switching drain hose and drain cap" on page 14.)

#### 3-2. Make a Hole

- (1) Place the rear panel from the indoor unit on the wall at the location selected. Make sure the panel is horizontal, using a carpenter's level or tape measure to measure down from the ceiling. Wait until after cutting the hole before attaching the rear panel to the wall.
- (2) Determine which side of the unit you should make the hole for tubing and wiring. (Fig. 9)

#### NOTE

In the case of left-rear tubing, use the measurement points 2-3/4" (70 mm) from the edge of the rear panel for precise placement of the hose outlet. (Fig. 9)

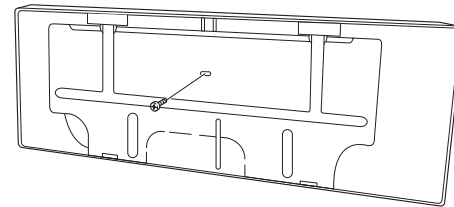
- (3) Before making the hole, check carefully that no studs or pipes are directly run behind the spot to be cut.



**CAUTION**

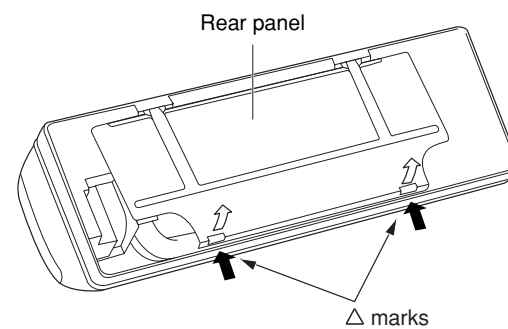
**Also avoid areas where electrical wiring or conduits are located.**

The above precautions are also applicable if tubing goes through the wall in any other location.

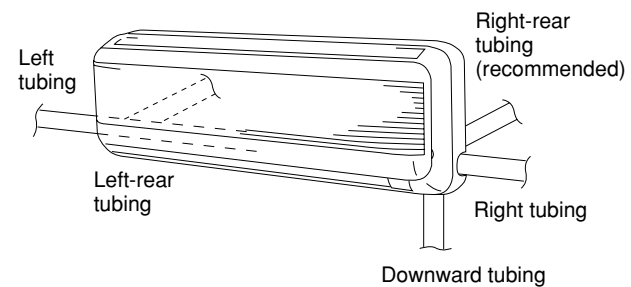


Set screw only for transportation

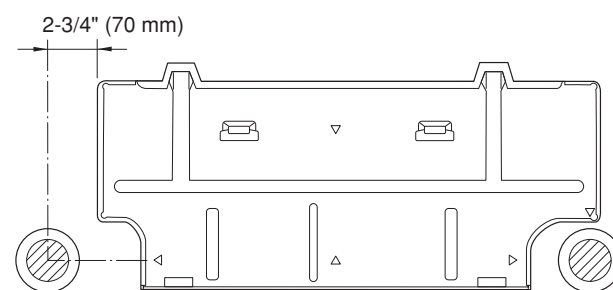
**Fig. 6**



**Fig. 7**



**Fig. 8**



**Fig. 9**

- (4) Using a sabre saw, key hole saw or hole-cutting drill attachment, cut a hole in the wall. See Table 4 and Fig. 10.

**Table 4**

Hole Dia.
2-9/16" (65 mm)

- (5) Measure the thickness of the wall from the inside edge to the outside edge and cut PVC pipe at a slight angle 1/4" (6 mm) shorter than the thickness of the wall. (Fig. 11)
- (6) Place the plastic cover over the end of the pipe (for indoor side only) and insert the pipe in the wall. (Fig. 12)

**3-3. Install the Rear Panel on the Wall**

Be sure to confirm that the wall is strong enough to suspend the unit.

See either Item a) or b) below depending on the wall type.

**a) If Wooden Wall**

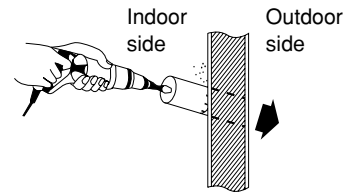
- (1) Attach the rear panel to the wall with the 8 screws provided. (Fig. 13)  
If you are not able to line up the holes in the rear panel with the beam locations marked on the wall, use rawl plugs or toggle bolts to go through the holes on the panel or drill 3/16" (5 mm) dia. holes in the panel over the stud locations and then mount the rear panel.
- (2) Double check with a carpenter's level or tape measure that the panel is level. This is important to install the unit properly. (Fig. 14)
- (3) Make sure the panel is flush against the wall. Any space between the wall and unit will cause noise and vibration.

**b) If Block, Brick, Concrete or Similar Type Wall**

Make 3/16" (4.8 mm) dia. holes in the wall. Insert rawl plugs for appropriate mounting screws. (Fig. 15)

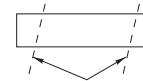
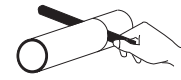
**NOTE**

Hole should be made at a slight downward slant to the outdoor side.



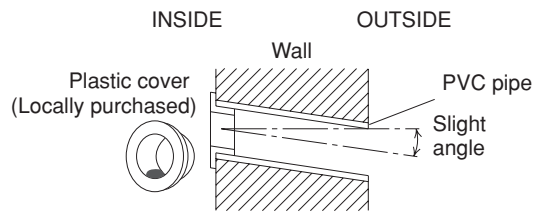
**Fig. 10**

PVC pipe (Locally purchased)

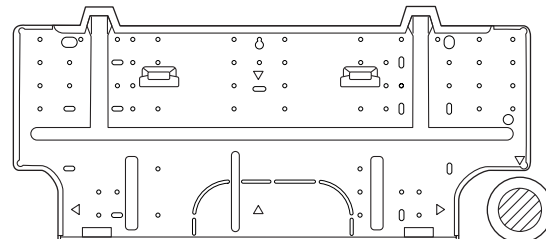


Cut at slight angle

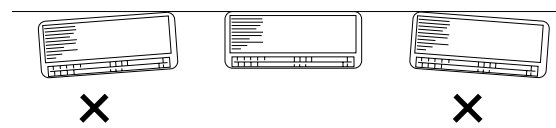
**Fig. 11**



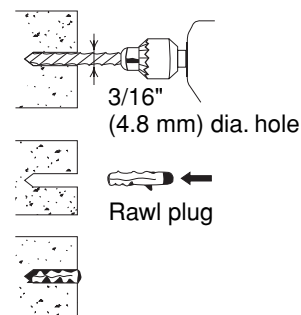
**Fig. 12**



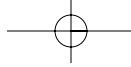
**Fig. 13**



**Fig. 14**



**Fig. 15**



### 3-4. Remove the Grille to Install the Indoor Unit

Basically, these models can be installed and wired without removing the grille. If access to any internal part is needed, follow the steps as given below.



#### CAUTION

Be sure to wear work gloves during installation to avoid being cut by the sharp aluminum fins of the heat exchanger.

#### How to remove the grille

- (1) Grasp both ends of the air intake grille, and remove it by opening towards the front and pulling towards you. (Fig. 16a)
- (2) Remove the 2 screws. (Fig. 16b)
- (3) Remove the screw on the right side cover plate and open the cover. (Fig. 17a)
- (4) Take out the thermistor from the grille. (Fig. 17b)
- (5) Pull the lower part of the grille toward you to remove. (Fig. 18a)
- (6) Use a standard screwdriver to push on the tabs to remove the grille. (Fig. 18b)

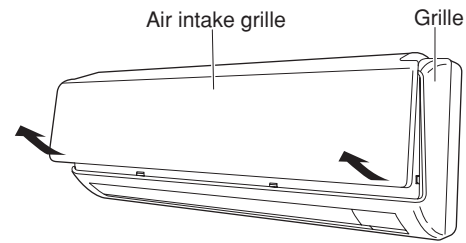


Fig. 16a

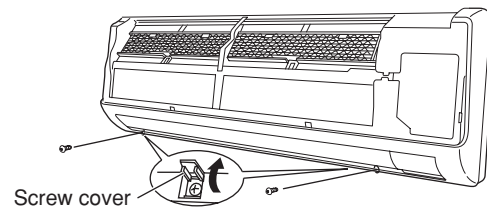


Fig. 16b

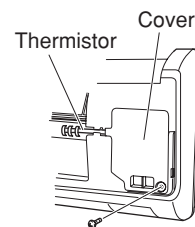


Fig. 17a

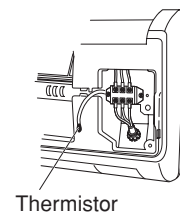


Fig. 17b

#### How to replace the grille

- (1) Reinstall the grille into the lower part while aligning its tabs on the upper part. (Fig. 18b) Insert the tabs in the slots and push the lower part of the grille back into position.
- (2) Make sure that the grille and frame are firmly fitted together by engaging the tabs.
- (3) Attach the thermistor on the grille. (Fig. 17a)
- (4) Close the cover and replace the screw. (Fig. 17a)
- (5) Affix the grille with the 2 previously removed screws. (Fig. 16b)
- (6) Install the air intake grille.
  - (a) Allow the edge of the air intake grille to slide into the top of the indoor unit, and then insert it all the way inside. (Fig. 19a)
  - (b) Press the bottom right and left corners of the air intake grille to attach it to the indoor unit. (Fig. 19b)

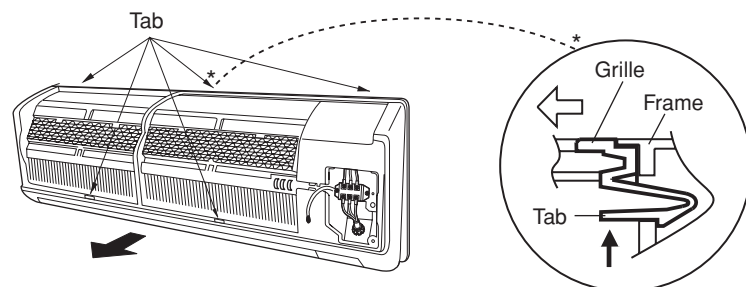


Fig. 18a

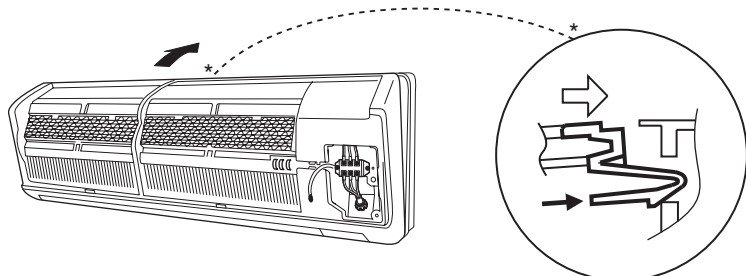


Fig. 18b

#### NOTE

Attach so that the round pins at the top right and left corners of the air intake grille are inserted into the grooves at the top right and left of the indoor unit.

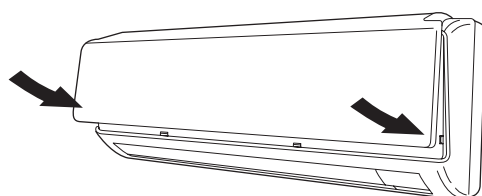


Fig. 19b

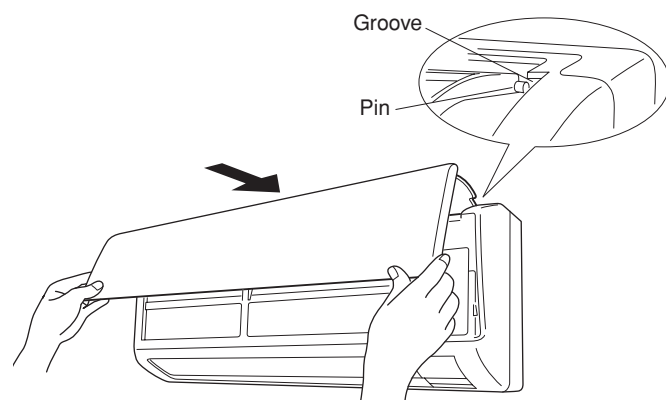
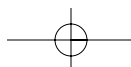


Fig. 19a





### 3-5. Shape the Indoor Side Tubing

#### (1) Arrangement of tubing by direction

##### a) Right or left tubing

Cut out the corner of the right/left frame with a hacksaw or the like. (Figs. 20 and 21)

##### b) Right-rear or left-rear tubing

In this case, the corner of the frame need not be cut.

#### (2) To mount the indoor unit on the rear panel:

Hang the 2 mounting slots of the unit on the upper tabs of the rear panel. (Fig. 22)

### 3-6. Wiring Instructions

#### General precautions on wiring

- (1) Before wiring, confirm the rated voltage of the unit as shown on its nameplate, then carry out the wiring closely following the wiring diagram.
- (2) Provide a power outlet to be used exclusively for each unit, with a power supply disconnect and circuit breaker for overcurrent protection provided in the exclusive line.
- (3) To prevent possible hazards due to insulation failure, the unit must be grounded.
- (4) Each wiring connection must be done tightly and in accordance with the wiring system diagram. Wrong wiring may cause the unit to misoperate or become damaged.
- (5) Do not allow wiring to touch the refrigerant tubing, compressor, or any moving parts of the fan.
- (6) Unauthorized changes in the internal wiring can be very dangerous. The manufacturer will accept no responsibility for any damage or misoperation that occurs as a result of such unauthorized changes.

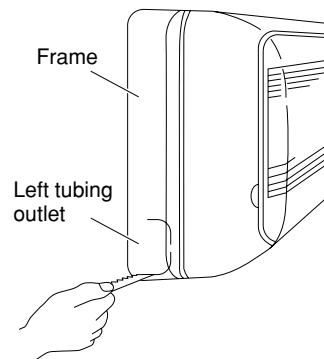


Fig. 20

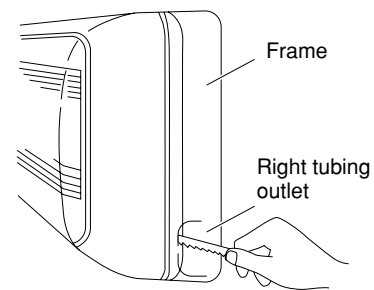


Fig. 21

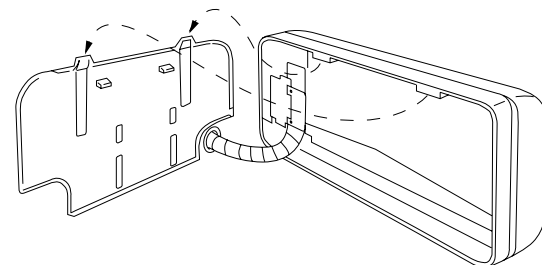
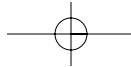


Fig. 22



### 3-7. Recommended Wire Length and Diameter

Regulations on wiring diameter differ from locality to locality. For field wiring requirements, please refer to your local electrical codes. Carefully observe these regulations when carrying out the installation.

Table 5 lists recommended wire lengths and diameters for power supply systems.

**NOTE**

Refer to the wiring system diagram (Fig. 23) for the meaning of (A), (B), and (C) in Table 5.

Refer to your local codes or in the absence of local codes see the National Electric Code: ANSI/NFPA70.

**Table 5**

Model	AWG	(A)+(B)	(A) Power Supply Wiring Length (ft) (B) Power Line Length (ft)	(C) Control Line Length (ft)	Fuse or Circuit Breaker Capacity
		(#14)	(#12)	(#14)	
CH0971, CH1271		131 (Max.)	230 (Max.)	65 (Max.)	20A

# ... AWG (American Wire Gauge)



**WARNING**

- Be sure to comply with local codes on running the wire from the indoor unit to the outdoor unit (size of wire and wiring method, etc.).
- Each wire must be firmly connected.
- No wire should be allowed to touch refrigerant tubing, the compressor, or any moving part.



**WARNING**

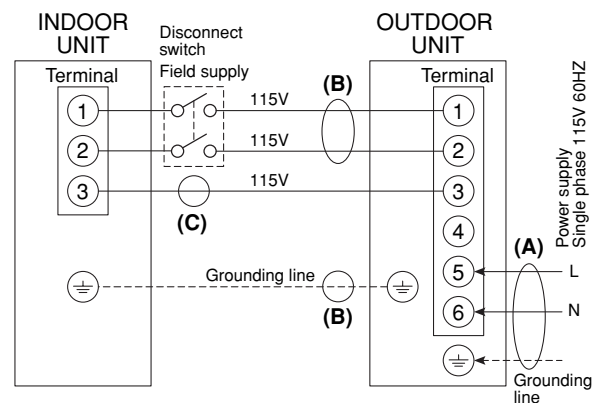
- To avoid the risk of electric shock, each air conditioner unit must be grounded.
- For the installation of a grounding device, please observe local electrical codes.
- Grounding is necessary, especially for units using inverter circuits, in order to release charged electricity and electrical noise caused by high tension. Otherwise, electrical shock may occur.
- Place a dedicated ground more than 7' (2 m) away from other grounds and do not have it shared with other electric appliances.



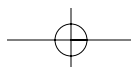
**CAUTION**

- Be sure to connect the power supply line to the outdoor unit as shown in the wiring diagram. The indoor unit draws its power from the outdoor unit.
- Do not run wiring for antenna, signal, or power lines of television, radio, stereo, telephone, security system, or intercom any closer than 3'4" (1 m) from the power cable and wires between the indoor and outdoor units. Electrical noise may affect the operation.

**WIRING SYSTEM DIAGRAM**



**Fig. 23**



### 3-8. Wiring Instructions for Inter-unit Connections

- (1) Insert the inter-unit wiring (according to local codes) into the through-the-wall PVC pipe. Run the wiring toward the indoor side allowing approx. 10" (25 cm) to extend from the wall face. (Fig. 24)
- (2) Grasp both ends of the air intake grille, and remove it by opening towards the front and pulling towards you.
- (3) Remove the screw on the right side cover plate and open the cover. (Fig. 25)
- (4) Route the inter-unit wiring from the back of the indoor unit and pull it toward the front for connection. (Fig. 26a, 26b)
- (5) Connect the inter-unit wiring to the corresponding terminals on the terminal plate (Fig. 26a, 26b) while referring to the wiring diagram.
- (6) Be sure to secure the wiring with the provided clamp.

#### NOTE

When closing the air intake grille, press on both corners. (Fig. 27)

Please refer to "How to replace the grille" on page 8 for installing the air intake grille.

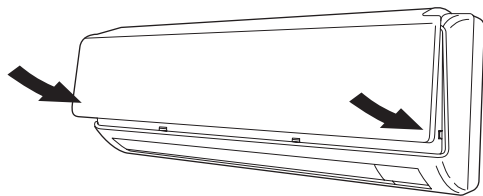


Fig. 27

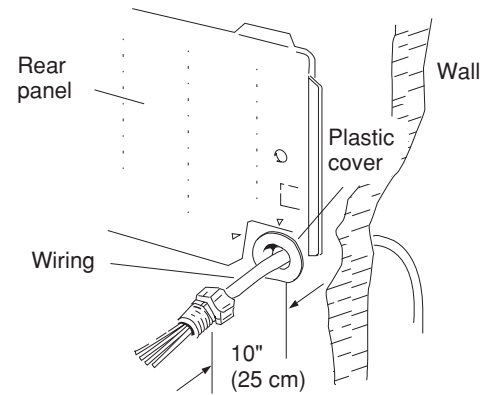


Fig. 24

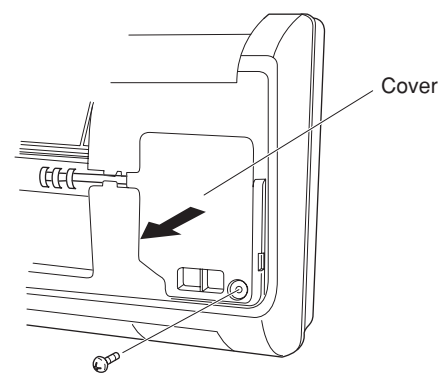


Fig. 25

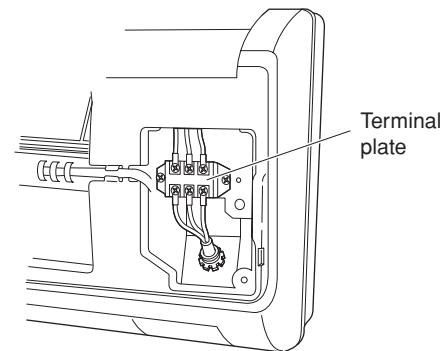


Fig. 26a

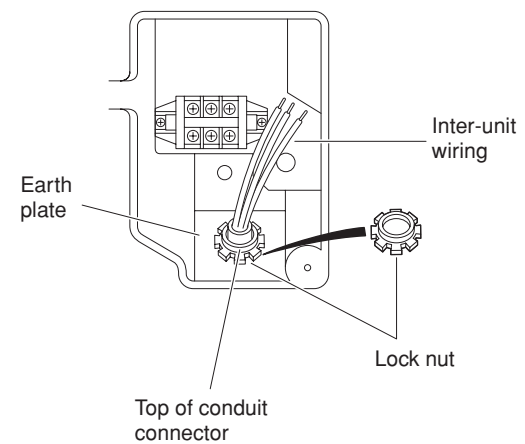


Fig. 26b

**WARNING**

Loose wiring may cause the terminal to overheat or result in unit malfunction. A fire hazard may also exist. Therefore, be sure all wiring is tightly connected.

When connecting each power wire to the corresponding terminal, follow the instructions "How to connect wiring to the terminal" and fasten the wire securely tight with the fixing screw of the terminal plate.

**How to connect wiring to the terminal****a) For Indoor Unit**

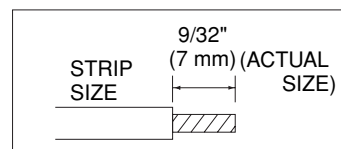
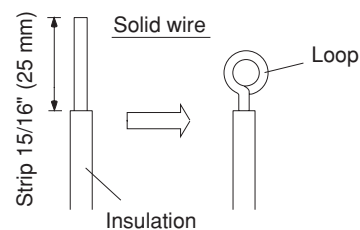
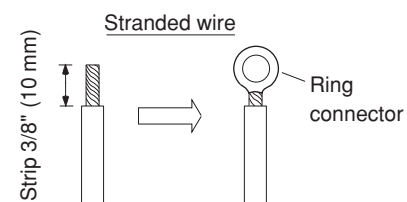
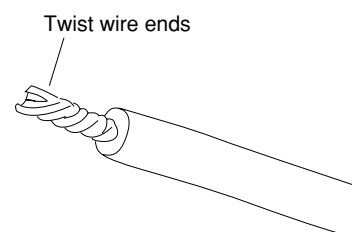
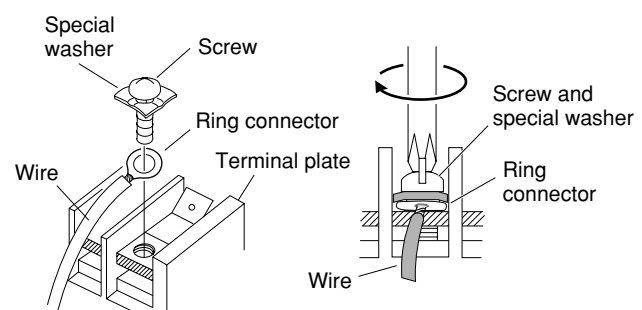
- (1) Cut the wire end with a cutting pliers, then strip the insulation to expose the wire about  $9/32"$  (7 mm). See the label (Fig. 28) near the terminal plate.
- (2) Using a screwdriver, loosen the terminal screw on the terminal plate.
- (3) Insert the wire and tighten the terminal screw completely using a screwdriver.

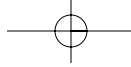
**b) For Outdoor Unit****■ For solid core wiring (or F-cable)**

- (1) Cut the wire end with a cutting pliers, then strip the insulation to expose the solid wire about  $15/16"$  (25 mm). (Fig. 29)
- (2) Using a screwdriver, remove the terminal screw(s) on the terminal plate.
- (3) Using the pliers, bend the solid wire to form a loop suitable for the terminal screw.
- (4) Shape the loop wire properly, place it on the terminal plate and fix it securely with the removed terminal screw using a screwdriver.

**■ For stranded wiring**

- (1) Cut the wire end with a cutting pliers, then strip the insulation to expose the stranded wiring about  $3/8"$  (10 mm) and tightly twist the wire ends. (Figs. 30 and 31)
- (2) Using a screwdriver, remove the terminal screw(s) on the terminal plate.
- (3) Using a ring connector fastener or pliers, securely clamp each stripped wire end with a ring connector. (Fig. 30)
- (4) Place the ring connector wire, and replace and tighten the removed terminal screw using a screwdriver. (Fig. 32)

**Fig. 28****Fig. 29****Fig. 30****Fig. 31****Fig. 32**



### 3-9. Mounting

- (1) To install the indoor unit, mount the indoor unit onto the 2 tabs on the upper part of the rear plate.
- (2) Hold down the air discharge outlet and press the lower part of the indoor unit until it clicks to securely fasten to the 2 tabs on the lower part of the rear plate. (Fig. 33)

#### NOTE

For tubing, choose either the right or left tubing direction and follow the steps below. This work can be made easier by placing padding material (such as styrofoam) at the rear right side of the indoor unit. (Fig. 34)

#### ■ Right-side tubing

- (1) Shape the refrigerant tubing so that it can easily go into the wall hole. (Fig. 35)
- (2) Push the wiring, refrigerant tubing, and drain hose through the hole in the wall. Adjust the indoor unit so it is securely seated on the rear panel. (Fig. 36)
- (3) Carefully bend the tubing (if necessary) to run along the wall in the direction of the outdoor unit and then tape as far as the fittings. (See Caution on page 18.) The drain hose should come straight down the wall to a point where water runoff won't stain the wall.
- (4) Connect the refrigerant tubing to the outdoor unit. (After performing a leak test on the connecting part, insulate it with the tubing insulation. (Fig. 37a)) Also, refer to Section 5-4. Connecting Tubing between Indoor and Outdoor Units.
- (5) Assemble the refrigerant tubing, drain hose, and conduit (including inter-unit wiring) as shown in Fig. 37b.

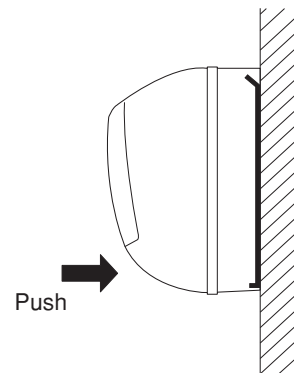


Fig. 33

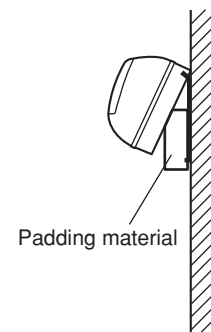


Fig. 34

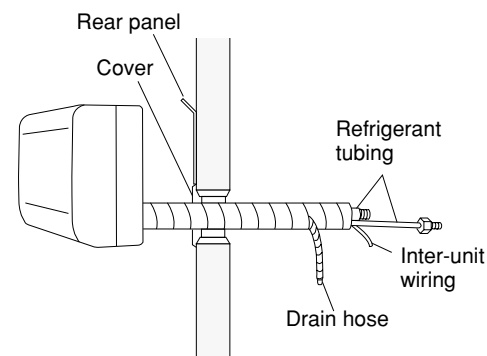


Fig. 35

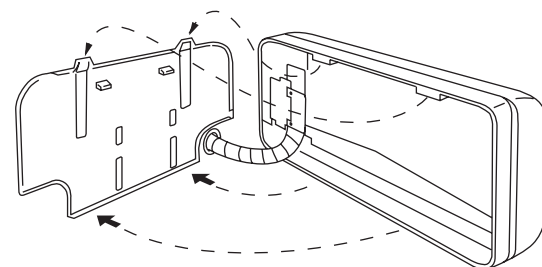


Fig. 36

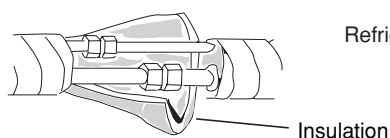


Fig. 37a

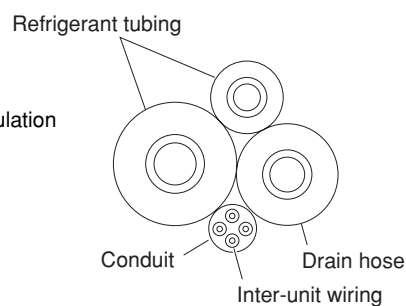
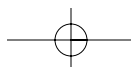


Fig. 37b



**Left-side tubing**

- (1) Lead the tubing and drain hose through the wall, allowing sufficient length for connection. Then bend the tubing using a tube bender to make the attachment. (Fig. 38)
- (2) Switch the drain hose and drain cap.

**Switching drain hose and drain cap**

- (a) Locate the drain hose and the drain cap. (Fig. 39)
- (b) Remove the screws fastening the drain hose on the right side, and pull out the drain hose to remove it. (Fig. 39)
- (c) Apply moderate force to pull off the drain cap on the left side. (If you cannot pull it off by hand, use a long-nose pliers.)
- (d) Reattach the drain hose to the left side and the drain cap to the right side. (Fig. 40a)

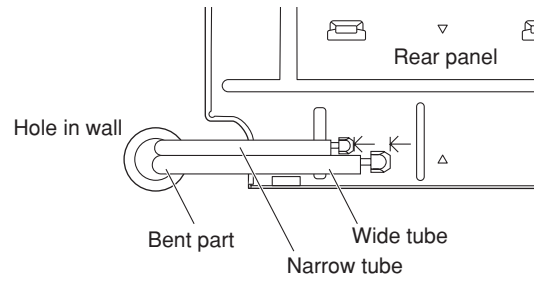
**Drain hose**

Slide the drain hose fully onto the drain pan outlet until the drain hose edge is pushed into the insulation. Check that the screw holes in the drain bracket and the drain pan outlet are aligned and securely in contact, then fasten them with the screw. (After attaching the drain hose, check that it is attached securely.) (Fig. 40c)

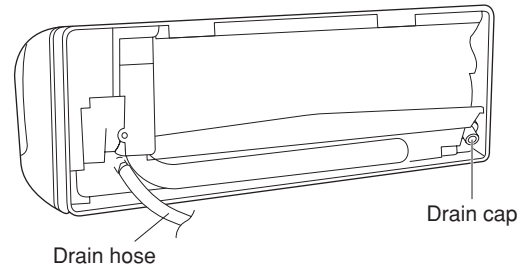
**Drain cap**

Use a Phillips screwdriver to push the drain cap in firmly. (If it is difficult to push in, wet the cap with water first.)

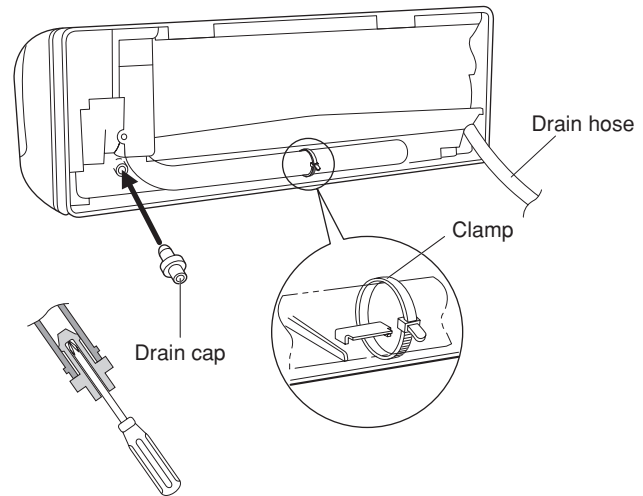
- (3) Install the indoor unit on the rear panel.
- (4) Connect the tubing and wiring led inside from outdoors.
- (5) After completing a leak test, bundle the tubing together with armoring tape and store it inside the tubing storage area at the back of the indoor unit and hold it with clamps. (Figs. 40a and 41)



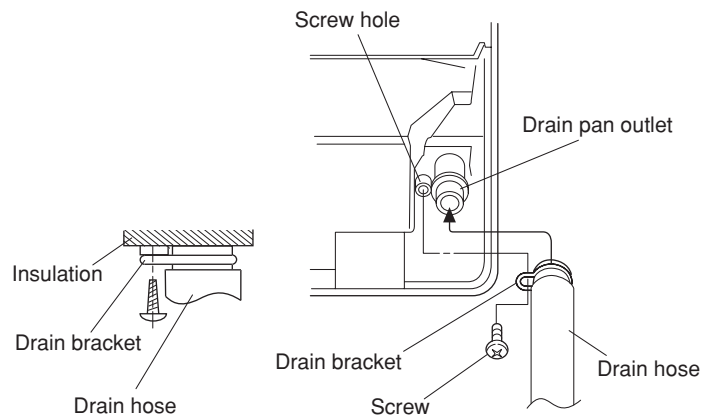
**Fig. 38**



**Fig. 39**

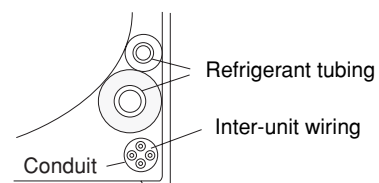


**Fig. 40a**



**Fig. 40c**

**Fig. 40b**



**Fig. 41**


**To unmount indoor unit**

Press the 2 △ marks on the lower part of the indoor unit and unlatch the tabs. Then lift the indoor unit and unmount. (Fig. 42)


**3-10. Drain Hose**

- a) The drain hose should be slanted downward to the outdoors. (Fig. 43)
- b) Never form a trap in the course of the hose.
- c) If the drain hose will run in the room, insulate the hose with insulation\* so that chilled condensation will not damage furniture or floors. (Fig. 44)

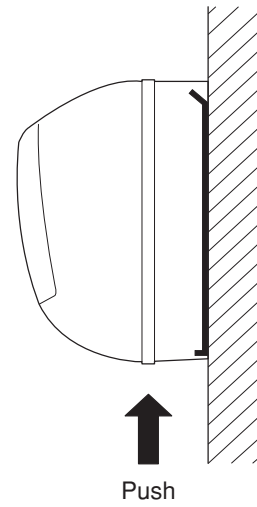
\* Foamed polyethylene or its equivalent is recommended.



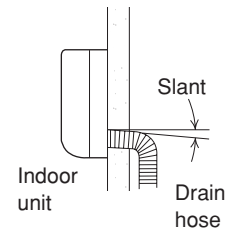
**WARNING** Do not supply power to the unit or operate it until all tubing and wiring to the outside unit are completed.



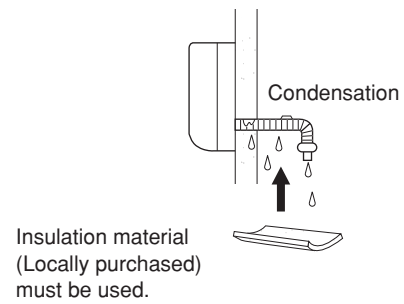
**Risk of Electric Shock**



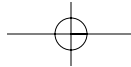
**Fig. 42**



**Fig. 43**



**Fig. 44**



## 4. How to Install the Outdoor Unit

First refer to Section 2. Installation Site Selection.

### 4-1. Wiring Instructions for the Outdoor Unit

Regulations on wire size differ from locality to locality. For field wiring requirements, please refer to your local electrical codes. Make sure that the installation fully complies with all local and national regulations.

- (1) Remove access panel "C". (Fig. 46)
- (2) Connect the inter-unit and power supply line according to the drawing on the panel side.
- (3) Be sure to size each wire allowing approx. 4" (10 cm) longer than the required length for wiring. Store excess wiring inside the cabinet.
- (4) When connections are completed, check that all connections are correct as shown in the wiring system diagram on panel side.
- (5) Be sure to ground the unit according to your local codes.

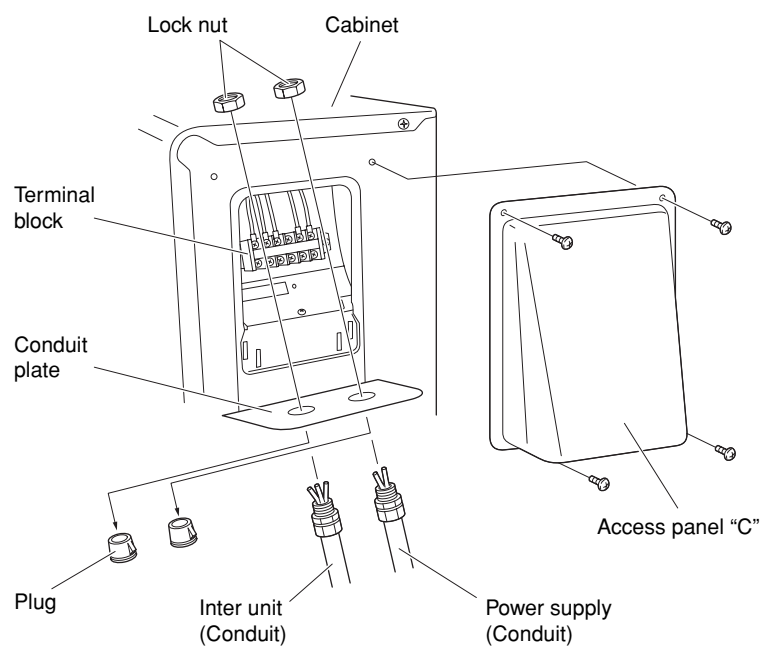
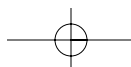
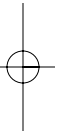
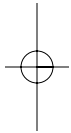


Fig. 46





## 5. Refrigerant Tubing

### 5-1. Use of the Flaring Method

Many of the conventional split system air conditioners employ the flaring method to connect refrigerant tubes which run between indoor and outdoor units. In this method, the copper tubes are flared at each end and connected with flare nuts.

### 5-2. Flaring Procedure with a Flare Tool

- (1) Cut the copper tube to the required length with a tube cutter. It is recommended to cut approx. 12" to 20" (30 to 50 cm) longer than the tubing length you estimate.
- (2) Remove burrs at the end of the copper tube with a tube reamer or file. This process is important and should be done carefully to make a good flare. (Fig. 47)

#### NOTE

When reaming, hold the tube end downward and be sure that no copper scraps fall into the tube. (Fig. 48)

- (3) Remove the flare nut from the unit and be sure to mount it on the copper tube.
- (4) Make a flare at the end of copper tube with a flare tool.\* (Figs. 49a and 49b)

(\*Use "RIGID" or equivalent.)

#### NOTE

A good flare should have the following characteristics:

- inside surface is glossy and smooth.
- edge is smooth.
- tapered sides are of uniform length.

### 5-3. Caution before Connecting Tubes Tightly

- a) Be sure to apply a sealing cap or water-proof tape to prevent dust or water from getting into the tubes before they are used.
- b) Be sure to apply refrigerant lubricant to the matching surfaces of the flare and union before connecting them together. This is effective for reducing gas leaks. (Fig. 50)
- c) For proper connection, align the union tube and flare tube straight with each other, then screw in the flare nut lightly at first to obtain a smooth match. (Fig. 51)

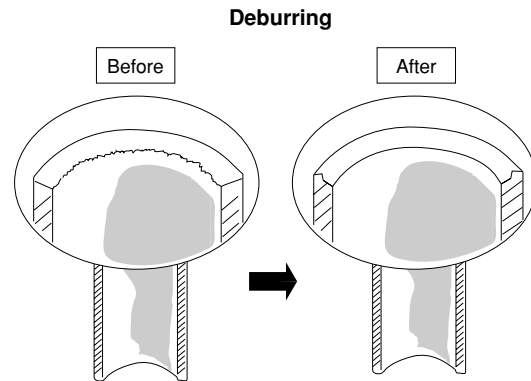


Fig. 47

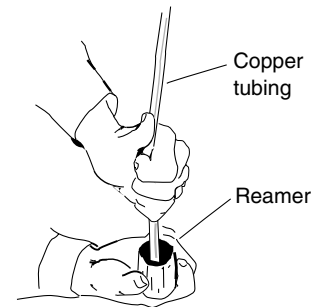
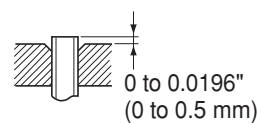
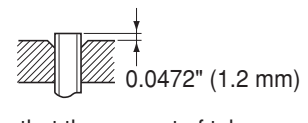


Fig. 48

If the special R410A flare tool is used:



If the previous flare tool (clutch-type) is used:



Adjust so that the amount of tube protrusion is as shown in the figure.

Fig. 49a

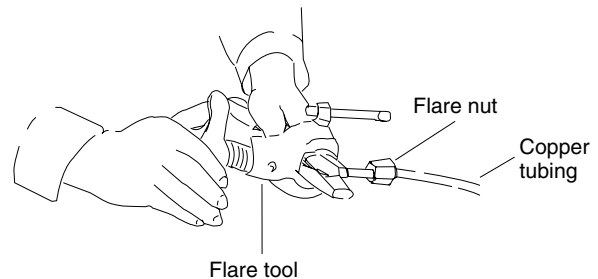


Fig. 49b

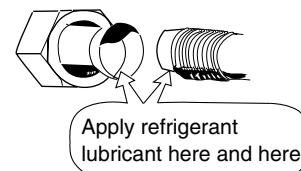


Fig. 50

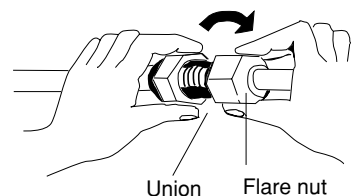


Fig. 51

### 5-4. Connecting Tubing between Indoor and Outdoor Units

- a) Tightly connect the indoor side refrigerant tubing extended from the wall with the outdoor side tubing. (Fig. 52)
- b) To fasten the flare nuts, apply specified torque as:

**Table 6**

Tube Dia.	Tightening Torque
1/4" (6.35 mm)	Approx. 120 – 160 lbs·in (140 – 180 kgf·cm)
3/8" (9.52 mm)	Approx. 300 – 360 lbs·in (340 – 420 kgf·cm)
1/2" (12.70 mm)	Approx. 430 – 540 lbs·in (490 – 610 kgf·cm)
5/8" (15.88 mm)	Approx. 590 – 710 lbs·in (680 – 820 kgf·cm)

### 5-5. Insulation of Refrigerant Tubing

**IMPORTANT**

To prevent heat loss and wet floors due to dripping of condensation, **both tubes must be well insulated with a proper insulation material.** (Fig. 53)

The thickness of the insulation should be a minimum 5/16" (8 mm). (Fig. 54)

### 5-6. Taping the Tubes



**CAUTION**

After a tube has been insulated, never try to bend it into a narrow curve, as this may cause the tube to break or crack.

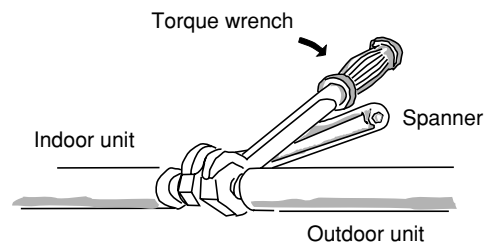
- (1) At this time, the 2 refrigerant tubes (and electrical wire if local codes permit) should be taped together with armoring tape. The drain hose may also be included and taped together as 1 bundle with the tubing.
- (2) Wrap the armoring tape from the bottom of the outdoor unit to the top of the tubing where it enters the wall. As you wrap the tubing, overlap half of each previous tape turn. (Fig. 55)
- (3) Clamp the tubing bundle to wall, using 1 clamp approx. every 47" (120 cm).

**NOTE**

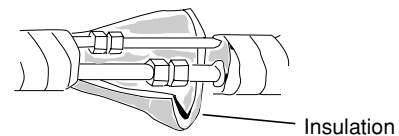
Do not wind the armoring tape too tightly, since this will decrease the heat insulation effect. Also, be sure the condensation drain hose splits away from the bundle and drips clear of the unit and the tubing.

### 5-7. Finishing the Installation

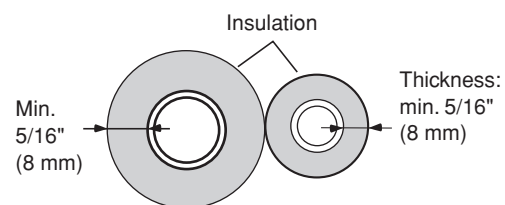
After finishing insulating and taping over the tubing, use sealing putty to seal off the hole in the wall to prevent rain and draft from entering. (Fig. 56)



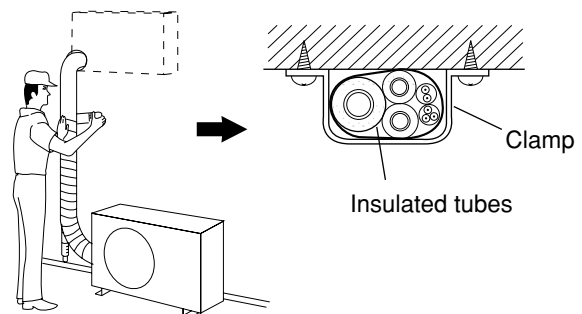
**Fig. 52**



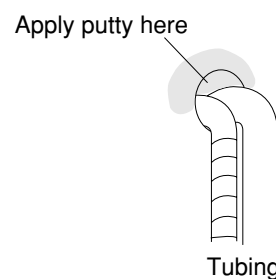
**Fig. 53**



**Fig. 54**



**Fig. 55**



**Fig. 56**

## 6. Air Purging

Air and moisture remaining in the refrigerant system have undesirable effects as indicated below. Therefore, they must be purged completely.

- pressure in the system rises
- operating current rises
- cooling (or heating) efficiency drops
- moisture in the air may freeze and block capillary tubing
- water may lead to corrosion of parts in the refrigerant system

### ■ Air Purging with a Vacuum Pump (for Test Run)

- (1) Check that each tube (both narrow and wide tubes) between the indoor and outdoor units have been properly connected and all wiring for the test run has been completed. Note that both narrow and wide tube service valves on the outdoor unit are kept closed at this stage.
- (2) Using an adjustable wrench or box wrench, remove the valve caps from the service valve on both narrow and wide tubes.
- (3) Connect a vacuum pump and a manifold valve (with pressure gauges) to the service port on the wide tube service valve. (Fig. 57)



**CAUTION**

The service port on the wide tube service valve uses a Schrader core valve to access the refrigerant system. The valve core is similar to those used in automobile tires. Therefore, be sure to use a vacuum hose connector which has a push-pin inside.



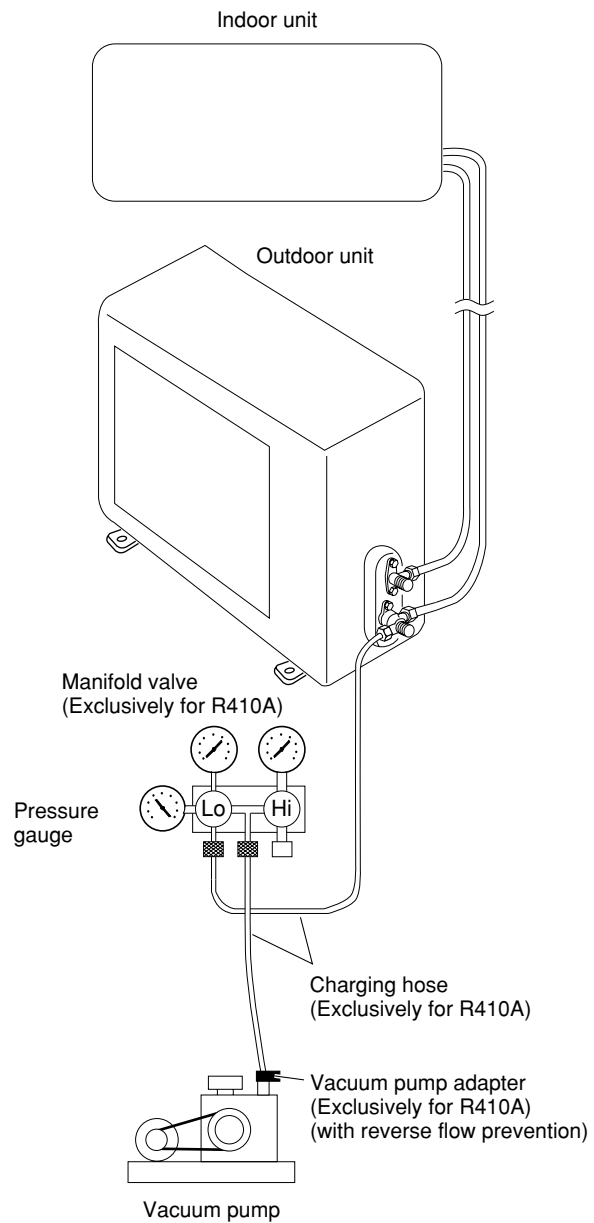
**CAUTION**

Be sure to use a manifold valve for air purging. If it is not available, use a stop valve (field supply) for this purpose. The “Hi” knob of the manifold valve must always be kept closed.

- (4) With the “Lo” knob of the manifold valve open, run the vacuum pump. The operation time for the vacuum pump varies with tubing length and the capacity of the pump. The following table shows the amount of time for evacuation:

**Table 7**

Required time for evacuation when 100 liter/h vacuum pump is used	
If tubing length is less than 33 ft. (10 m)	If tubing length is more than 33 ft. (10 m)
<b>10 min. or more</b>	<b>15 min. or more</b>



**Fig. 57**

**NOTE**

To prevent other refrigerants from being mistakenly charged to units which use R410A, the size of the charge port on the service valve is different from the one for other refrigerant types. For servicing such as recharging, the specified charging hose, manifold and vacuum pump adapter (with reverse flow prevention) for R410A must be used.

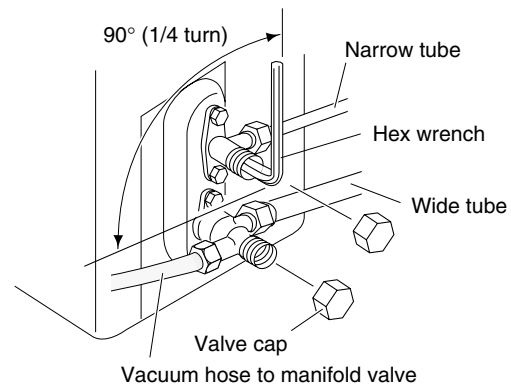
**NOTE**

The required time in Table 7 is calculated based on the assumption that the ideal (or target) vacuum condition is around 10 mmHg abs.

- (5) With the vacuum pump still running, close the "Lo" knob of the manifold valve. Then stop the vacuum pump.
- (6) With the accessory hex wrench, turn the valve stem on the narrow tube service valve counter-clockwise by 90 degrees (1/4 turn) for 10 seconds, and then turn the stem clockwise to close it again. (Fig. 58)

**CAUTION**

**Be sure to completely insert the hex wrench before attempting to turn the valve.**

**Fig. 58**

- (7) Leak test all joints at the tubing (both indoor and outdoors) with soapy water. Bubbles indicate a leak. Tighten the joint more when leaks, then check if there is no leak. Be sure to wipe off the soap with a clean cloth.
- (8) With the hex wrench, turn the wide tube service valve stem counter-clockwise to fully open the valve.
- (9) Turn the narrow tube service valve stem counter-clockwise to fully open the valve.
- (10) Loosen the vacuum hose connected to the wide tube service port slightly to release the pressure. Then, remove the hose.

**CAUTION**

**This may cause the refrigerant gas to leak. In order to avoid this, take off the hose quickly.**

- (11) Fasten the valve cap on the wide tube service port securely with an adjustable wrench or box wrench. Next, mount the valve cap on the service valve and tighten it to 170 lbs·in (200 kgf·cm) with a torque wrench. This process is very important to prevent gas from leaking from the system.
- (12) Test run the air conditioner. (See next page.)
- (13) While the air conditioner is running, apply liquid soap to check for any gas leaks around the service valves or caps.
- (14) If there is no leakage, stop the air conditioner.
- (15) Wipe off the soap on the tubing.

This completes air purging with a vacuum pump and the air conditioner is ready for actual operation.

### How to Test Run the Air Conditioner

After turning on power to the air conditioner, use the remote controller and follow the steps below to conduct the test run.

- (1) Set the remote controller in Test Run mode. (Fig. 59a)
  - a) Press and hold the ION button.
  - b) Then press and hold the 1HR TIMER button.
  - c) At the same time, press the ACL (reset) button once. Use a pointed object such as the tip of a pen to press the ACL button.
    - After a few seconds, “⌘” appears and “oP-1” blinks in the remote controller display area. (Fig. 59b)
  - d) Release the 1HR TIMER button.
  - e) Release the ION button.
- (2) Start Cooling mode test run by pressing the ON/OFF operation button of the remote controller. (Fig. 59a)
  - This starts the fan producing uncooled forced air with the 4 indicator lamps (OPERATION lamp, TIMER lamp, QUIET lamp, and ION lamp) on the main unit blinking. (Fig. 59c)
  - After 3 minutes, the system shifts into cooling operation, and cool air will start to be felt. Cool mode test run is unaffected by the room temperature.
- (3) Press the ON/OFF operation button of the remote controller again to stop the test run. (Fig. 59a)
- (4) Finally press the ACL (reset) button of the remote controller to release it from Test Run mode to return to normal mode. (Fig. 59a)
  - “⌘” and “oP-1” will disappear from the remote controller display area.

#### IMPORTANT

After the test run is completed, be sure to press the ACL (reset) button to return to normal mode. The air conditioner will not operate correctly if this is not done.

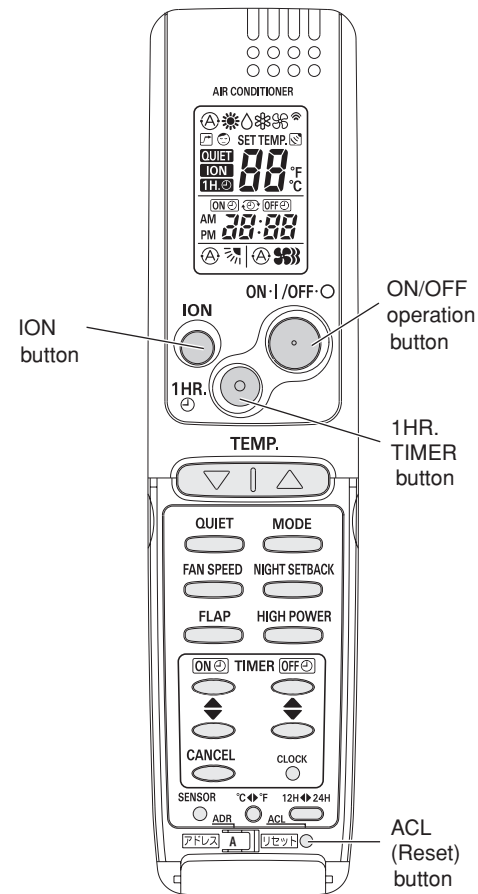


Fig. 59a

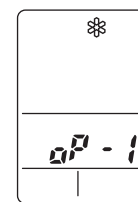


Fig. 59b

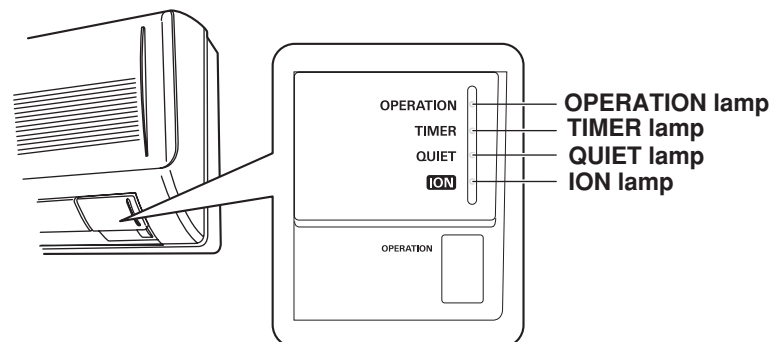
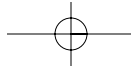


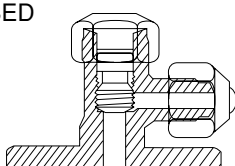
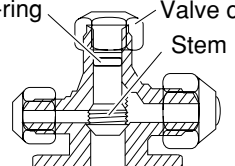
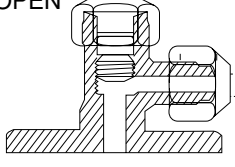
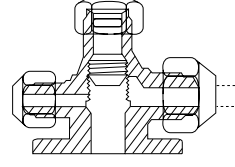
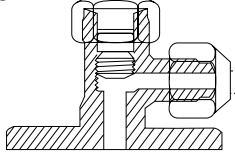
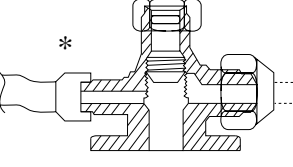
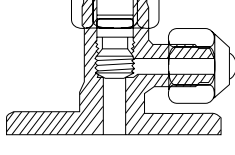
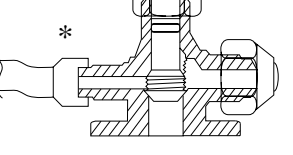
Fig. 59c




### Basic Functions of the Service Valves

The basic functions of the service valves are given in Table 8 below.

Table 8

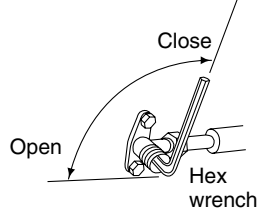
Action	Narrow Tube Service Valve (2-Way)	Wide Tube Service Valve (3-Way)
Shipping	CLOSED 	O-ring Valve cap Stem 
Operating and test running the air conditioner	Fully OPEN 	
Measuring pressure and gas charging	Fully OPEN 	* 
Air purging with a vacuum pump	CLOSED 	* 

\* The service port on the wide tube service valve uses a Schrader core valve to access the refrigerant system. Therefore, be sure to use a hose connector which has a push-pin inside. (Fig. 60a)



**CAUTION**

When opening or closing the service valve stem, use the accessory hex wrench. Be sure to fully seat the wrench before turning the valve.



Close  
Open  
Hex wrench

**Fig. 60b**

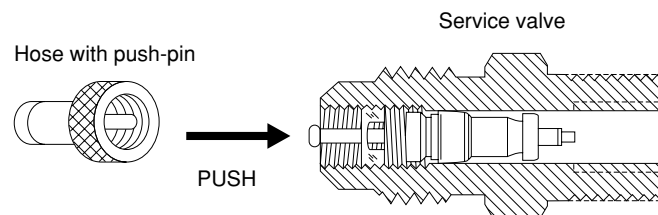


Fig. 60a

### Pump Down

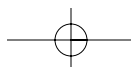
Pump down means collecting all refrigerant gas in the system back into the outdoor unit without losing any of the gas. Pump down is used when the unit is to be moved or before servicing the refrigerant circuit.

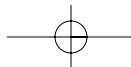
#### Pump Down Procedure

**Be sure to carry out pump down with the unit in cooling mode.**

- (1) Connect the Lo side charging hose of the manifold valve to the service port on the wide tube service valve.

- (2) Using a hex wrench, turn the narrow tube service valve clockwise all the way to close the service valve. (Be sure to confirm that the wide tube service valve is fully open.)
- (3) Press the operation button and start cooling operation.
- (4) When the low pressure gauge reading falls to 14.2 to 7.1 psi (1 to 0.5 kg/cm<sup>2</sup>), fully close the wide tube valve stem. Then quickly stop the unit.
- (5) Disconnect all gauges and hoses, and replace the valve caps as they were before.





## 7. Remote Control Unit Installation Position

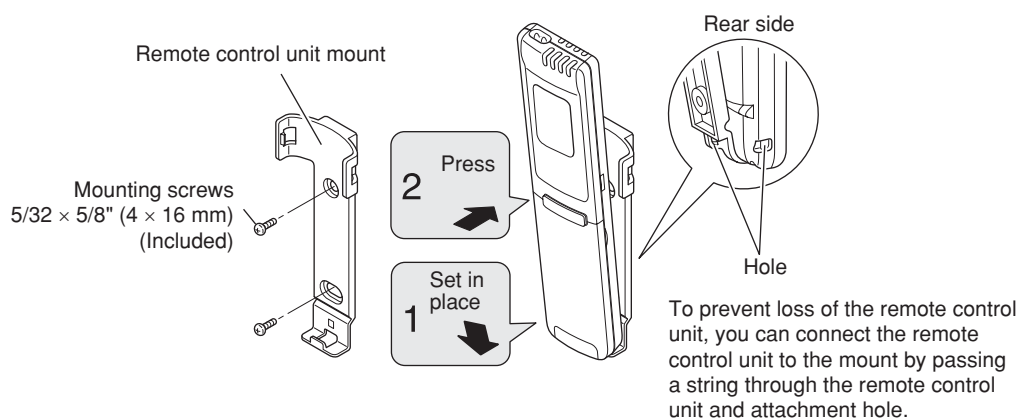
The remote control unit can be operated from either a non-fixed position or a wall-mounted position.

To ensure that the air conditioner operates correctly, do not install the remote control unit in the following places:

- In direct sunlight
- Behind a curtain or other place where it is covered
- More than 26' (8 m) away from the air conditioner
- In the path of the air conditioner's airstream
- Where it may become extremely hot or cold
- Where it may be subject to electrical or magnetic interference
- Where there is an obstacle between the remote control unit and the air conditioner (since a check signal is sent from the remote control unit every 5 minutes)

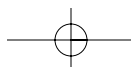
### 7-1. Mounting on a Wall

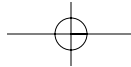
Before mounting the remote control unit, press the ON/OFF operation button at the mounting location to make sure that the air conditioner operates from that location. The indoor unit should make a beeping sound to indicate that it has received the signal.



**To take out the remote control unit, pull it forward.**

**Fig. 61**





## 8. Address Switch

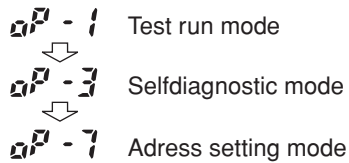
### 8-1. Address Setting of the Remote Control Unit

The address can be set in order to prevent interference between remote controllers when two Sanyo indoor units are installed near each other. The address is normally set to "A." To set a different address, it is necessary to change the address on the second remote controller.

#### NOTE

Once changed, you cannot restore the original address setting of the air conditioner.

- (1) Switch on the power source.
- (2) Break the address-setting tab marked "A" on the second remote controller to change the address (Fig. 62). When the tab is removed, the address is automatically set to B (Fig. 63).
- (3) Press and hold the remote controller ION button and 1 HR TIMER button. At the same time, press the ACL(reset) button. Use a thin object such as the tip of a pen to press the ACL button. When this has been done, "oP-1" (test run) appears, blinking, in the remote controller clock display area.
- (4) Each time the 1 HR TIMER button is pressed, the display changes as shown below. Press this button 2 times to change the display to "oP-7" (address setting).



- (5) "oP-7" has now been selected for address setting.
- (6) Press the ON/OFF operation button on the remote controller. (Fig. 64) Check that the "beep" signal-received sound is heard from the second indoor unit (approximately 5 times). The sound you hear is the signal that the remote controller address has been changed.
- (7) Finally press the remote controller ACL (reset) button to cancel the blinking "oP-7" display. (Fig. 64)

Changing of the second remote controller address is now completed.

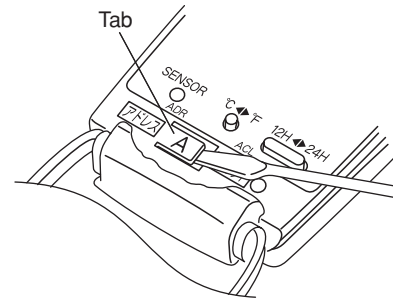


Fig. 62

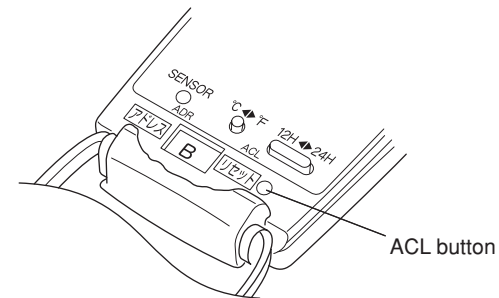


Fig. 63

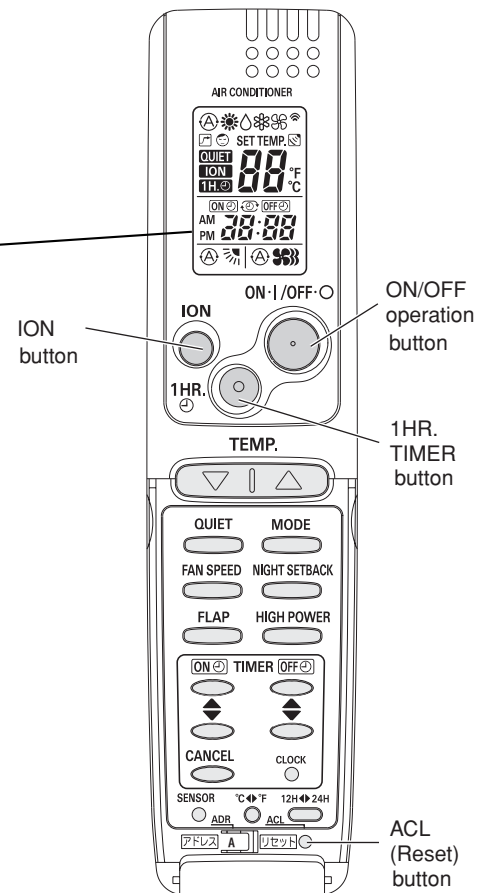
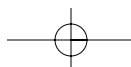


Fig. 64





## Free Manuals Download Website

<http://myh66.com>

<http://usermanuals.us>

<http://www.somanuals.com>

<http://www.4manuals.cc>

<http://www.manual-lib.com>

<http://www.404manual.com>

<http://www.luxmanual.com>

<http://aubethermostatmanual.com>

Golf course search by state

<http://golfingnear.com>

Email search by domain

<http://emailbydomain.com>

Auto manuals search

<http://auto.somanuals.com>

TV manuals search

<http://tv.somanuals.com>