

SANYO INSTALLATION INSTRUCTIONS

– Split System Heat Pump Air Conditioner –

Model Combinations

Combine indoor and outdoor units only as listed below.

Indoor Units and Outdoor Units

	Indoor Unit Type	26	30	36	42	Remarks
X	4-Way Air Discharge Semi-Concealed	XH2672R		XH3672R	XH4272R	Optional remote controller
		XHW2672R		XHW3672R	XHW4272R	with Wired Remote Controller: RCS-TM80BG
K	Wall-Mounted	KH2672R	KH3072R	KH3672R		Optional remote controller
		KHS2672R	KHS3072R	KHS3672R		with Wireless Remote Controller: RCS-SH1UA
		KHH2672R				Optional remote controller
		KHHS2672R				with Wireless Remote Controller: RCS-SH1UA
T	Ceiling-Mounted	TH2672R		TH3672R	TH4272R	Optional remote controller
		THW2672R		THW3672R	THW4272R	with Wired Remote Controller: RCS-TM80BG
		THH2672R		THH3672R		Unit with Back-up heater
		THHW2672R		THHW3672R		Unit with Back-up heater with Wired Remote Controller: RCS-TM80BG
U	Concealed-Duct	UH2672R		UH3672R		Optional remote controller
		UHW2672R		UHW3672R		with Wired Remote Controller: RCS-TM80BG
C	Outdoor Units	CH2672R	CH3072R	CH3672R	CH4272R	H/P
		C2672R	C3072R	C3672R	C4272R	S/C
RC (WD)	Wired Remote Controller	RCS-SH80UG (Optional part)				
RC (WL)	Wireless Remote Controller	Built-in type: RCS-SH80UA.WL (Optional part)				for X and T type Indoor units
		External type: RCS-BH80UA.WL (Optional part)				for U type Indoor units
		Built-in type: RCS-SH80UA (Accessory part / Optional part)				for K type Indoor units
TRC	Timer Remote Controller	RCS-TM80BG* (Accessory part / Optional part)				for X, T and U type Indoor units. * Timer Remote Controller comes with Owner's Manual and Installation Instructions.
SC	System Controller	SHA-KC64UG (Optional part)				

OPERATING LIMITS

- Maximum Conditions Cooling / Heating
 Outdoor temperature : 109°F DB / 65°F WB
 Room temperature : 71°F WB / 80°F DB
- Minimum Conditions
 Outdoor temperature : 0°F* DB / 5°F WB
 Room temperature : 57°F WB / 59°F DB

* When air discharge chamber is installed.

Units should be installed by licensed contractor according to local code requirements.

SANYO Commercial Solutions
 A division of SANYO North America Corporation
 Cornerstone Business Park
 1062 Thorndale Avenue
 Bensenville, IL 60106, U.S.A.

In Canada
SANYO Canada Inc.
 1-300 Applewood Crescent
 Concord, Ontario
 L4K 5C7, Canada

85464359863005 ©SANYO 2007



X
K
T
U
C
RC (WD)
RC (WL)
TRC
SC

IMPORTANT! Please Read Before Starting

This air conditioning system meets strict safety and operating standards. As the installer or service person, it is an important part of your job to install or service the system so it operates safely and efficiently.

For safe installation and trouble-free operation, you must:

- Carefully read this instruction booklet before beginning.
- Follow each installation or repair step exactly as shown.
- Observe all local, state, and national electrical codes.
- Pay close attention to all warning and caution notices given in this manual.



WARNING

This symbol refers to a hazard or unsafe practice which can result in severe personal injury or death.



CAUTION

This symbol refers to a hazard or unsafe practice which can result in personal injury or product or property damage.

If Necessary, Get Help

These instructions are all you need for most installation sites and maintenance conditions. If you require help for a special problem, contact our sales/service outlet or your certified dealer for additional instructions.

In Case of Improper Installation

The manufacturer shall in no way be responsible for improper installation or maintenance service, including failure to follow the instructions in this document.

SPECIAL PRECAUTIONS

WARNING When Wiring



ELECTRICAL SHOCK CAN CAUSE SEVERE PERSONAL INJURY OR DEATH. ONLY A QUALIFIED, EXPERIENCED ELECTRICIAN SHOULD ATTEMPT TO WIRE THIS SYSTEM.

- Do not supply power to the unit until all wiring and tubing are completed or reconnected and checked.
- Highly dangerous electrical voltages are used in this system. Carefully refer to the wiring diagram and these instructions when wiring. Improper connections and inadequate grounding can cause **accidental injury or death**.
- **Ground the unit** following local electrical codes.
- Connect all wiring tightly. Loose wiring may cause overheating at connection points and a possible fire hazard.

When Transporting

Be careful when picking up and moving the indoor and outdoor units. Get a partner to help, and bend your knees when lifting to reduce strain on your back. Sharp edges or thin aluminum fins on the air conditioner can cut your fingers.

When Installing...

...In a Room

Properly insulate any tubing run inside a room to prevent "sweating" that can cause dripping and water damage to walls and floors.

...In Moist or Uneven Locations

Use a raised concrete pad or concrete blocks to provide a solid, level foundation for the outdoor unit. This prevents water damage and abnormal vibration.

...In an Area with High Winds

Securely anchor the outdoor unit down with bolts and a metal frame. Provide a suitable air baffle.

...In a Snowy Area (for Heat Pump-type Systems)

Install the outdoor unit on a raised platform that is higher than drifting snow. Provide snow vents.

When Connecting Refrigerant Tubing

- Ventilate the room well, in the event that is refrigerant gas leaks during the installation. Be careful not to allow contact of the refrigerant gas with a flame as this will cause the generation of poisonous gas.
- Keep all tubing runs as short as possible.
- Use the flare method for connecting tubing.
- Apply refrigerant lubricant to the matching surfaces of the flare and union tubes before connecting them, then tighten the nut with a torque wrench for a leak-free connection.
- Check carefully for leaks before starting the test run.

When Servicing

- Turn the power OFF at the main power box (mains) before opening the unit to check or repair electrical parts and wiring.
- Keep your fingers and clothing away from any moving parts.



CAUTION

- Clean up the site after you finish, remembering to check that no metal scraps or bits of wiring have been left inside the unit being serviced.
- Ventilate any enclosed areas when installing or testing the refrigeration system. Escaped refrigerant gas, on contact with fire or heat, can produce dangerously toxic gas.
- Confirm after installation that no refrigerant gas is leaking. If the gas comes in contact with a burning stove, gas water heater, electric room heater or other heat source, it can cause the generation of poisonous gas.

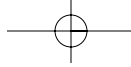

Check of Density Limit

The room in which the air conditioner is to be installed requires a design that in the event of refrigerant gas leaking out, its density will not exceed a set limit.

The refrigerant (R410A), which is used in the air conditioner, is safe, without the toxicity or combustibility of ammonia, and is not restricted by laws imposed to protect the ozone layer. However, since it contains more than air, it poses the risk of suffocation if its density should rise excessively. Suffocation from leakage of refrigerant is almost non-existent. With the recent increase in the number of high density buildings, however, the installation of multi air conditioner systems is on the increase because of the need for effective use of floor space, individual control, energy conservation by curtailing heat and carrying power, etc.

Most importantly, the multi air conditioner system is able to replenish a large amount of refrigerant compared to conventional individual air conditioners. If a single unit of the multi air conditioner system is to be installed in a small room, select a suitable model and installation procedure so that if the refrigerant accidentally leaks out, its density does not reach the limit (and in the event of an emergency, measures can be made before injury can occur).

In a room where the density may exceed the limit, create an opening with adjacent rooms, or install mechanical ventilation combined with a gas leak detection device. The density is as given below.

Total amount of refrigerant (oz.)

$$\text{Min. volume of the indoor unit installed room (ft.}^3) \leq \text{Density limit (oz./ft.}^3)$$

The density limit of refrigerant which is used in multi air conditioners is 0.3 oz./ft.³ (ISO 5149).

NOTE

1. If there are 2 or more refrigerating systems in a single refrigerating device, the amount of refrigerant should be as charged in each independent device.

For the amount of charge in this example:

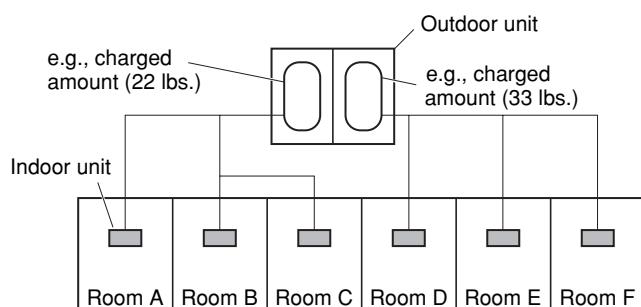

The possible amount of leaked refrigerant gas in rooms A, B and C is 22 lbs.
 The possible amount of leaked refrigerant gas in rooms D, E and F is 33 lbs.

2. The standards for minimum room volume are as follows.

- (1) No partition (shaded portion)

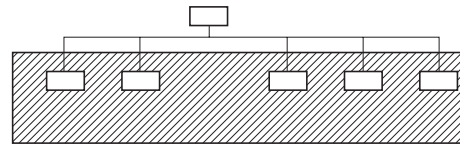

- (2) When there is an effective opening with the adjacent room for ventilation of leaking refrigerant gas (opening without a door, or an opening 0.15% or larger than the respective floor spaces at the top or bottom of the door).

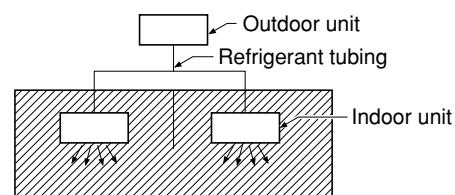

- (3) If an indoor unit is installed in each partitioned room and the refrigerant tubing is interconnected, the smallest room of course becomes the object. But when mechanical ventilation is installed interlocked with a gas leakage detector in the smallest room where the density limit is exceeded, the volume of the next smallest room becomes the object.

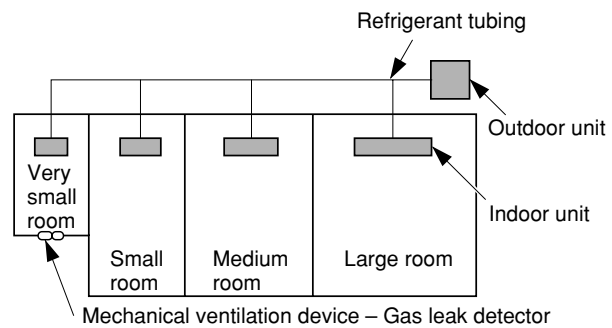

3. The minimum indoor floor space compared with the amount of refrigerant is roughly as follows (when the ceiling is 9 ft. high):

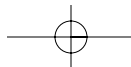
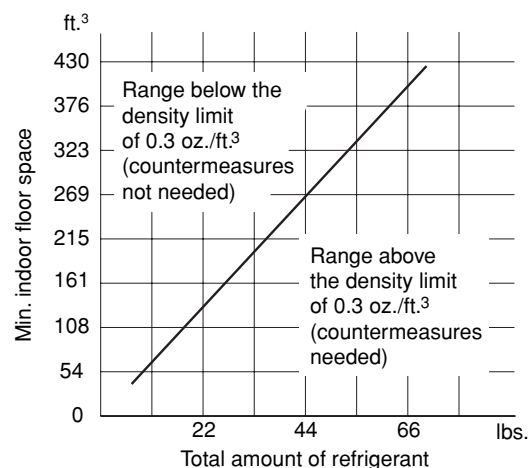

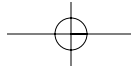

Precautions for Installation Using New Refrigerant

1. Care regarding tubing

1-1. Process tubing

- Material: Use C1220 phosphorous deoxidized copper specified in JIS H3300 "Copper and Copper Alloy Seamless Pipes and Tubes."
- **Tubing size: Be sure to use the sizes indicated in the table below.**
- Use a tube cutter when cutting the tubing, and be sure to remove any flash. This also applies to distribution joints (optional).
- When bending tubing $\phi 5/8"$ or smaller, use a bending radius that is 4 times the outer diameter of the tubing or larger.



CAUTION

Use sufficient care in handling the tubing. Seal the tubing ends with caps or tape to prevent dirt, moisture, or other foreign substances from entering. These substances can result in system malfunction.

Unit: inch

Material		O			
Copper tube	Outer diameter	1/4	3/8	1/2	5/8
	Wall thickness	1/32	1/32	1/32	5/128

1-2. Prevent impurities including water, dust and oxide from entering the tubing. Impurities can cause R410A refrigerant deterioration and compressor defects. Due to the features of the refrigerant and refrigerating machine oil, the prevention of water and other impurities becomes more important than ever.

2. Be sure to recharge the refrigerant only in liquid form.

- 2-1. Since R410A is a non-azeotrope, recharging the refrigerant in gas form can lower performance and cause defects of the unit.
- 2-2. Since refrigerant composition changes and performance decreases when gas leaks, collect the remaining refrigerant and recharge the required total amount of new refrigerant after fixing the leak.

3. Different tools required

3-1. Tool specifications have been changed due to the characteristics of R410A. Some tools for R22- and R407C-type refrigerant systems cannot be used.

Item	New tool?	R407C tools compatible with R410A?	Remarks
Manifold gauge	Yes	No	Types of refrigerant, refrigerating machine oil, and pressure gauge are different.
Charge hose	Yes	No	To resist higher pressure, material must be changed.
Vacuum pump	Yes	Yes	Use a conventional vacuum pump if it is equipped with a check valve. If it has no check valve, purchase and attach a vacuum pump adapter.
Leak detector	Yes	No	Leak detectors for CFC and HCFC that react to chlorine do not function because R410A contains no chlorine. Leak detector for HFC134a can be used for R410A.
Flaring oil	Yes	No	For systems that use R22, apply mineral oil (Suniso oil) to the flare nuts on the tubing to prevent refrigerant leakage. For machines that use R407C or R410A, apply synthetic oil (ether oil) to the flare nuts.

Manifold gauge

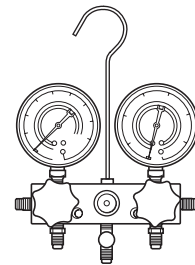

Vacuum pump

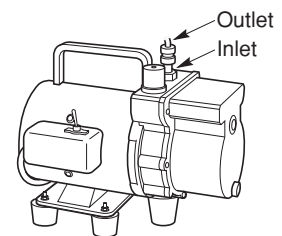

* Using tools for R22 and R407C and new tools for R410A together can cause defects.

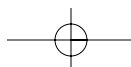

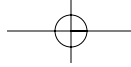

3-2. Use R410A exclusive cylinder only.

- When charging with a refrigerant cylinder, use an electronic scale for charging refrigerant. In this case, if the volume of refrigerant in the cylinder becomes less than 20% of the fully-charged amount, the composition of the refrigerant starts to change. Thus, do not use the refrigerant if the amount in the charging cylinder is less than 20%. Also, charge the minimum necessary amount to the charging cylinder before using it to charge the air conditioning unit.

Configuration and characteristics of cylinders

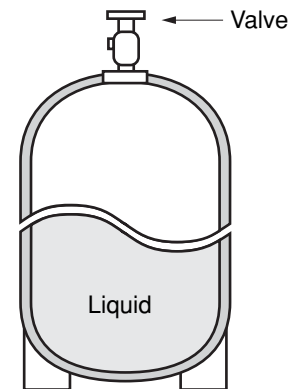

Single valve
Charge liquid refrigerant with cylinder in up-side-down position.

Fig. 1

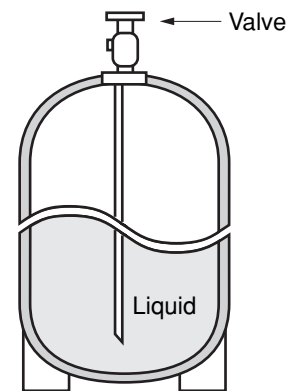

Single valve (with siphon tube)
Charge with cylinder in normal position.

Fig. 2

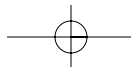

CONTENTS

	Page		Page
IMPORTANT!	2	■ Concealed-Duct Type (U Type)	51
Please Read Before Starting		3-22. Required Minimum Space for Installation and Service	
Check of Density Limit		3-23. Suspending the Indoor Unit	
Precautions for Installation Using New Refrigerant		3-24. Installing the Drain Piping	
1. GENERAL	8	3-25. Checking the Drainage	
1-1. Tools Required for Installation (not supplied)		3-26. Increasing the Fan Speed	
1-2. Accessories Supplied with Outdoor Unit		4. HOW TO INSTALL THE OUTDOOR UNIT	56
1-3. Type of Copper Tube and Insulation Material		4-1. Installing the Outdoor Unit	
1-4. Additional Materials Required for Installation		4-2. Drainage Work	
1-5. Tubing Size		4-3. Routing the Tubing and Wiring	
2. SELECTING THE INSTALLATION SITE	16	5. ELECTRICAL WIRING	57
2-1. Indoor Unit		5-1. General Precautions on Wiring	
2-2. Outdoor Unit		5-2. Recommended Wire Length and Wire Diameter for Power Supply System	
2-3. Air-Discharge Chamber for Top Discharge		5-3. Wiring System Diagrams	
2-4. Installing the Unit in Heavy Snow Areas		5-4. How to Connect Wiring to the Terminal	
2-5. Precautions for Installation in Heavy Snow Areas		6. HOW TO INSTALL THE WIRED REMOTE CONTROLLER (OPTIONAL PART)	60
2-6. Dimensions of Wind Ducting		6-1. Installation Site Selection	
2-7. Dimensions of Snow Ducting		6-2. Wired Remote Controller Installation	
3. HOW TO INSTALL THE INDOOR UNIT	26	6-3. Basic Wiring Diagram	
■ 4-Way Air Discharge Semi-Concealed Type (X Type)	26	6-4. Wiring System Diagram for Group Control	
3-1. Suspending the Indoor Unit		6-5. Wiring System Diagram for Multiple Remote Controllers	
3-2. Preparation for Suspending		6-6. How to Switch the Indoor Temperature Sensor	
3-3. Placing the Unit Inside the Ceiling		6-7. Trouble Diagnostics	
3-4. Installing the Drain Piping		7. HOW TO INSTALL THE WIRELESS REMOTE CONTROLLER (ACCESSORY PART / OPTIONAL PART)	68
3-5. Checking the Drainage		7-1. Wireless Remote Controller Installation	
3-6. Before Installing the Ceiling Panel		7-2. Room Temperature Sensor Setting	
3-7. Installing the Ceiling Panel		7-3. Address Switches	
3-8. When Removing the Ceiling Panel for Servicing		7-4. Setting the Model Code	
3-9. Duct for Fresh Air		<RCS-SH80UA.WL>	
■ Wall-Mounted Type (K Type)	34	■ 4-Way Air Discharge Semi-Concealed Type (X Type)	70
3-10. Removing the Wall Fixture from the Unit		7-5. Indicator Section Installation	
3-11. Selecting and Making a Hole		7-6. Operating Controller Installation	
3-12. Installing the Rear Panel on the Wall		■ Ceiling-Mounted Type (T Type)	71
3-13. Removing the Grille to Install the Indoor Unit		7-7. Indicator Section Installation	
3-14. Preparing the Indoor Side Tubing		7-8. Operating Controller Installation	
3-15. Wiring Instructions		7-9. Electrical Wiring	
3-16. Wiring Instructions for Inter-Unit Connections		7-10. Test Run Switch	
3-17. Shaping the Tubing		7-11. Misoperation Alarm Indicators	
3-18. Installing the Drain Hose			
■ Ceiling-Mounted Type (T Type)	47		
3-19. Suspending the Indoor Unit			
3-20. Duct for Fresh Air			
3-21. Installing the Drain Piping			

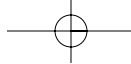

Page

<RCS-BH80UA.WL>

- 7-12. Separate Type Signal Receiving Unit Installation
- 7-13. Electrical Wiring
- 7-14. Test Run Switch
- 7-15. Misoperation Alarm Indicators
- 7-16. Basic Wiring Diagram
- 7-17. Wiring System Diagram for Group Control
- 7-18. Wiring System Diagram for Multiple Remote Controllers

<RCS-SH1UA>

- 7-19. Test Run Procedure
- 7-20. Check Items Before the Test Run
- 7-21. Preparing for the Test Run
- 7-22. Precautions
- 7-23. When Setting Indoor Unit Control PCB Switch for Wall-Mounted Indoor Unit

8. HOW TO INSTALL THE SYSTEM CONTROLLER (OPTIONAL PART) 85

- 8-1. System Controller Installation
- 8-2. Electrical Wiring
- 8-3. Address Switch Setting
- 8-4. Mode Setting
- 8-5. How to Perform Zone Registration
- 8-6. Connection with Other Equipment
- 8-7. Memory Back Up Switch
- 8-8. Test Run

9. HOW TO PROCESS TUBING 97

- 9-1. Connecting the Refrigerant Tubing
- 9-2. Connecting Tubing between Indoor and Outdoor Units
- 9-3. Insulating the Refrigerant Tubing
- 9-4. Taping the Tubes
- 9-5. Finishing the Installation

10. LEAK TEST, EVACUATION AND ADDITIONAL REFRIGERANT CHARGE 101

- 10-1. Leak Test
- 10-2. Evacuation
- 10-3. Charging Additional Refrigerant
- 10-4. Finishing the Job

11. TEST RUN 104

- 11-1. Preparing for Test Run
- 11-2. Caution
- 11-3. Test Run Procedure
- 11-4. Items to Check Before the Test Run
- 11-5. Test Run Using the Remote Controller
- 11-6. Precautions
- 11-7. Table of Self-Diagnostic Functions and Corrections (X, T, U, K Type)
- 11-8. Examples of Wiring Diagrams

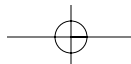

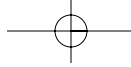

1. GENERAL

This booklet briefly outlines where and how to install the air conditioning system. Please read over the entire set of instructions for the indoor and outdoor units and make sure all accessory parts listed are with the system before beginning.

1-1. Tools Required for Installation (not supplied)

1. Standard screwdriver
2. Phillips head screwdriver
3. Knife or wire stripper
4. Tape measure
5. Level
6. Sabre saw or key hole saw
7. Hacksaw
8. Core bits
9. Hammer
10. Drill
11. Tube cutter
12. Tube flaring tool
13. Torque wrench
14. Adjustable wrench
15. Reamer (for deburring)

1-2. Accessories Supplied with Outdoor Unit

See Tables 1-1 to 1-9.

Table	Type
1-1	4-Way Air Discharge Semi-Concealed
1-2	Wall-Mounted
1-3	Ceiling-Mounted
1-4	Concealed-Duct
1-5	Outdoor Unit
1-6	Wired Remote Controller
1-7	Wireless Remote Controller
1-8	Timer Remote Controller
1-9	System Controller

1-3. Type of Copper Tube and Insulation Material

Copper tubing for connecting the outdoor unit to the indoor unit is available in kits which contain the liquid and gas tubing, fittings and insulation. Consult your nearest sales outlet or A/C workshop.

If you wish to purchase these materials separately from a local source, you will need:

1. Deoxidized annealed copper tube for refrigerant tubing.
2. Foamed polyethylene insulation for copper tubes as required to precise length of tubing. Wall thickness of the insulation should be not less than 5/16 in.
3. Use insulated copper wire for field wiring. Wire size varies with the total length of wiring. Refer to Section 5. "Electrical Wiring" for details.



CAUTION

Check local electrical codes and regulations before obtaining wire. Also, check any specified instructions or limitations.

1-4. Additional Materials Required for Installation

1. Refrigeration (armored) tape
2. Insulated staples or clamps for connecting wire (See your local codes.)
3. Putty
4. Refrigeration tubing lubricant
5. Clamps or saddles to secure refrigerant tubing
6. Scale for weighing

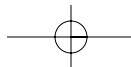

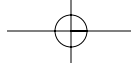
**Table 1-1 XH / XHW (4-Way Air Discharge Semi-Concealed)**

Part Name	Figure	Q'ty	Remarks
Full-scale installation diagram		1	For determining suspension bolt pitch
Flare insulator		2	For gas and liquid tubes
Washer		8	For suspending indoor unit from ceiling
Insulating tape	(White)	1	For gas tube flare nuts
Hose band		2	For securing drain hose
Packing		1	For drain joint
Drain insulator		1	For drain joint
Drain hose		1	
Drain hose adaptor		1	For drain outlet
Sealing putty		1	For sealing recessed portion of power supply
Tube connector		1	For sizing up of liquid tube from 1/4 in. to 3/8 in. (only for 26 type)
Wired remote controller (comes with 7-7/8 in. wire)		1	For XHW type
Wood screws		2	For XHW type
Wire joints		2	For XHW type
Owner's Manual		1	For XHW type
Installation Instructions		1	For XHW type

Table 1-2 KH / KHS (Wall-Mounted)

Part Name	Figure	Q'ty	Remarks
Wall fixture ^{*1}		1	For supporting indoor unit
Insulator ^{*1}		1	For insulation of tubing of the indoor unit
Mounting plate ^{*1}		1	For securing indoor unit
Tapping screw ^{*1}	Truss-head Phillips 4 x 1 in.	20	For attaching wall fixture
Full-scale diagram		1	For determining location where indoor unit is installed
Wall fixture ^{*2}		1	For supporting indoor unit
Rawl plug ^{*2}		10	For attaching wall fixture
Cover ^{*2}		1	For improved tubing appearance
Tapping screw ^{*2}	Truss-head Phillips 4 x 5/8 in.	10	For attaching wall fixture
Insulator		1	For insulation of tubing of indoor unit
Tube connector		1	For sizing up of liquid tube from 1/4 in. to 3/8 in. (only for 26 type)
L shape tube connector ^{*2}		1	Simplifies on-site tubing work
Wireless remote controller		1	For KHS type
Wireless remote controller mounting cradle		1	For KHS type
Truss-head tapping screws 4 x 5/8 in.		2	For KHS type
Batteries		2	For KHS type

*1 KH(S)3672R

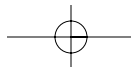
*2 KH(S)3072R
KH(S)3672R

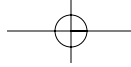
**Table 1-3 TH / THW (Ceiling-Mounted)**

Part Name	Figure	Q'ty	Remarks
Special washer		4	For temporarily suspending indoor unit from ceiling
Drain insulator		1	For drain hose joint
Flare insulator		1 Set	For gas tube joints
Drain hose adaptor		1	
Drain hose clamp		4	
Insulating tape	Black	2	For gas tube and drain hose joint
	White (heat-resisting)	1	For gas flare joints
Vinyl clamp		2	For ends of flare insulator
Full-scale installation diagram		1	For determining suspension bolt pitch
Sealing putty		1	For sealing recessed portion of power supply
Drain hose		1	
Tube connector		1	For sizing up of liquid tube from 1/4 in. to 3/8 in. (only for 26 type)
Wired remote controller (comes with 7-7/8 in. wire)		1	For THW type
Wood screws		2	For THW type
Wire joints		2	For THW type
Owner's Manual		1	For THW type
Installation Instructions		1	For THW type

Table 1-4 UH / UHW (Concealed-Duct)

Part Name	Figure	Q'ty	Remarks
Flare insulator		2	For gas and liquid tubes
Insulating tape	(Black)	2	For gas and liquid tubes
	(White)	2	For gas and liquid tube flare nuts
Tapping screw TOTA4-10		14 or 20 or 24	For air intake duct connection
Jumper cable*		1	For increasing fan speed
Hose band		1	For securing drain hose
Packing		1	For drain joint
Sealing putty		1	For sealing recessed portion of power supply
Drain insulator		1	For drain joint
Drain hose		1	
Drain hose adaptor		1	
Clamp		9	For securing drain hose & refrigerant tubing
Tube connector		1	For sizing up of liquid tube from 1/4 in. to 3/8 in. (only for 26 type)
Wired remote controller (comes with 7-7/8 in. wire)		1	For UHW type
Wood screws		2	For UHW type
Wire joints		2	For UHW type
Owner's Manual		1	For UHW type
Installation Instructions		1	For UHW type

* Jumper cable is housed inside the electrical component box.

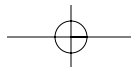

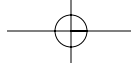

Table 1-5 (Accessories for the Wired Remote Controller)















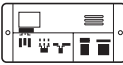

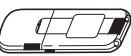

Part Name	Figure	Q'ty	Part Name	Figure	Q'ty
Wired remote controller (comes with 7-7/8 in. wire)		1	Spacers		2
Machine screws M4 x 1 in.		2	Wire joints		4
Wood screws		2			

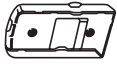
Table 1-6 (Accessories for the Wireless Remote Controller)

<RCS-SH80UA.WL>

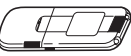
Part Name	Figure	Q'ty	Part Name	Figure	Q'ty
Operation controller		1	Spacers		2
Indicator section		1	Pan-head tapping screws 4 x 13/32 in.		4
Wireless remote controller		1	Truss-head tapping screws 4 x 5/8 in.		2
Wireless remote controller mounting cradle		1	Vinyl clamps L 5-29/32		3
Batteries		2	Wire joints		4

<RCS-SH1UA>

Part Name	Figure	Q'ty	Part Name	Figure	Q'ty
Wireless remote controller		1	Truss-head tapping screws 4 x 5/8 in.		2
Wireless remote controller mounting cradle		1	Batteries		2

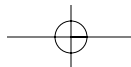

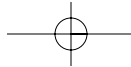

<RCS-BH80UA.WL>











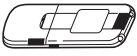

Part Name	Figure	Q'ty	Part Name	Figure	Q'ty
Separate type signal receiving unit (comes with 7-7/8 in. wire)		1	Small screws M4 x 1-9/16 in.		2
Carrier for ceiling installation		1	Wood screws		2
Wireless remote controller		1	Spacers		4
Wireless remote controller mounting cradle		1	Wire joints		4
Batteries		2	Clamp		1
Machine screws M4 x 1 in.		2	Ceiling installation paper pattern (3-3/4 x 2-1/32 in.)		1

Table 1-7 (Accessories for the Timer Remote Controller)

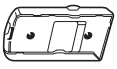









Part Name	Figure	Q'ty	Part Name	Figure	Q'ty
Timer Remote Controller		1	Wood screws		2
Connecting wiring length 4 ft.		1	Spacers		2
Machine screws M4 x 1 in.		2	Clamps		2

Table 1-8 (Accessories for the System Controller)

Part Name	Figure	Q'ty	Part Name	Figure	Q'ty
System controller		1	Label (Identification label)		1
Rubber bushing (7/8 in.)		4	Label (Terminal base label)		1
Screws for fixture (1-3/16 in.)		2			



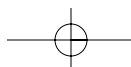
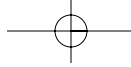

1-5. Tubing Size

Single type

- Refrigerant tubing between the indoor and outdoor units should be kept as short as possible.
- The length of the refrigerant tubes between the indoor and outdoor units are limited by the elevation difference between the 2 units. During tubing work, try to make both the tubing length (L) and the difference in elevation (H1) as short as possible. Refer to Table 1-10.

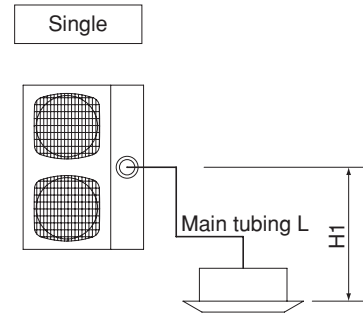
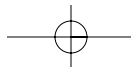

Table 1-9

Indoor unit type	26, 30, 36 types	42 type
Maximum length	165 ft.	165 ft.
Charge-less tubing length (actual length)	10 – 100 ft.	15 – 100 ft.
Additional charge per 1 ft.	0.43 oz.	

Maximum indoor-outdoor height difference	If outdoor unit is higher	H1	≤ 100
	If outdoor unit is lower	H1	≤ 50



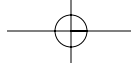

Table 1-10 Tubing Data for Models

Tubing Data		Models	C(H)2672R	C(H)3072R C(H)3672R	C(H)4272R
		Tubing size	Liquid tube in. (mm)	3/8 (9.52)	3/8 (9.52)
outer diameter	Gas tube in. (mm)	5/8 (15.88)	5/8 (15.88)	5/8 (15.88)	
Limit of tubing length	(ft.)	165	165	165	
Limit of elevation difference between the 2 units	Outdoor unit is placed higher (ft.)	100	100	100	
	Outdoor unit is placed lower (ft.)	50	50	50	
Max. allowable tubing length at shipment	(ft.)	10 – 100	10 – 100	10 – 100	
Required additional refrigerant *1	(oz./ft.)	a) 0.43	b) 0.43	b) 0.43	
Refrigerant charged at shipment	(lbs.)	4.2	6.2	7.9	

No additional charge of compressor oil is necessary.

*1 If total tubing length becomes 100 to 165 ft., charge additional refrigerant by 0.43 oz./ft.

Table 1-11 List of Connection Tube Sizes

	Main tubing (L)
Type capacity of indoor units	26 – 42
Gas tube	ø5/8"
Liquid tube	ø3/8"
Amount of additional charge per 1 ft.	0.43 oz.

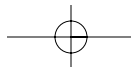

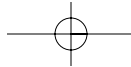

CAUTION

1. This unit requires no additional refrigerant charge up to 100 ft. tubing length. In case of more than 100 ft., additional refrigerant charge is required. Refer to Table 1-11.
2. In case of multi type installation, indoor units should be installed within the same room. If multi type indoor units are installed in different rooms, temperature control may develop problems because thermostat operation must follow the thermostat condition of 1 indoor unit only (the main unit).



WARNING

Always check the gas density for the room in which the unit is installed.

■ Check of limit density

When installing an air conditioner in a room, it is necessary to ensure that even if the refrigerant gas accidentally escapes, its density does not exceed the limit level. If the density might exceed the limit level, it is necessary to set up an opening between it and the adjacent room, or to install mechanical ventilation which is interlocked with the leak detector.

(Total refrigerant charged amount: oz.)

(Min indoor volume where the indoor unit is installed: ft.³)
 \leq Limit density 0.3 (oz./ft.³)

The limit density of refrigerant which is used in this unit is 0.3 oz./ft.³ (ISO 5149).

The shipped outdoor unit comes charged with the amount of refrigerant fixed for each type; so add it to the amount that is charged at the field. (For the refrigerant charge amount at shipment, refer to the unit's nameplate.)

Minimum indoor volume & floor area relative to the amount of refrigerant is roughly as given in the following table.

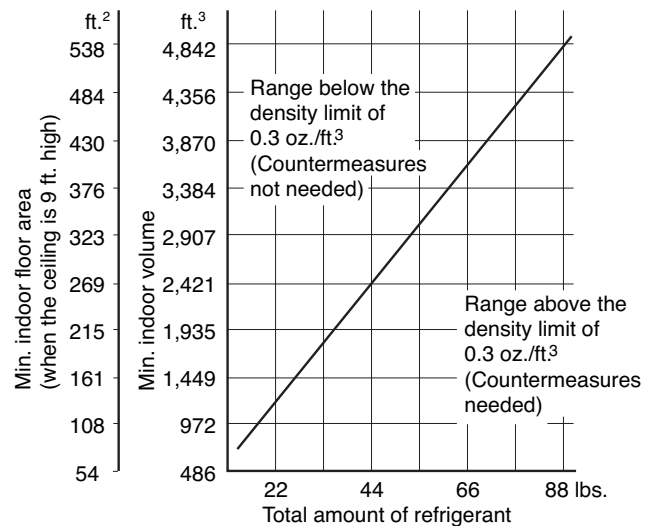

CAUTION

Pay special attention to any location, such as a basement or recessed area, etc. where leaked refrigerant can collect, since refrigerant gas is heavier than air.

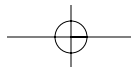

2. SELECTING THE INSTALLATION SITE

2-1. Indoor Unit

AVOID:

- areas where leakage of flammable gas may be expected.
- places where large amounts of oil mist exist.
- direct sunlight.
- locations near inverter lamps which may affect the performance of the unit.
- locations near heat sources which may affect the performance of the unit.
- locations where external air may enter the room directly. This may cause "sweating" on the air discharge ports, causing them to spray or drip.
- locations where the remote controller will be splashed with water or affected by dampness or humidity.
- installing the remote controller behind curtains or furniture.
- locations where the receiver in the indoor unit is exposed to the inverter lamp light. Faulty operation of the unit occurs.

DO:

- select an appropriate position from which every corner of the room can be uniformly cooled.
- select a location where the ceiling is strong enough to support the weight of the unit.
- select a location where tubing and drain pipe have the shortest run to the outdoor unit.
- allow room for operation and maintenance as well as unrestricted air flow around the unit.
- install the unit within the maximum elevation difference above or below the outdoor unit and within a total tubing length (L) from the outdoor unit as detailed in Table 1-11.
- allow room for mounting the remote controller about 3 ft. off the floor, in an area that is not in direct sunlight nor in the flow of cool air from the indoor unit.

NOTE

Air delivery will be degraded if the distance from the floor to the ceiling is greater than 10 ft.

Ceiling-Mounted Type

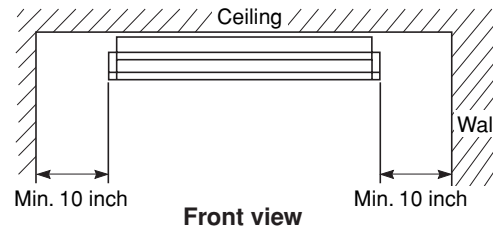

NOTE

The rear of the indoor unit can be installed flush against the wall.

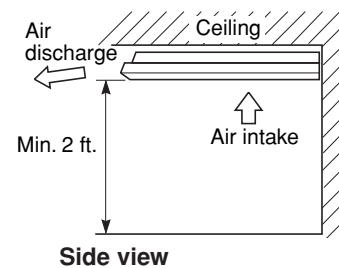

4-Way Air Discharge Type Concealed-Duct Type

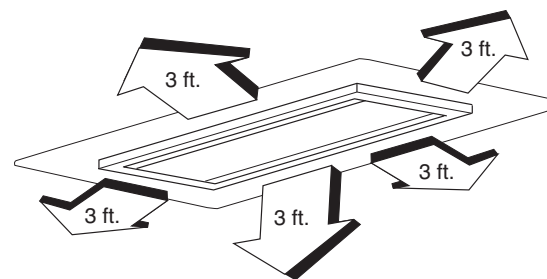

Wall-Mounted Type

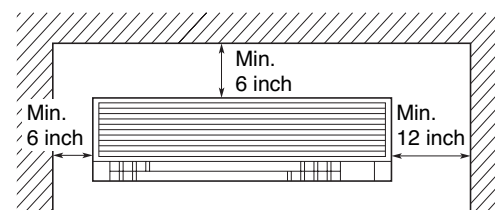

2-2. Outdoor Unit

AVOID:

- heat sources, exhaust fans, etc. (Fig. 2-1)
- damp, humid or uneven locations

DO:

- choose a place as cool as possible.
- choose a place that is well ventilated and outside air temperature does not exceed maximum 115°F constantly.
- allow enough room around the unit for air intake/exhaust and possible maintenance. (Fig. 2-2)
- use lug bolts or equal to bolt down unit, reducing vibration and noise.
- if cooling operation is to be used when the outdoor air temperature is 23°F or below, install a duct on the outdoor unit.

Installation space

Distance between obstructions and the unit air inlet and outlet must be as shown below.

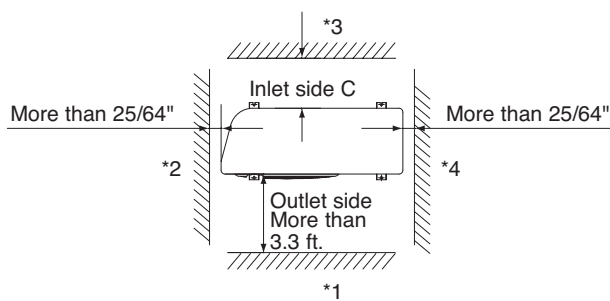

Fig. 2-2

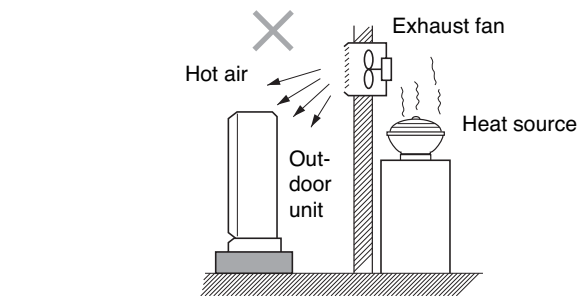

Fig. 2-1

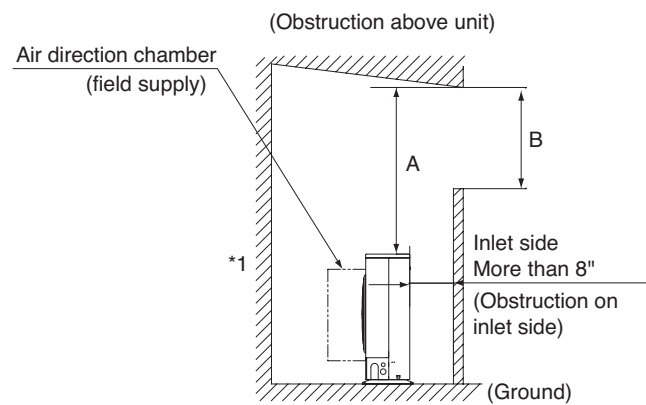

Fig. 2-3



CAUTION

- Concerning inlet-side distance "C" (Fig. 2-2) The minimum for distance "C" is 6" if there are no obstructions on the outlet side (wall *1 side) and *2 or *4 is not present. In all other cases, the minimum for distance "C" is 8".
- If the unit is installed with the outlet side facing wall *1, then there must be no obstructions on 2 of the remaining 3 sides: *2, *3, *4.
- If wall *1 is on the outlet side (Fig. 2-2), or if obstructions are present on all 3 sides *2, *3, and *4 (Fig. 2-2), then the minimum distance for "A" and "B" is 80" (Fig. 2-3). Even if there is no wall on the outlet side, a minimum of 3.3 ft. is required.

Installation requirements

- provide a solid base (concrete block, 4" × 16" beams or equal), a minimum of 6" above ground level to reduce humidity and protect the unit against possible water damage and decreased service life. (Fig. 2-4)
- use lug bolts or equal to bolt down unit, reducing vibration and noise.

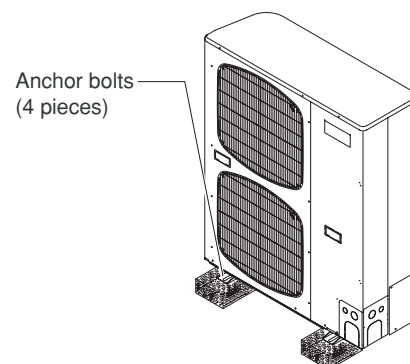

Fig. 2-4

2-3. Air-Discharge Chamber for Top Discharge

Be sure to install an air discharge chamber in the field when:

- it is difficult to keep a space of min. 20" between the air discharge outlet and an obstacle.
- the air discharge outlet is facing a sidewalk and discharged hot air may bother passers-by. Refer to Fig. 2-5.

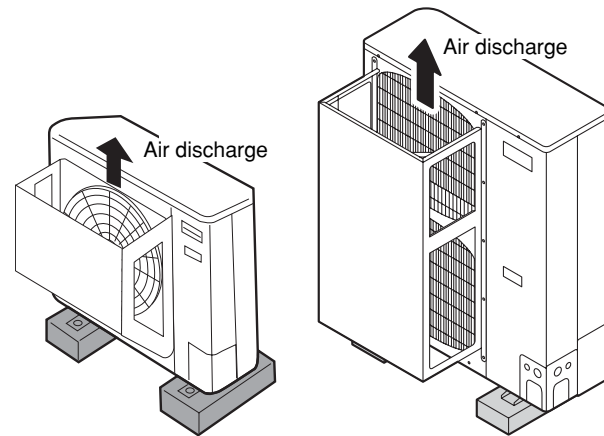

Fig. 2-5

In regions with significant snowfall, the outdoor unit should be provided with a platform and snow-proof duct.

2-4. Installing the Unit in Heavy Snow Areas

In locations with strong wind, snow-proof ducting should be fitted and direct exposure to the wind should be avoided as much as possible.

■ Countermeasures against snow and wind

In regions with snow and strong wind, the following problems may occur when the outdoor unit is not provided with a platform and snow-proof ducting:

- The outdoor fan may not run and damage to the unit may occur.
- There may be no air flow.
- The tubing may freeze and burst.
- The condenser pressure may drop because of strong wind, and the indoor unit may freeze.

2-5. Precautions for Installation in Heavy Snow Areas

- (1) The platform should be higher than the max. snow depth. (Fig. 2-6)
- (2) The 2 anchoring feet of the outdoor unit should be used for the platform, and the platform should be installed beneath the air intake side of outdoor unit.
- (3) The platform foundation must be firm and the unit must be secured with anchor bolts.
- (4) In case of installation on a roof subject to strong wind, countermeasures must be taken to prevent the unit from being blown over.

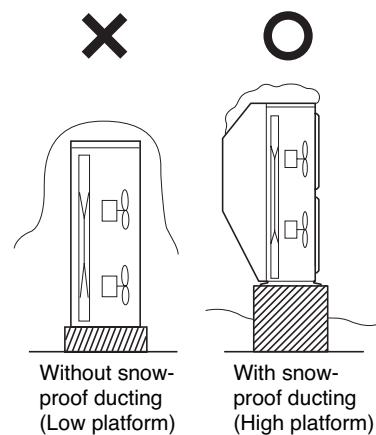

Fig. 2-6

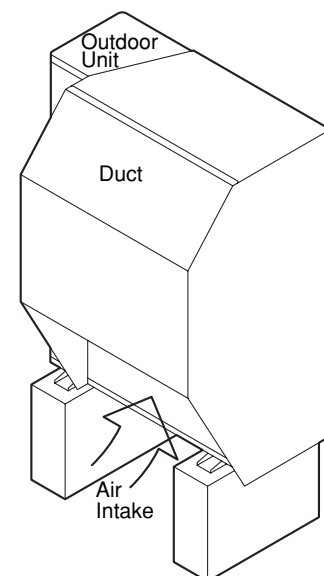
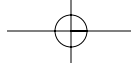

Fig. 2-7



2-6. Dimensions of Wind Ducting

Reference diagram for air-discharge chamber (field supply)

STK-DRV80U for 2672R / 3072R / 3672R unit

- | | |
|---|------------------------------|
| ① | Air discharge chamber |
| ② | Air discharge chamber (base) |

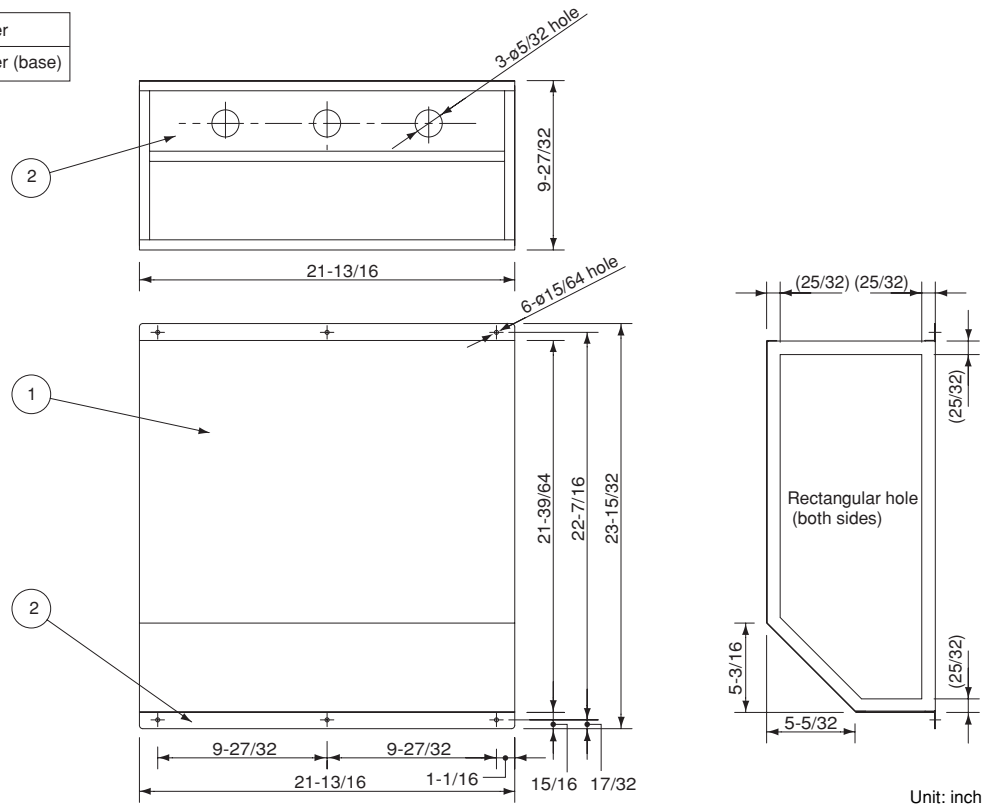

Unit: inch

Note: In snowy regions, if there is concern that snow may enter the air discharge chamber, remove the base of the chamber (10 screws) before using.

STK-DRE140A for 4272R unit

- | | |
|---|--|
| ① | Unit front, air discharge chamber |
| ② | Unit left side, air discharge chamber |
| ③ | Unit right side, air discharge chamber |
| ④ | Reinforcement brackets, 4 locations |

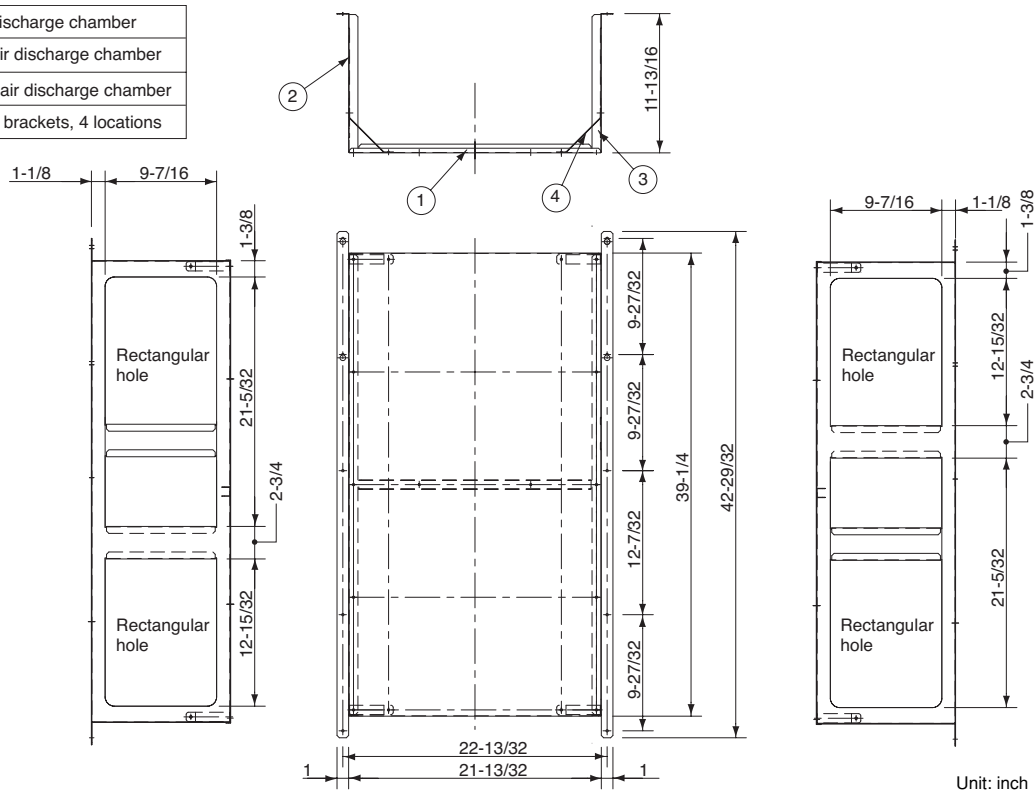

Unit: inch

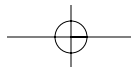

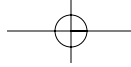

Dimensions of Outdoor Unit with air-discharge chamber (field supply)
2672R / 3072R / 3672R unit with STK-DRV80U

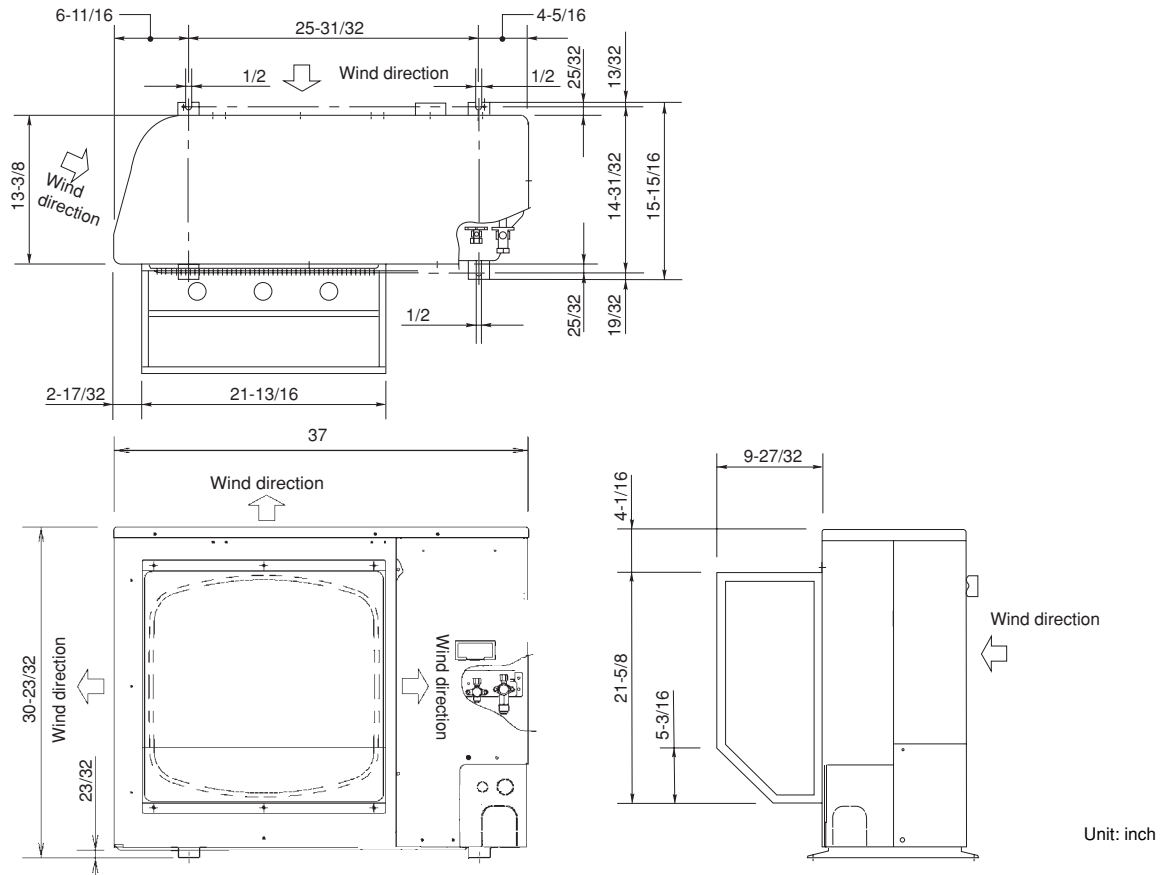

4272R unit with STK-DRE140A

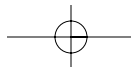
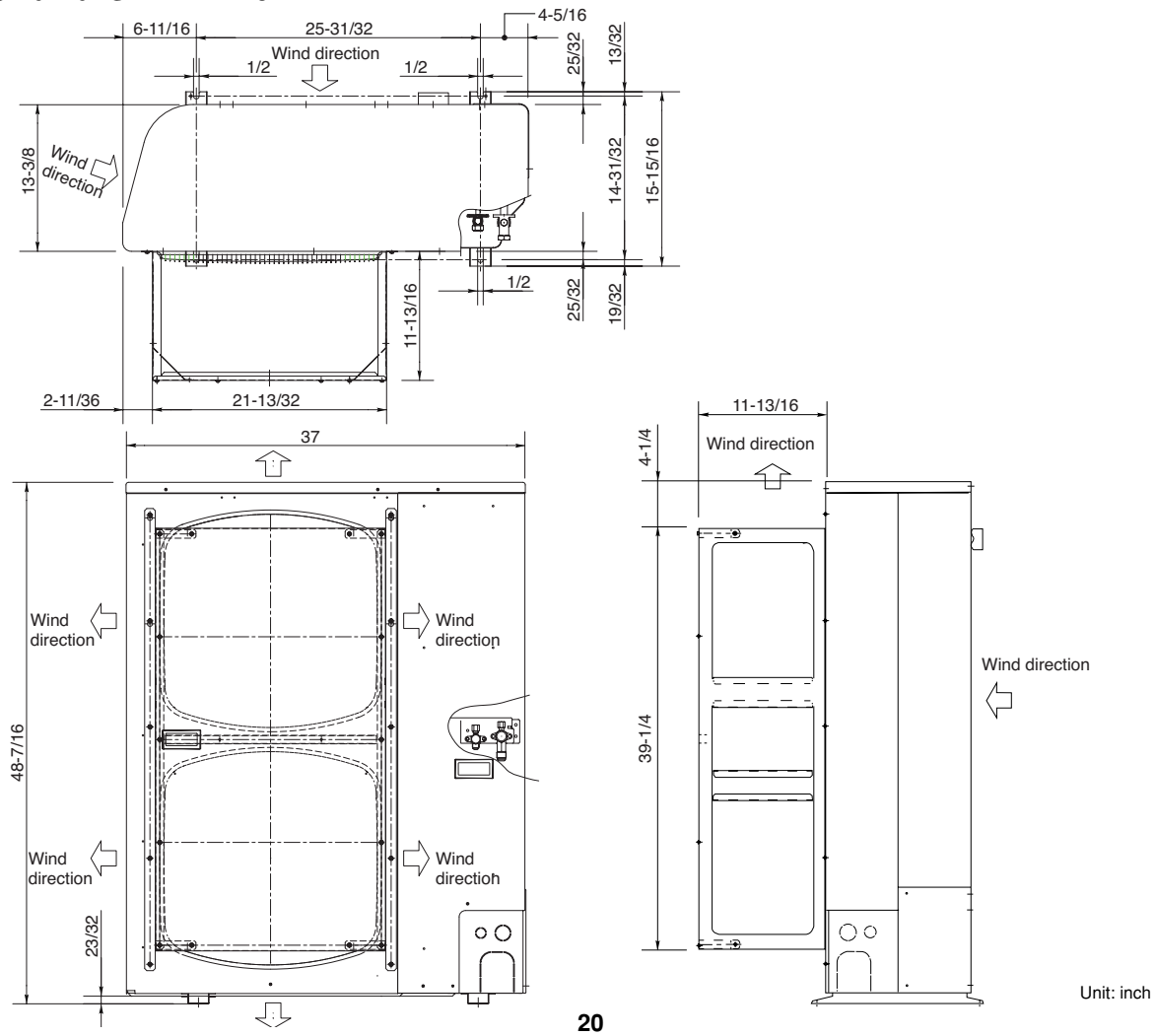

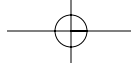

Reference diagram for air-discharge chamber (field supply)

C(H)2672R / 3072R / 3672R / 4272R with STK-DRV80U & DRE140A

Required space around outdoor unit

If the air discharge chamber is used, the space shown below must be secured around the outdoor unit.
 If the unit is used without the required space, a protective device may activate, preventing the unit from operating.

(1) Single-unit installation

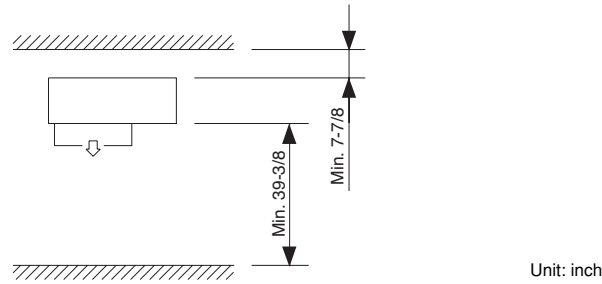

CAUTION

The top and both sides must remain open. If there are obstacles to the front and rear of the outdoor unit, the obstacle at either the front or rear must be no taller than the height of the outdoor unit.

(2) Multiple-unit installation

● Installation in lateral rows

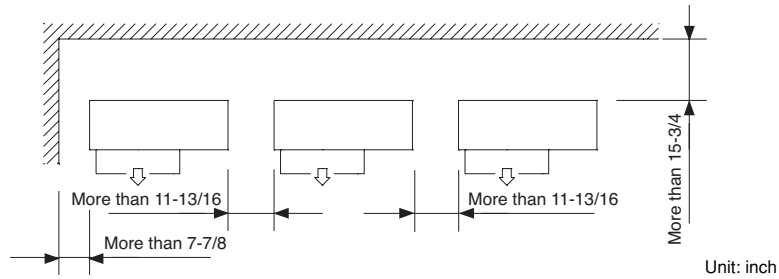

CAUTION

The front and top must remain open. The obstacles must be no taller than the height of the outdoor unit.

● Installation in front-rear rows

Installation with intakes facing outlets

Installation with intakes facing intakes or outlets facing outlets

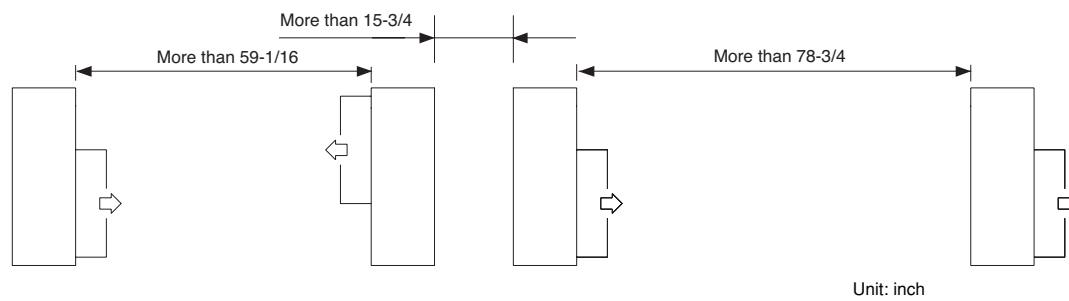

CAUTION

The front and both sides must remain open.

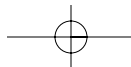

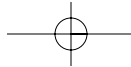

2-7. Dimensions of Snow Ducting

Reference diagram for snow-proof vents (field supply)

STK-BDRE80A for 2672R / 3072R / 3672R unit

①	Unit top, snow-proof vent
②	Unit left side
③	Unit right side
④	Unit reverse side
⑤	Unit reverse side
⑥	Unit sides, reinforcement brackets for snow-proof vent

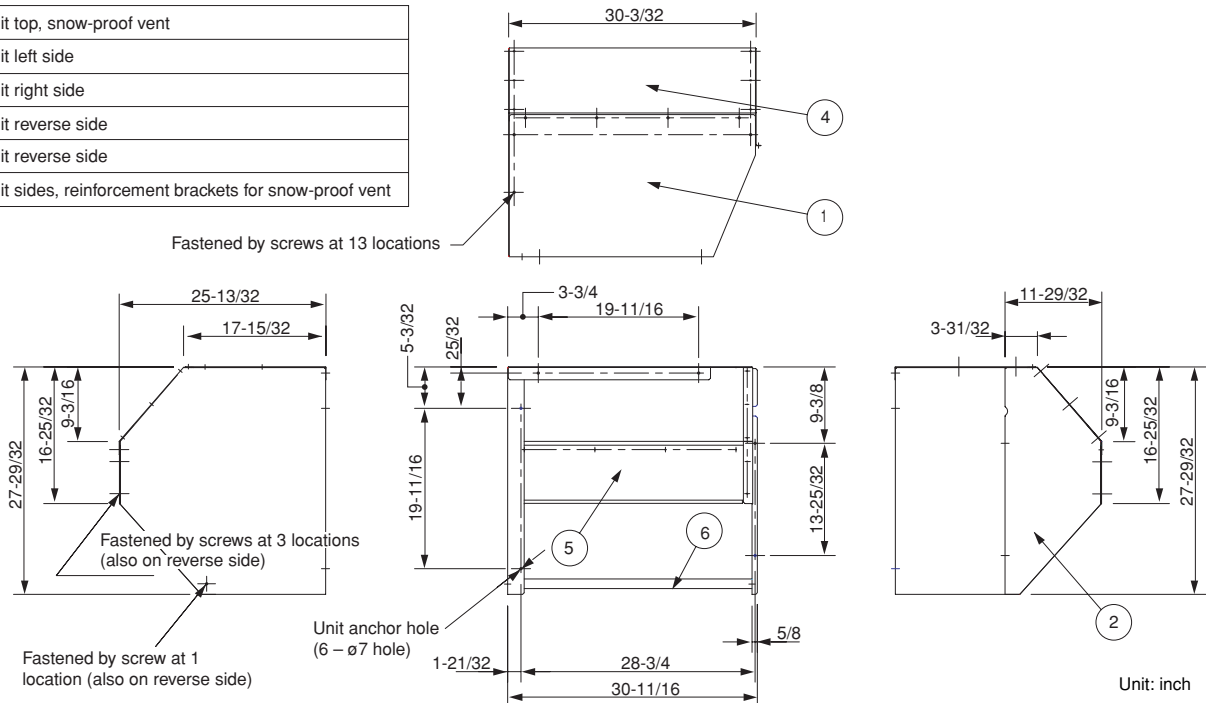

STK-BDR140U for 4272R unit

①	Unit top, snow-proof vent
②	Unit left side
③	Unit right side
④	Unit reverse side
⑤	Unit reverse side
⑥	Unit sides, reinforcement brackets for snow-proof vent

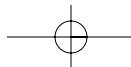
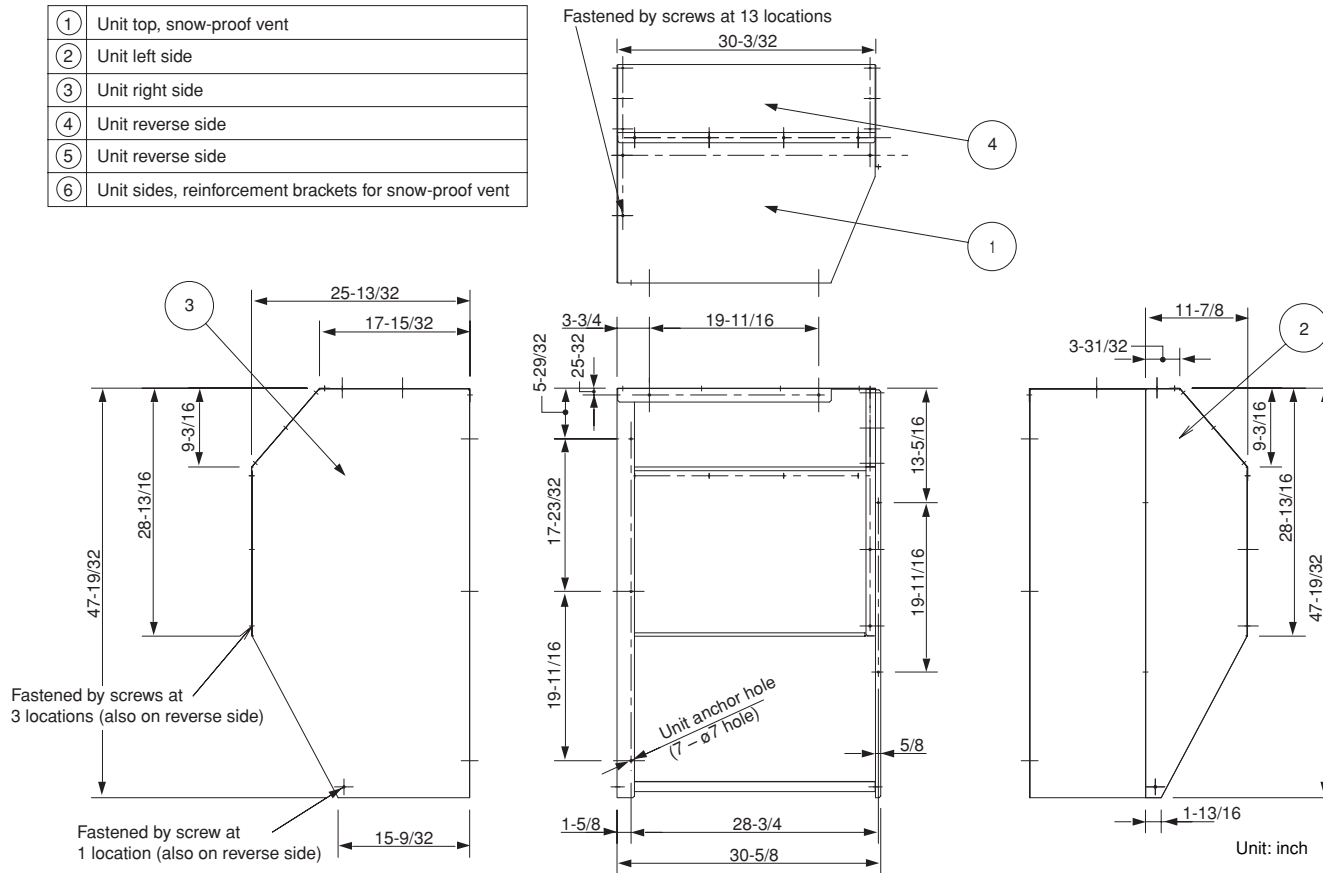

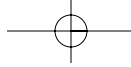

Dimensions of outdoor unit with snow-proof vents (field supply)

2672R / 3072R / 3672R unit with STK-BDRE80A

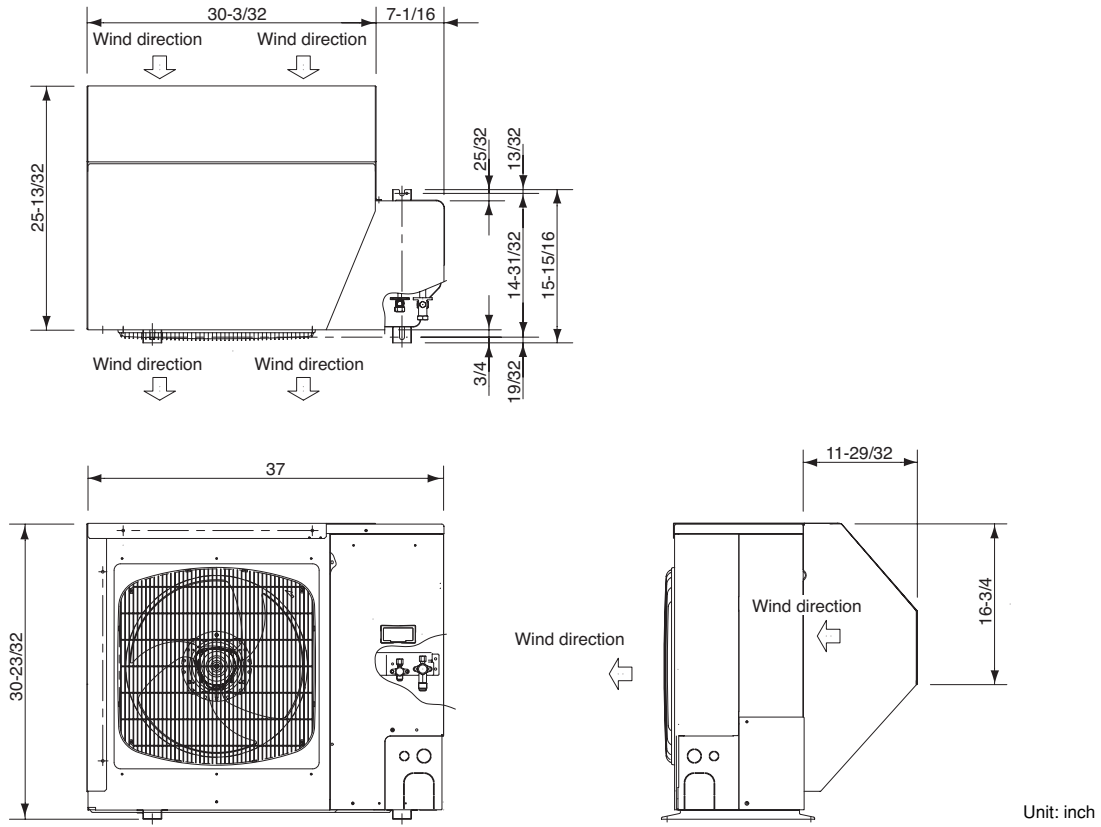

Unit: inch

4272R unit with STK-BDR140U

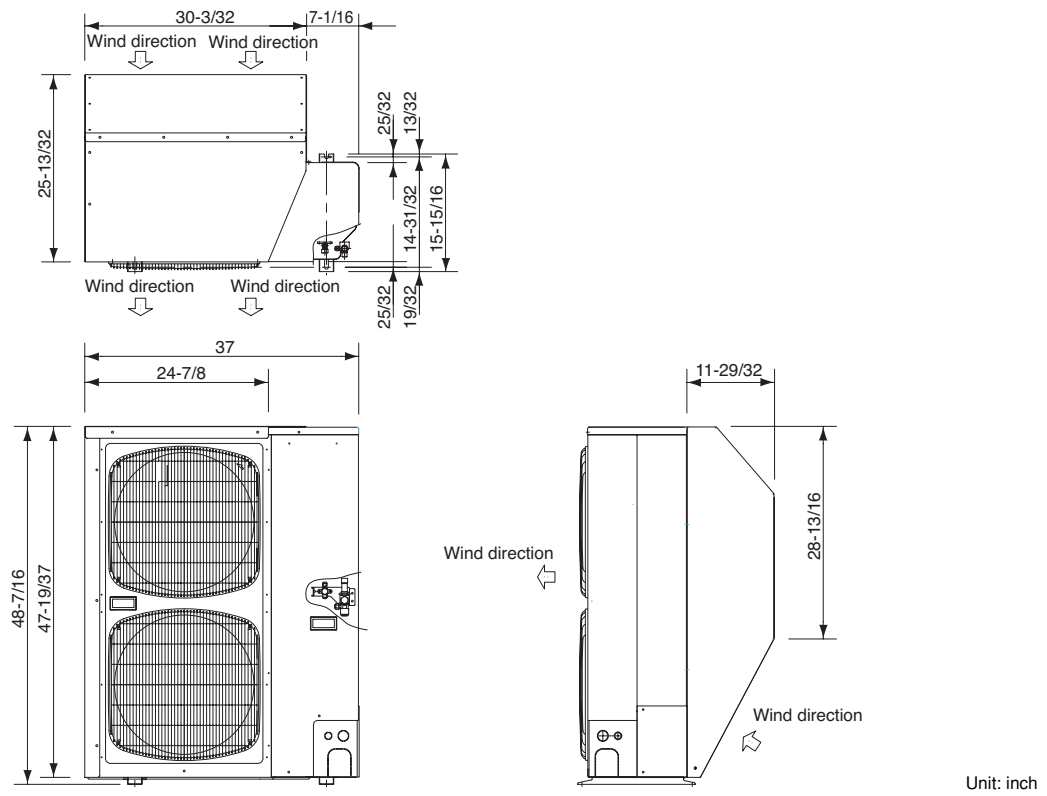

Unit: inch

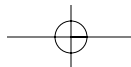

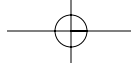

Reference diagram for snow-proof vents – 1

Space requirements for setting – (1)

C(H)2672R / 3072R / 3672R / 4272R with STK-BDRE80A & STK-BDR140U

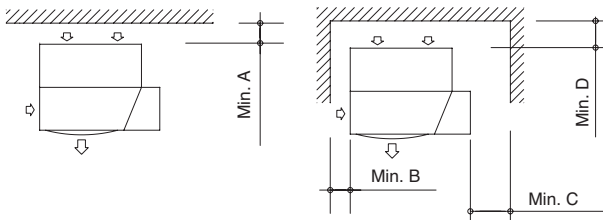
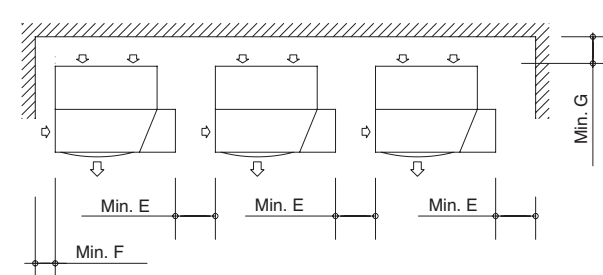
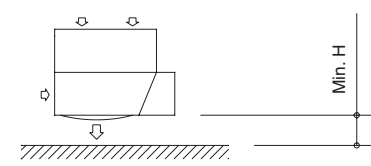
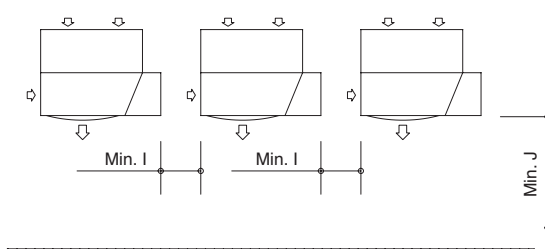
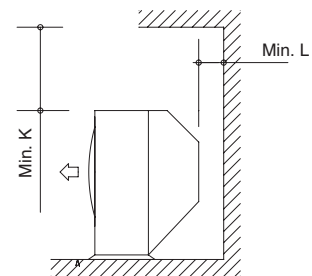
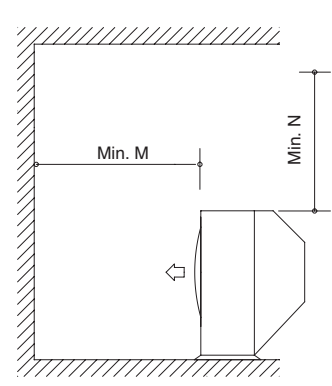
[Obstacle to the rear of unit]	[Obstacle to the front of unit]																																
<p>● Top is open:</p> <p>(1) Single-unit installation (2) Obstacles on both sides</p>  <p>(3) Multiple-unit installation (2 or more units)</p>  <table border="1" style="width: 100%; border-collapse: collapse; margin-top: 10px;"> <thead> <tr> <th style="width: 15%;">Outdoor unit</th> <th style="width: 65%;">C(H)2672R / 3072R / 3672R / 4872R</th> <th style="width: 20%;"></th> </tr> </thead> <tbody> <tr><td>A</td><td>5-29/32</td><td></td></tr> <tr><td>B</td><td>5-29/32</td><td></td></tr> <tr><td>C</td><td>11-13/16</td><td></td></tr> <tr><td>D</td><td>7-7/8</td><td></td></tr> <tr><td>E</td><td>11-13/16</td><td></td></tr> <tr><td>F</td><td>5-29/32</td><td></td></tr> <tr><td>G</td><td>7-7/8</td><td></td></tr> </tbody> </table> <p>Note: In cases 2 and 3 the height of the obstacle must be no taller than the height of the outdoor unit.</p>	Outdoor unit	C(H)2672R / 3072R / 3672R / 4872R		A	5-29/32		B	5-29/32		C	11-13/16		D	7-7/8		E	11-13/16		F	5-29/32		G	7-7/8		<p>● Top is open:</p> <p>(1) Single-unit installation</p>  <p>(2) Multiple-unit installation (2 or more units)</p>  <table border="1" style="width: 100%; border-collapse: collapse; margin-top: 10px;"> <thead> <tr> <th style="width: 30%;">Outdoor unit</th> <th style="width: 15%;">H</th> <th style="width: 15%;">I</th> <th style="width: 15%;">J</th> </tr> </thead> <tbody> <tr> <td>C(H)2672R / 3072R / 3672R / 4272R</td> <td>19-11/16</td> <td>11-13/16</td> <td>39-3/8</td> </tr> </tbody> </table>	Outdoor unit	H	I	J	C(H)2672R / 3072R / 3672R / 4272R	19-11/16	11-13/16	39-3/8
Outdoor unit	C(H)2672R / 3072R / 3672R / 4872R																																
A	5-29/32																																
B	5-29/32																																
C	11-13/16																																
D	7-7/8																																
E	11-13/16																																
F	5-29/32																																
G	7-7/8																																
Outdoor unit	H	I	J																														
C(H)2672R / 3072R / 3672R / 4272R	19-11/16	11-13/16	39-3/8																														
<p>● Top is blocked by an obstacle:</p>  <table border="1" style="width: 100%; border-collapse: collapse; margin-top: 10px;"> <thead> <tr> <th style="width: 30%;">Outdoor unit</th> <th style="width: 15%;">L</th> <th style="width: 15%;">K</th> </tr> </thead> <tbody> <tr> <td>C(H)2672R / 3072R / 3672R / 4272R</td> <td>19-11/16</td> <td>5-29/32</td> </tr> </tbody> </table>	Outdoor unit	L	K	C(H)2672R / 3072R / 3672R / 4272R	19-11/16	5-29/32	<p>● Top is blocked by an obstacle:</p>  <table border="1" style="width: 100%; border-collapse: collapse; margin-top: 10px;"> <thead> <tr> <th style="width: 50%;">Outdoor unit</th> <th style="width: 25%;">M</th> <th style="width: 25%;">N</th> </tr> </thead> <tbody> <tr> <td>C(H)2672R / 3072R / 3672R / 4272R</td> <td>39-3/8</td> <td>39-3/8</td> </tr> </tbody> </table>	Outdoor unit	M	N	C(H)2672R / 3072R / 3672R / 4272R	39-3/8	39-3/8																				
Outdoor unit	L	K																															
C(H)2672R / 3072R / 3672R / 4272R	19-11/16	5-29/32																															
Outdoor unit	M	N																															
C(H)2672R / 3072R / 3672R / 4272R	39-3/8	39-3/8																															

Unit: inch

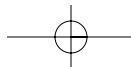

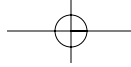

Reference diagram for snow-proof vents – 2

Space requirements for setting – (2)

C(H)2672R / 3072R / 3672R / 4272R with STK-BDRE80A & STK-BDR140U

[Obstacles to the front and rear of unit]

- The top and both sides must remain open. Either the obstacle to the front or the obstacle to the rear must be no taller than the height of the outdoor unit.

(1) Single-unit installation

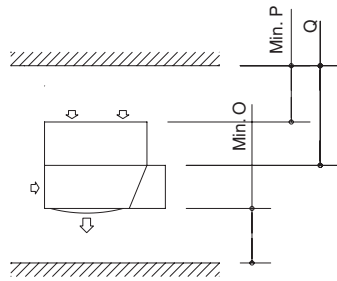

Dimension Q

If a snow protection duct is attached after the unit is installed, verify that dimension Q is 19-11/16 in. or more.

Outdoor unit	O	P
C(H)2672R / 3072R / 3672R / 4272R	39-3/8	5-29/32

(2) Obstacles on both sides

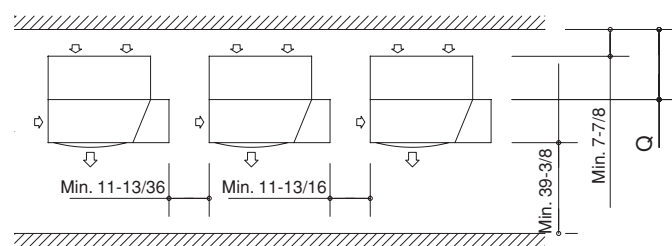

[Installation in front-rear rows]

- The top and both sides must remain open. Either the obstacle to the front or the obstacle to the rear must be no taller than the height of the outdoor unit.

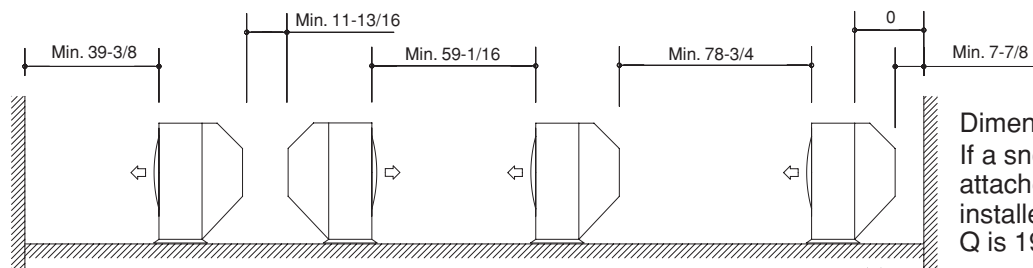

Dimension Q

If a snow protection duct is attached after the unit is installed, verify that dimension Q is 19-11/16 in. or more.

Unit: inch

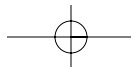

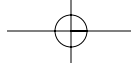

3. HOW TO INSTALL THE INDOOR UNIT

■ 4-Way Air Discharge Semi-Concealed Type (X Type)

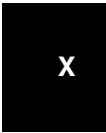

3-1. Suspending the Indoor Unit

This unit uses a drain pump. Use a carpenter's level to check that the unit is level.

3-2. Preparation for Suspending

- Fix the suspension bolts securely in the ceiling using the method shown in the diagrams (Figs. 3-1 and 3-2), by attaching them to the ceiling support structure, or by any other method that ensures that the unit will be securely and safely suspended.
- Follow Fig. 3-2 and Table 3-1 to make the holes in the ceiling.

Table 3-1 Unit: inch (mm)

Type	Length	A	B
XH(W)2672R (PNR-XH2442)		32-9/32 (820)	22-9/32 (566)
XH(W)3672R, XH(W)4272R (PNR-XH3642)		43-11/16 (1,110)	33-11/16 (856)

- Determine the pitch of the suspension bolts using the supplied full-scale installation diagram. The diagram and table (Fig. 3-3 and Table 3-2) show the relationship between the positions of the suspension fitting, the unit, and the panel.

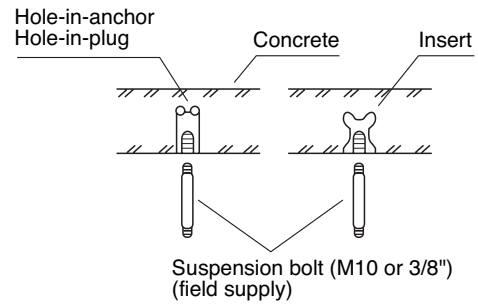

Fig. 3-1

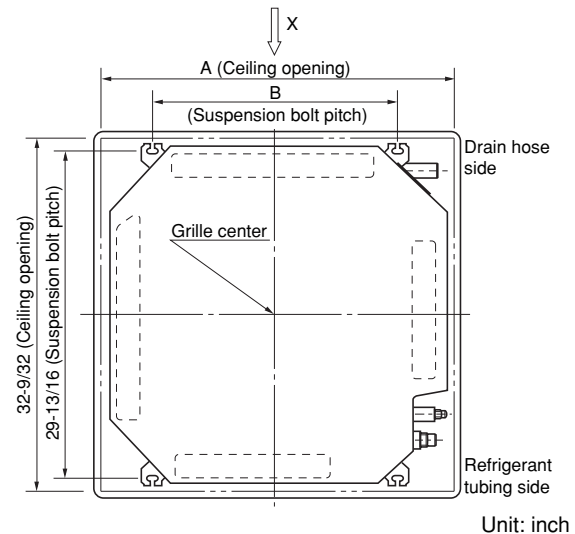

Fig. 3-2

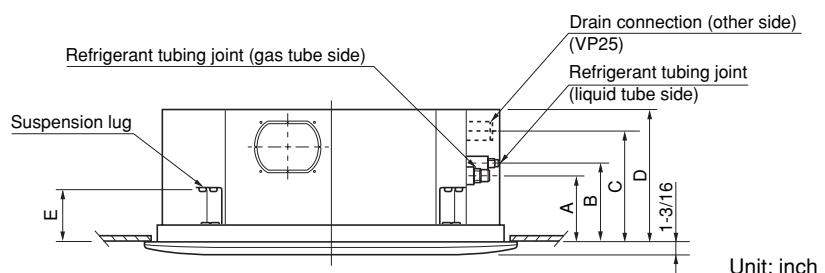
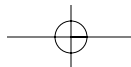

Fig. 3-3

Table 3-2

Unit: inch (mm)

Type	Length	A	B	C	D	E
XH(W)2672R (PNR-XH2442)		6-3/16 (157)	7-5/32 (182)	10-9/32 (261)	12-1/8 (308)	4-7/8 (124)
XH(W)3672R, XH(W)4272R (PNR-XH3632)		6-3/16 (157)	7-5/32 (182)	11-15/32 (291)	13-1/16 (338)	4-7/8 (124)



3-3. Placing the Unit Inside the Ceiling

- (1) When placing the unit inside the ceiling, determine the pitch of the suspension bolts using the supplied full-scale installation diagram. (Fig. 3-4) The size of the opening for the indoor unit can be confirmed by attaching the full-scale installation diagram beneath the unit. (Fig. 3-4) Tubing and wiring must be laid inside the ceiling when suspending the unit. If the ceiling is already constructed, lay the tubing and wiring into position for connection to the unit before placing the unit inside the ceiling.
- (2) The length of each suspension bolt must be appropriate for a distance between the bottom of the bolt and the bottom of the ceiling of 19/32 in. or more as shown in Fig. 3-4.
- (3) Thread the 2 hexagonal nuts (field supply) and washers onto the 4 suspension bolts as shown in Fig. 3-5. Use 2 sets of nuts and washers (upper and lower), so that the unit will not fall off the suspension lugs.
- (4) Remove the protective cardboard used to protect the fan parts during transport.
- (5) Adjust the distance between the unit and surface of the ceiling. (1-7/8 in.) (Fig. 3-4)

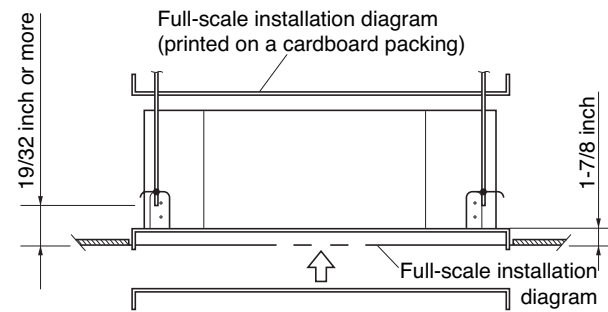

Fig. 3-4

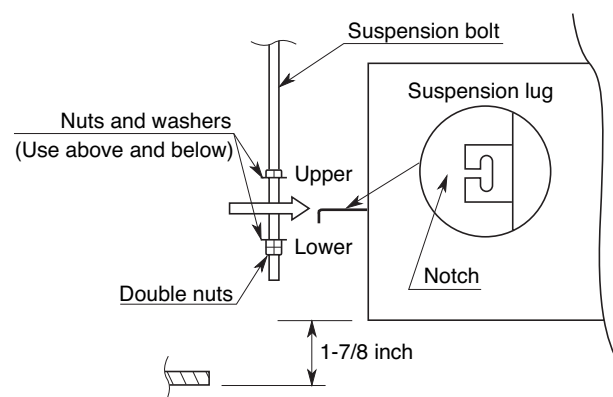

Fig. 3-5

X

3-4. Installing the Drain Piping

- (1) Prepare standard hard PVC pipe for the drain and use the supplied drain hose and hose band to prevent water leaks.

The PVC pipe must be purchased separately. The transparent part allows you to check drainage. (Fig. 3-6)



CAUTION

Tighten the hose clamps so their locking nuts face upward. (Fig. 3-6)

- (2) After checking the drainage, wrap the supplied packing and drain pipe insulator around the pipe. (Fig. 3-7)

NOTE

Ensure the drain pipe has a downward gradient (1/100 or more) and that there are no water traps.



CAUTION

- Do not install an air bleeder tube, as this may cause water to spray from the drain tube outlet. (Fig. 3-8)
- If it is necessary to increase the height of the drain pipe, the section directly after the connection port can be raised a maximum of 19-11/16 in. Do not raise it any higher than 19-11/16 in., as this could result in water leaks. (Fig. 3-9)
- Do not install the pipe with an upward gradient from the connection port. This will cause drain water to flow backwards and leak when the unit is stopped. (Fig. 3-10)
- Do not apply force to the piping on the unit side when connecting the drain pipe. The pipe should not be allowed to hang unsupported from its connection to the unit. Fasten the pipe to a wall, frame, or other support as close to the unit as possible. (Fig. 3-11)
- Provide insulation for any drain pipe that is run indoors.

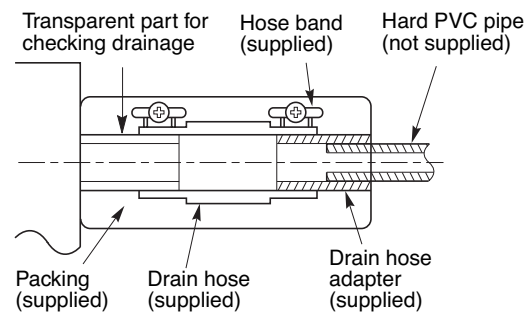

Fig. 3-6

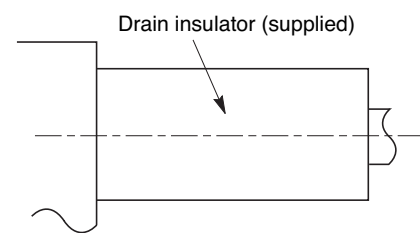

Fig. 3-7

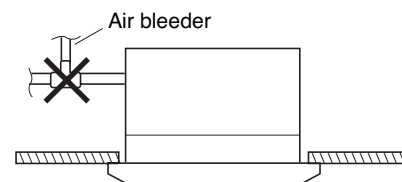

Fig. 3-8

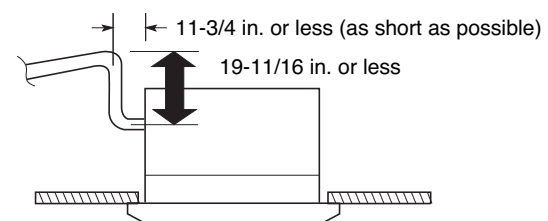

Fig. 3-9

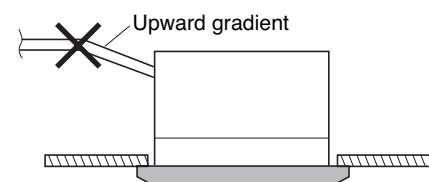

Fig. 3-10

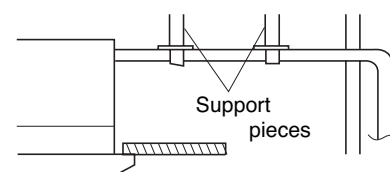

Fig. 3-11

3-5. Checking the Drainage

After wiring and piping are completed, use the following procedure to check that the water will drain smoothly. For this, prepare a bucket and wiping cloth to catch and wipe up spilled water.

WARNING

Do not supply power to the unit until the tubing and wiring to the outdoor unit are completed.

- (1) Take off the tube cover and through the opening, slowly pour about 43 oz. of water into the drain pan to check drainage.
- (2) Do Test Run to check the drainage after completing installation. When performing Test Run, be sure to observe the Test Run procedure. Refer to page 105.

CAUTION

Be careful since the fan will start turning when checking the drainage.

- (3) After drain checking is finished, return the Operation Selector switch to the RUN position (ON position) and remount the tube cover.

WARNING

To mount the tube cover, use 5/16" (4 × 8 mm) tapping screws. Do not use long screws as they may puncture the drain pan and cause water leakage.

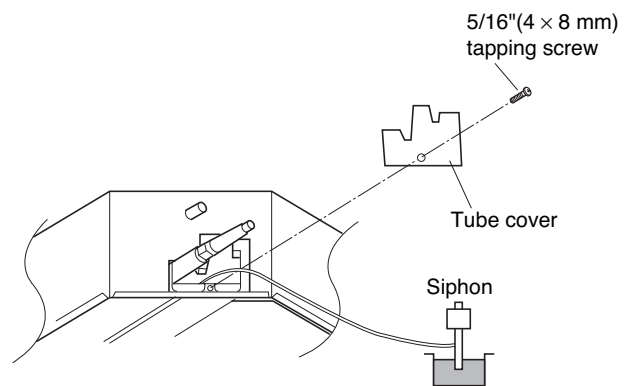
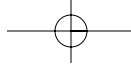

Fig. 3-12

X



■ Ceiling Panel



CAUTION

Never touch or attempt to move the air direction louver by hand or you may damage the unit. Instead, use the remote control unit if you want to change the direction or air flow.

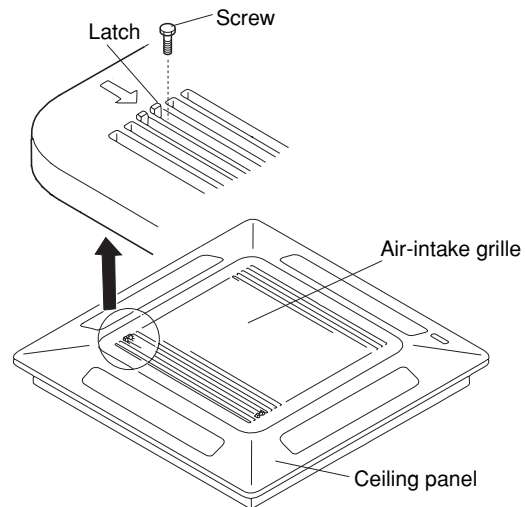
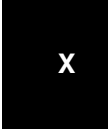

Fig. 3-13

3-6. Before Installing the Ceiling Panel

- (1) Remove the air-intake grille and air filter from the ceiling panel. (Figs. 3-13 and 3-14)
 - (a) Remove the 2 screws on the latch of the air-intake grille. (Fig. 3-13)
 - (b) Press on the 2 latches of the air-intake grille with your thumbs in the direction of the arrow to open the grille. (Fig. 3-13)
 - (c) With the air-intake grille open about 45°, remove the safety cord (hook on the grille side). (Fig. 3-14)
 - (d) Pull the air-intake grille towards you to remove it from the ceiling panel.
- (2) Pull down the two panel catches on the body of the indoor unit body. (Fig. 3-15)

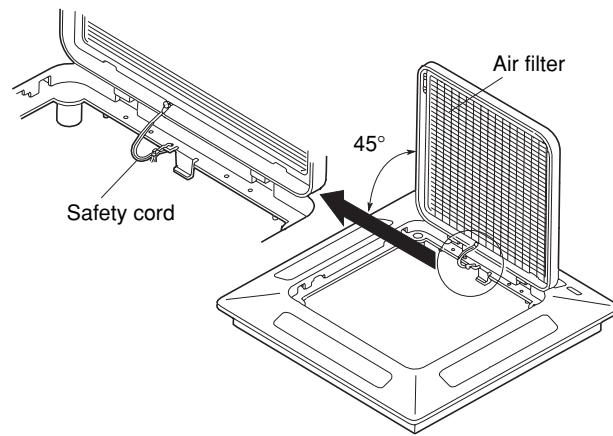

Fig. 3-14

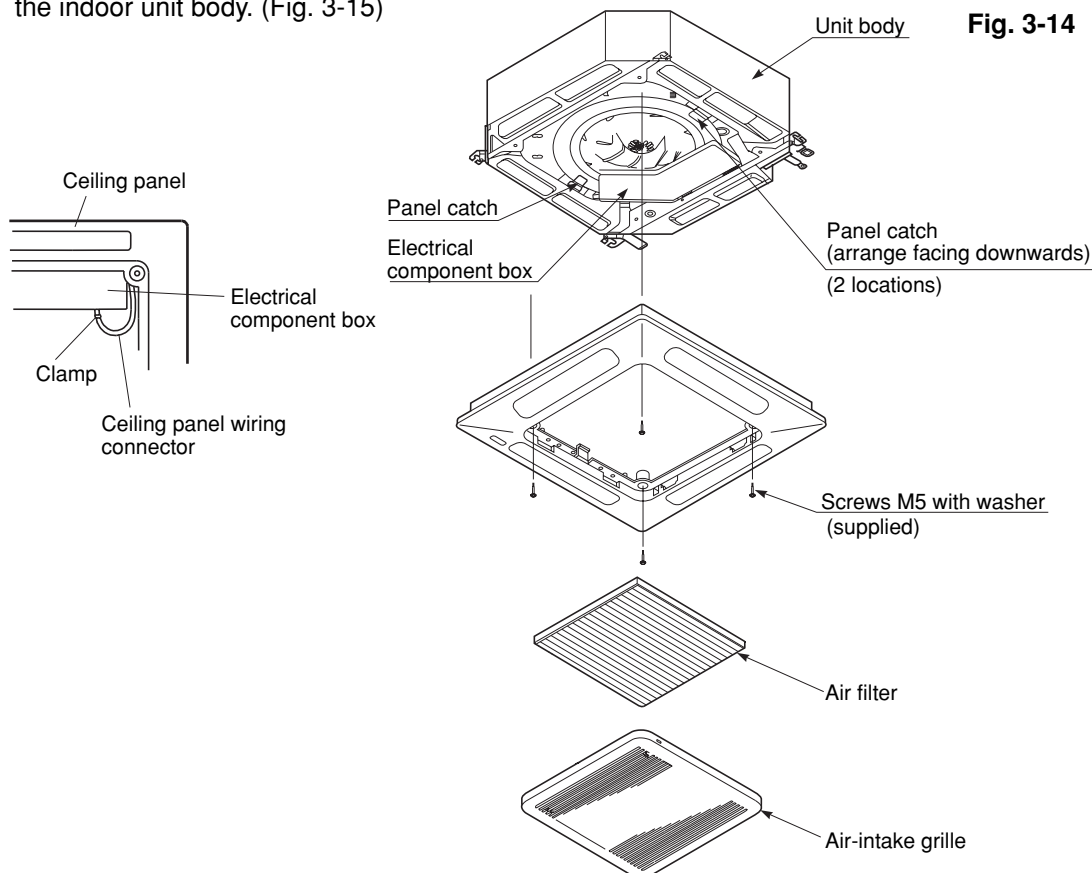
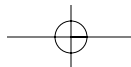
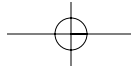

Fig. 3-15





3-7. Installing the Ceiling Panel

- (1) Lift the ceiling panel and position it to align the panel hook with the panel catch of the indoor unit.

NOTE

The ceiling panel must be mounted in the correct direction. Note that the 2 catches of the panel differ in size. Confirm that the catches are correctly matched between the ceiling panel and the indoor unit body.

- (2) Next, check to see that the ceiling panel is properly aligned with the seamline of the ceiling. If it is not, remove the ceiling panel and slightly readjust the indoor unit body to the proper suspension point.
- (3) When the ceiling panel has been properly aligned, use the supplied 4 mounting screws (M5) with washers to permanently fasten the ceiling panel.
- (4) Install the wiring connector from the ceiling panel to the connector in the electrical component box of the indoor unit. After installing the connector, use the clamp on the body of the indoor unit to secure the wiring.
- (5) Install the air filter and air-intake grille by performing the steps in section 3-6 in reverse.

NOTE

Rehook the safety cord before closing the air-intake grille.

3-8. When Removing the Ceiling Panel for Servicing

When removing the ceiling panel for servicing, remove the air-intake grille and air filter, disconnect the wiring connector inside the electrical component box, and then remove the 4 mounting screws.

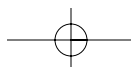
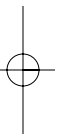
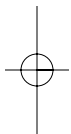

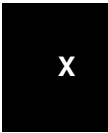
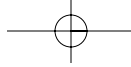

3-9. Duct for Fresh Air

- There is a duct connection part on side of the indoor unit. (Fig. 3-16)
- An optional air-intake plenum (including duct connection box and flange) can be attached to the indoor unit.

Air-intake plenum	Type
CMB-GSJ80U	PNR-XH2442 (XH(W)2672R)
CMB-GSJ140U	PNR-XH3642 (XH(W)3672R, XH(W)4272R)

(1) Accessories

- Check that the following parts are in the box when unpacking.

Name	Q'ty	Remarks
Cord with socket (9P)	1	Connecting line. Not necessary for intaking fresh air.
Screw (M5 × L5 in.)	4	Air-intake filter (for fastening)
Screw (M4 × L1/2 in.)	7	Duct connection flange / box (for fastening)
Duct connection box	1	(for fresh air)
Duct connection flange	1	(for connecting fresh air duct)

(2) Installation

- Installation steps (a) to (d) are the same for both the CMB-GSJ80U and the CMB-GSJ140U. The figure illustrates installation of air-intake plenum to the indoor unit. (Fig. 3-17)

(a) Installing the air-intake plenum

- Set the air-intake plenum to the indoor unit taking care not to set it in the wrong direction. (Fig. 3-17)
- Fasten the air-intake plenum with the accessory screws. (M5 × L5 in., 4 pcs) (Fig. 3-17)

(b) Installing the duct connection box

- Fasten the duct connection flange to the duct connection box with the accessory screws. (M4 × L1/2 in., 4 pcs) (Fig. 3-18)
- Put the duct connection box into the rectangular hole of the air-intake plenum and fasten it to both sides of the indoor unit and plenum with the accessory screws. (M4 × L1/2 in., 3 pcs) (Fig. 3-18)

(c) Installing the indoor unit

- Install the indoor unit to the ceiling. (Install the indoor unit according to items 3-1 to 3-6.)



CAUTION

When installing in a pre-existing location, install the indoor unit before installing the duct connection box.

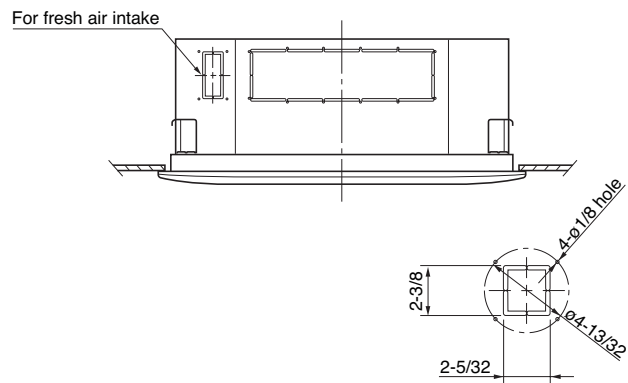

Detail of fresh air intake

Unit: inch

Fig. 3-16

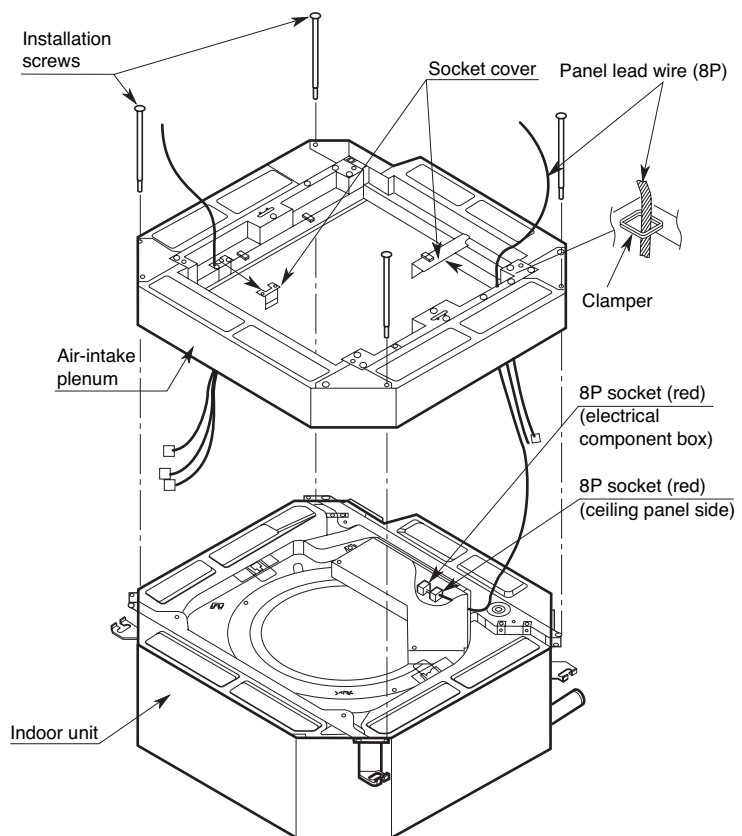
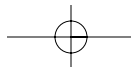
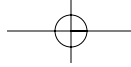

Fig. 3-17





(d) Installing the ceiling panel

- Attach the ceiling panel to the chamber. Drawing the panel downwards sets the panel in position temporarily with the panel catch (at 2 locations).
- Remove the socket cover of the air-intake plenum and pass the 8P sockets through it. (Fix the panel lead wire with the chamber side clamp.) (Fig. 3-17)
- Connect the 8P socket (electrical component box side) to the 8P socket (ceiling panel side) of the indoor unit electrical component box.
- Reattach the socket cover.

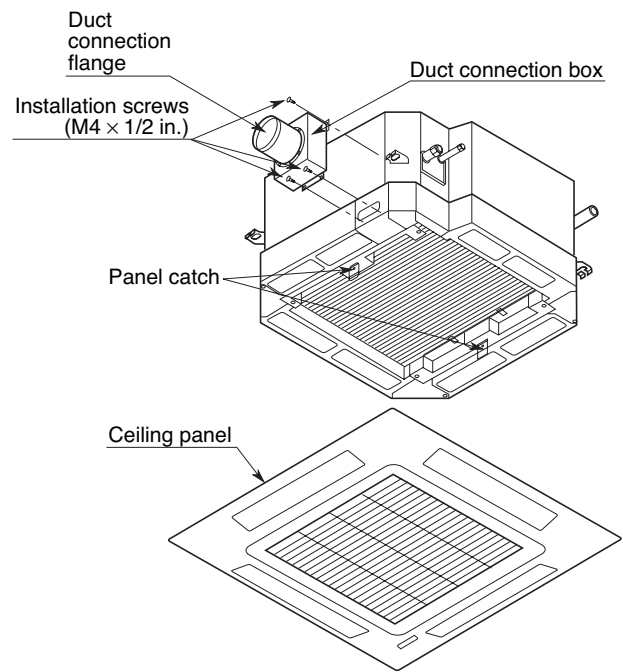
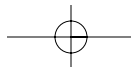
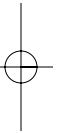
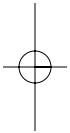
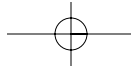

Fig. 3-18





■ Wall-Mounted Type (K Type)

3-10. Removing the Wall Fixture from the Unit

KH(S)2672R

Remove and discard the set screws and take off the rear panel. (Fig. 3-19)

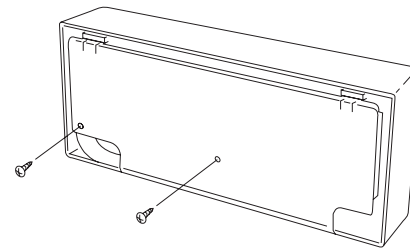

Set screws for transportation only

Fig. 3-19

K

NOTE

Tubing can be extended in 3 directions as shown in Fig. 3-20. Select the direction that provides the shortest run to the outside unit.

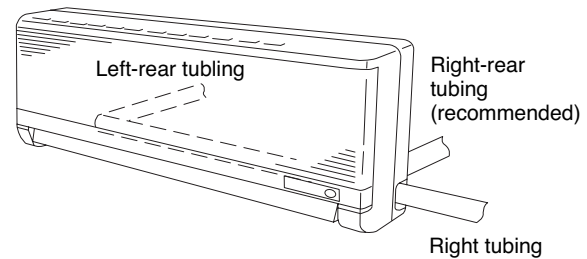

Fig. 3-20

3-11. Selecting and Making a Hole

KH(S)2672R

- (1) Remove the rear panel from the indoor unit and place it on the wall at the location selected. Make sure the unit is horizontal using a carpenter's level or tape measure to measure down from the ceiling.
- (2) Determine which side of the unit you should make the hole. (Fig. 3-21)
- (3) Before making a hole, check carefully that no studs or pipes are directly run behind the spot to be cut.

In case of left-rear or right-rear tubing

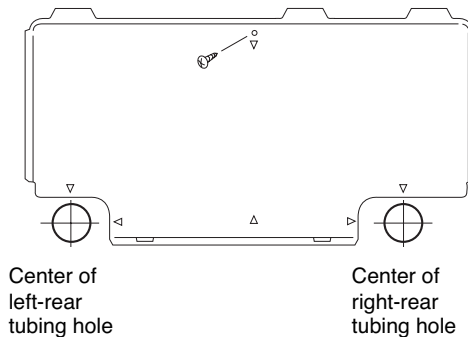

Fig. 3-21



CAUTION

Also avoid areas where electrical wiring or conduits are located.

The above precautions are also applicable if tubing goes through the wall in any other location.

NOTE

Hole should be made at a slight downward slant to the outdoor side.

- (4) Using a sabre saw, key hole saw or hole-cutting drill attachment, cut a hole in the wall. See Table 3-3 and Fig. 3-22.

Table 3-3

Hole Dia. (inch)
3-3/16"

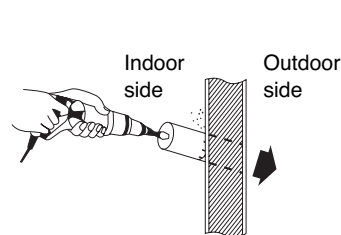
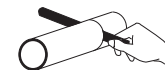

Fig. 3-22

PVC pipe (locally purchased)



Cut at slight angle

Fig. 3-23

- (5) Measure the thickness of the wall from the inside edge to the outside edge and cut PVC pipe at a slight angle 1/4" shorter than the thickness of the wall. (Fig. 3-23)
- (6) Place the plastic cover over the end of the pipe (for indoor side only) and insert in the wall. (Fig. 3-24)

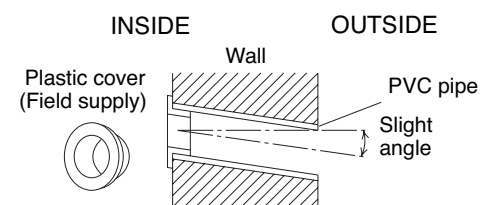
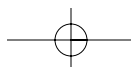

Fig. 3-24



KH(S)3072R, KH(S)3672R

One hole is required for the air conditioner tubing, and may be either on the left or right side. (Also see section 3-14. Preparing the Indoor Side Tubing.)

- (1) Tape the full-scale installation diagram on the wall at the location selected. Make sure the unit is horizontal using a level or tape measure to measure down from the ceiling. (Fig. 3-25)
- (2) Determine if the hole is to be drilled at the left or right hole location.
- (3) Before drilling a hole, check that there are no studs or pipes behind the determined location.

**CAUTION**

Avoid any area where electrical wiring or conduit is located. Also take this precaution if the tubing goes through a wall at any other location.

- (4) Using a sabre saw, key hole saw or 3-5/32 in. hole-cutting drill attachment, make a hole in the wall. The required minimum hole diameter for these models is 3-3/16 in. (Fig. 3-26)
- (5) Measure the thickness of the wall from the inside edge to the outside edge and cut PVC pipe at a slight angle 1/4 in. shorter than the thickness of the wall. (Fig. 3-27)
- (6) Place the plastic cover over the end of the pipe, (for indoor side only) and insert in the wall. (Fig. 3-28)

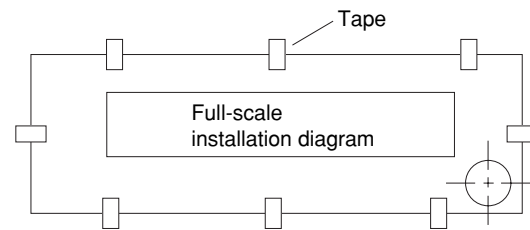
**Fig. 3-25****K****NOTE**

Hole should be made at a slight downward slant to the outdoor side.

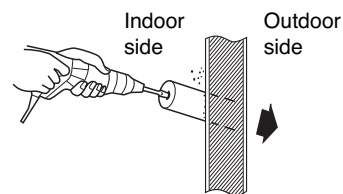
**Fig. 3-26**

PVC pipe (locally purchased)

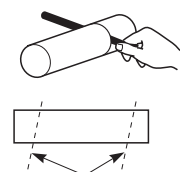

Cut at slight angle

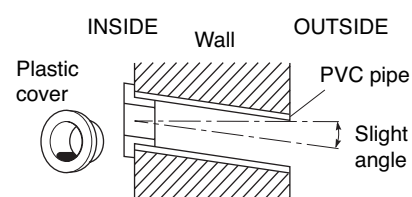
Fig. 3-27**Fig. 3-28**

KHH(S)2672R

Remove and discard the set screws and take off the wall fixture. (Fig. 3-29)

KHH(S)2672R

K

- (1) Tape the full-scale installation diagram on the wall at the location selected. Make sure the unit is horizontal using a level or tape measure to measure down from the ceiling. (Fig. 3-30)
- (2) Before drilling a hole, check that there are no studs or pipes behind the determined location.



CAUTION

Avoid any area where electrical wiring or conduit is located. Also take this precaution if the tubing goes through a wall at any other location.

- (3) Using a sabre saw, key hole saw or 3-5/32 in. hole-cutting drill attachment, make a hole in the wall. The required minimum hole diameter for these models is 3-3/16 in. (Fig. 3-31)
- (4) Measure the thickness of the wall from the inside edge to the outside edge and cut PVC pipe at a slight angle 1/4 in. shorter than the thickness of the wall. (Fig. 3-32)
- (5) Place the plastic cover over the end of the pipe, (for indoor side only) and insert in the wall. (Fig. 3-33)

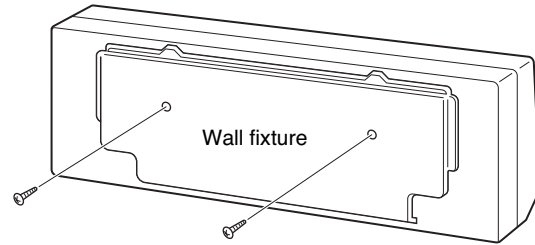

Set screws only for transportation

Fig. 3-29

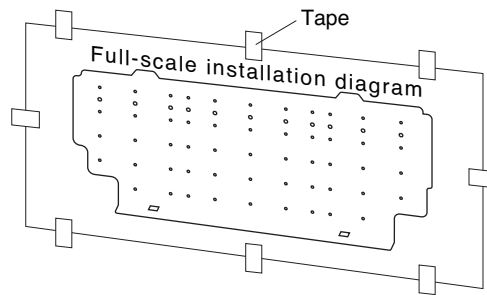

Fig. 3-30

NOTE

Hole should be made at a slight downward slant to the outdoor side.

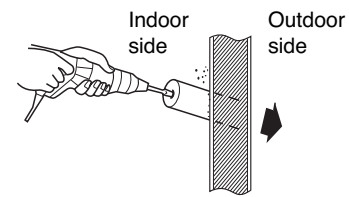
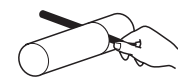

Fig. 3-31

PVC pipe (locally purchased)



Cut at slight angle

Fig. 3-32

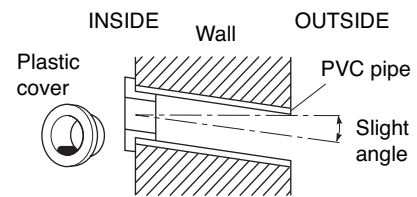
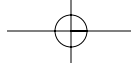

Fig. 3-33



3-12. Installing the Rear Panel on the Wall

KH(S)2672R

Be sure to confirm that the wall is strong enough to suspend the unit.

See either Item a) or b) below depending on the wall type.

a) If Wooden Wall

- (1) Attach the rear panel to the wall with the 10 screws provided. (Fig. 3-34)

If you are not able to line up the holes in the rear panel with the beam locations marked on the wall, use toggle bolts to go through the holes on the panel or drill 3/16 in. dia. holes in the panel over the stud locations and then mount the rear panel.

- (2) Double-check with a ruler or carpenter's level that the panel is level. This is important to install the unit properly. (Fig. 3-35)
- (3) Make sure the panel is flush against the wall. Any space between the wall and unit will cause noise and vibration.

b) If Block, Brick, Concrete or Similar Type Wall

Make 3/16" dia. holes in the wall. Insert rawl plugs for appropriate mounting screws. (Fig. 3-36)

KH(S)3072R, KH(S)3672R

Confirm that the wall is strong enough to support the unit.

a) If Wooden Wall

- (1) Attach the wall fixture to the wall with the 12 screws provided. (Fig. 3-37) If you are not able to line up the holes in the wall fixture with the beam locations marked on the wall, use rawl plugs or toggle bolts to go through the holes on the panel or drill 3/16 in. dia. holes in the wall fixture over the stud locations.
- (2) Check with a tape measure or carpenter's level that the wall fixture is level. This is important so that the unit is correctly installed.
- (3) Make sure the wall fixture is flush against the wall. Any space between the wall and unit will cause noise and vibration.

b) If Block, Brick, Concrete or Similar Type Wall

Make 3/16 in. dia. holes in the wall. Insert rawl plugs for appropriate mounting screws. (Fig. 3-36)

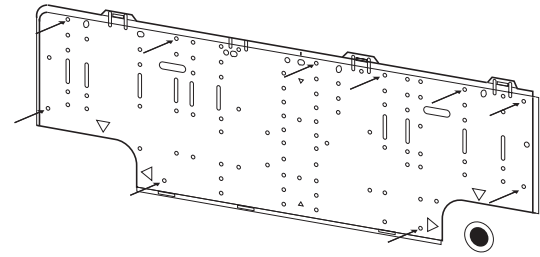

Fig. 3-34



Fig. 3-35

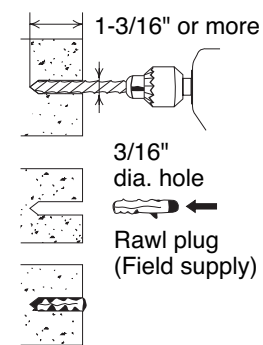

Fig. 3-36

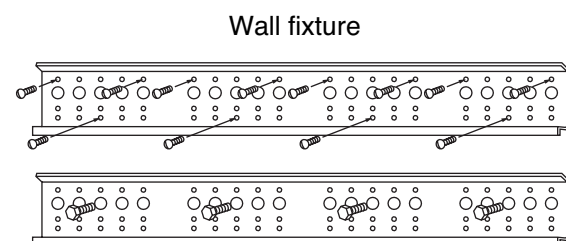
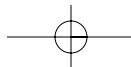

Fig. 3-37

K



KHH(S)2672R

Confirm that the wall is strong enough to support the unit.

a) If Wooden Wall

- (1) Attach the wall fixture to the wall with the 9 screws provided. (Fig. 3-38)
If you are not able to line up the holes in the wall fixture with the beam locations marked on the wall, use rawl plugs or toggle bolts to go through the holes on the panel or drill 13/64 in. dia. holes in the panel over the stud locations and then mount the wall fixture.
- (2) Check with a tape measure or carpenter's level that the wall fixture is level. This is important so that the unit is correctly installed.
- (3) Make sure the wall fixture is flush against the wall. Any space between the wall and unit will cause noise and vibration.

b) If the Wall is Brick, Concrete or Similar

Drill 3/16 in. dia. holes in the wall. Insert rawl plugs for appropriate mounting screws. (Fig. 3-39)

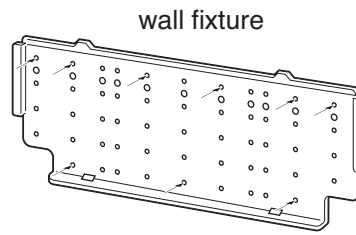

Fig. 3-38

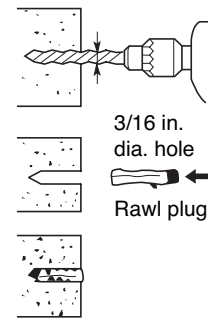
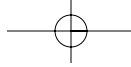

Fig. 3-39

K



3-13. Remove the Grille to Install the Indoor Unit

KH(S)2672R

Basically, these models can be installed and wired without removing the grille. **If access to any internal part is needed, follow the steps given below:**

How to remove the grille

- (1) Set the 2 flaps in the horizontal position.
- (2) Unscrew the 3 screws. (Fig. 3-40a)
- (3) Remove the grille.
 - (a) Hold both corners of the air intake grille, then pull out and up to open. (Fig. 3-40b)
 - (b) Use a standard screwdriver to push up the 3 tabs to remove the grille. (Fig. 3-40b)
 - (c) Pull the lower part of the grille toward you to remove. (Fig. 3-40a)

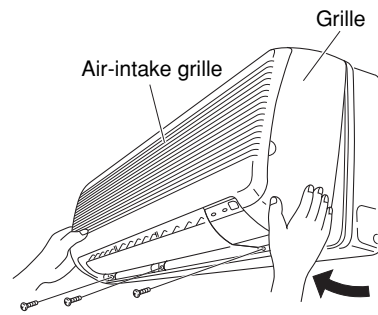

Fig. 3-40a

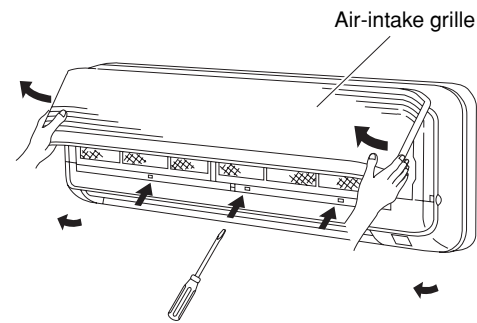

Fig. 3-40b

How to replace the grille

- (1) Close the flaps.
- (2) Reinstall the grille into the lower part while aligning its tabs on the upper part. (Fig. 3-41a) Insert the tabs in the slots and push the lower part of the grille back into position.
- (3) Press at each of the 5 tabs to completely close the grille. Make sure that the grille and frame are firmly fitted together. (Fig. 3-41b)

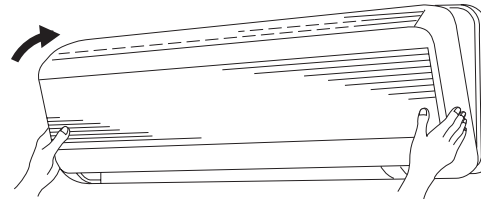

Fig. 3-41a

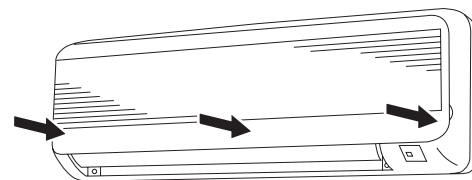
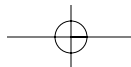
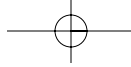

Fig. 3-41b

K





KH(S)3072R, KH(S)3672R

How to Remove the Grille

- (1) Remove the plastic cover. (Fig. 3-42)
- (2) Remove the clamp for the wiring connector. (Fig. 3-43)
- (3) Disconnect the 2 wiring connectors. (Fig. 3-44)
- (4) Set the flap in the horizontal position. (Fig. 3-45)
- (5) Remove the 3 screws. (Fig. 3-45)
- (6) Remove the grille. (Fig. 3-45)

K

NOTE

When replacing the grille, be careful not to crush the lead wires between the grille and the frame. (Fig. 3-45)

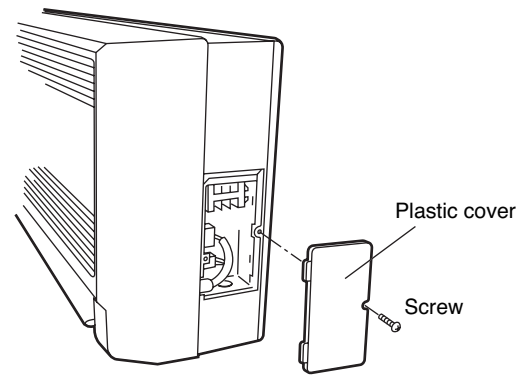

Fig. 3-42

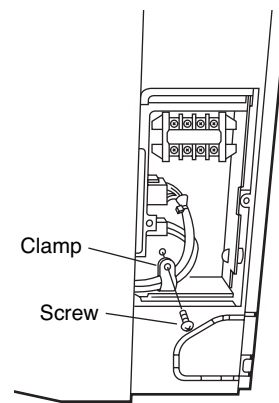

Fig. 3-43

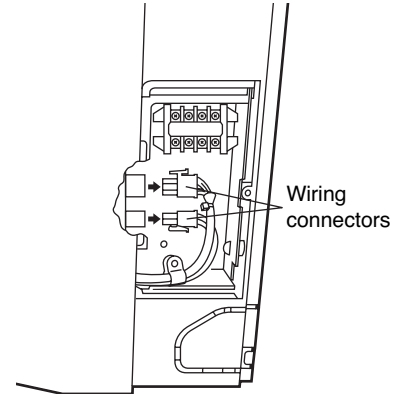

Fig. 3-44

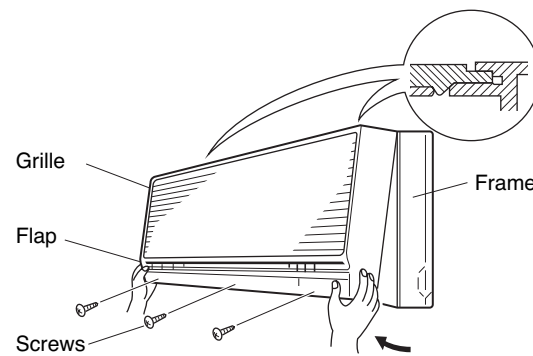
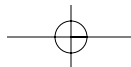

Fig. 3-45



3-14. Preparing the Indoor Side Tubing

KH(S)2672R

Arrangement of tubing by directions

- Right tubing
The corner of the right frame needs to be cut by a hacksaw or the like. (Fig. 3-46)
- Right-rear or left-rear tubing
In this case, the corner of the frame need not be cut.

To mount the indoor unit on the rear panel:

- Hang the 3 mounting slots of the unit on the upper tabs of the rear panel. (Fig. 3-47)

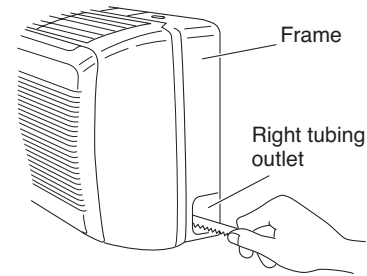

Fig. 3-46

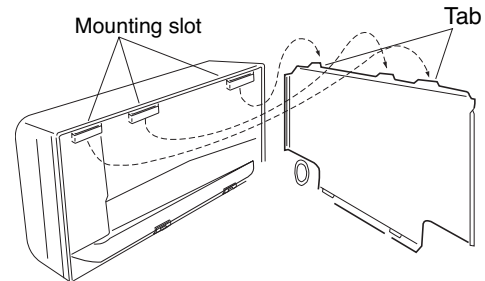

Fig. 3-47

KH(S)3072R, KH(S)3672R

Tubing can be extended in 4 directions as shown in Fig. 3-54.

Arrangement for Right-rear Tubing

- Remove the 2 screws and slide out the side cover. (Fig. 3-48)
- Extend the gas tube from the outdoor side and connect it directly to the mating tube inside the indoor unit. Use a flare nut. (Fig. 3-49)

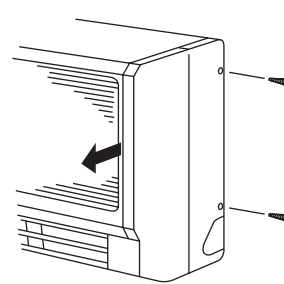

Fig. 3-48

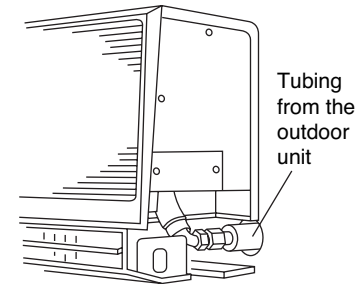

Fig. 3-49

Arrangement for Right Tubing

- Remove the 2 screws and take off the side cover. (Fig. 3-48)
- Cut out the L-shaped tubing outlet using a hacksaw. (Fig. 3-50)
- Using the L-shaped tube (field supply), connect tubing between the indoor and outdoor units. (Fig. 3-52)

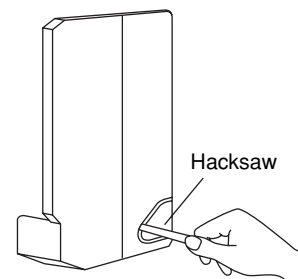

Fig. 3-50

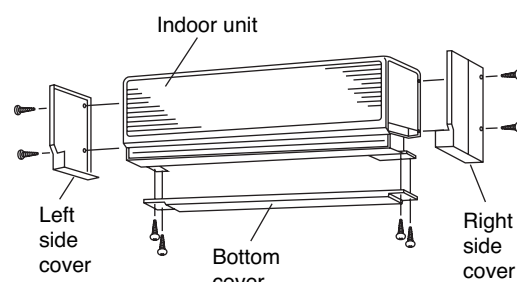
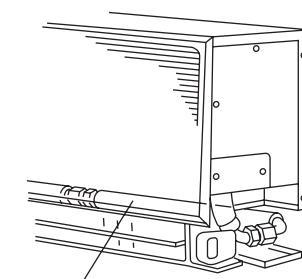

Fig. 3-51

Arrangement for Left and Left-rear Tubing.

- Remove the 4 screws (2 on each side) and take off both left and right side cover. (Fig. 3-51)
- Remove 4 screws to remove the bottom cover.
- Using the L-shaped tube (field supply), connect tubing as in Fig. 3-53.



L-shaped tube

Fig. 3-52

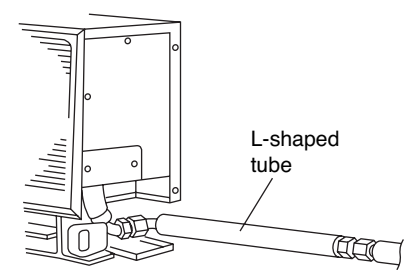

L-shaped tube

Fig. 3-53

KHH(S)2672R

Tubing can be extended in 4 directions as shown in Fig. 3-54.

Arrangement for Left Tubing

- (a) Cut out the left tubing outlet. (Fig. 3-55)

Arrangement for Right Tubing

- (a) Cut out the right tubing outlet using a hacksaw. (Fig. 3-56)

Arrangement for Left-rear and Right-rear Tubing

- (a) It is not necessary to cut a hole.

3-15. Wiring Instructions**General Precautions on Wiring**

- (1) Before wiring, confirm the rated voltage of the unit as shown on its nameplate, then carry out the wiring closely following the wiring diagram.
- (2) Provide a power outlet to be used exclusively for each unit. A power supply disconnect and circuit breaker for overcurrent protection should be provided in the exclusive line.
- (3) To prevent possible hazards from insulation failure, the unit must be grounded.
- (4) All wiring must be connected tightly.
- (5) Do not allow wiring to touch refrigerant tubing, compressor, or any moving parts of the fan.

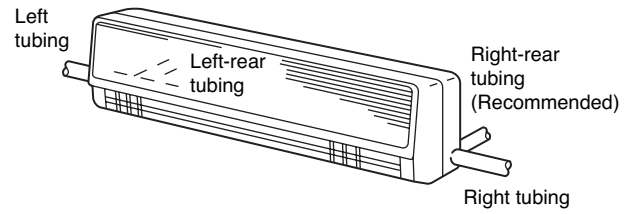
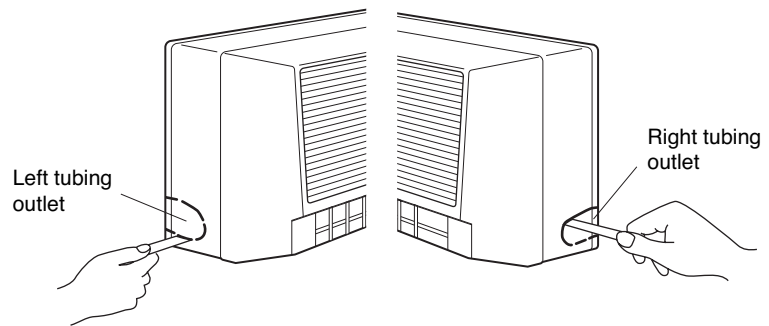

Unauthorized changes in the internal wiring can be very dangerous. The manufacturer will accept no responsibility for any damage or misoperation that occurs as a result of such unauthorized changes.

**Fig. 3-54****Fig. 3-55****Fig. 3-56**

3-16. Wiring Instructions for Inter-Unit Connections

KH(S)2672R

- (1) Insert the inter-unit wiring (according to local electrical codes) into the through-the-wall PVC pipe. Run the wiring toward the indoor side allowing approx. 10 inches to extend from the wall face. (Fig. 3-57)
- (2) Route the inter-unit wiring from the back of the indoor unit and pull it toward the front for connection. (Figs. 3-58a and 3-58b)
- (3) Connect the inter-unit wiring to the corresponding terminals on the terminal plate (Figs. 3-58a and 3-58b) while referring to the wiring diagram.
- (4) Be sure to secure the wiring with the provided clamp.

How to remove the cover plate

To access the terminal plate inside the indoor unit, follow these steps.

- (1) Using a Phillips screwdriver, remove the screw on the cover plate. (Figs. 3-58a and 3-58b)
- (2) Remove the cover plate.

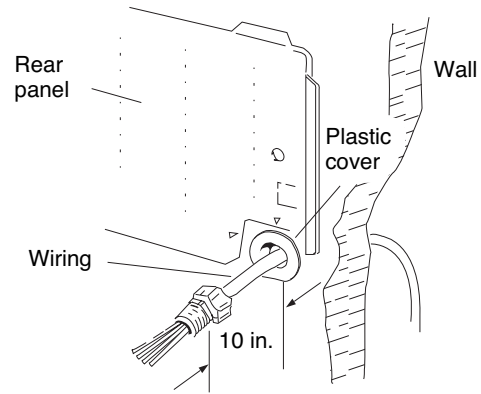

Fig. 3-57

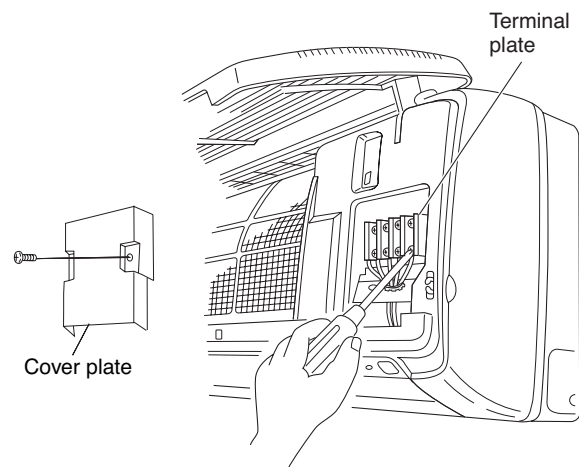

Fig. 3-58a

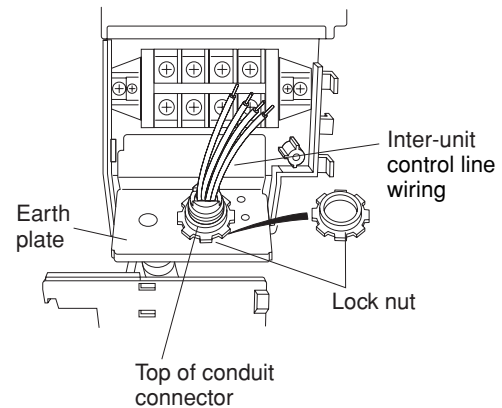
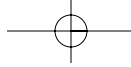

Fig. 3-58b





- (1) Insert the inter-unit wiring (according to local codes) into the through-the-wall PVC pipe. Run the wiring toward the indoor side allowing approx. 5" to extend from the wall face.
(Figs. 3-59a and 3-59b)

K



CAUTION

Never fix the wiring by any means before the indoor unit is fully seated on the rear panel.

- (2) Remove the side cover and the metallic cover.
(Fig. 3-60 or 3-61, depending on model.)
- (3) Secure the conduit connector to the chassis with a lock nut. (Fig. 3-60 or 3-61)
- (4) Give some play to the inter-unit wiring from the outdoor unit to the corresponding terminals on the terminal plate.



CAUTION

- Be sure to refer to the wiring system diagram label inside the metallic cover and carry out the correct field wiring. Wrong wiring can cause the unit to malfunction.
- Check local electrical codes and any specified wiring instructions or limitations.

- (5) Secure the metallic cover with its screw. Then replace the side cover.

KHH(S)2672R

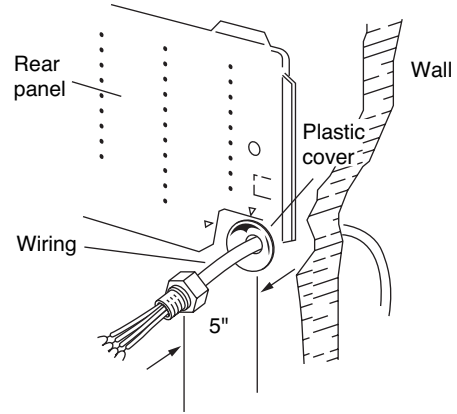

Fig. 3-59a

KH(S)3072R, KH(S)3672R

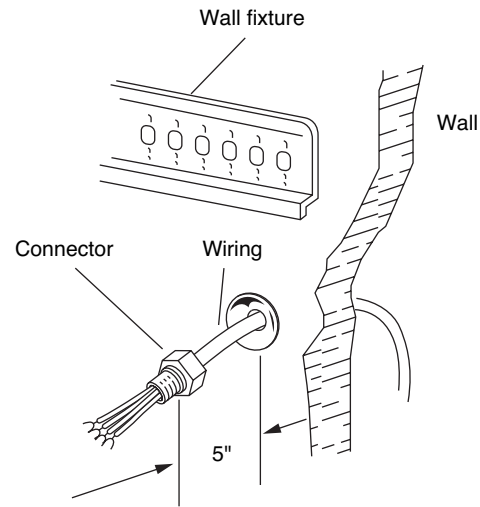

Fig. 3-59b

KHH(S)2672R

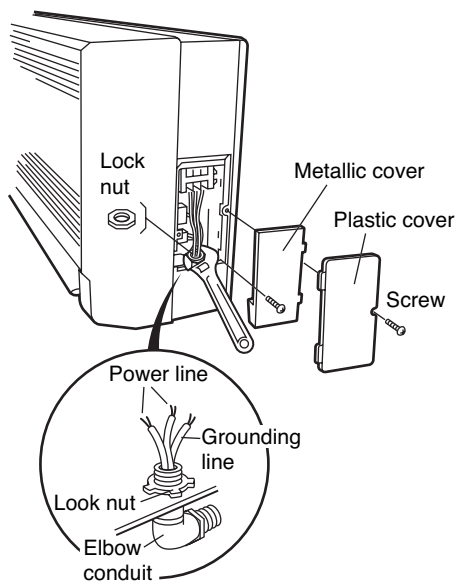

Fig. 3-60

KH(S)3072R, KH(S)3672R

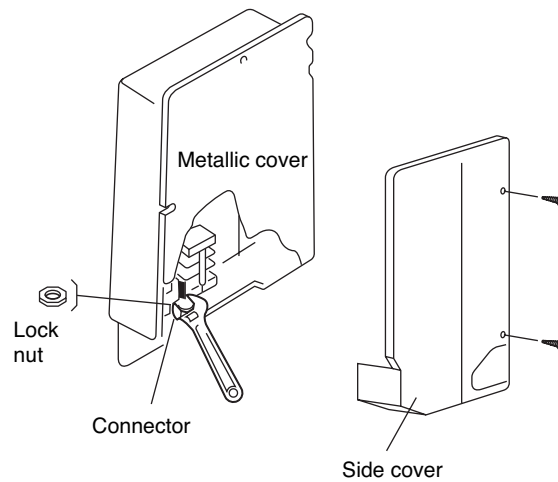
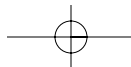

Fig. 3-61



KHH(S)2672R

- (1) Shape the refrigerant tubing so that it can easily go into the wall hole. (Fig. 3-62)

**CAUTION**

If using a stepladder, be careful to keep your balance and not fall off. To prevent the unit from damage and avoid personal injury, ask for someone's help when feeding the tubing through the hole because the unit is heavy and difficult to hold in place.

- (2) Push the wiring, refrigerant tubing, and drain hose through the hole in the wall. Adjust the indoor unit so it is securely seated on the rear panel.
- (3) Carefully bend the tubing (if necessary) to run along the wall in the direction of the outdoor unit and then tape as far as the fittings.

**CAUTION**

The air conditioner's performance will deteriorate if a tube is crushed. To prevent crushing of tubing, avoid sharp bends. Use a pipe bending tool to bend tubes. (Fig. 3-63)

- (4) Connect the refrigerant tubing to the outdoor unit. (After performing a leak test on the connecting part, insulate it with tubing insulation. (Fig. 3-64)) Also, refer to Section 10-5. Connecting Tubing between Indoor and Outdoor Units.

- (5) Assemble the refrigerant tubing, drain hose, and inter-unit wiring as shown in Fig. 3-65.

KH(S)3072R, KH(S)3672R

- (1) Shape the narrow refrigerant tube and drain hose in the desired direction so that they can easily go into the wall hole. (Fig. 3-66)
- (2) Push the wiring, narrow tube, and drain hose through the hole in the wall.
- (3) Bend the tubing (if necessary) to run along the wall in the direction of the outdoor unit, then tape as far as the fittings. The drain hose should come straight down the wall to a point where water runoff won't stain the wall.
- (4) Hang the indoor unit on the wall fixture. (Fig. 3-67)
- (5) Install the mounting plate to secure the indoor unit solidly to the wall. The plate can be positioned in either of the 2 ways shown. (Fig. 3-68)

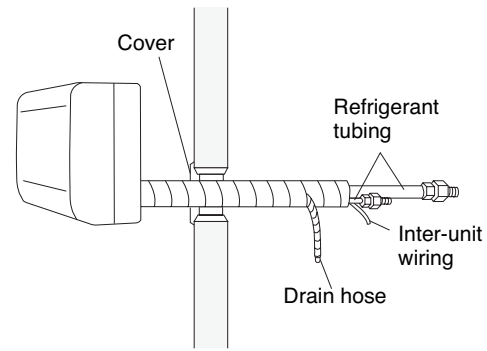
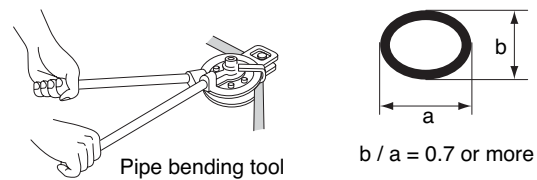
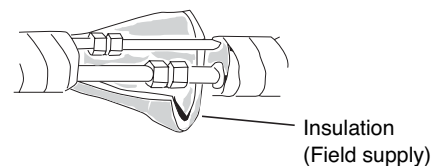
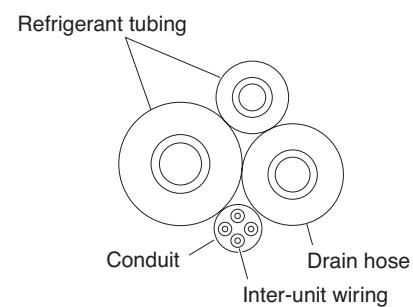
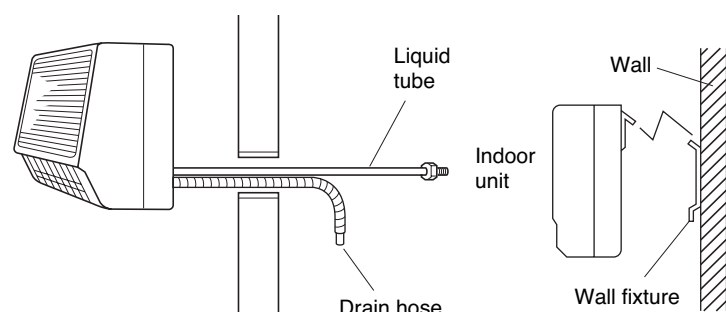
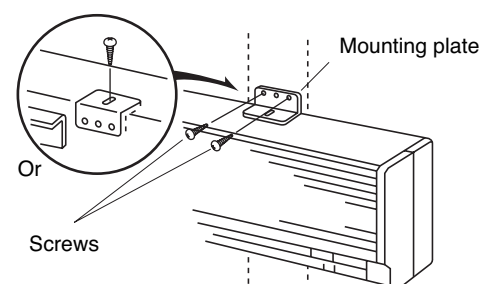
**Fig. 3-62****Fig. 3-63****Fig. 3-64****Fig. 3-65****Fig. 3-66****Fig. 3-67****Fig. 3-68**

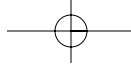

3-17. Shaping the Tubing

KHH(S)2672R

K

- (1) Shape the refrigerant tubing so that it can easily go into the hole. (Fig. 3-69)
- (2) Push the wiring, refrigerant tubing and drain hose through the hole in the wall. Adjust the indoor unit so it is securely seated on the wall fixture.
- (3) Carefully bend the tubing (if necessary) to run along the wall in the direction of the outdoor unit and then insulate to the end of the fittings. The drain hose should come straight down the wall to a point where water runoff will not stain the wall.
- (4) Connect the refrigerant tubing to the outdoor unit. (After performing a leak test on the connection, insulate it with insulating tape. (Fig. 3-70)) Also, refer to Section 10-5. Connecting Tubing between Indoor and Outdoor Units.
- (5) Assemble the refrigerant tubing, drain hose and inter-unit wiring as shown in Fig. 3-71.

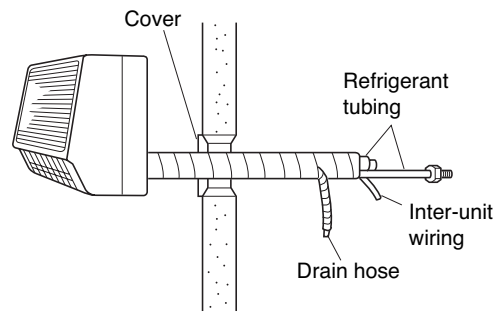

Fig. 3-69

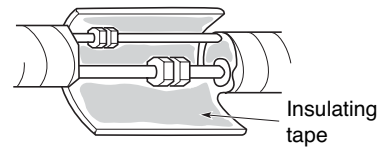

Fig. 3-70

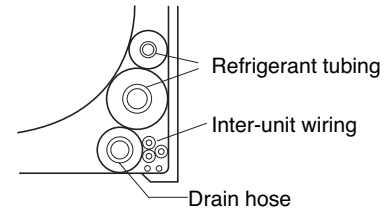

Fig. 3-71

3-18. Installing the Drain Hose

- (1) The drain hose should be slanted downward on the outdoor side. (Fig. 3-72)
- (2) Never form a trap in the course of the hose.
- (3) If the drain hose will run in the room, insulate* the hose so that chilled condensation will not damage furniture or floors. (Fig. 3-73)

* Foamed polyethylene or its equivalent is recommended.



WARNING

Do not supply power to the unit or operate it until all tubing and wiring to the outdoor unit are completed.

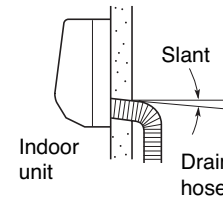

Fig. 3-72

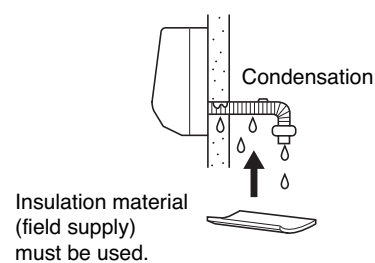
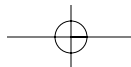

Fig. 3-73



■ Ceiling-Mounted Type (T Type)

3-19. Suspending the Indoor Unit

- (1) Place the full-scale diagram (supplied) on the ceiling at the spot where you want to install the indoor unit. Use a pencil to mark the drill holes. (Fig. 3-74).

NOTE

Since the diagram is made of paper, it may shrink or stretch slightly because of high temperature or humidity. For this reason, before drilling the holes maintain the correct dimensions between the markings.

- (2) Drill holes at the 4 points indicated on the full-scale diagram.
- (3) Depending on the ceiling type:
 - (a) Insert suspension bolts as shown in Fig. 3-75.
 - or
 - (b) Use existing ceiling supports or construct a suitable support as shown in Fig. 3-76.



WARNING

It is important that you use extreme care in supporting the indoor unit from the ceiling. Ensure that the ceiling is sufficiently strong enough to support the weight of the unit. Before hanging the ceiling unit, test the strength of each attached suspension bolt.

- (4) Screw in the suspension bolts, allowing them to protrude from the ceiling as shown in Fig. 3-76. The distance of each exposed bolt must be of equal length within 2 inches. (Fig. 3-77)

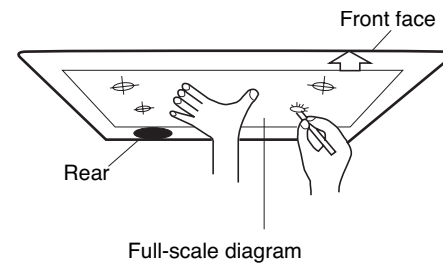

Fig. 3-74

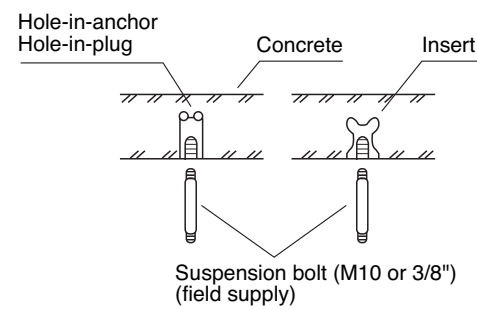

Fig. 3-75

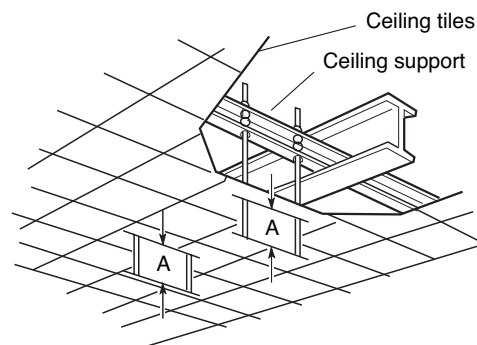

Fig. 3-76

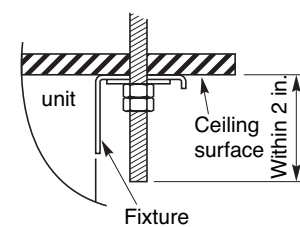

Fig. 3-77

T

- (5) Before suspending the indoor unit, remove the 2 screws on the latch of the air-intake grilles, open the grilles, and remove them by pushing the claws of the hinges as shown in Fig. 3-78. Then remove both side panels sliding them along the unit toward the front after removing the two screws which fix them. (Fig. 3-79)
- (6) Preparation for suspending the indoor unit. The suspension method varies depending on whether the unit is next to the ceiling or not. (Figs. 3-80 and 3-81)

T

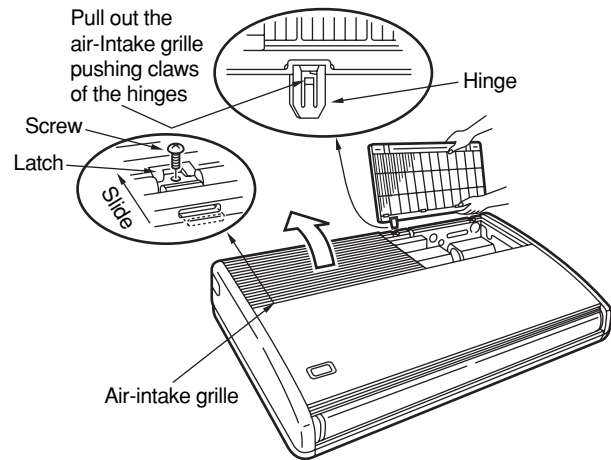

Fig. 3-78

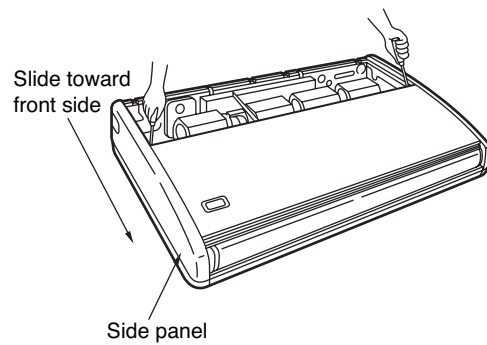

Fig. 3-79

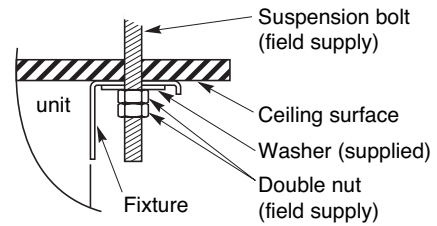

Fig. 3-80

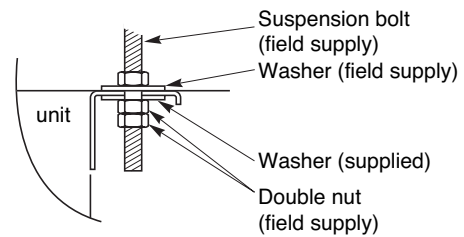

Fig. 3-81

(7) Suspend the indoor unit as follows.

- (a) Mount a washer and two hexagonal nuts on each suspension bolt as shown in Fig. 3-82.
- (b) Lift the indoor unit, and place it on the washers through the notches, to fix it in place. (Fig. 3-83)
- (c) Tighten the two hexagonal nuts on each suspension bolt to suspend the indoor unit as shown in Fig. 3-84.

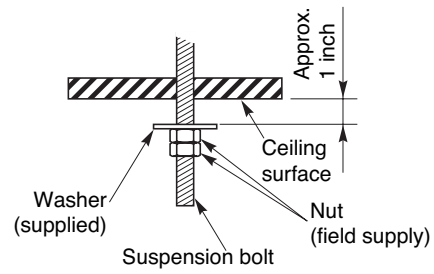

Fig. 3-82

NOTE

A ceiling surface is not always level. Please confirm that the indoor unit is evenly suspended. For the installation to be correct, leave a clearance of about 3/8 in. between the ceiling panel and the ceiling surface and fill the gap with an appropriate insulation or filler material.

- (8) If the tubing and wiring are to go towards the rear of the unit, make holes in the wall. (Fig. 3-85)
- (9) Measure the thickness of the wall from the inside to the outside and cut PVC pipe at a slight angle to fit. Insert the PVC pipe in the wall. (Fig. 3-86)

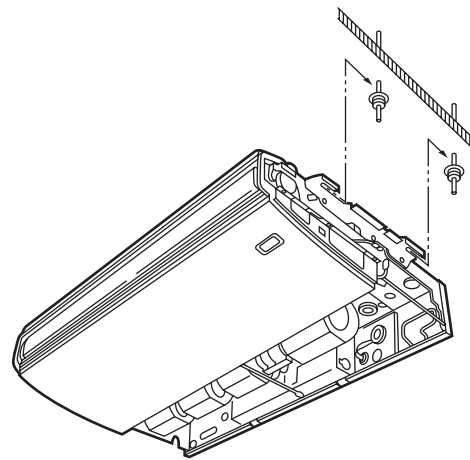

Fig. 3-83

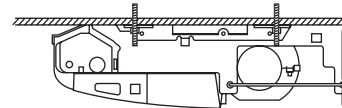

Fig. 3-84

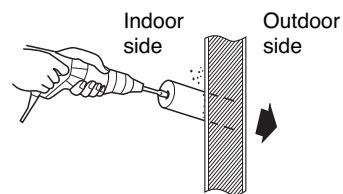

Fig. 3-85

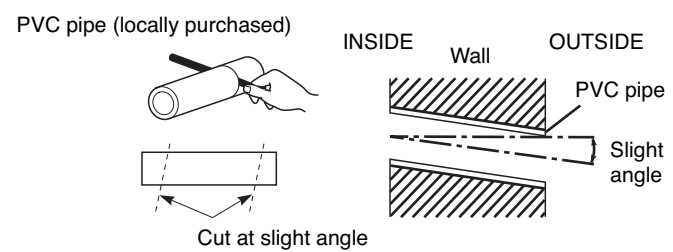

Fig. 3-86

3-20. Duct for Fresh Air

There is a duct connection port (knock-out hole) at the right-rear on the panel top of the indoor unit for drawing in fresh air. If it is necessary to draw in fresh air, remove the cover by knocking it out and connect the duct to the indoor unit through the connection port. (Fig. 3-87)
 If connection at the right-rear on the panel top is not appropriate, another duct connection port can be made by cutting an opening on the left side of the rear panel of the indoor unit as shown in Fig. 3-88.

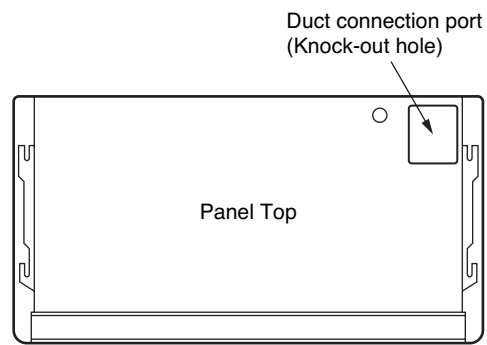
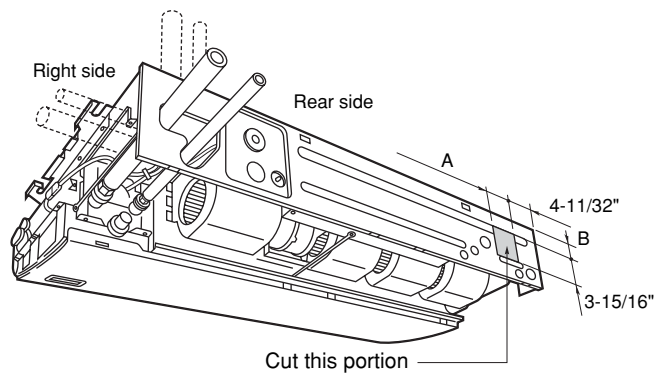

Fig. 3-87

3-21. Installing the Drain Piping

- Prepare a standard PVC pipe for the drain and connect it to the indoor unit drain pipe with the supplied hose clamps to prevent water leaks.
- Connect the drain piping so that it slopes downward from the unit to the outside. (Fig. 3-89)
- Never allow traps to occur in the course of the piping.
- Insulate any piping inside the room to prevent dripping.
- Use the supplied drain pipe to connect the drain pipe with the drain outlet of the indoor unit.
- After connecting the drain pipe securely, wrap the supplied drain pipe insulator around the pipe, seal the gap at the drain socket with the supplied black insulation tape, then secure it with clamps. (Fig. 3-90)
- After the drain piping, pour water into the drain pan to check that the water drains smoothly.



	TH(W)2672R, THH(W)2672R	TH(W)3672R, TH(W)4272R, THH(W)3672R
A	3-15/16"	7-3/32"
B	1-3/8"	1-31/32"

Fig. 3-88



CAUTION

Check local electrical codes and regulations before obtaining wire. Also, check any specified instruction or limitations.

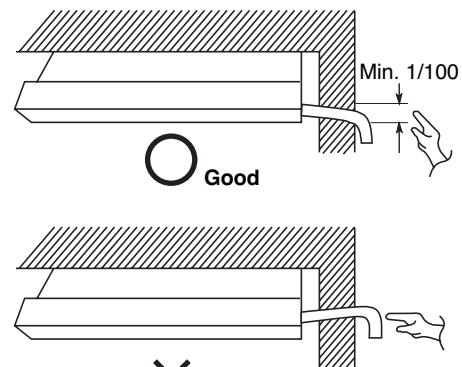

Fig. 3-89

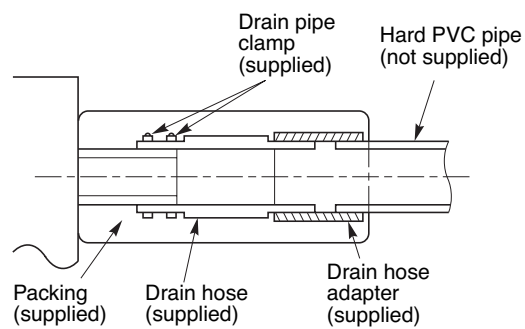
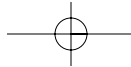

Fig. 3-90



■ Concealed-Duct Type (U Type)

3-22. Required Minimum Space for Installation and Service

- This air conditioner is usually installed above the ceiling so that the indoor unit and ducts are not visible. Only the air intake and air outlet ports are visible from below.
- The minimum space for installation and service is shown in Fig. 3-91 and Table 3-4.
- It is recommended that space is provided (17-23/32 × 17-23/32 in.) for checking and servicing the electrical system.
- Fig. 3-92 and Table 3-5 show the detailed dimensions of the indoor unit.

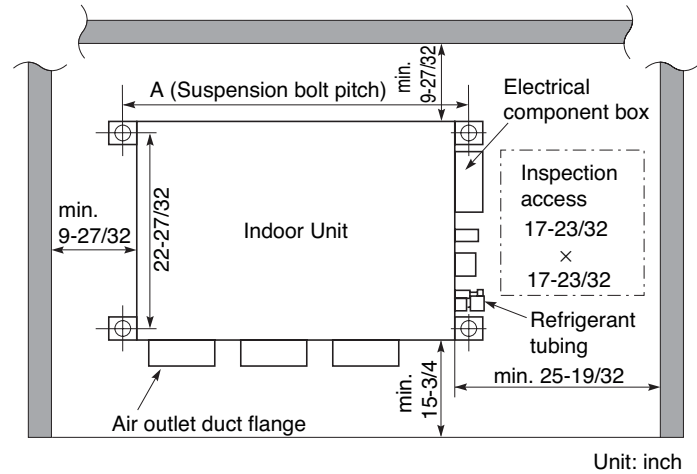

Fig. 3-91

Unit: inch

Table 3-4

Unit: inch (mm)

Type	26	36
A (Length)	42-17/32 (1,080)	61-13/32 (1,560)
Number of duct flanges	3	4

Table 3-5

Unit: inch (mm)

Dimension Type	A	B	C	D	E	F	G	H	I	J	K	No. of holes	
												L	M
UH(W)2672R	37-7/8	35-7/16 (7-3/32×5)	39-3/8	42-17/32	11-13/32	2-23/32	38-19/32	39-31/32	5-1/8	9-21/32 (9-21/32×1)	9-27/32	12	16
UH(W)3672R	56-25/32	54-11/32 (9-1/16×6)	58-9/32	61-13/32	13-3/16	12-7/32	57-15/32	58-27/32	5-1/8	19-9/32 (9-21/32×2)	9-7/16	16	18

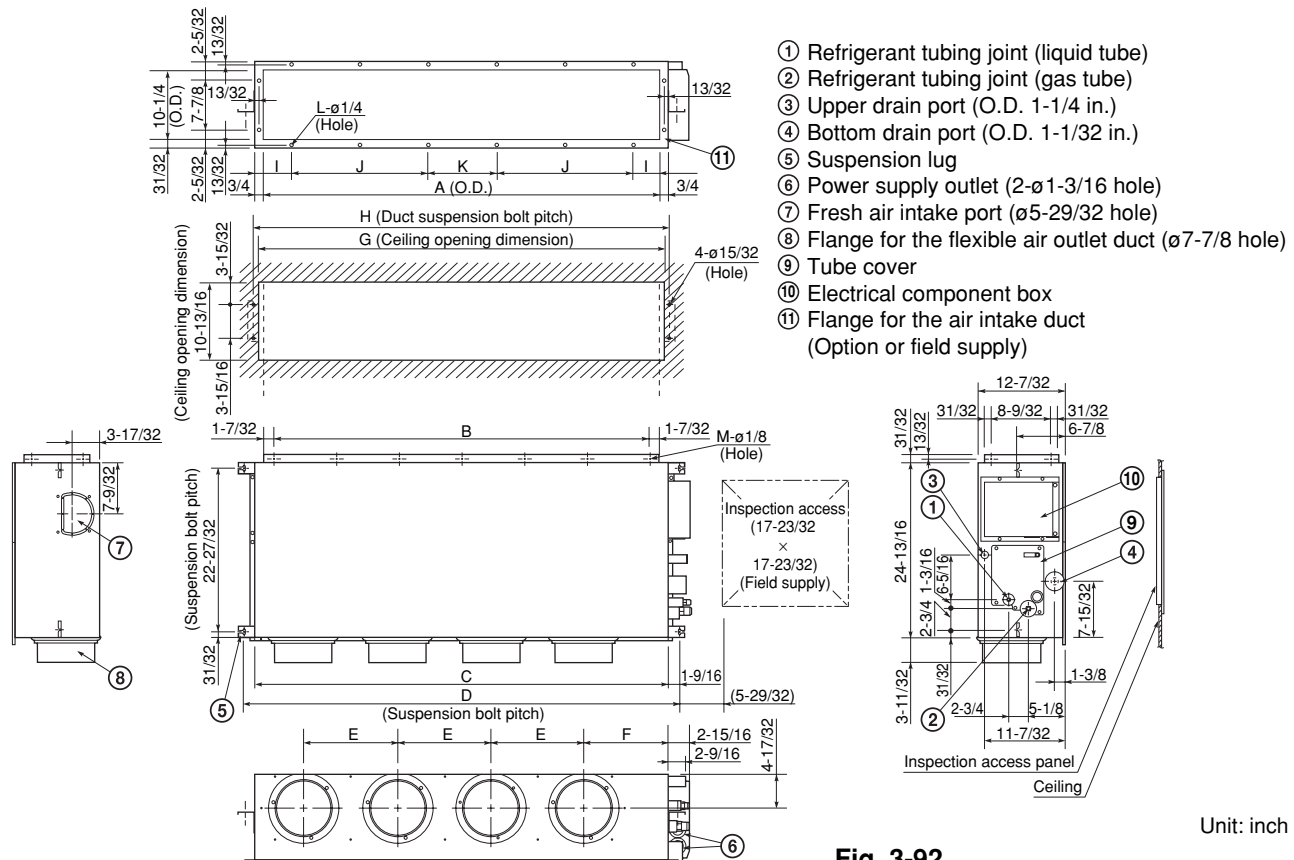
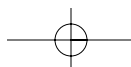
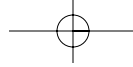

Fig. 3-92

Unit: inch





3-23. Suspending the Indoor Unit

Depending on the ceiling type:

- Insert suspension bolts as shown in Fig. 3-93 or
- Use existing ceiling supports or construct a suitable support as shown in Fig. 3-94.



WARNING

It is important that you use extreme care in supporting the indoor unit inside the ceiling. Ensure that the ceiling is strong enough to support the weight of the unit. Before hanging the unit, test the strength of each attached suspension bolt.

U

- (1) When placing the unit inside the ceiling, determine the pitch of the suspension bolts referring to the dimensional data on the previous page. (Fig. 3-92)
Tubing must be laid and connected inside the ceiling when suspending the unit. If the ceiling is already constructed, lay the tubing into position for connection to the unit before placing the unit inside the ceiling.
- (2) Screw in the suspension bolts allowing them to protrude from the ceiling as shown in Fig. 3-93. (Cut the ceiling material, if necessary.)
- (3) Thread the 2 hexagonal nuts and washers (field supply) onto the 4 suspension bolts as shown in Figs. 3-95 and 3-96. Use 2 sets of nuts and washers (upper and lower), so that the unit will not fall off the suspension lugs.

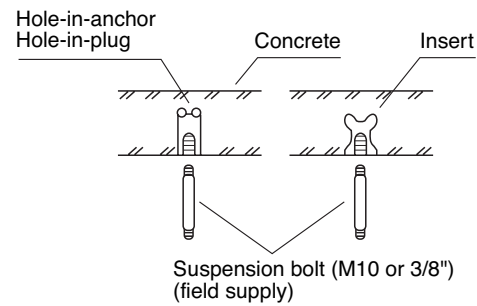

Fig. 3-93

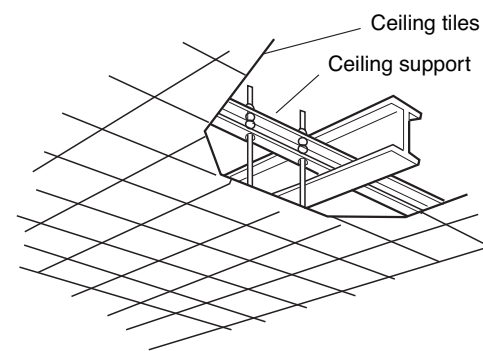

Fig. 3-94

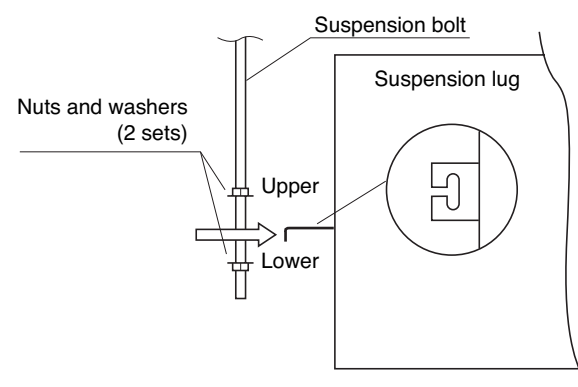

Fig. 3-95

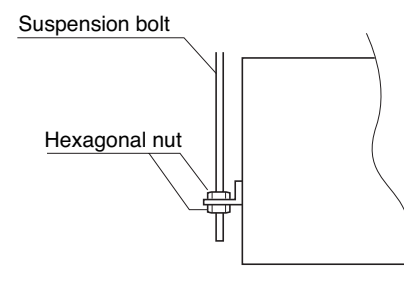
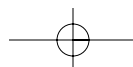
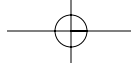

Fig. 3-96





- Fig. 3-97 shows an example of installation.

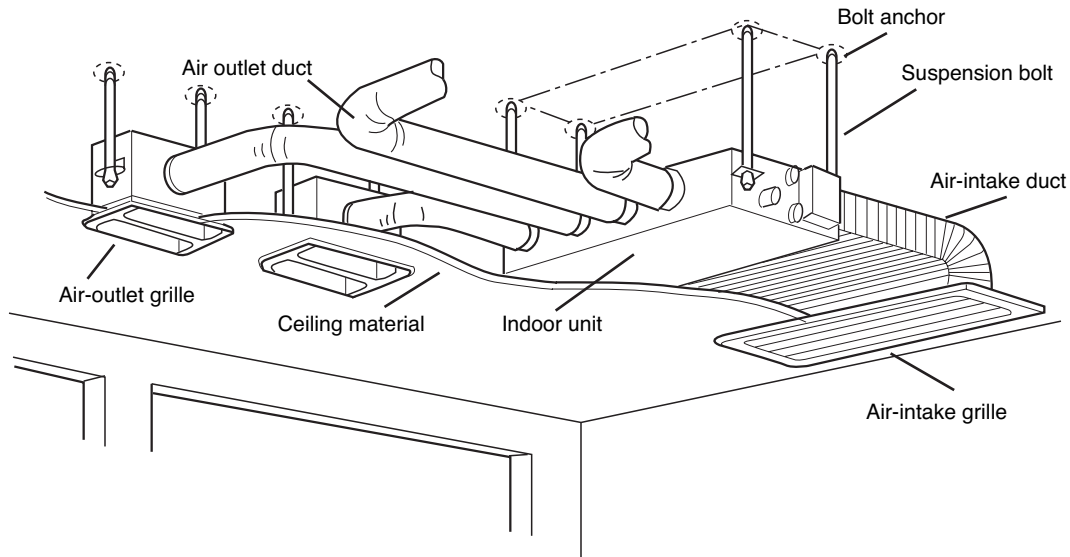

Fig. 3-97



3-24. Installing the Drain Piping

- (1) Prepare standard hard PVC pipe for the drain and use the supplied hose band to prevent water leaks. The PVC pipe must be purchased separately. When doing this, leave a gap between the drain socket of the unit and the PVC pipe to allow the drainage to be checked. The transparent drain pipe allows you to check drainage. (Fig. 3-98)

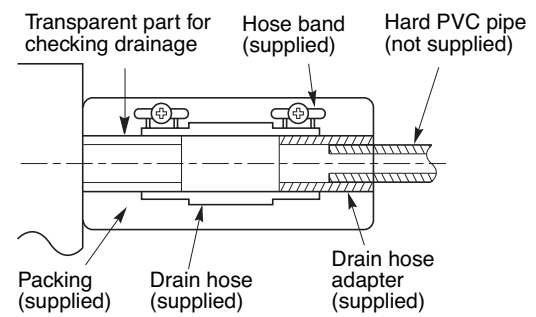

Fig. 3-98



CAUTION Tighten the hose clamps so their locking nuts face upward. (Fig. 3-98)

- (2) After connecting the drain piping securely, wrap the supplied packing and drain pipe insulator around the pipe, then secure it with the supplied clamps. (Fig. 3-99)

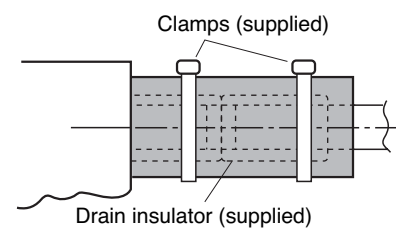
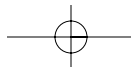

Fig. 3-99

NOTE

Make sure the drain pipe has a downward gradient (1/100 or more) and that there are no water traps.



**CAUTION**

- Do not install an air bleeder tube as this may cause water to spray from the drain pipe outlet. (Fig. 3-100)
- If it is necessary to increase the height of the drain pipe, the section directly after the connection port can be raised a maximum of 19-11/16 in. Do not raise it any higher than 19-11/16 in., as this could result in water leaks. (Fig. 3-101)
- Do not install the pipe with an upward gradient from the connection port. This will cause the drain water to flow backward and leak when the unit is not operating. (Fig. 3-102)
- Do not apply force to the piping on the unit side when connecting the drain pipe. The pipe should not be allowed to hang unsupported from its connection to the unit. Fasten the pipe to a wall, frame, or other support as close to the unit as possible. (Fig. 3-103)

U

3-25. Checking the Drainage

After wiring and drain piping are completed, use the following procedure to check that the water will drain smoothly. For this, prepare a bucket and wiping cloth to catch and wipe up spilled water.

- (1) Connect power to the power terminal board (L1, L2 terminal) inside the electrical component box.
- (2) Remove the tube cover and through the opening, slowly pour about 43 oz. of water into the drain pan to check drainage.
- (3) Short the check pin (CN5 white) on the indoor control board and operate the drain pump. Check the water flow and see if there is any leakage.

**CAUTION**

Be careful since the fan will start when you short the pin on the indoor control board.

- (4) When the check of drainage is complete, open the check pin (CN5 white) and remount the insulator and drain cap onto the drain inspection port.

**CAUTION**

To mount the tube cover, use 5/16" (4 × 8 mm) tapping screws. Do not use long screws as they may puncture the drain pan and cause water leak-age.

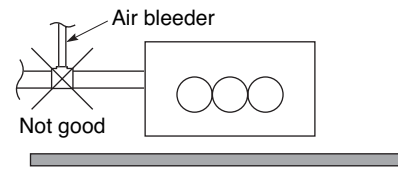
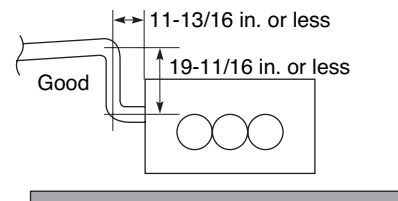
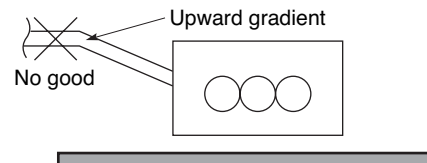
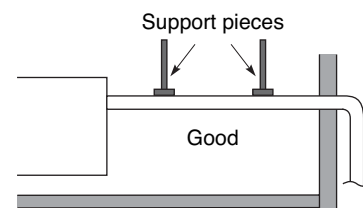
**Fig. 3-100****Fig. 3-101****Fig. 3-102****Fig. 3-103**

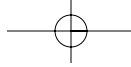

3-26. Increasing the Fan Speed

If external static pressure is too great (due to long extension of ducts, for example), the air flow volume may drop too low at each air outlet. This problem may be solved by increasing the fan speed using the following procedure:

- (1) Remove 4 screws on the electrical component box and remove the cover plate.
- (2) Disconnect the fan motor sockets in the box.
- (3) Take out the booster cable (sockets at both ends) clamped in the box.
- (4) Securely connect the booster cable sockets between the disconnected fan motor sockets in step 2 as shown in the Fig. 3-104.
- (5) Place the cable neatly in the box and reinstall the cover plate.

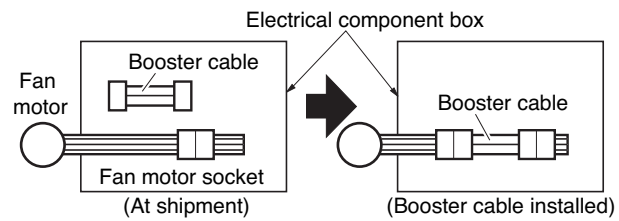

Fig. 3-104



How to read the diagram

The vertical axis is the external static pressure (Pa) while the horizontal axis represents the air flow (CFM).

The characteristic curves for "HT", "H", "M" and "L" fan speed control are shown.

The nameplate values are shown based on the "H" air flow. For the 26 type, the air flow is 636 CFM, while the external static pressure is 49 Pa at "H" position. If external static pressure is too great (due to long extension of duct, for example), the air flow volume may drop too low at each air outlet. This problem may be solved by increasing the fan speed as explained above.

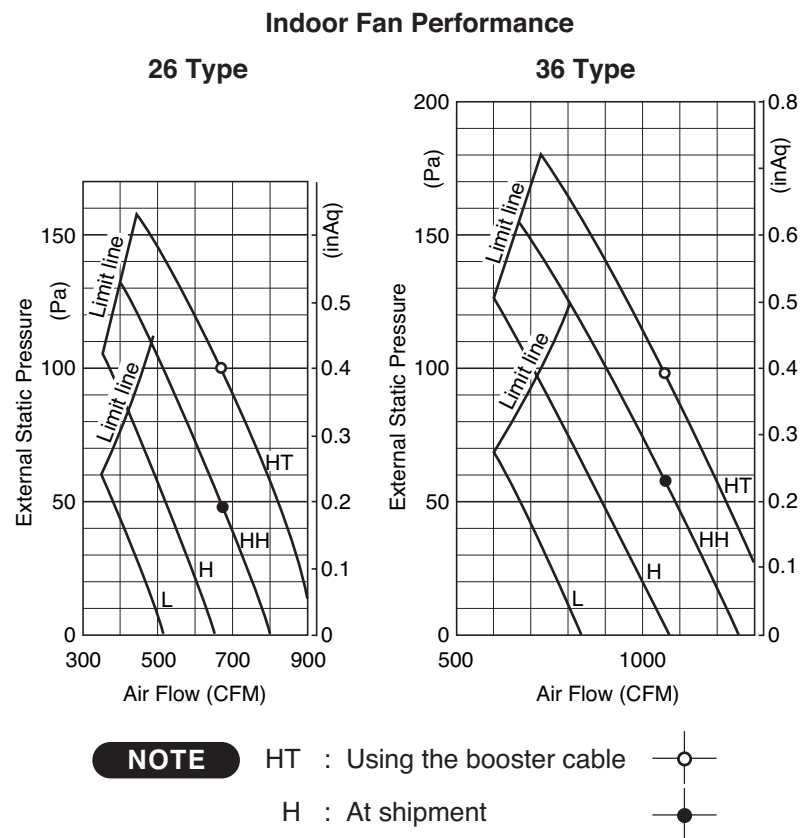
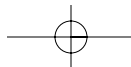
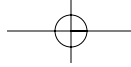

Fig. 3-105





4. HOW TO INSTALL THE OUTDOOR UNIT

4-1. Installing the Outdoor Unit

- Use concrete or a similar material to create the base, and ensure good drainage.
- Ordinarily, ensure a base height of 2 in. or more. If a drain pipe is used, or for use in cold-weather regions, ensure a height of 6 in. or more at the feet on both sides of the unit. (In this case, leave clearance below the unit for the drain pipe, and to prevent freezing of drainage water in cold-weather regions.)
- Refer to the Fig. 4-1 for the anchor bolt dimensions.
- Be sure to anchor the feet with the anchor bolts (M10). In addition, use anchoring washers on the top side. (Use large square 32 × 32 SUS washers with diameters of 10.) (Field supply)

4-2. Drainage Work

Follow the procedure below to ensure adequate draining for the outdoor unit.

- For the drain port dimensions, refer to the figure at right.
- Ensure a base height of 6 in. or more at the feet on both sides of the unit.
- When using a drain pipe, install the drain socket (optional part STK-DS25T) onto the drain port. Seal the other drain port with the rubber cap supplied with the drain socket.
- For details, refer to the instruction manual of the drain socket (optional part STK-DS25T).

4-3. Routing the Tubing and Wiring

- The tubing and wiring can be extended out in 4 directions: front, rear, right, and down.
 - The service valves are housed inside the unit. To access them, remove the inspection panel. (To remove the inspection panel, remove the 3 screws, then slide the panel downward and pull it toward you.)
- (1) If the routing direction is through the front, rear, or right, use a nipper or similar tool to cut out the knockout holes for the inter-unit control wiring outlet, power wiring outlet, and tubing outlet from the appropriate covers A and B.
 - (2) If the routing direction is down, use a nipper or similar tool to cut out the lower flange from cover A.



CAUTION

- **Route the tubing so that it does not contact the compressor, panel, or other parts inside the unit. Increased noise will result if the tubing contacts these parts.**
- **When routing the tubing, use a tube bender to bend the tubes.**

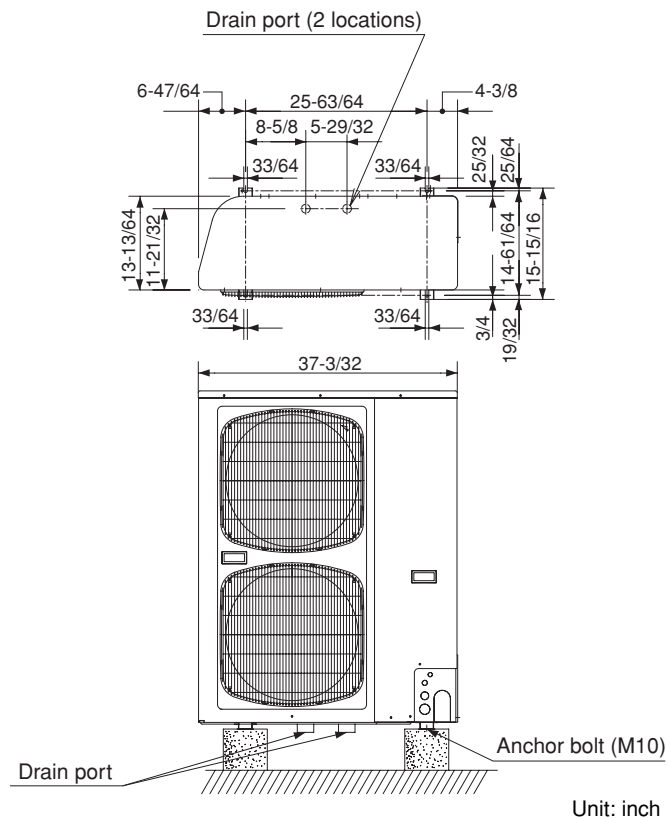

Fig. 4-1

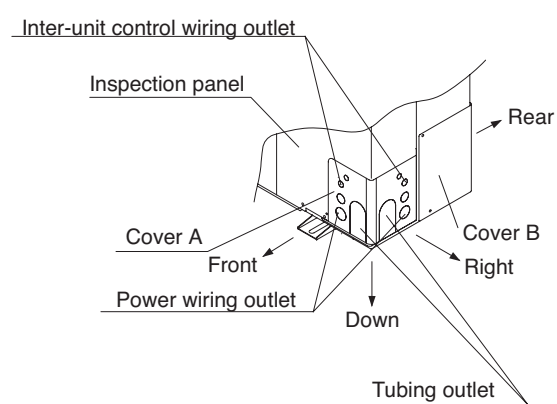
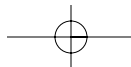
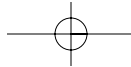

Fig. 4-2





5. ELECTRICAL WIRING

5-1. General Precautions on Wiring

- (1) Before wiring, confirm the rated voltage of the unit as shown on its nameplate, then carry out the wiring closely following the wiring diagram.
- (2) Provide a power outlet to be used exclusively for each unit, and a power supply disconnect and circuit breaker for overcurrent protection should be provided in the exclusive line.
- (3) To prevent possible hazards from insulation failure, the unit must be grounded.
- (4) Each wiring connection must be done in accordance with the wiring system diagram. Wrong wiring may cause the unit to misoperate or become damaged.
- (5) Do not allow wiring to touch the refrigerant tubing, compressor, or any moving parts of the fan.
- (6) Unauthorized changes in the internal wiring can be very dangerous. The manufacturer will accept no responsibility for any damage or misoperation that occurs as a result of such unauthorized changes.
- (7) Regulations on wire diameters differ from locality to locality. For field wiring rules, must follow your LOCAL ELECTRICAL CODES before beginning. You must ensure that installation complies with all relevant rules and regulations.
- (8) To prevent malfunction of the air conditioner caused by electrical noise, care must be taken when wiring as follows:
 - The remote control wiring and the inter-unit control wiring should be wired apart from the inter-unit power wiring.
 - Use shielded wires for inter-unit control wiring between units and ground the shield on both sides.
- (9) If the power supply cord of this appliance is damaged, it must be replaced by a repair shop appointed by the manufacturer, because special-purpose tools are required.
- (10) All wiring used must be Class 1.

5-2. Recommended Wire Length and Wire Diameter for Power Supply System

You must follow LOCAL ELECTRICAL CODES for wiring.

Outdoor Unit

* AWG = American Wire Gauge

Model Name	(A) Power Supply	Trade Size of Conduit	MOP (Fuse or HACR type circuit breaker)	Power Supply Terminal Base		Trade Size of Conduit
				Capacity	Max. Wire Diameter	
CH2672R	AWG #12 Max. length 64 ft.	3/4 in.	30 A	50 A	AWG #6	1-1/4 in.
CH3072R	AWG #10 Max. length 92 ft.	3/4 in.	35 A (230/208 V)	50 A	AWG #6	1-1/4 in.
CH3672R	AWG #10 Max. length 92 ft.	3/4 in.	35 A (230/208 V)	50 A	AWG #6	1-1/4 in.
CH4272R	AWG #10 Max. length 81 ft.	3/4 in.	40 A	50 A	AWG #6	1-1/4 in.

Model Name	(A) Power Supply	Trade Size of Conduit	MOP (Fuse or HACR type circuit breaker)	Power Supply Terminal Base		Trade Size of Conduit
				Capacity	Max. Wire Diameter	
C2672R	AWG #12 Max. length 76 ft.	3/4 in.	25 A	50 A	AWG #6	1-1/4 in.
C3072R	AWG #10 Max. length 99 ft.	3/4 in.	30 A (230/208 V)	50 A	AWG #6	1-1/4 in.
C3672R	AWG #10 Max. length 99 ft.	3/4 in.	30 A (230/208 V)	50 A	AWG #6	1-1/4 in.
C4272R	AWG #10 Max. length 81 ft.	3/4 in.	35 A	50 A	AWG #6	1-1/4 in.

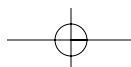

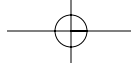

Indoor Unit

Type	(B) Power Supply AWG #14	Trade Size of Conduit	MOP (Fuse or HACR type circuit breaker)
X, K, T, U	Max. length 67 ft.	3/4 in.	15 A

Control Wiring

(C) Inter-Unit Control Wiring	(D) Remote Control Wiring	(E) Control Wiring For Group Control
AWG #18 Use high voltage wire (300 V) ^{*1}	AWG #18 ^{*2} (0.75 mm ²)	AWG #18 ^{*2} - (0.75 mm ²)
Max. 3,300 ft.	Max. 1,650 ft.	Max. 1,650 - ft. (Total)

*1 With ring-type wire terminal.
*2 Wire joint connection.

5-3. Wiring System Diagrams

Basic wiring diagram for standard control

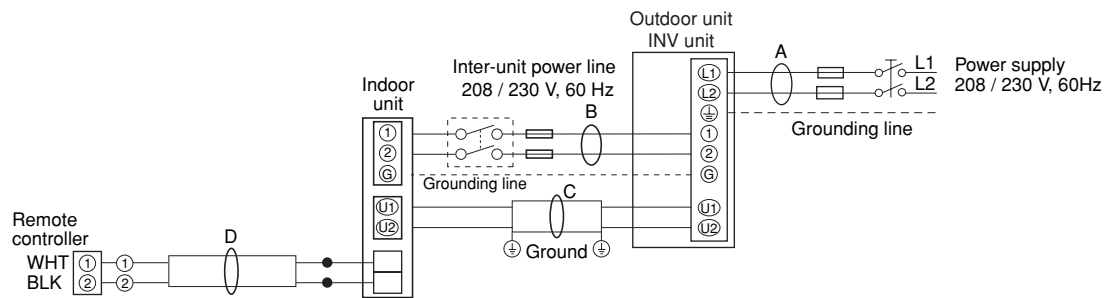

NOTE

- Refer to Section 5-2. Recommended Wire Length and Wire Diameter for Power Supply System for the explanation of "A", "B", "C", "D", and "E", in the above diagrams.
- Inter-Unit Control Wiring (C) and remote controller wiring (D), (E) have no polarity. But for other wiring, respect polarity. Be sure to connect as shown in the Wiring System Diagram.
- In case of separate supply connection to indoor unit, over current protection must be provided between power source and indoor unit.

MAXIMUM OVER CURRENT PROTECTION 15 A (FUSE OR HACRTYPE CIRCUIT BREAKER)

CH Type

8P terminal board

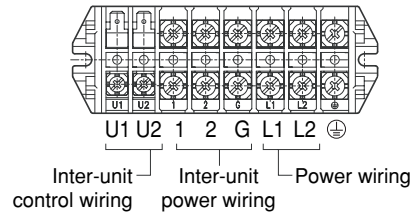

X, T, U Type

5P terminal board

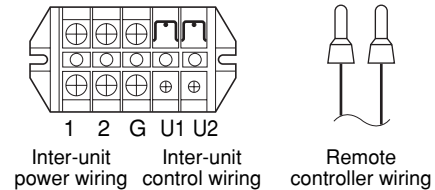

K Type

4P terminal board

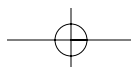
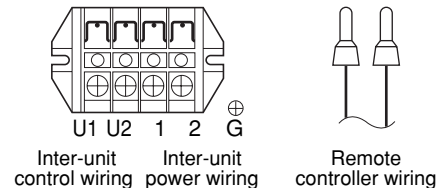

**WARNING**

Loose wiring may cause the terminal to overheat or result in unit malfunction. A fire hazard may also exist. Therefore, ensure that all wiring is tightly connected.

When connecting each power wire to the corresponding terminal, follow the instructions on "How to connect wiring to the terminal" and fasten the wire securely with the fixing screw of the terminal plate.

5-4. How to Connect Wiring to the Terminal

■ For stranded wiring

- (1) Cut the wire end with a wire cutter or wire-cutting pliers, then strip the insulation to expose the stranded wiring about 3/8 in. (Fig. 5-1)
- (2) Using a Phillips head screwdriver, remove the terminal screw(s) on the terminal plate.
- (3) Using a ring connector fastener or pliers, securely clamp each stripped wire end with a ring pressure terminal. (Fig. 5-1)
- (4) Place the ring pressure terminal, and replace and tighten the removed terminal screw using a screwdriver. (Fig. 5-2)

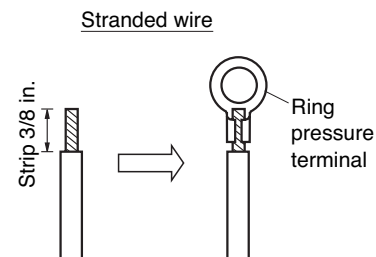

Fig. 5-1

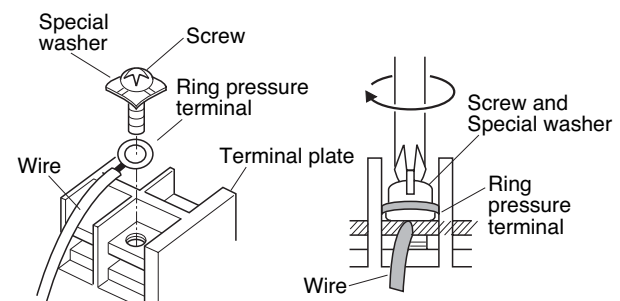
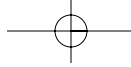

Fig. 5-2



6. HOW TO INSTALL THE WIRED REMOTE CONTROLLER (OPTIONAL PART)

6-1. Installation Site Selection

- Install the remote controller at a height of between 3–5 ft. above the floor.
- Do not install the remote controller in a place where it will be exposed to direct sunlight or near a window or other place where it will be exposed to the outside air.
- Be sure to install the remote controller vertically, such as on a wall.
- The mounting position for the remote controller should be located in an accessible place for control.
- Never cover the remote controller or recess it into the wall.

Drainage Work

- When mounting the remote controller on a wall, refer to Figs. 6-1 and 6-2.

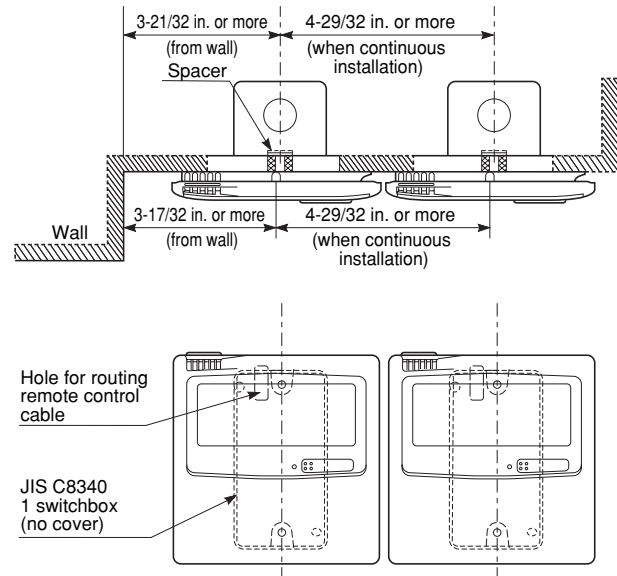

Fig. 6-1

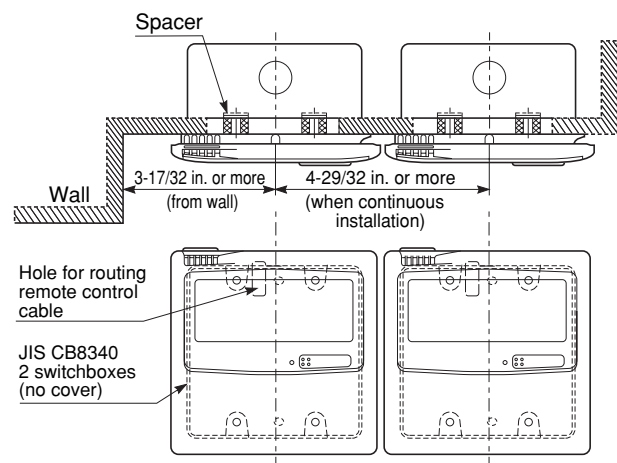
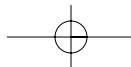

Fig. 6-2

RC
(WD)



6-2. Wired Remote Controller Installation



WARNING

- Do not supply power to the unit or try to operate it until the tubing and wiring to the outdoor unit are completed.



CAUTION

- Do not twist the control wiring with the power wiring or run it in the same metal conduit, because this may cause malfunction.
- Install the remote controller away from sources of electrical noise.
- Install a noise filter or take other appropriate action if electrical noise affects the power supply circuit of the unit.
- If local electrical codes allow, this remote controller can be mounted using a conventional wall box for flush mounting.

- (1) When you open the decorative cover, you will see two gaps under the remote controller. Insert a coin into these gaps and pry off the back case. (Fig. 6-4)

- (2) Attach the back case with the 2 small screws provided. Using a screwdriver, push open the cut-outs on the back case. These holes are for screws. Use the spacers and take care not to tighten the screws excessively. If the back case will not seat well, cut the spacers to a suitable thickness. (Fig. 6-3)

- (3) Connect the remote controller wiring (2 wires) correctly to the corresponding terminals in the electrical component box of the indoor unit.



CAUTION

When wiring, do not connect the remote controller wires to the adjacent terminal block for the power wiring. Otherwise, the unit will break down.

- (4) To finish, fit the back tabs of the case into the remote controller and mount it.

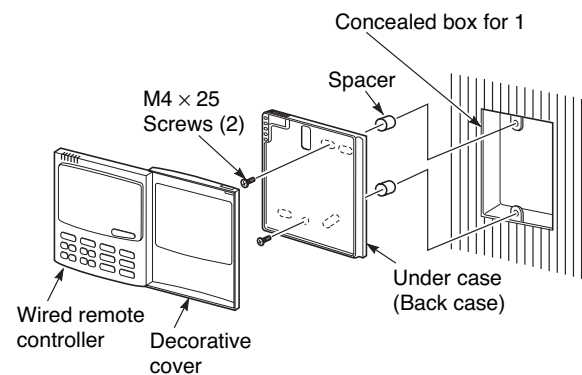

Fig. 6-3

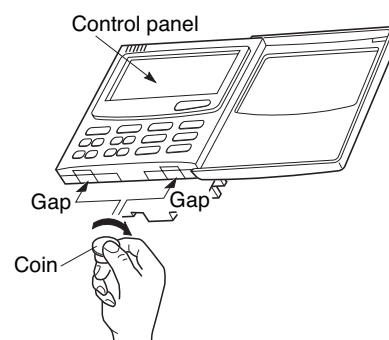
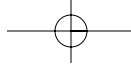
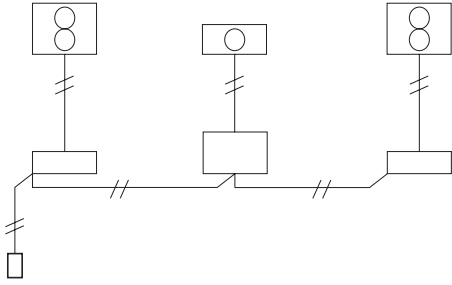

Fig. 6-4

RC
(WD)



6-3. Basic Wiring Diagram



CAUTION

Carry out wiring correctly (incorrect wiring will damage the equipment).

Use shielded wires for inter-unit control wiring and ground the shield on both sides. (Fig. 6-5)
Otherwise misoperation because of noise may occur.

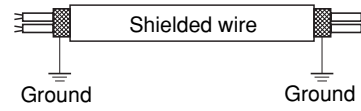

Fig. 6-5

■ Wiring procedure

Install the wiring according to the above wiring diagram.

- Address setting is automatically executed after turning on the system.
An indoor unit address is assigned to each indoor unit.
- Operation takes place successively at intervals of 1 second, by using combinations of the address setting of each unit.

■ Diagram of outer dimensions

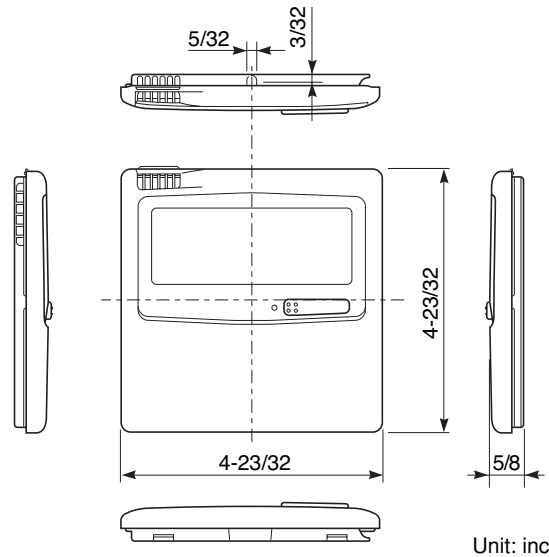

Unit: inch

**RC
(WD)**

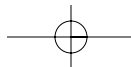

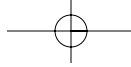

6-4. Wiring System Diagram for Group Control

This diagram shows when several units (maximum of 8) are controlled by a remote controller (main unit).

In this case, a remote controller can be connected at any indoor unit.

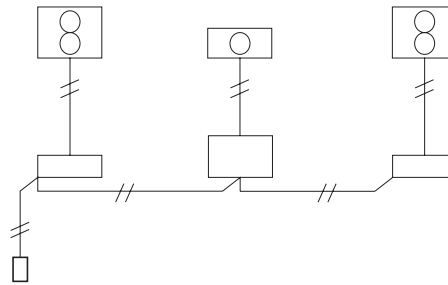

■ Wiring procedure

Wire according to the diagram at right:

- Address setting is executed automatically when the outdoor unit is turned on.

■ Group control using 2 remote controllers

It does not matter which of the 2 remote controllers you set as the main controller.

When using multiple remote controllers (up to 2 of them can be used), one is the main remote controller and the other is the sub-remote controller.

- To set up a sub-remote controller, change its remote control address connector (RCU. ADR) located on its PCB from main to sub position (main: when shipped from factory).

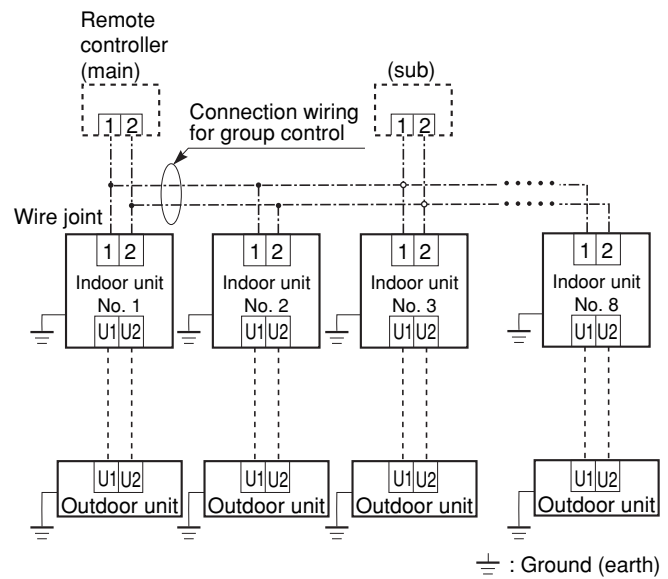
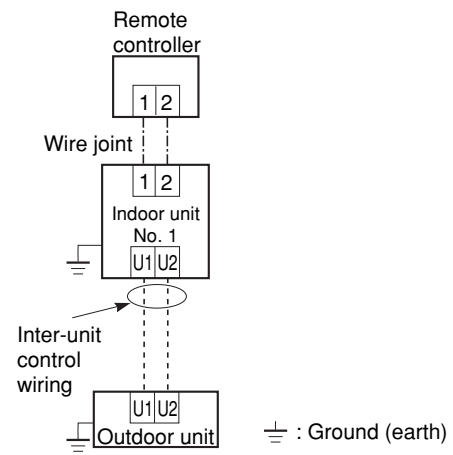

**RC
(WD)**

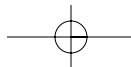

6-5. Wiring System Diagram for Multiple Remote Controllers

■ When Installing Multiple Remote Controllers

This multiple remote controller system is used for operating the unit(s) at different positions. (A maximum of 2 remote controllers can be installed.)

● Setting method

To execute this control, make the setting according to the following procedure.

- (1) Of the 2 installed remote controllers, make 1 the main remote controller (factory-shipped state).
- (2) On the other remote controller, change the address connector on the PCB from main to sub position. In this state, it functions as a sub-remote controller.

● Basic wiring diagram



CAUTION

**Install wiring correctly
(incorrect wiring will damage
the equipment).**

To operate 1 indoor unit with 2 remote controllers set at different places.

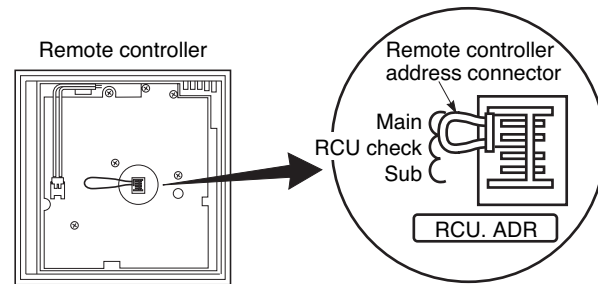

**RC
(WD)**

6-6. How to Switch the Indoor Temperature Sensor

The indoor unit and the remote controller both contain an indoor temperature sensor. The sensors on either unit can be used but normally only the sensor set on the indoor unit is used. However, use the following procedure if you must use the sensor on the remote controller.

- (1) Press and hold the + **SET** + **CL** buttons for at least 4 seconds.
Note: The Unit No. first displayed is the main indoor unit address for group control.
Note: Do not press the **UNIT** button.
- (2) Select CODE NO. 32 with the Temp. setting () / buttons.
- (3) Change the set data from 0000 to 0001 with the Timer () / buttons.
- (4) Press the **SET** button. (Setting is OK if the blinking display changes to a lit up display.)
- (5) This is the usual off condition. At this time, (remote controller) appears on the LCD display.

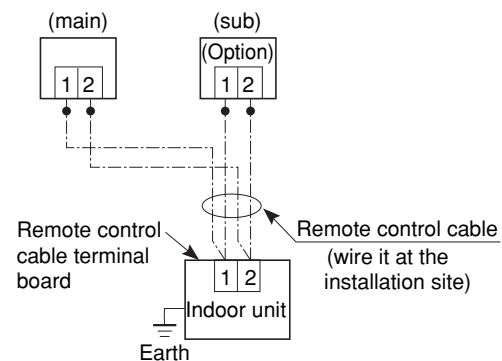

NOTE

- *1 If using 2 remote controllers, either one (main or sub-remote controller) can be used to make settings but only the main unit functions as the remote controller sensor.
- *2 The remote controller sensor will not function during group control unless the group address is set in the main remote controller indoor unit.
- *3 Do not use the remote controller switch for the remote control sensor if the remote sensor is being used jointly with the remote controller switch.

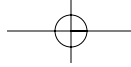

6-7. Trouble Diagnostics

(1) Contents of remote controller switch alarm display

ON: ○ Blinking: ☀ OFF: ●

Possible cause of malfunction			Wired remote control display	Wireless remote controller receiver display		
				Operation	Timer	Standby
Serial communication errors Mis-setting	Remote controller is detecting error signal from indoor unit	Error in receiving serial communication signal (Signal from main indoor unit in case of group control) Outdoor system address, indoor system address, or indoor unit individual/main/sub setting is not set (Automatic address setting is not completed) Auto address is not completed	E01			
		Error in transmitting serial communication signal	E02	☀	●	●
	Indoor unit is detecting error signal from remote controller (and system controller)		E03			
	Improper setting of indoor unit or remote controller	Indoor unit address setting is duplicated	E08			
		Remote controller setting is duplicated	E09			
	Indoor unit is detecting error signaled from signal option	Error in transmitting serial communications signal	E10			
		Error in receiving serial communications signal	E11			
	Setting error	Main unit duplication in simultaneous-operation multi control (detected by outdoor unit)	E14			
	Indoor unit is detecting error signaled from outdoor unit	Error in receiving serial communications signal	E04			
		Error in transmitting serial communications signal	E05			
	Outdoor unit is detecting error signaled from indoor unit	Error in receiving serial communications signal (including unit quantity verification failure)	E06	●	●	☀
		Error in transmitting serial communications signal	E07			
	Automatic address setting failed	Indoor unit capacity too low	E15			
		Indoor unit capacity too high	E16			
		No indoor units connected	E20			
An indoor unit detected trouble in the signal from another indoor unit	Error in transmitting serial communications signal	E17	☀	●	●	
	Error in receiving serial communications signal	E18				
Communications trouble between units	Communications failure with MDC	E31	●	●	☀	
Mis-setting	Setting error	Indoor unit group settings error	L01			
		Indoor/outdoor unit type mismatch	L02	☀	●	☀
		Main unit duplication in group control (detected by indoor unit)	L03	└ Simultaneously ┘		
		Outdoor unit address duplication (system address)	L04	☀	○	☀
		Group wiring connected for independent indoor unit	L07	└ Simultaneously ┘		
		Address not set or group not set	L08	☀	●	☀
		Indoor unit capacity not set	L09	└ Simultaneously ┘		
		Outdoor unit capacity not set or setting error	L10	☀	○	☀
		Miswiring in group control wiring	L11	└ Simultaneously ┘		
Indoor unit type setting error (capacity)	L13					

RC (WD)

Continued

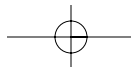

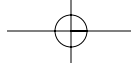

Possible cause of malfunction			Wired remote control display	Wireless remote controller receiver display		
				Operation	Timer	Standby
Ceiling panel connection failure			P09			
Activation of protective device	Indoor protection	Fan protective thermostat	P01	●	☀	☀
		Float switch	P10	└ Alternately ┘		
	Outdoor protection	Discharge temperature trouble	P03			
		High pressure switch or compressor motor thermal protector is activated.	P04			
		Open phase detected, AC power trouble	P05			
		No gas	P15			
		4-way valve locked	P19	☀	●	☀
		High cooling load	P20	└ Alternately ┘		
		Outdoor fan trouble	P22			
		Inverter compressor trouble (HIC PCB)	P26			
		Inverter compressor trouble (MDC)	P29			
		Simultaneous-operation multi control trouble	P31			
	Compressor current failure (overload)	H01	●	☀	●	
	Thermistor fault	Thermistor open circuit • Short circuit (indoor)	Indoor heat exchanger temperature sensor (E1)	F01		
Indoor heat exchanger temperature sensor (E2)			F02	☀	☀	●
Indoor temperature sensor			F10	└ Alter. ┘		
Thermistor open circuit • Short circuit (outdoor)		Discharge temperature (TD)	F04			
		Outdoor heat exchanger temperature (C1)	F06			
		Outdoor heat exchanger temperature (C2)	F07	☀	☀	○
		Outdoor air temperature (TO)	F08	└ Alter. ┘		
		Intake temperature (TS)	F12			
		Indoor EEPROM error	F29	☀	☀	●
		Outdoor EEPROM error	F31	☀	☀	○
				└ Simul. ┘		

**RC
(WD)**

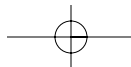

(2) LED Indicator Messages on Outdoor Control PCB

	LED 1	LED 2	Remarks
Power ON sequence 1. No communication from indoor units in system 2. Communication received from 1 or more indoor units in system 3. Regular communication OK (Capacity and unit quantity match)	○ ● ●	○ ● ●	If it is not possible to advance to 3, repeats 1 → 2. At 3, changes to normal control.
Normal operation EEPROM error (F31) Pre-trip (insufficient gas) Pre-trip (P20) Pre-trip (other)	○ ☀ (0.25/0.75) ☀ (0.75/0.25) ☀	☀ ● ● ●	Displayed during automatic address setting 1 and initial communication. After these are completed, alarm F31 is displayed. P03
Alarm	Alternate blinking during alarms LED 1 blinks M times, then LED 2 blinks N times. The cycle then repeats. M = 2: P alarm 3: H alarm 4: E alarm 5: F alarm 6: L alarm N = Alarm No. * Refer to "1. Examples of alarm display" below.		
Insufficient gas indicator	☀	●	
Refrigerant recovery mode	☀	●	
Automatic address setting Automatic address setting in progress Automatic address setting alarm (E15) Automatic address setting alarm (E20) Automatic address setting alarm (Other than E15 and E20)	☀ ☀ (0.25/0.75) ☀ (0.75/0.25) ☀	☀ ☀ (0.25/0.75) ☀ (0.75/0.25) ☀	Blinking alternately Blinking simultaneously Blinking simultaneously Blinking simultaneously

- : ON
- ☀ : **Blinking (0.25/0.75)** indicates that the lamp illuminates for 0.25 seconds, and then is OFF for 0.75 seconds. Unless otherwise indicated, the blinking is (0.5/0.5).
- : OFF

(3) Examples of alarm display (other than E15, E16, and E20)

Alarm / Display	LED 1 ← Alternately → LED 2
P03	☀ (Blinks 2 times) ☀ (Blinks 3 times)
P04	☀ (") ☀ (Blinks 4 times)
P05	☀ (") ☀ (Blinks 5 times)
P31	☀ (") ☀ (Blinks 31 times)
H01	☀ (Blinks 3 times) ☀ (Blinks 1 time)
H02	☀ (") ☀ (Blinks 2 times)
H03	☀ (") ☀ (Blinks 3 times)
.	.
E04	☀ (Blinks 4 times) ☀ (Blinks 4 times)
.	.
F07	☀ (Blinks 5 times) ☀ (Blinks 7 times)
.	.
L13	☀ (Blinks 6 times) ☀ (Blinks 13 times)
.	.

Note:
This table shows example alarms. Other alarms may also be displayed.

RC
(WD)

7. HOW TO INSTALL THE WIRELESS REMOTE CONTROLLER (ACCESSORY PART / OPTIONAL PART)

IMPORTANT

When using this air conditioner with the wireless remote controller it may sometimes be impossible to change the operation modes while other indoor unit is running.

- When this happens, a double beep tone sounds, the \odot (operation lamp) lights up, and the \ominus (Timer lamp) and \otimes (Standby lamp) blink alternately. Operation is the same even during (AUTO mode) automatic cooling or heating.
- A beep tone sounds 5 times and no changes can be made when any of the ON/OFF, MODE, Temperature setting buttons were pressed while set under central control by the system controller.

7-1. Wireless Remote Controller Installation

The remote controller can be operated from either a non-fixed position or a wall-mounted position.

To ensure that the air conditioner operates correctly, do not install the remote controller in the following places:

- In direct sunlight.
- Behind a curtain or other place where it is covered.
- More than 26 ft. away from the air conditioner.
- In the path of the air conditioner's airstream.
- Where it may become extremely hot or cold.
- Where it may be subject to electrical or magnetic interference.

(1) If Wall-mounted Fixed Position

Install the remote controller at a convenient location on a nearby wall. However, before attaching the remote controller mounting cradle, check that the remote controller can operate from the desired wall position. (Fig. 7-1)

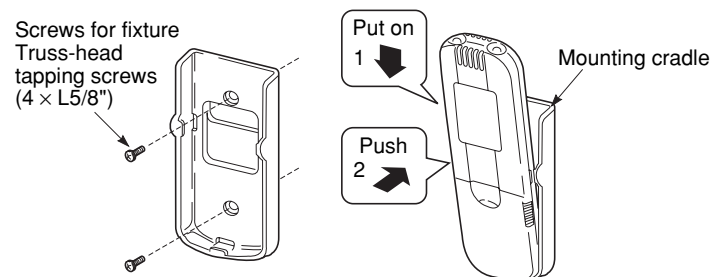

Fig. 7-1

● How to Install Batteries

See Fig. 7-2.

- (1) Press and slide the lid on the back of the remote controller in the direction of the arrow.
- (2) Install two AAA alkaline batteries. Make sure the batteries point in the direction marked in the battery compartment.
- (3) Press the ACL button, then replace the lid. If you press it, the current time, ON time, and OFF time are all reset to 0:00.

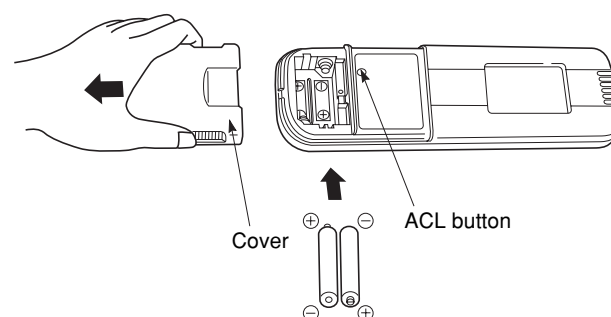
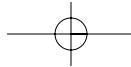

Fig. 7-2

RC
(WL)



7-2. Room Temperature Sensor Setting

The room temperature sensors are built into the indoor unit and the wireless remote controller. Either of these room temperature sensors can operate.

The system is shipped from the factory set to the indoor unit sensor. To switch to the remote controller sensor, press the sensor switching button located inside the remote controller cover and check that A/C SENSOR on the LCD display panel goes out.

NOTE

If the sensor switch is set to the remote controller side, but no room temperature data is sent to the main unit for 10 minutes, the sensor is automatically switched to the indoor unit side. As much as possible, install the remote controller facing the unit.

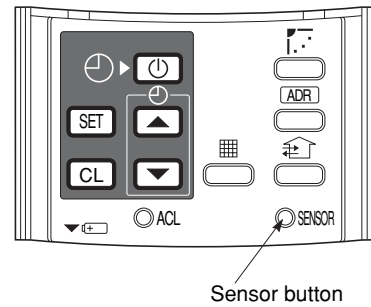

Fig. 7-3

7-3. Address Switches

If you are installing more than 1 indoor unit (up to 6) in the same room, it is necessary for you to assign each unit its own address so they each can be operated by their remote controller.

Up to 6 indoor units can be controlled separately through the address switches. The operating control has the reception address switch and the remote controller has the transmission address switch. This function is utilized by matching the transmission and reception address switches.

Remote controller address display	ADR ALL	ADR 1	ADR 2	...	ADR 6
Address switch positions	* Any address switch position available			...	

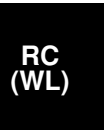

7-4. Setting the Model Code

① Flap display selector switch

Make the slide switch settings in the battery compartment box of the remote controller depending on the type of indoor unit in which the wireless receiving unit is used.

② Operation mode switch

In this Split System Air Conditioner set the switch to "A".

* The switch is factory set to "S" / "A".

* Always press the reset button after switching the setting.

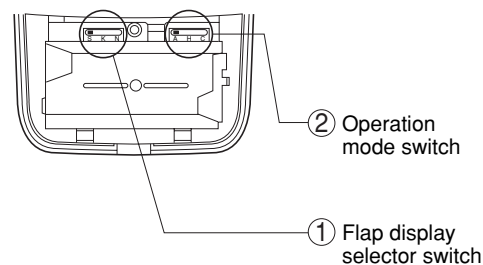
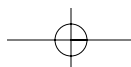

Fig. 7-4

①	X, T type	K type	U type
②	Heat pump with Auto mode (CH type)	Heat pump without Auto mode	Cooling only



X

<RCS-SH80UA.WL>

**■ 4-Way Air Discharge Semi-concealed Type
(X Type)**
7-5. Indicator Section Installation

- **Remove the ceiling panel and indicator cover and install the indicator section.**

- (1) Remove the ceiling panel.
- (2) Remove the corner cover behind the mark section. (3 screws)
- (3) Remove the mark section inside the ceiling panel. (2 screws)
- (4) Install the indicator section in the location where the mark section was attached. (2 screws)
- (5) Form the wire to match the panel ribs as shown in Fig. 7-6.
- (6) Install the corner cover. (Restrain the wire with the corner cover.)

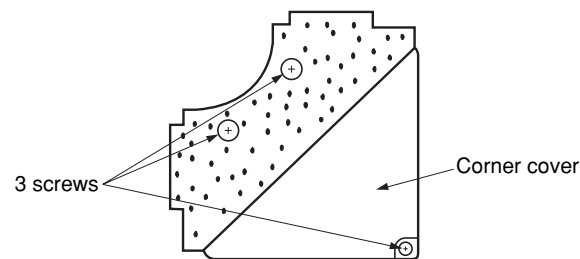
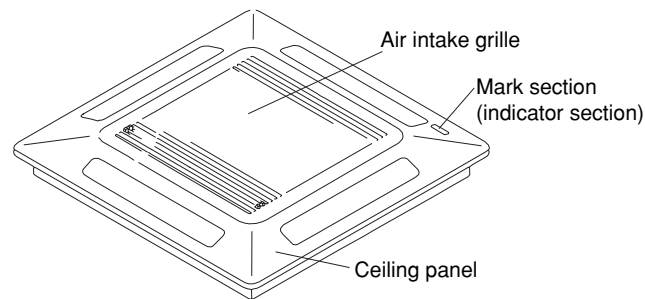

Fig. 7-5

7-6. Operating Controller Installation**CAUTION**

- **Do not twist the operating controller wires together with the power supply wires. Doing so can result in malfunction.**
- **If electrical noise is induced in the unit power supply, take appropriate measures, for example installing a noise filter.**

Install the operating controller at the indoor unit intake port section.

- (1) Fasten the operating controller to the indoor unit intake port section (electrical component box opposite side) with the 2 accessory screws (4 × L13/32 in.).
- (2) Connect the operating controller 2 wires (WHT, BLK) to the remote control wire (WHT) in the electrical component box. (For details on wiring, see “7-9. Electrical wiring” on page 72.)
- (3) Install the ceiling panel.
- (4) Connect the indicator section and the operating controller with the 6P connector (white).
- (5) Form the wires with vinyl clamps and fasten.
- (6) Connect the ceiling panel wiring connector (2P, 3P) to the body connector in the electrical component box.
- (7) For details on test operation, see “Test Run.”

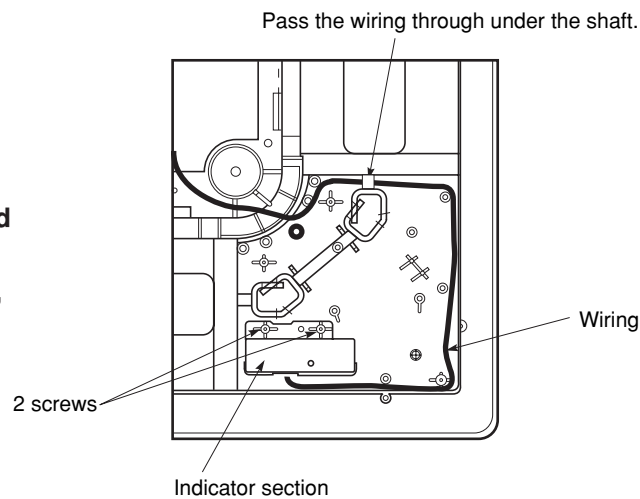

Fig. 7-6

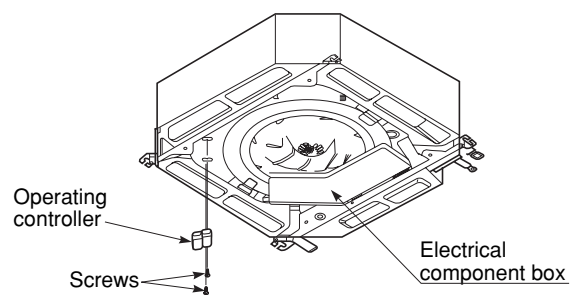
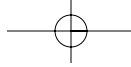

Fig. 7-7



■ Ceiling-Mounted Type (T Type)

7-7. Indicator Section Installation

Remove the side panel to install the indicator section.
(Fig. 7-8)

- (1) Remove the side panel.
Open the air intake grille, remove the screw at one place and then remove the side panel by sliding it toward the front (arrow direction).
- (2) Remove cover A and cover B.
Insert a standard screwdriver into the recess of cover A to remove cover A and cover B.
(When removing the cover, take care not to scratch the panel.)
- (3) Remove cover B from cover A.
- (4) Install the indicator section at cover A.
- (5) After passing through the lead wires, install cover A and the indicator section at the panel hole.
(The protrusion part of cover A is fixed with the panel hole.)
- (6) Bundle the lead wires along with the wiring of the louver motor.
- (7) Install the side panel.

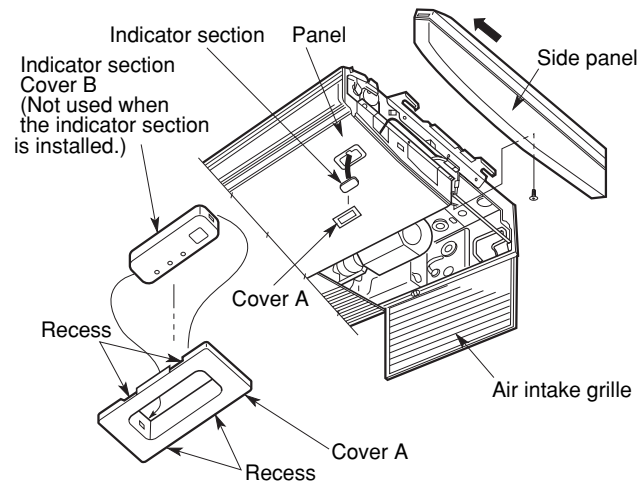

Fig. 7-8

T

7-8. Operating Controller Installation



- **Do not twist the operating controller wires together with the power supply wires. Doing so can result in malfunction.**
- **If electrical noise is induced in the unit power supply, take appropriate measures, for example installing a noise filter.**

Install the operating controller on the top face of the air intake section (space between the fan motor and the electrical component box). (Fig. 7-9)

- (1) Fasten the operating controller to the ceiling panel of the air intake section with the 2 supplied screws (4 × L13/32 in.).
- (2) Draw the lead wires into the electrical component box and connect the operating controller 2 wires (WHT, BLK) to the remote control wires in the electrical component box.
- (3) Connect the indicator section and the operating controller using the 6P connector in the electrical component box.

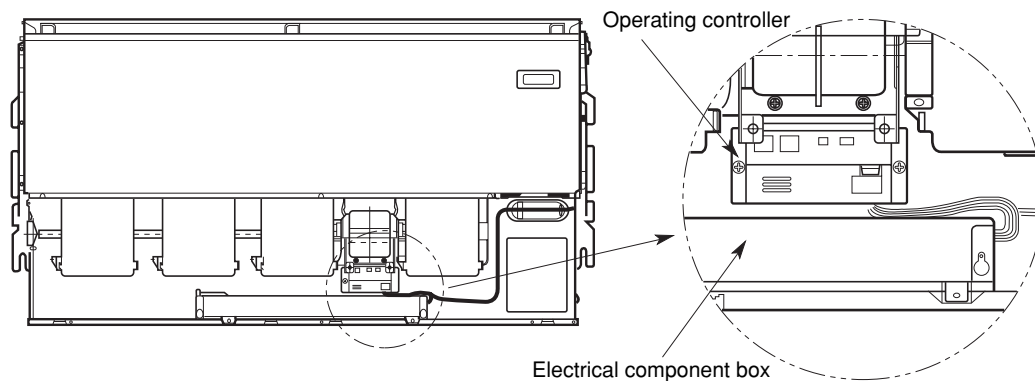
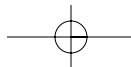

Fig. 7-9



7-9. Electrical Wiring

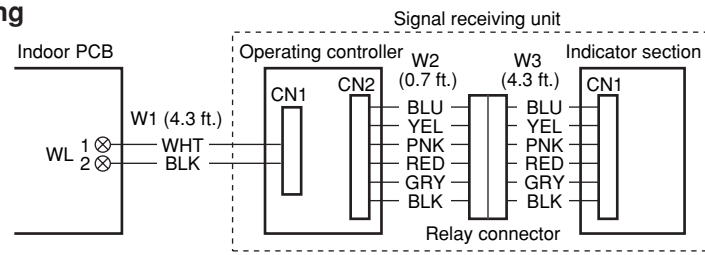

Fig. 7-10

Connection method

- (1) Connect W1 to the indoor PCB WL connector.
- (2) Connect W3 from the indicator section with W2 from the operating controller using the relay connector.

7-10. Test Run Switch

The test run switch is located in the operating control unit. Regarding the test run, refer to section 11. Test Run.

7-10-1. How to use the test run setting (X, T Types)

- (1) Set DIP switch [DS] No. 1 on the wireless receiver unit PCB from OFF to the ON position.
- (2) Press the ON/OFF operation button on the wireless remote controller.
- (3) Make a test run using the air conditioner in COOL or HEAT mode.
- (4) During the test run, each of the 3 indicator lamps on the indoor unit flash.
- (5) During the test run, the air conditioner runs continuously and the thermostat does not control the system.
- (6) After the test run, be sure to reset DIP switch No. 1 back to the OFF position and check that no indicator lamps are blinking.
(This receiver includes a 60-minute automatic OFF timer function in order to prevent continuous test run.)

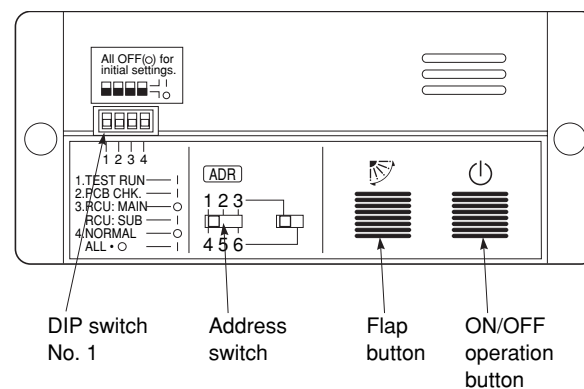
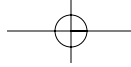

Fig. 7-11

RC
(WL)

NOTE

- In case of 4-way air discharge type, test run operation is not possible without the ceiling panel installation.
- To protect the air conditioner from overloading, the outdoor unit will not start running for 3 minutes after power is applied or the air conditioner is turned off and then back on.
- When the air conditioner fails to start the test run, 1 or more of the 3 alarm indicator lamps on the indoor unit will flash (See next section).
- When the DIP switch is set to "TEST – ON," temperature control from the wireless remote controller is disabled. Do not use this setting at any time other than for the test run. Doing so will place an excessive load on the system.
- To avoid placing an excessive load on the equipment, use this function only when conducting the test run.



7-11. Misoperation Alarm Indicators

Alarm indicator lamps on the indoor unit indicate the error cause if the air conditioner fails to operate upon being switched on. The possible alarm indications are given in Table 7-1. Fig. 7-12 shows the location of the alarm lamps on the indoor unit. (See Table 7-1 and Fig. 7-12.)

Table 7-1

Alarm			Cause of Trouble
⏻ (OPERATION lamp)	⌚ (TIMER lamp)	⊛ (STANDBY lamp)	
☀	●	●	S.C. errors* between the indoor unit's controller (PCB) and the remote controller.
●	☀	●	Compressor protector is working.
●	●	☀	S.C. errors between indoor and outdoor units.
☀	☀	●	Indoor or outdoor thermistor is malfunctioning.
☀	●	☀	Outdoor unit protector is working.
●	☀	☀	Indoor unit protector is working.
☀	☀	☀	TEST RUN switch on the operation controller is in ON state.

* S.C.: Serial communications

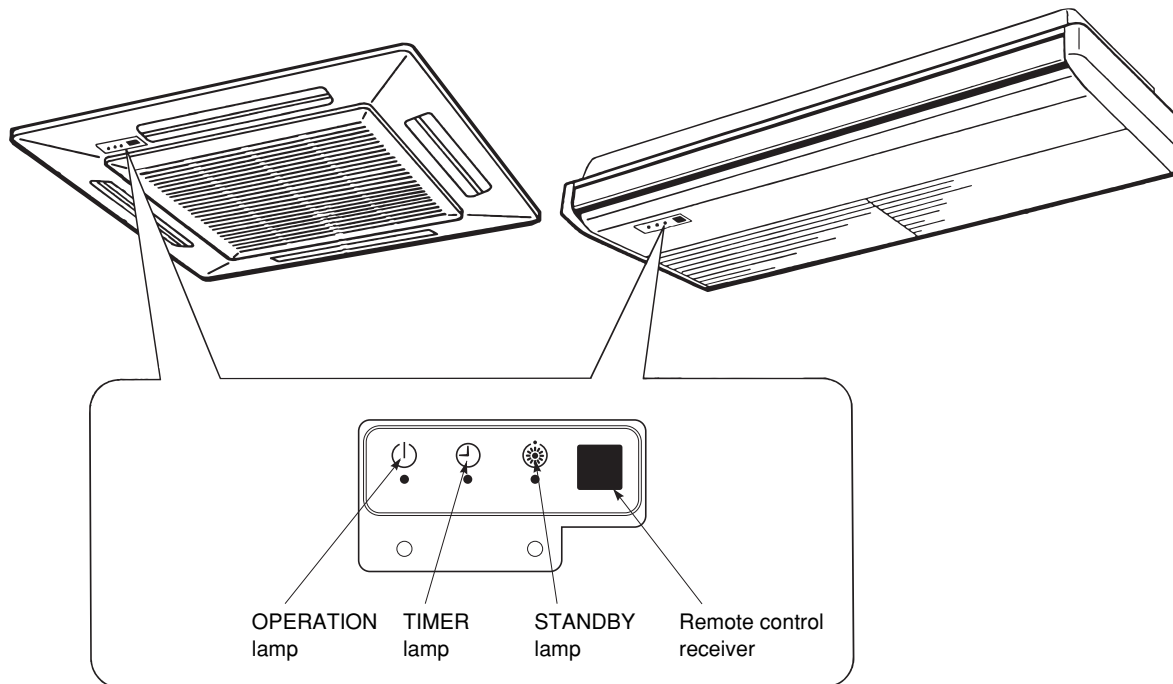
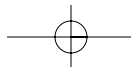

Fig. 7-12

NOTE

Stick the alarm message label accompanying the wireless remote controller on the electrical component box to indicate the cause of trouble for future reference.



<RCS-BH80UA.WL>



CAUTION

- If the signal receiving unit is installed near a rapid-start or inverter type fluorescent lamp (neither one uses glow lamps), it may be impossible to receive signals from the wireless remote controller. To avoid signal interference from fluorescent lamps, install the receiving unit at least 6.6 ft. away from the lamps and install at a location where wireless remote controller signals can be received when the fluorescent lamps are on.

7-12. Separate Type Signal Receiving Unit Installation



CAUTION

- Do not twist the operating controller wires together with the power supply wires. Doing so can result in malfunction.
- If electrical noise is induced in the unit power supply, take appropriate measures, for example installing a noise filter.

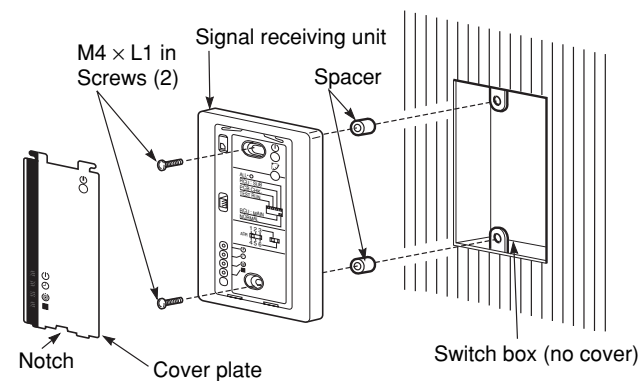

Fig. 7-13

- If local electrical codes allow, this signal receiving unit can be mounted using a conventional wall box for flush mounting.

- (1) Insert a standard screwdriver into the gap under the signal receiving unit and pry off the cover (Fig. 7-14)
- (2) Attach the signal receiving unit with the 2 small screws provided.
Use the spacers and take care not to tighten the screws excessively.
If the signal receiving unit will not seat well, cut the spacers to a suitable thickness. (Fig. 7-13)
- (3) Connect the signal receiving unit wiring (2 wires) correctly to the corresponding terminals in the electrical component box of the indoor unit.

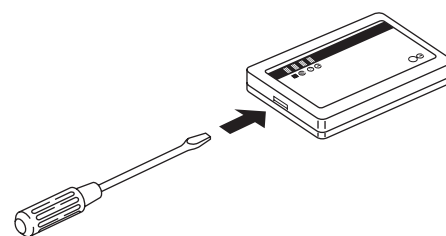

Fig. 7-14



CAUTION

When wiring, do not connect the signal receiving unit wires to the adjacent terminal block for the power wiring. Otherwise, the unit will break down.

RC
(WL)

- When using the signal receiving unit on a wall with the front exposed, choose a wall surface that the signal receiving unit can be mounted on.

- (1) Insert a standard (minus) screwdriver into the slot on the lower side of the signal receiving unit and pry off the back case as shown in Fig. 7-14.
- (2) The wire routing at the signal receiving unit comes out of the upper case (thin portion at upper center) so use nippers or a similar tool to cut out a notch beforehand large enough for the remote control cable (option) to pass through as shown in Fig. 7-15.
- (3) Remove the wire, which is connected prior to shipping, from the connector.
- (4) Connect the remote control cable (option) to the signal receiving unit connector as shown in Fig. 7-16 after the clamp (supplied) with the unit is installed.
- (5) After arranging the wiring on the printed circuit board as shown in Fig. 7-17 so that it is contained within the signal receiving unit, attach the back case. At this time, arrange so that the head of the clamp faces the side.
- (6) Remove the cover plate and install the signal receiving unit using the 2 wood screws.
- (7) Fasten to the wall using the cord clip (supplied).
- (8) Reinstall the cover plate.

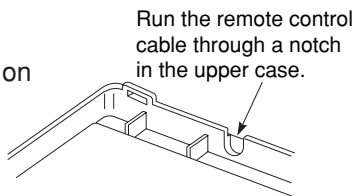

Fig. 7-15

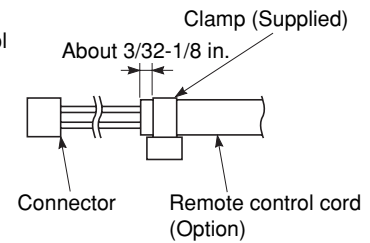

Fig. 7-16

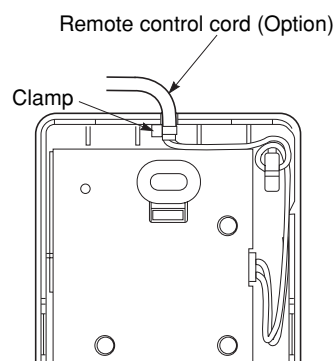

Fig. 7-17

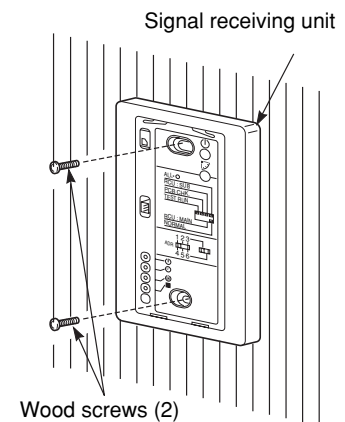

Fig. 7-18

- To use the signal receiving unit while mounted on the ceiling, install by using the carrier for ceiling installation supplied with the unit.

- (1) Remove the cover plate by inserting a standard (minus) screwdriver into the notch in the lower section and prying it off.
- (2) Cut out a section (3-3/4 x 2-1/32 in.) on the ceiling using the paper pattern (supplied) as a guide.
- (3) Run the wire through the mounting carrier and insert into the installation hole as shown in Fig. 7-19.
- (4) Fit securely into the ceiling material at sections (A) and (B) as shown in Fig. 7-20.
- (5) Connect the wire (2-wire core) from the signal receiving unit with the wire from the indoor unit. (See section on how to wire the receiving unit.) as shown in Fig. 7-20.
- (6) Use the supplied spacers to adjust for a thickness several inches more than the ceiling material and lightly fasten the receiving unit in place with the small screws (M4 x 1-9/16 in., 2 pcs.) supplied with the unit.
- (7) Tighten the machine screws after fitting sections (A) and (B) into the openings, in the gap between the signal receiving unit and ceiling surface as in Fig. 7-21. Do not apply strong force when tightening the screws. Excessive force might warp or damage the cover. When finished, the signal receiving unit should still be able to move slightly when pressed as shown in Fig. 7-21.
- (8) Reinstall the cover plate.

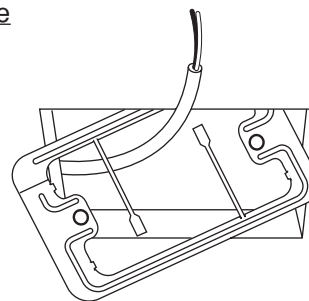

Fig. 7-19

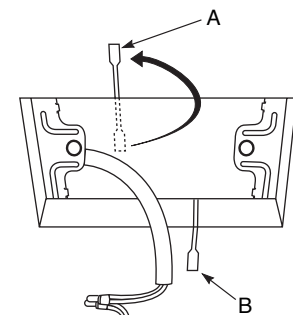

Fig. 7-20

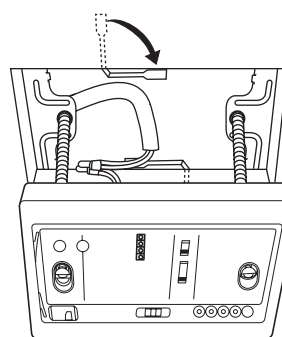
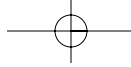

Fig. 7-21

RC
(WL)



7-13. Electrical Wiring



CAUTION

Be sure to do the wiring correctly (incorrect wiring will damage the equipment).

- Recommended wire diameter and allowable length for signal receiving unit wiring and its branch wiring:
AWG #18, MAX 1,300 ft.

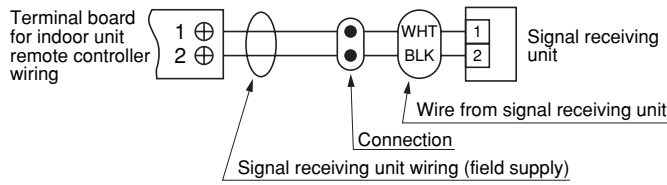

<p>Wire joint (2 pcs. white, supplied)</p>	<p>Signal receiving unit wiring</p> <p>Signal receiving unit wiring</p> <p>Wire joint CE-1 (supplied)</p>	<ol style="list-style-type: none"> 1. Peel away 9/16 in. of shield from the wire for the connection. 2. Join the 2 wires as shown and crimp-connect them with the wire joint (supplied). 3. When no crimping tool is available or if a solder connection was made, then cover with insulating tape.
--	---	--

7-14. Test Run Switch

- (1) Remove the cover plate of the signal receiving unit. Set the "TEST RUN" switch of the dip switches to the ON position.
- (2) Press the ON/OFF operation button on the wireless remote controller.



CAUTION

To avoid placing an excessive load on the equipment, use this function only when conducting the test run.

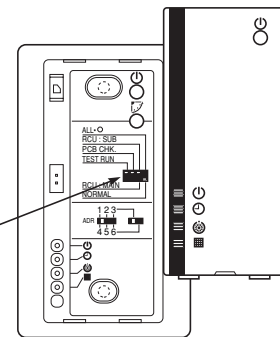
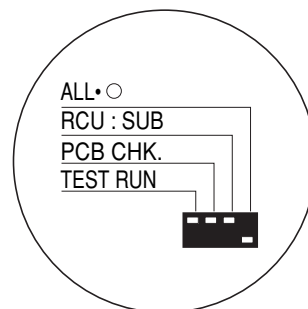
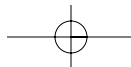

Fig. 7-22

- (3) Make a test run using the air conditioner in COOL or HEAT mode.
- (4) During the test run, the "OPER.," "TIMER," and "STDBY" LED all blink.
 - To protect the air conditioner from overloading, the outdoor unit will not start running for approximately 3 minutes after power is applied or the air conditioner is turned off and then back on.
 - When the DIP switch is set to "TEST – ON," temperature control from the wireless remote controller is disabled. Do not use this setting at any time other than for the test run. Doing so will place an excessive load on the system.
- (5) After the test run, press the ON/OFF operation button on the wireless remote controller. Then, set the TEST RUN switch back to the OFF position to cancel the test run mode.
(This receiver includes a 60-minute automatic OFF timer function in order to prevent continuous test run.)



7-15. Misoperation Alarm Indicators

A blinking lamp for other than the signal receiving unit filter shows that a problem has occurred in the unit, so make an inspection. (Refer to servicing information in the service manual, etc.) Also, if wired remote controller and dedicated service check lines (854-9-9536-044-97: service use) are available, then detailed error information can be obtained by connecting to the service connector as shown in the drawing. For information on how to connect to the signal receiving unit, refer to the instruction manual that came with the dedicated service check lines.

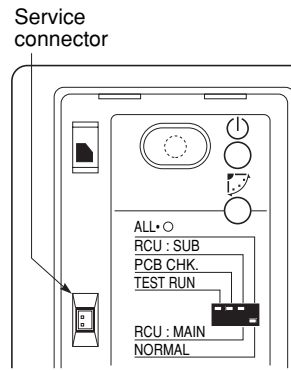

Fig. 7-23

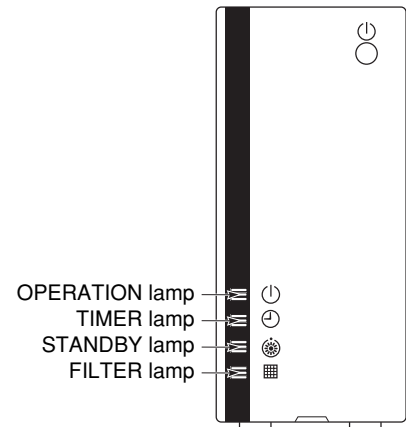

Fig. 7-24

Table 7-2

Lamp			Bright	Cause of Trouble
OPERATION lamp	TIMER lamp	STANDBY lamp		
●	●	●		No power supply or mis-wiring of signal receiving unit.
☼	●	●		S.C.* errors between the indoor unit's controller (PCB) and signal receiving unit.
●	●	☼		S.C. errors between indoor and outdoor units.
●	☼	☼	Alternately	Indoor unit protector is activated.
☼	●	☼	Alternately	Outdoor unit protector is activated.
●	☼	●		Compressor protector is activated.
☼	●	☼	Concurrent	Mis-setting of indoor unit.
☼	☼	☼	Concurrent	Mis-setting of outdoor unit.

* S.C.: Serial communications



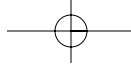

7-16. Basic Wiring Diagram



CAUTION

Be sure to do the wiring correctly (incorrect wiring will damage the equipment).

- Use shielded wires for inter-unit control wiring and ground the shield on both sides. (Fig. 7-25) Otherwise misoperation because of electrical noise may occur.

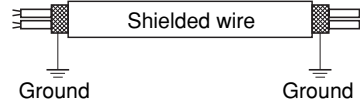
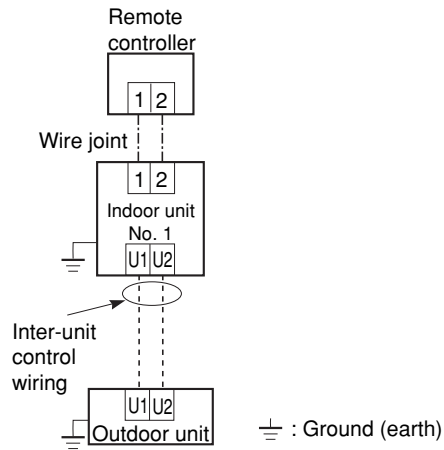
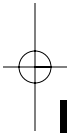

Fig. 7-25

● Wiring procedure

Carry out the wiring according to the above wiring diagram.

- Address setting is automatically executed after turning on the system.
An indoor unit address is assigned to each indoor unit.
- Operation takes place successively at intervals of 1 second, by using combinations of the address setting of each unit.



**RC
(WL)**

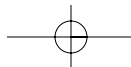

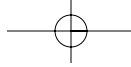

7-17. Wiring System Diagram for Group Control

This diagram shows when several units (maximum of 8) are controlled by a signal receiving unit (main unit). In this case, a signal receiving unit can be connected at any indoor unit.

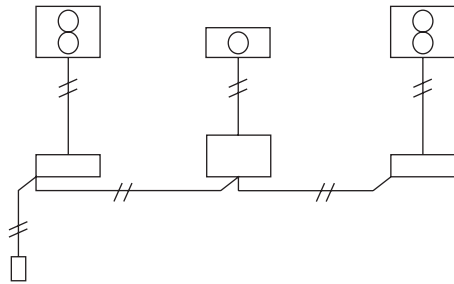

Wiring procedure

Wire according to the diagram at left:

- Address setting is executed automatically when the outdoor unit is turned on.
- Each successive unit will respond at one-second intervals following the order of the group address when the remote controller is operated.

● Group control using 2 signal receiving units

It does not matter which of the 2 signal receiving units you set as the main controller.

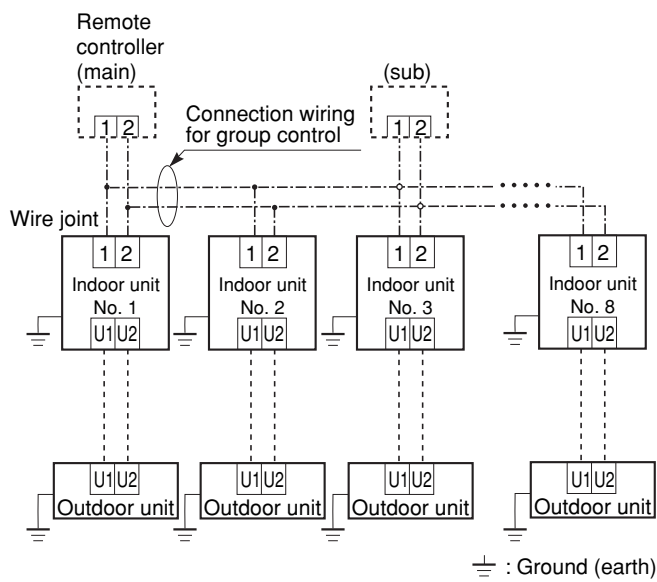

When using multiple signal receiving units (up to 2 can be used), one is the main signal receiving unit and the other is the sub-signal receiving unit.

- To set up a sub-signal receiving unit, change its remote control address connector (RCU. ADR) located on its PCB from main to sub position (main: when shipped from factory).

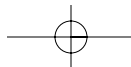

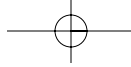

7-18. Wiring System Diagram for Multiple Remote Controllers

- **When installing multiple remote controllers**

This multiple system is used for operating the unit(s) at different positions. (A maximum of 2 signal receiving units can be installed.)

- **Setting method**

To execute this control, make the setting according to the following procedure.

- (1) Of the two installed signal receiving units, make one the main signal receiving unit (factory-shipped state).
- (2) On the other signal receiving unit, change the address connector on the PCB from main to sub position.
In this state, it functions as a sub-signal receiving unit.

- **Basic wiring diagram**



CAUTION

Carry out the wiring correctly (incorrect wiring will damage the equipment).



- To operate 1 indoor unit with 2 signal receiving units set at different locations.

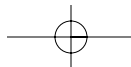
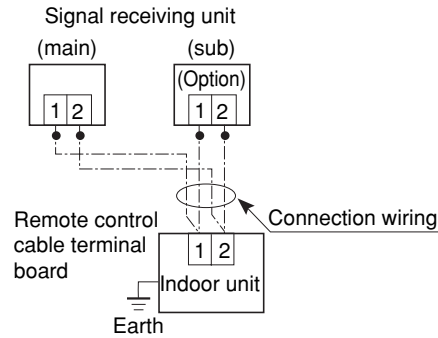

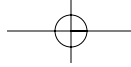

<RCS-SH1UA>

7-19. Test Run Procedure

● Wall-mounted Type
(K Type)

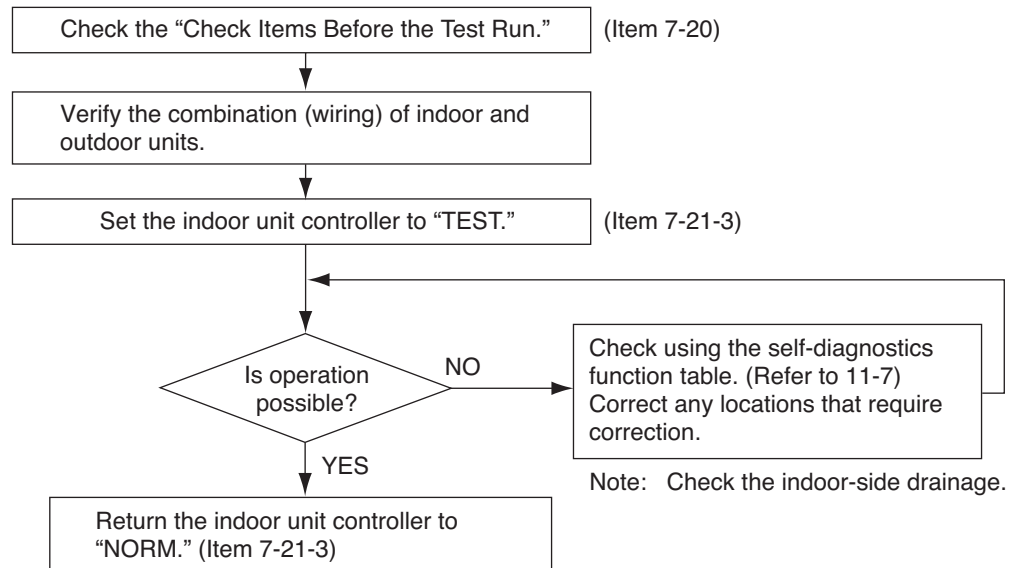

7-20. Check Items Before the Test Run

- (1) Turn ON the remote power switch at least 5 hours before the test run in order to charge the crank-case heater. (If the outdoor unit is an inverter unit, turn ON the power 12 hours in advance.)
- (2) Fully open the service valves on the gas-tube and liquid-tube sides.
- (3) Set the sliding switches on the inside of the wireless remote controller cover to the correct settings for that model. After changing the settings, press the RESET button.

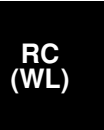

<For 3072R, 3672R>

Verify that sliding switch 1 is in the "K" position.



S: Flap model (4-direction, ceiling suspended)
K: Swing-only model (wall-mounted), settings completed
N: No-flap model (built-in)

<For 2672R>

Verify that sliding switch 1 is in the "S" position.



- Set sliding switch 2 to the correct setting for these models.

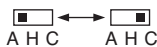

A: Heat pump model
(H: Heat pump, no auto heating/cooling)
C: Cooling-only model

Wireless remote controller transmitter

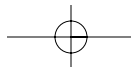
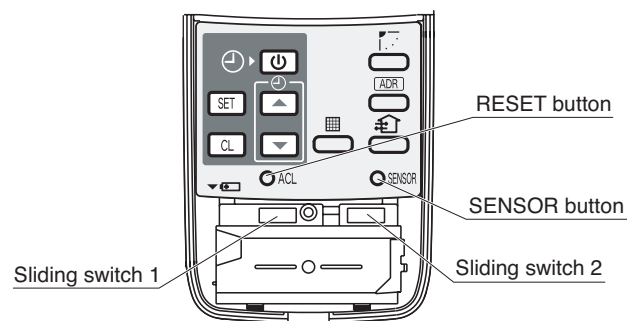

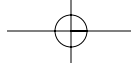

7-21. Preparing for the Test Run

7-21-1. Changing the room temperature sensor

- Room temperature sensors are installed inside the indoor unit and the wireless remote controller. Either room temperature sensor can be used.
- When "Unit Sensor" is indicated on the wireless remote controller LCD, the indoor unit sensor is operating as the room temperature sensor.
To change to the remote controller sensor, open the remote controller cover and press the SENSOR button once. The "Unit Sensor" display disappears, and the remote controller sensor becomes the room temperature sensor.



CAUTION

If the temperature data from the remote controller is not communicated to the indoor unit for a period of 10 minutes when the remote controller sensor is selected, the unit automatically switches back to the indoor unit sensor.
Install the remote controller in a location where the signal can reliably be received by the indoor unit.

7-21-2. Using the remote controller

- Face the remote controller toward the receiver (indoor unit).
- The maximum distance where the remote controller signal can be received is approximately 8 m, however this distance is only a guide. The actual distance may vary somewhat depending on battery capacity and other conditions.
- Make sure there are no obstructions which can block the signal between the remote controller and the receiver.
- When the remote controller signal is received correctly, the indoor unit beeps.
(It beeps twice only when operation is started.)

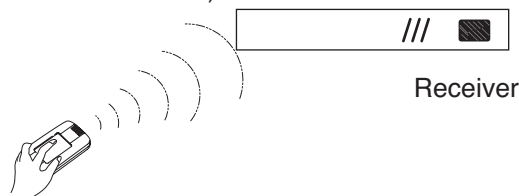

RC
(WL)

- Do not drop, throw, or wash the remote controller.
- Do not place the remote controller in a location exposed to direct sunlight, or near a stove or similar appliance.

7-21-3. Test run

● Using the controller

- (1) Slide the main unit controller switch from "NORM." to "TEST" (for 3072R, 3672R), "ON" to "TEST" (for 2672R).
(The outdoor unit will not operate for approximately 3 minutes after the power is turned ON, or after operation is stopped.)
- (2) All indicator lamps on the display blink while test run is in progress.
- (3) Temperature control is not possible during the test run.
- (4) If normal operation is not possible, the lamps on the display will indicate the problem.
Refer to the self-diagnostics function table and correct the problem.
(See 11-7. Table of Self-Diagnostics and corrections.)
- (5) After the test run is completed, move the controller switch from "TEST" to "NORM." (for 3072R, 3672R), "TEST" to "ON" (for 2672R) and verify that the indicator lamps stop blinking.
(A 60-minute automatic OFF timer function is included in order to prevent continuous test run.)

For 3072R, 3672R

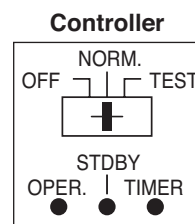

For 2672R

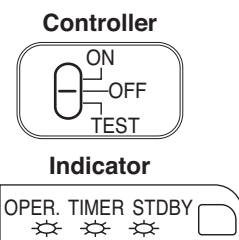

CAUTION

- Do not use this setting at any time other than for the test run. Doing so will place an excessive load on the system.
- Test run is not possible if the power was turned ON when the controller switch was in the "TEST" position. Leave the power ON and move the switch to "NORM." or "OFF," then move the switch back to "TEST."

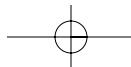

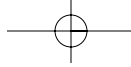

7-22. Precautions

- Request that the customer be present at the time the test run is performed. Explain the Operation Manual to the customer, and then have the customer actually operate the system.
- Be sure to pass the manual and warranty certificate to the customer.
- Verify that the AC 208 / 230 V wiring is not connected to the terminal plate which is used to connect the inter-unit control wiring.

* If AC 208 / 230 V is accidentally applied to this terminal plate, the fuse (0.5A for both indoor and outdoor units) on the inter-unit control PCB will be tripped in order to protect the PCB. Correct the wiring connections, then disconnect the 2P connectors (indoor unit: blue, OC, CN40; outdoor unit: blue, OC) which are connected to the PCB and connect the other 2P connectors (indoor unit: brown, EMG, CN44; outdoor unit: brown, EMG). (See the figure below.)

If operation is still not possible with the brown connectors connected, cut the varistor (black) (for both the indoor and outdoor units).

(Be sure to turn OFF the power before performing this work.)

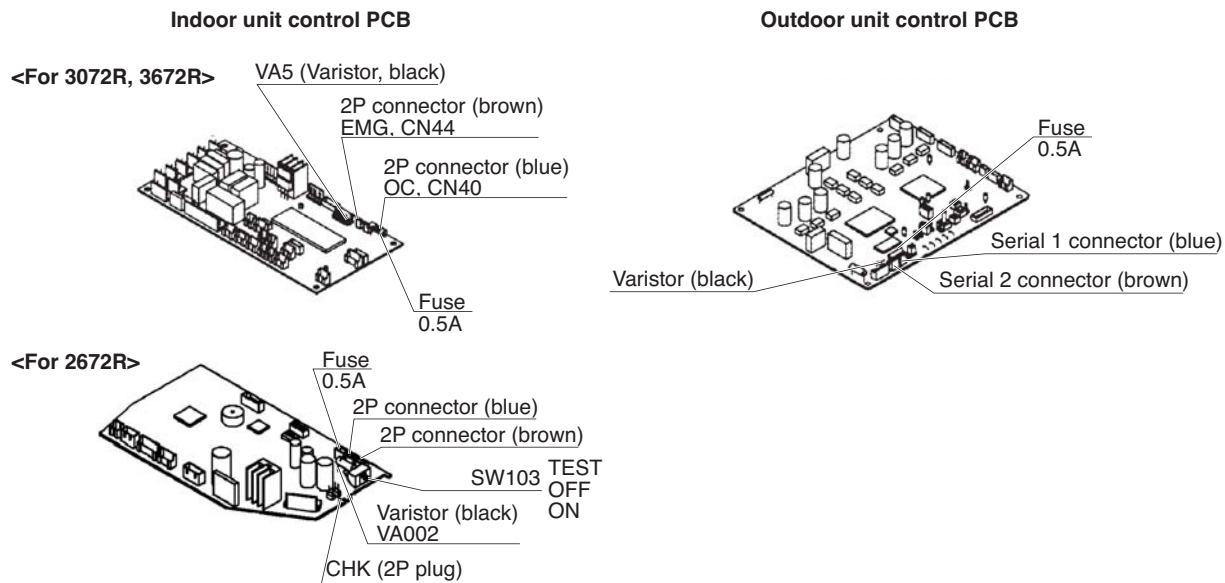

RC
(WL)

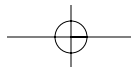

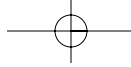

7-23. When Setting Indoor Unit Control PCB Switch for Wall-Mounted Indoor Unit

When using either the wired or wireless remote controller, refer to the tables below and accordingly slide the switch on the indoor unit control PCB.

- If this setting is not made correctly an alarm will occur. (The operation lamp on the display blinks.)
- This setting is not necessary if both the wired remote controller and wireless remote controller are used. However, when you use indoor unit KHS type, set the wired remote controller address connector on the PCB from main to sub position.
- The slide switch setting at the time of factory shipment for model KH type is "A", and for model KHS type is "B."

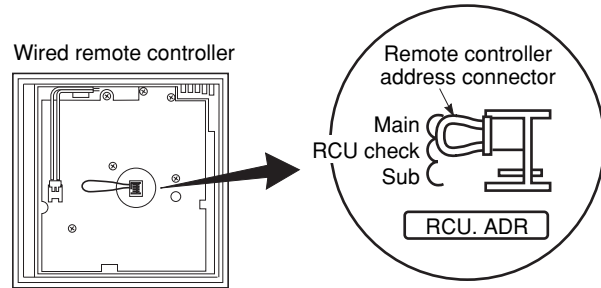

• KH(S)3072 / 3672R, KHH(S)2672R

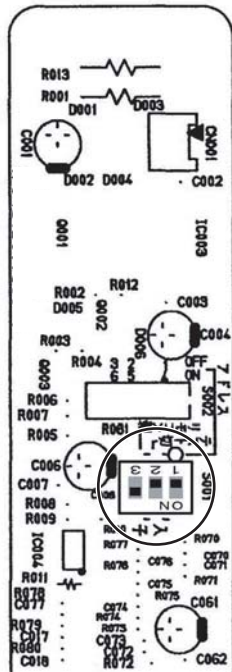

<p>A</p> <p>When using wired remote controller</p>	<p>Nos. 1, 2 OFF, No. 3 ON</p>
<p>B</p> <p>When using wireless remote controller</p>	<p>Nos. 1, 2, 3 all OFF</p>

RC (WL)

• KH(S)2672R

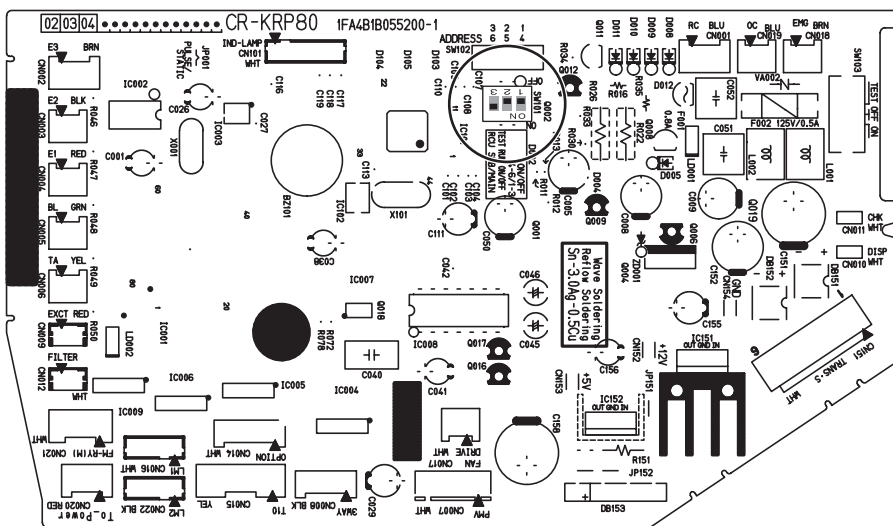

<p>A</p> <p>When using wired remote controller</p>	<p>Nos. 1, 2 OFF, No. 3 ON.</p>
<p>B</p> <p>When using wireless remote controller</p>	<p>Nos. 1, 2, 3 all OFF</p>

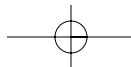

8. HOW TO INSTALL THE SYSTEM CONTROLLER (OPTIONAL PART)



WARNING

Do not supply power to the unit or try to operate it until the tubing and wiring to the outdoor unit are completed.

8-1. System Controller Installation



CAUTION

- Do not twist the control wiring with the power wiring or run it in the same metal conduit, because this may cause malfunction.
- Install the system controller away from sources of electrical noise.
- Install a noise filter or take other appropriate action if electrical noise affects the power supply circuit of the unit.

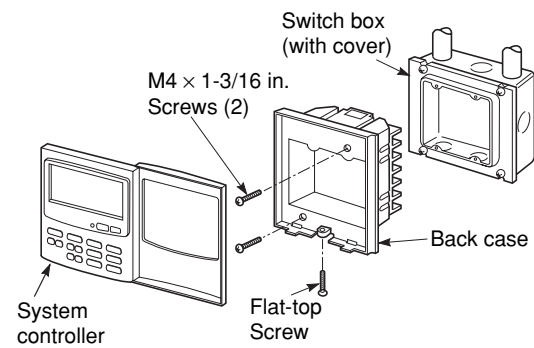

Fig. 8-1

- (1) Remove the flat-top screw on the bottom of the back case. When you open up the decorative cover, you will see two gaps under the system controller. Insert a coin into these gaps and remove the back case. (Figs. 8-1, 8-2)
- (2) Connect the wires to terminal base of the system controller (see next page).
- (3) Attach the back case with the 2 M4 screws provided.
- (4) To finish, fit the back tabs of the back case into the system controller and mount it using the flat-top screw.

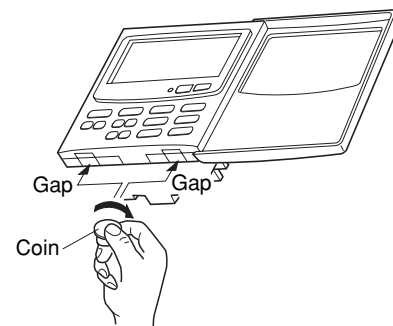

Fig. 8-2

SC

8-2. Electrical Wiring

How to connect electrical wiring

- (1) Connect B1, B2 to indoor PCB CRV connector using accessory 2P connector. (*No polarity)
Total wire length is less than 985 ft. and size is AWG#18.
- (2) Connect B5, B6 to indoor unit 2P terminal base. (*No polarity). Wire size is AWG#18.

● Basic wiring

- B1: Power supply: DC12V *No polarity
- B2: To CRV connector (CN91) on indoor PCB
- B3: Not be used
- B4: Auxiliary of inter-unit control wiring
- B5: Inter-unit control wiring. (Low voltage)
- B6: To indoor unit 2P terminal base (U1, U2)
*No polarity

● Terminals for remote monitoring

- A1: Input for turning on air conditioners concurrently.
- A2: Input for turning off air conditioners concurrently.
- A3: Common input for turning air conditioners on or off.
- A4: ON operation state indicator output.
- A5: Alarm indicator output.
- A6: Common indicator output.

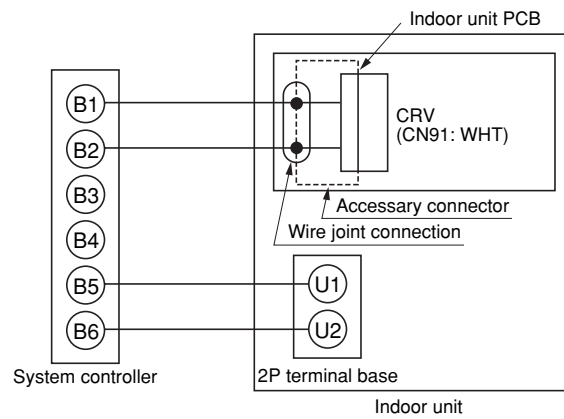

Fig. 8-3

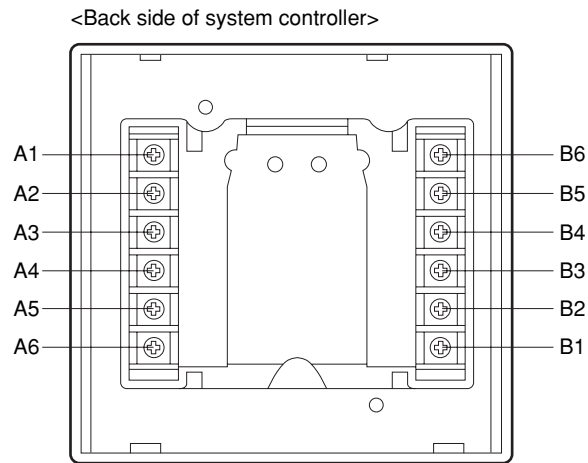
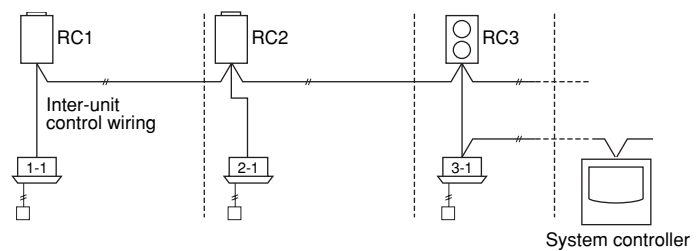

Fig. 8-4

SC

Basic wiring diagram of control wiring

- A max. of 64 indoor units and 30 outdoor units can be connected in 1 system.
- Up to 10 system controllers can be connected in 1 system.



8-3. Address Switch Setting

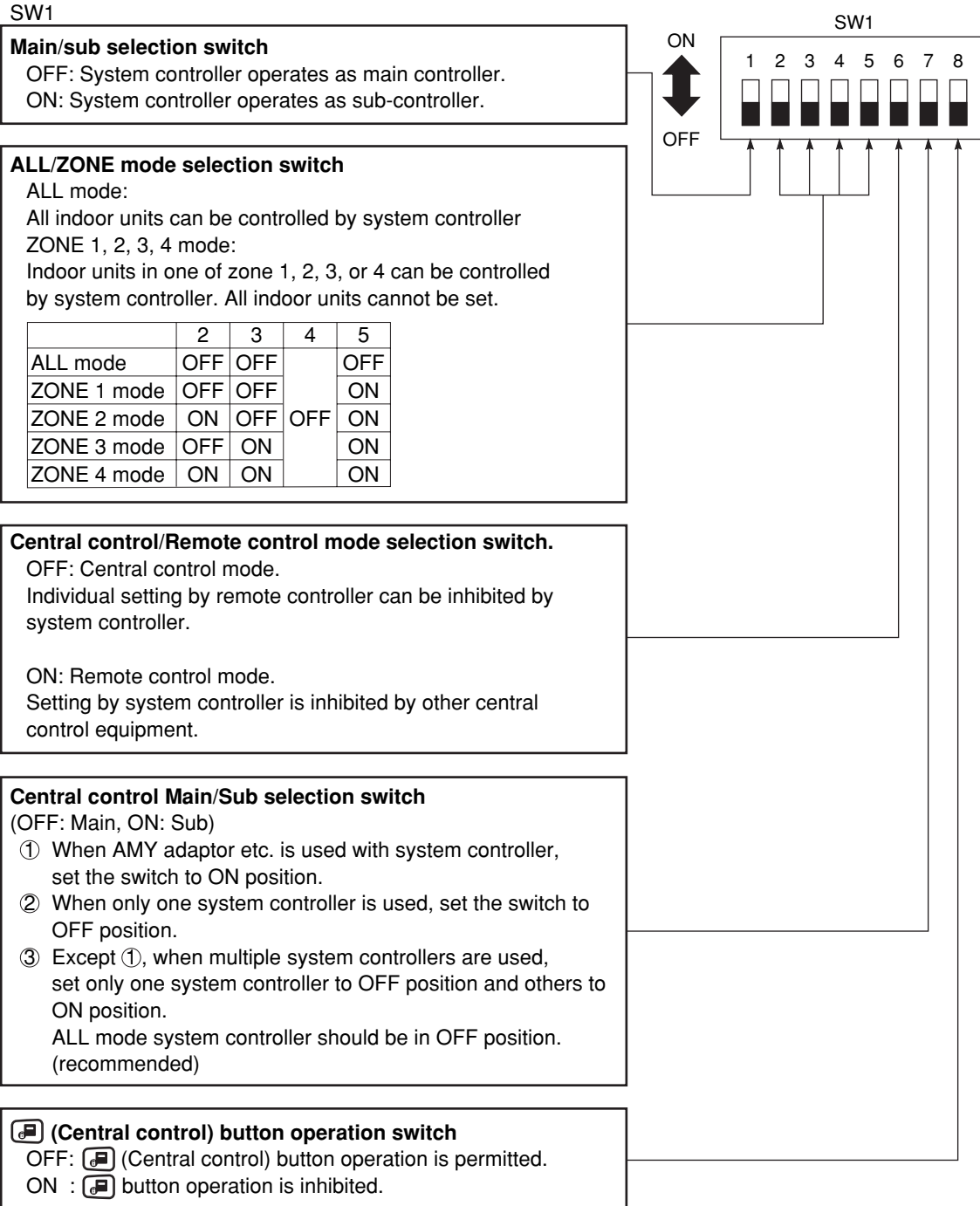

*All switches are in OFF position at shipment.



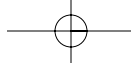

SW2

Weekly timer input switches

System controller operation can be set when weekly timer activates (ON/OFF).

System controller operation	Switch No.		
	1	2	3
① Timer OFF→ON	All ON	All OFF	All OFF
② No change	All OFF	All OFF	All OFF
③ Individual control of all indoor units to be permitted	All indoor units to be 1*1	OFF	ON
④ Same as above	All OFF and all indoor units to be 1*1	ON	ON
⑤ Same as above	All indoor units to be 2*2	OFF	OFF
⑥ Same as above	All OFF and all indoor units to be 2*2	ON	OFF

In case of Remote control mode, use ① or ②.

In case of ZONE 1, 2, 3, 4 mode, ALL, all indoor units means one of ZONE 1, 2, 3, 4.

*1: 1 (Central control 1) means ON/OFF operation cannot be executed by remote controller.

*2: 2 (Central control 2) means ON/OFF, MODE change. Temp. setting cannot be executed by remote controller.

Auxiliary switch

Must be set to OFF position.

Beep tone switch

OFF: Beep tone when each button is pushed.
ON: No tone when each button is pushed.

Indication switch

Normally set to OFF position.
When set to ON position, indication is not displayed on LCD of system controller.

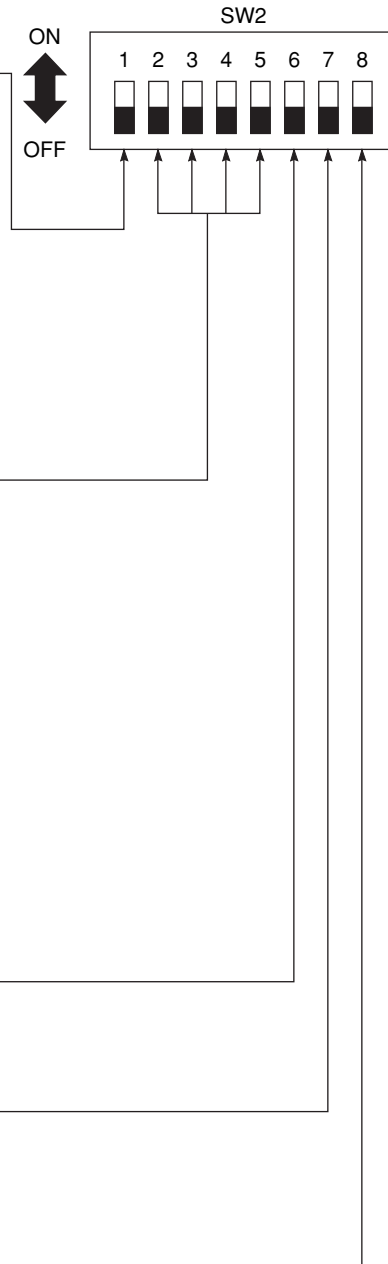

SC

*All switches are in OFF position at shipment.

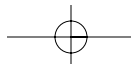

8-4. Mode Setting

According to the function of each system controller, set SW1 as shown in Fig. 8-5.

(1) Central control/Remote control mode

● **Central control mode**

The system controller is used as the central control equipment.

Individual setting by remote controller can be inhibited by the system controller

● **Remote control mode**

The system controller is used as the remote controller.

Setting by system controller is inhibited by other central control equipment.

(2) ALL/ZONE mode

● **ALL mode**

All indoor units can be controlled by the system controller.

● **ZONE mode**

Indoor units in one of ZONE 1, 2, 3 or 4 can be controlled by the system controller

(3) The function of the system controller consists of 10 types according to the combination of central control/remote control mode and ALL/ZONE mode setting as shown in the table 8-1.

(4) Stick the system controller unit label in a conspicuous position.

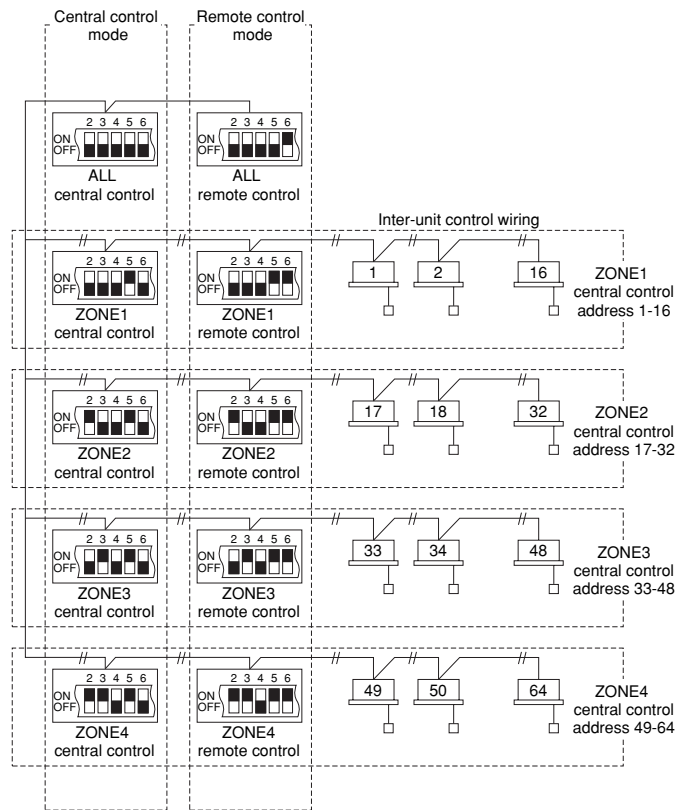
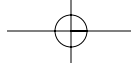

Fig. 8-5

Table 8-1

	Central control	Remote control
ALL	1. ALL/Central	6. ALL/Remote
ZONE1	2. ZONE1/Central	7. ZONE1/Remote
ZONE2	3. ZONE2/Central	8. ZONE2/Remote
ZONE3	4. ZONE3/Central	9. ZONE3/Remote
ZONE4	5. ZONE4/Central	10. ZONE4/Remote

SC



8-5. How to Perform Zone Registration

To operate the system controller properly, zone registration is required after finishing the test run (and after setting all indoor unit addresses) using one of the following methods.

- (a) Zone registration using the remote controller (RCS-SH80UG)
Refer to page 91.
- (b) Zone registration using the system controller (SHA-KC64UG)
Refer to page 92.
- (c) Automatic zone registration using the system controller (SHA-KC64UG)
Refer to page 93.

For methods (a) and (b), you should make a zone registration table manually before performing the registration as shown on the next page.

For method (c), zone registration is executed automatically, proceeding from the smallest indoor unit address and smallest central addresses to larger numbers in numerical order. For example:

Central address	1	2	3	4	5	6
ZONE-group	1-1	1-2	1-3	1-4	1-5	1-6
Indoor unit address	1-1	1-2	2-1	2-2	2-3	3-1

NOTE

1. An indoor unit address is assigned to each indoor unit during automatic address operation. Each indoor unit address combines an R.C. address and indoor unit number as follows:

1 - 1 : Indoor unit address (UNIT No.)
 ↑ Indoor unit No.
 ↑ Refrigerant circuit No. (R.C. address)

2. This address is displayed on the remote controller for UNIT No. when the UNIT button is pressed.

The central address represents the zone and group number. These addresses are assigned in ascending numerical order.

SC

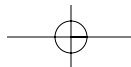





(a) Zone registration using the remote controller (RCS-SH80UG)

(Determination of central address)

- In this case, after confirming which indoor unit is connected to the remote controller and that the air conditioner in the OFF state, you set the central addresses one at a time.
- If the system has no remote controller, connect a remote controller to the system temporarily. Then follow this procedure.



NOTE

The indoor unit address must already have been set before performing zone registration. If necessary, refer to the Installation Manual supplied with the outdoor unit.

- (1) Press the  and  buttons on the remote controller at the same time for more than 4 seconds.
- (2) Do not press  button.
- (3) Once in this mode, the UNIT No., CODE No., No. of SET DATA and  indications will flash on the display as shown Fig. 8-6.







NOTE

In case of group control "ALL" instead of "UNIT No." will flash on the display. Select the main indoor unit address by pressing the  button once.

- (4) Set CODE No. to 03 using the  and  () buttons.

NOTE

CODE No. 03 must be selected to perform zone registration using the remote controller.

- (5) Set the Central address you want to assign to the indoor unit address using the  and  () buttons according to the zone registration table.
- (6) Press the  button. The CODE No. and Central address changes from flashing to ON state. If you make a mistake, press the  button and reset the central address.
- (7) Press the  button to finish zone registration.

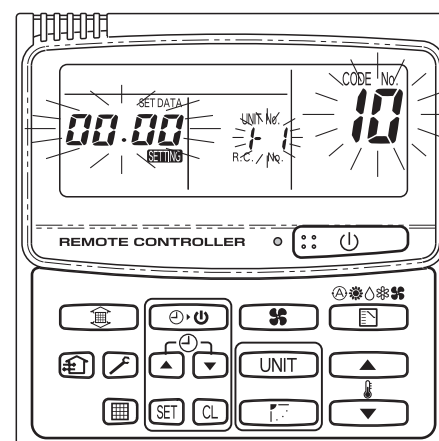
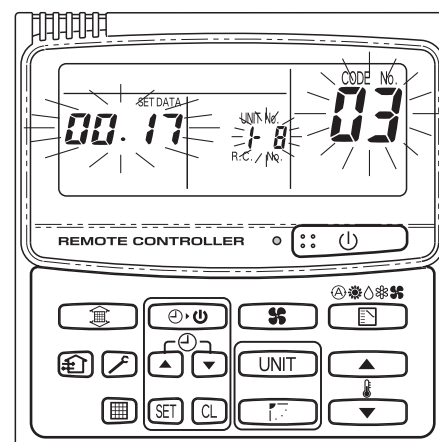

Fig. 8-6



For example, in this case
Indoor unit address: 1-8
Central address : 17 (Zone 2, Group 1)

Fig. 8-7

SC

(b) Zone registration using the system controller (SHA-KC64UG)

- In this case, you set all central addresses by the system controller at once manually.

- (1) Press the and buttons at the same time for more than 4 seconds. and CODE No. C1 will flash.
- (2) After confirming that CODE No. C1 is displayed, press the . Once in this mode, a change takes place as shown in Fig. 8-8.
- (3) Select the zone and group No. you want to set with and (GROUP) buttons.
If already set, press the buttons.
- (4) Set the unit No. (indoor unit address) with and buttons, according to the zone registration table.
R.C. No. button
Indoor unit No. button
- (5) Press the .
GROUP No. turns ON and UNIT No. (indoor unit address) changes from flashing to ON state.
UNIT No. is registered to the selected ZONE No. and GROUP No.
If you make a mistake, press the button and reselect the ZONE, GROUP and UNIT No.
- (6) Register the other UNIT Nos. in the same way by following steps (3) to (5).
- (7) Finally, complete the registration by pressing the button.
 flashes for a few minutes, then turns OFF.

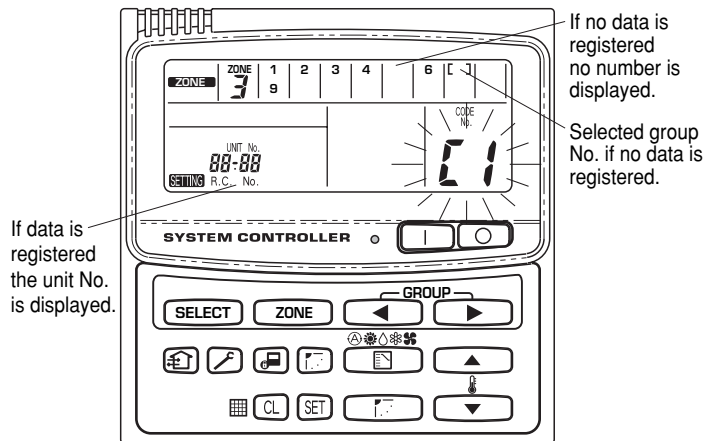
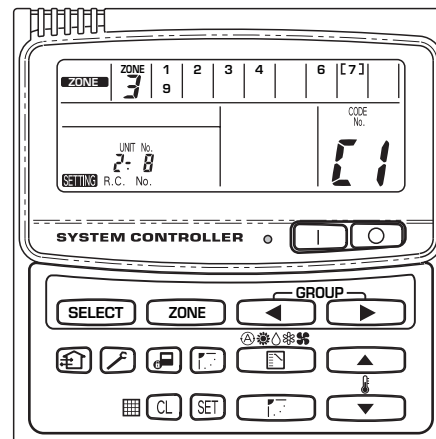

Fig. 8-8







For example, in this case
Zone 3, Group No. 7
Unit No. (indoor unit address) 2-8
Unit No. 2-8 is registered to Zone 3, Group 7.

Fig. 8-9

SC

(c) **Automatic zone registration using the system controller (SHA-KC64UG)**

- (1) Press the  and **ZONE** buttons at the same time for more than 4 seconds.
SETTING and CODE No. C1 will flash.
- (2) Select CODE No. C2 by pressing  and  button and press the **SET** button.
C2 changes from flashing to ON state and automatic zone registration will start.
- (3) Any registered GROUP Nos. will be erased.
- (4) Central address will be assigned from the smallest indoor unit address to larger ones in numerical order automatically.
On finishing automatic zone registration, **SETTING** changes from flashing to OFF.
- (5) If an error occurs, "CHECK" starts flashing and zone registration finishes at this time. Press the **CL** button to start over.
- (6) Finally, complete automatic zone registration mode by pressing the  button.
SETTING flashes for a few minutes, then turns OFF.

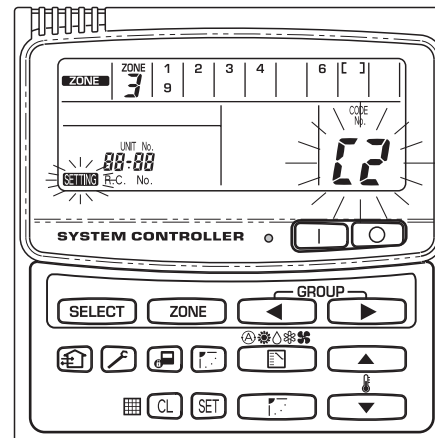









Fig. 8-10

■ How to check for overlapping of central address Nos.

- (1) Press the  and **ZONE** buttons at the same time for more than 4 seconds.
SETTING and CODE No. C1 will flash.
- (2) Select CODE No. C3 by pressing ,  (Ⓜ) button and press the **SET** button.
C3 changes from flashing to ON state and **SETTING** will flash. Then auto overlap checking will start.
- (3) If C3 changes from ON to flashing and **SETTING** stops flashing and disappears, there is no overlapping.
Then finally, complete the auto overlap checking mode by pressing the  button.
- (4) If some of GROUP No., ZONE No. and UNIT No. flash, you should try the zone registration again.
 - ① Select CODE No. C1 by pressing ,  (Ⓜ) button and press the **SET** button.
 - ② Select the flashing GROUP No. with the **ZONE** and **GROUP** buttons.
Then press the **CL** button and reselect the ZONE, GROUP and UNIT No.
 - ③ Then finally, complete the auto overlap checking mode by pressing the  button.

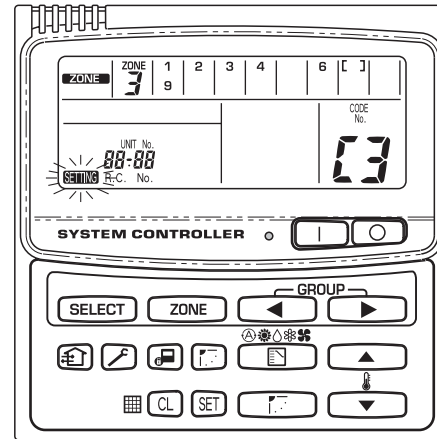
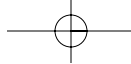

Fig. 8-11



■ ZONE registration table

ZONE	GROUP	Central address	Indoor unit address (UNIT No.)	Unit location	ZONE	GROUP	Central address	Indoor unit address (UNIT No.)	Unit location
1	1	1			3	1	33		
	2	2				2	34		
	3	3				3	35		
	4	4				4	36		
	5	5				5	37		
	6	6				6	38		
	7	7				7	39		
	8	8				8	40		
	9	9				9	41		
	10	10				10	42		
	11	11				11	43		
	12	12				12	44		
	13	13				13	45		
	14	14				14	46		
	15	15				15	47		
	16	16				16	48		
2	1	17			4	1	49		
	2	18				2	50		
	3	19				3	51		
	4	20				4	52		
	5	21				5	53		
	6	22				6	54		
	7	23				7	55		
	8	24				8	56		
	9	25				9	57		
	10	26				10	58		
	11	27				11	59		
	12	28				12	60		
	13	29				13	61		
	14	30				14	62		
	15	31				15	63		
	16	32				16	64		

- NOTE**
1. Assign indoor unit addresses to the desired positions (central addresses) manually.
 2. For group control, only the main indoor unit should be assigned. Sub indoor units cannot be assigned.

SC

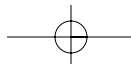

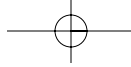

8-6. Connection with Other Equipment

Name Input/output item	System controller		Equipment		
	Input/output	Terminal	Terminal	Example	Input/output
Digital input/output terminals	ON/OFF output Alarm output Potential free A contact, static (relay output) Contact capacity DC 30V, 0.5A		CPEV AWG#16		Wire length: less than 330 ft.
	All ON input All OFF input Pulse (photo coupler input) Contact capacity DC 24V, 10mA		CPEV AWG#16		Pulse width: more than 984 ft./sec. Wire length: less than 330 ft.

8-7. Memory Backup Switch

Check the backup switch is ON on the for back side of the PCB of the system controller.

8-8. Test Run

- (1) Power on all indoor units. Next, power on the system controller. **SETTING** will flash, checking the indoor unit addresses automatically.
- (2) If group No. displayed on system controller is not the same as the indoor unit No.* which is connected, see Fig. 9-5 and carry out setting again.

*In case of group control, main unit No. only.

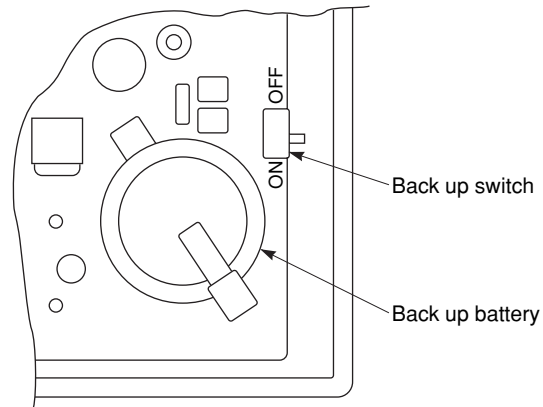

SC

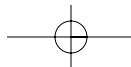

9. HOW TO PROCESS TUBING

The liquid tubing side is connected by a flare nut, and the gas tubing side is connected by brazing.

9-1. Connecting the Refrigerant Tubing

Use of the Flaring Method

Many conventional split system air conditioners employ the flaring method to connect refrigerant tubes which run between indoor and outdoor units. In this method, the copper tubes are flared at each end and connected with flare nuts.

Flaring Procedure with a Flare Tool

- (1) Cut the copper tube to the required length with a tube cutter. It is recommended to cut approx. 12 – 20 in. longer than the tubing length you estimate.
- (2) Remove burrs at each end of the copper tubing with a tube reamer or file. This process is important and should be done carefully to make a good flare. Be sure to keep any contaminants (moisture, dirt, metal filings, etc.) from entering the tubing. (Figs. 9-1 and 9-2)

NOTE

When reaming, hold the tube end downward and be sure that no copper scraps fall into the tube. (Fig. 9-2)

- (3) Remove the flare nut from the unit and be sure to mount it on the copper tube.
- (4) Make a flare at the end of the copper tube with a flare tool.* (Fig. 9-3)

*Use "RIGID®" or equivalent.

NOTE

A good flare should have the following characteristics:

- inside surface is glossy and smooth
- edge is smooth
- tapered sides are of uniform length

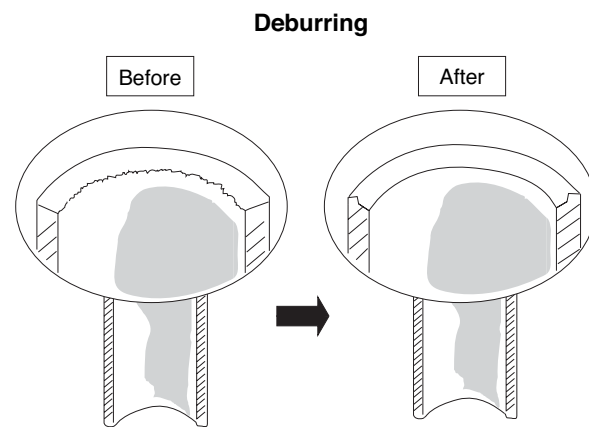

Fig. 9-1

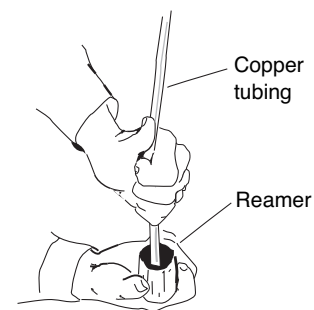

Fig. 9-2

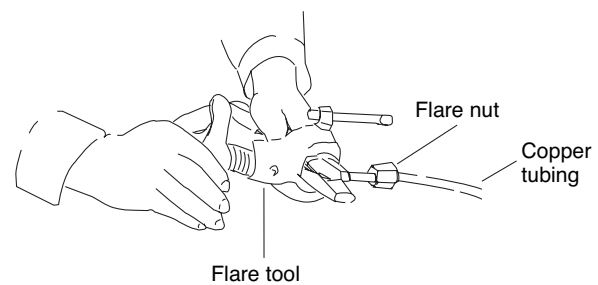
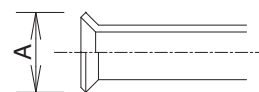
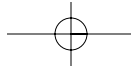

Fig. 9-3



Flare size: A (inch)

Copper tubing (Outer dia.)	A $\begin{matrix} 0 \\ -0.4 \end{matrix}$
ø1/4	23/64
ø3/8	33/64
ø1/2	21/32
ø5/8	25/32



Caution Before Connecting Tubes Tightly

- (1) Apply a sealing cap or water-proof tape to prevent dust or water from entering the tubes before they are used.
 - (2) Be sure to apply refrigerant lubricant to the matching surfaces of the flare and union before connecting them together. This is effective for reducing gas leaks. (Fig. 9-4)
 - (3) For proper connection, align the union tube and flare tube straight with each other, then screw on the flare nut lightly at first to obtain a smooth match. (Fig. 9-5)
- Adjust the shape of the liquid tube using a tube bender at the installation site and connect it to the liquid tubing side valve using a flare.

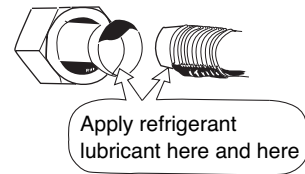

Fig. 9-4

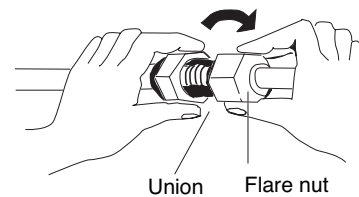

Fig. 9-5

Cautions During Brazing

- **Replace air inside the tube with nitrogen gas to prevent copper oxide film from forming during the brazing process. (Oxygen, carbon dioxide and Freon are not acceptable.)**
- **Do not allow the tubing to get too hot during brazing. The nitrogen gas inside the tubing may overheat, causing refrigerant system valves to become damaged. Therefore allow the tubing to cool when brazing.**
- **Use a reducing valve for the nitrogen cylinder.**
- **Do not use agents intended to prevent the formation of oxide film. These agents adversely affect the refrigerant and refrigerant oil, and may cause damage or malfunctions.**

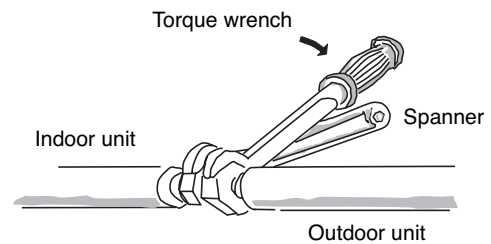

Fig. 9-6

9-2. Connecting Tubing between Indoor and Outdoor Units

- (1) Tightly connect the indoor-side refrigerant tubing extended from the wall with the outdoor-side tubing.
- (2) To fasten the flare nuts, apply specified torque as at right.

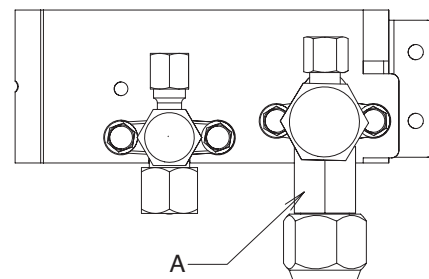

Fig. 9-7

- When removing the flare nuts from the tubing connections, or when tightening them after connecting the tubing, be sure to use 2 monkey wrenches or spanners as shown. (Fig. 9-6) If the flare nuts are over-tightened, the flare may be damaged, which could result in refrigerant leakage and cause injury or asphyxiation to room occupants.
- When removing or tightening the gas tube flare nut, use 2 monkey wrenches together: one at the gas tube flare nut, and one at part A. (Fig. 9-7)
- For the flare nuts at tubing connections, be sure to use the flare nuts that were supplied with the unit, or else flare nuts for R410A (type 2). The refrigerant tubing that is used must be of the correct wall thickness as shown in the table at right.

Tube diameter	Tightening torque (approximate)	Tube thickness
ø1/4" (6.35 mm)	14 – 18 N · m (140 – 180 kgf · cm)	1/32 in.
ø3/8" (9.52 mm)	34 – 42 N · m (340 – 420 kgf · cm)	1/32 in.
ø1/2" (12.7 mm)	49 – 61 N · m (490 – 610 kgf · cm)	1/32 in.
ø5/8" (15.88 mm)	68 – 82 N · m (680 – 820 kgf · cm)	1/32 in.

Because the pressure is approximately 1.6 times higher than conventional refrigerant pressure, the use of ordinary flare nuts (type 1) or thin-walled tubes may result in tube rupture, injury, or asphyxiation caused by refrigerant leakage.

- In order to prevent damage to the flare caused by over-tightening of the flare nuts, use the table above as a guide when tightening.
- When tightening the flare nut on the liquid tube, use a monkey wrench with a nominal handle length of 7-7/8 in.

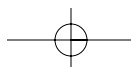

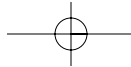

- Do not use a spanner to tighten the valve stem caps. Doing so may damage the valves.
- Depending on the installation conditions, applying excessive torque may cause the nuts to crack.

Precautions for Packed Valve Operation

- If the packed valve is left for a long time with the valve stem cap removed, refrigerant will leak from the valve. Therefore, do not leave the valve stem cap removed.
- Use a torque wrench to securely tighten the valve stem cap.
- Valve stem cap tightening torque:

Charging port	8 – 10 N • m (80 – 100 kgf • cm)
ø3/8" (Liquid side)	19 – 21 N • m (190 – 210 kgf • cm)
ø5/8" (Gas side)	28 – 32 N • m (280 – 320 kgf • cm)

9-3. Insulating the Refrigerant Tubing

Tubing Insulation

- Thermal insulation must be applied to all unit tubing, including the distribution joint (purchased separately).
 - * For gas tubing, the insulation material must be heat resistant to 248°F or above. For other tubing, it must be heat resistant to 176°F or above.
- Insulation material thickness must be 13/32 in. or greater. If the conditions inside the ceiling exceed DB 86°F and RH 70%, increase the thickness of the gas tubing insulation material by 1 step.



CAUTION

If the exterior of the outdoor unit valves has been finished with a square duct covering, make sure you allow sufficient space to access the valves and to allow the panels to be attached and removed.

Taping the flare nuts

Wind the white insulation tape around the flare nuts at the gas tube connections. Then cover up the tubing connections with the flare insulator, and fill the gap at the union with the supplied black insulation tape. Finally, fasten the insulator at both ends with the supplied vinyl clamps. (Fig. 9-10)

Insulation material

The material used for insulation must have good insulation characteristics, be easy to use, be age resistant, and must not easily absorb moisture.



CAUTION

After a tube has been insulated, never try to bend it into a narrow curve because it can cause the tube to break or crack.

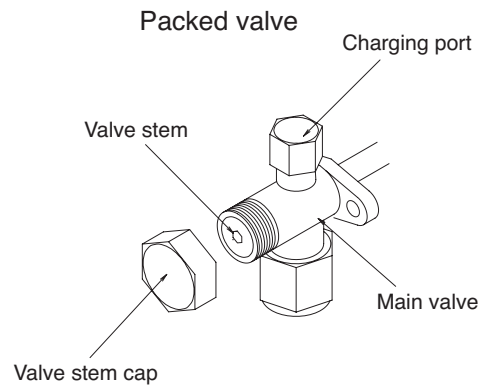

Fig. 9-8

2 tubes arranged together

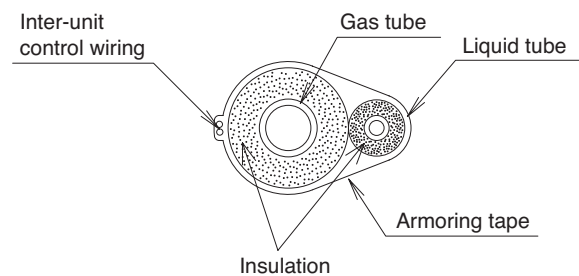

Fig. 9-9

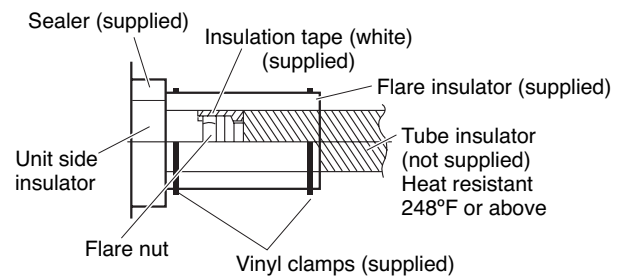

Fig. 9-10

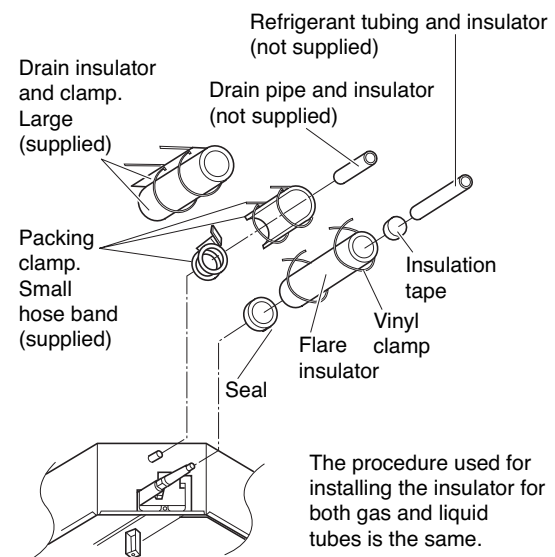
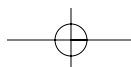

Fig. 9-11

Never grasp the drain or refrigerant connecting outlets when moving the unit.



9-4. Taping the Tubes

- (1) At this time, the refrigerant tubes (and electrical wiring if local codes permit) should be taped together with armoring tape in 1 bundle. To prevent condensation from overflowing the drain pan, keep the drain hose separate from the refrigerant tubing.
- (2) Wrap the armoring tape from the bottom of the outdoor unit to the top of the tubing where it enters the wall. As you wrap the tubing, overlap half of each previous tape turn.
- (3) Clamp the tubing bundle to the wall, using 1 clamp approx. each meter. (Fig. 9-12)

NOTE

Do not wind the armoring tape too tightly since this will decrease the heat insulation effect. Also ensure that the condensation drain hose splits away from the bundle and drips clear of the unit and the tubing.

9-5. Finishing the Installation

After finishing insulating and taping over the tubing, use sealing putty to seal off the hole in the wall to prevent rain and draft from entering. (Fig. 9-13)

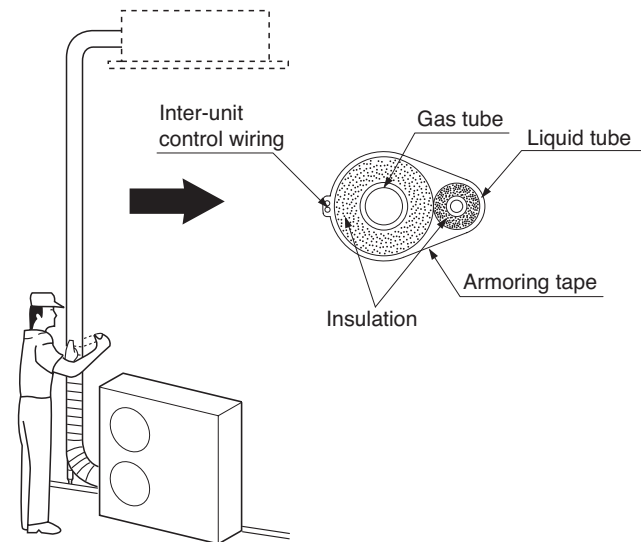

Fig. 9-12

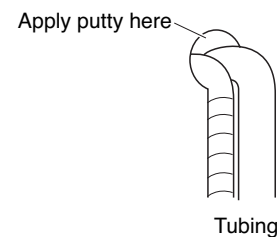

Fig. 9-13

10. LEAK TEST, EVACUATION AND ADDITIONAL REFRIGERANT CHARGE

- Perform an air-tightness test for this package A/C. Check that there is no leakage from any of the connections. Air and moisture in the refrigerant system may have undesirable effects as indicated below.
- pressure in the system rises
- operating current rises
- cooling (or heating) efficiency drops
- moisture in the refrigerant circuit may freeze and block capillary tubing
- water may lead to corrosion of parts in the refrigerant system

Therefore, the indoor unit and tubing between the indoor and outdoor unit must be leak tested and evacuated to remove any noncondensables and moisture from the system.

■ Air Purging with a Vacuum Pump (for Test Run) Preparation

Check that each tube (both liquid and gas tubes) between the indoor and outdoor units has been properly connected and all wiring for the test run has been completed. Remove the valve caps from both the gas and liquid service valves on the outdoor unit. Note that both liquid and gas tube service valves on the outdoor unit are kept closed at this stage.

- The refrigerant charge at the time of shipment is only guaranteed sufficient for a tubing length of up to 100 ft. The tubing may exceed this length, up to the maximum permitted length; however, an additional charge is necessary for the amount that the tubing exceeds 100 ft. (No additional refrigerating machine oil is needed.)

10-1. Leak Test

- (1) With the service valves on the outdoor unit closed, remove the 1/4 in. flare nut and its bonnet on the gas tube service valve. (Save for reuse.)
- (2) Attach a manifold valve (with pressure gauges) and dry nitrogen gas cylinder to this service port with charge hoses.



CAUTION

Use a manifold valve for air purging. If it is not available, use a stop valve for this purpose. The "Hi" knob of the manifold valve must always be kept closed.

Manifold gauge

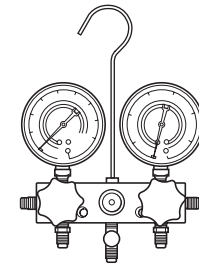

Fig. 10-1

Vacuum pump

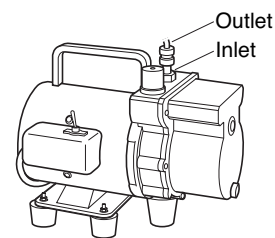

Fig. 10-2

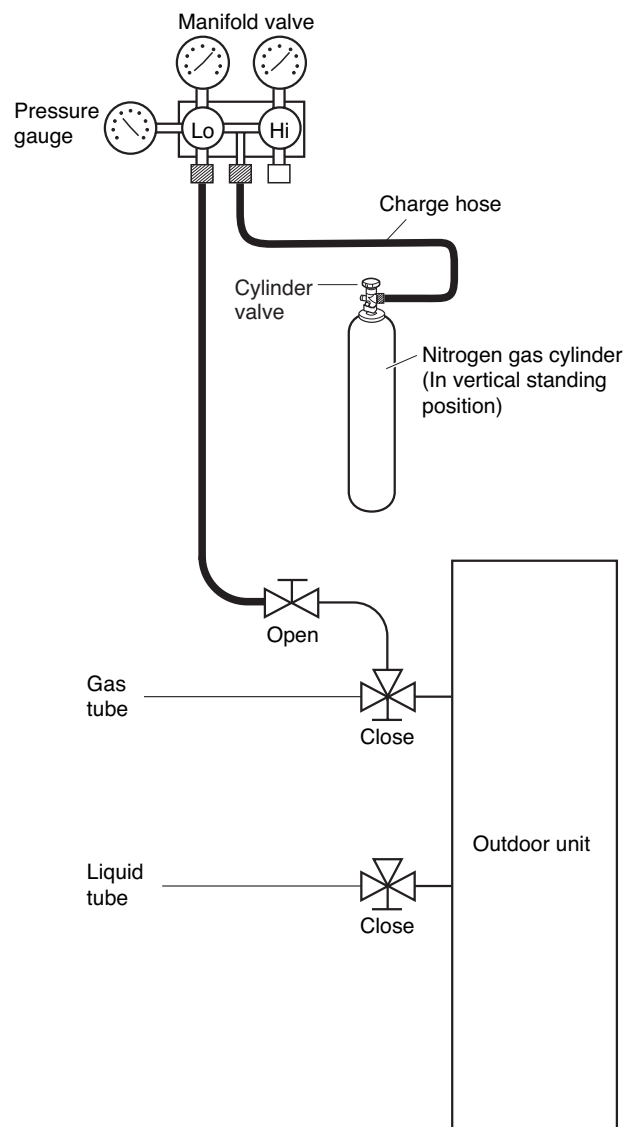

Fig. 10-3

- (3) Pressurize the system up to 4.15 MPa (42 kgf/cm²G) with dry nitrogen gas and close the cylinder valve when the gauge reading reaches 4.15 MPa (42 kgf/cm²G). Then, test for leaks with liquid soap.

**CAUTION**

To avoid nitrogen entering the refrigerant system in a liquid state, the top of the cylinder must be higher than the bottom when you pressurize the system. Usually, the cylinder is used in a vertical standing position.

- (4) Do a leak test of all joints of the tubing (both indoor and outdoor) and both gas and liquid service valves. Bubbles indicate a leak. Wipe off the soap with a clean cloth after the leak test.
- (5) After the system is found to be free of leaks, relieve the nitrogen pressure by loosening the charge hose connector at the nitrogen cylinder. When the system pressure is reduced to normal, disconnect the hose from the cylinder.

C

10-2. Evacuation

Be sure to use a vacuum pump that includes a function for prevention of back-flow, in order to prevent back-flow of pump oil into the unit tubing when the pump is stopped.

- Perform vacuuming of the indoor unit and tubing. Connect the vacuum pump to the gas tube valve and apply vacuum at a pressure of -755 mmHg (5 Torr) or below. Continue vacuum application for a minimum of 1 hour after the pressure reaches -755 mmHg.)

- (1) Attach the charge hose end described in the preceding steps to the vacuum pump to evacuate the tubing and indoor unit. Confirm that the "Lo" knob of the manifold valve is open. Then, run the vacuum pump.
- (2) When the desired vacuum is reached, close the "Lo" knob of the manifold valve and turn off the vacuum pump. Confirm that the gauge pressure is under 667 Pa (-755 mmHg, 5 Torr) after 4 to 5 minutes of vacuum pump operation.

**CAUTION**

Use a cylinder specifically designed for use with R410A.

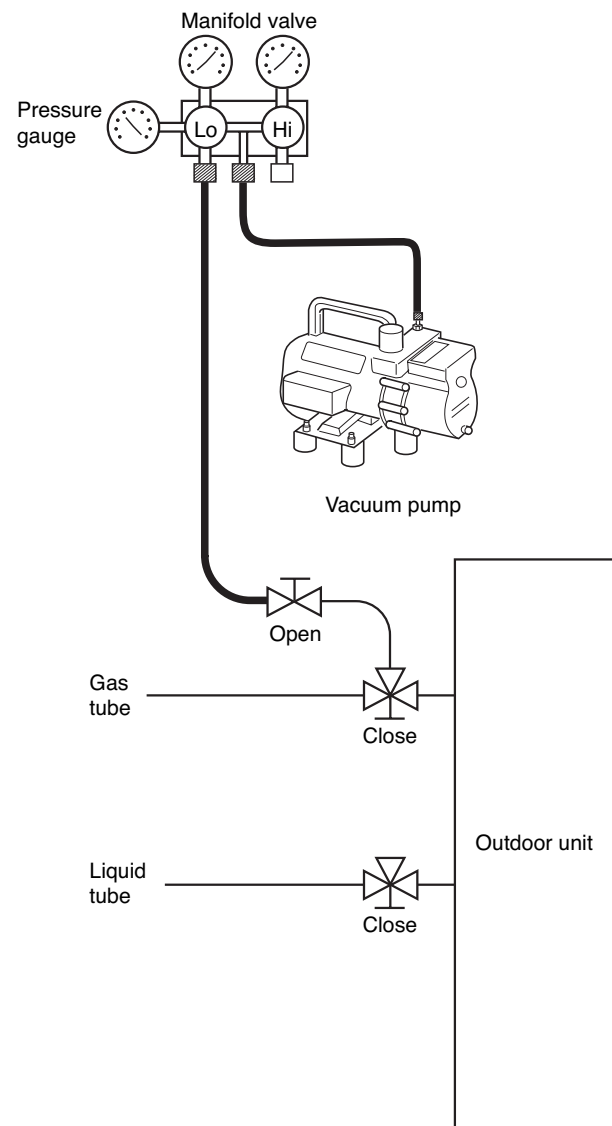

Fig. 10-4

10-3. Charging Additional Refrigerant

- Charging additional refrigerant (calculated from the liquid tube length as shown on page 14, Amount of additional refrigerant charge) using the liquid tube service valve. (Fig. 10-5)
- Use a balance to measure the refrigerant accurately.
- If the additional refrigerant charge amount cannot be charged at once, charge the remaining refrigerant in liquid form by using the gas tube service valve with the system in Cooling mode at the time of test run. (Fig. 10-6)

* If an additional refrigerant charge has been performed, list the refrigerant tubing length and amount of additional refrigerant charge on the product label (inside the panel).

10-4. Finishing the Job

- (1) With a hex wrench, turn the liquid tube service valve stem counter-clockwise to fully open the valve.
- (2) Turn the gas tube service valve stem counter-clockwise to fully open the valve.



CAUTION

To avoid gas from leaking when removing the charge hose, make sure the stem of the gas tube is turned all the way out ("BACK SEAT" position).

- (3) Loosen the charge hose connected to the gas tube service port (5/16 in.) slightly to release the pressure, then remove the hose.
- (4) Replace the 5/16 in. flare nut and its bonnet on the gas tube service port and fasten the flare nut securely with an adjustable wrench or box wrench. This process is very important to prevent gas from leaking from the system.
- (5) Replace the valve caps at both gas and liquid service valves and fasten them securely.

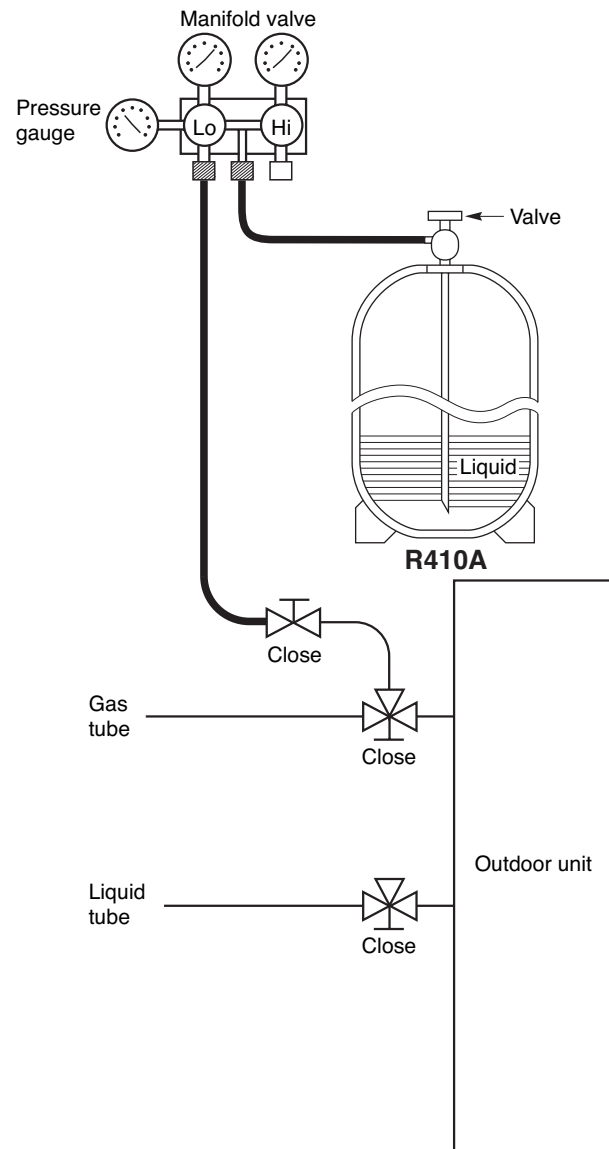

Fig. 10-5

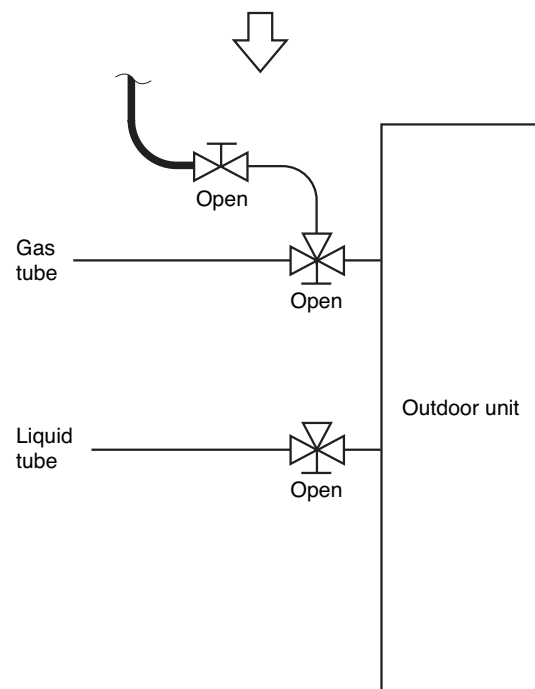

Fig. 10-6

11. TEST RUN

11-1. Preparing for Test Run

- **Before attempting to start the air conditioner, check the following:**

- (1) All loose matter is removed from the cabinet especially steel filings, bits of wire, and clips.
- (2) The control wiring is correctly connected and all electrical connections are tight.
- (3) The protective spacers for the compressor used for transportation have been removed. If not, remove them now.
- (4) The transportation pads for the indoor fan have been removed. If not, remove them now.
- (5) The power has been supplied to the unit for at least 5 hours before starting the compressor. The bottom of the compressor should be warm to the touch and the crankcase heater around the feet of the compressor should be hot to the touch. (Fig. 11-1)
- (6) Both the gas and liquid tube service valves are open. If not, open them now. (Fig. 11-2)
- (7) Request that the customer be present for the trial run.
Explain the contents of the instruction manual, then have the customer actually operate the system.
- (8) Be sure to give the instruction manual and warranty certificate to the customer.
- (9) When replacing the control PCB, be sure to make all the same settings on the new PCB as were in use before replacement.
The existing EEPROM is not changed, and is connected to the new control PCB.

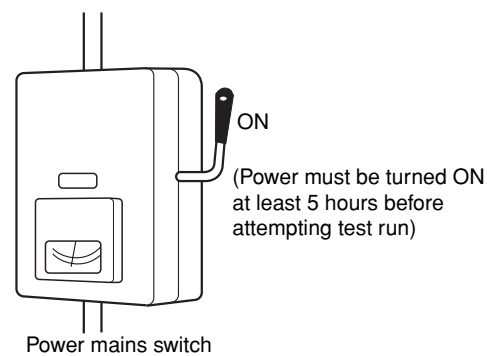

Fig. 11-1

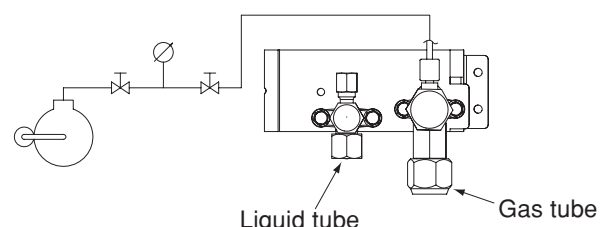

Fig. 11-2

■ X, T, U, K Type

11-2. Caution

- This unit may be used in a single-type refrigerant system where 1 outdoor unit is connected to 1 indoor unit.
- The indoor and outdoor unit control PCBs utilize a semiconductor memory element (EEPROM). The settings required for operation were made at the time of shipment. Only the correct combination of indoor and outdoor units can be used.
- This test run manual describes primarily the procedure when using the wired remote controller.

11-3. Test Run Procedure

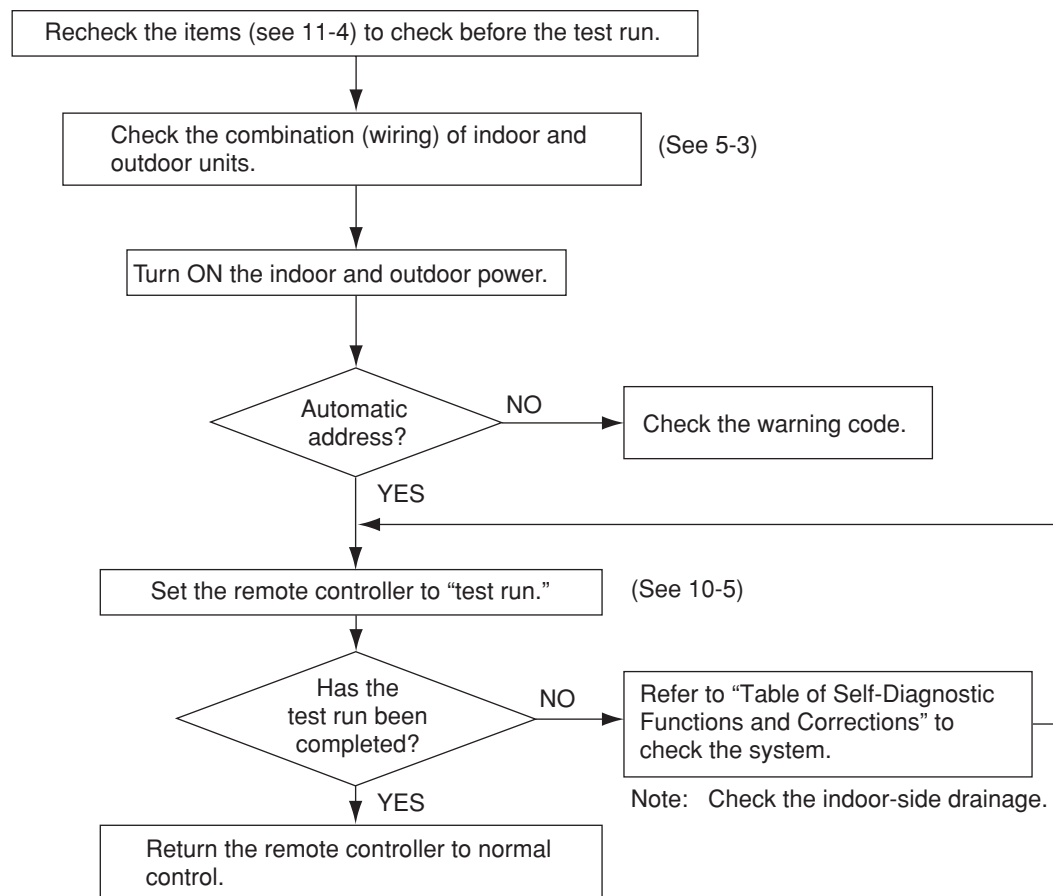
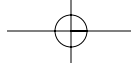





Fig. 11-3



11-4. Items to Check Before the Test Run

- (1) Turn the breaker ON at least 12 hours in advance in order to energize the crank case heater.
- (2) Fully open the closed valves on the liquid tube and gas tube sides.

11-5. Test Run Using the Remote Controller

- (1) Press and hold the remote controller  button for 4 seconds or longer. Then press the  button.
 - “TEST” appears in the LCD display during the test run.
 - Temperature control is not possible when test run mode is engaged.
(This mode places a large load on the devices. Use it only when performing the test run.)
- (2) Use either Heating or Cooling mode to perform the test run.
Note: The outdoor unit will not operate for approximately 3 minutes after the power is turned ON or after it stops operating.
- (3) If normal operation is not possible, a code appears on the remote controller LCD display.
Refer to the “Table of Self-Diagnostic Functions and Corrections” on the next page, and correct the problem.
- (4) After the test run is completed, press the  button again. Check that “TEST” disappears from the LCD display.
(This remote controller includes a function that cancels test run mode after 60 minutes have elapsed, in order to prevent continuous test run operation.)
- (5) For the test run of an inverter outdoor unit, operate the compressors for a minimum of 10 minutes.
 - * When performing a test run using a wired remote controller, operation is possible without attaching the cassette-type ceiling panel.
(“P09” will not be displayed.)

11-6. Precautions

- Request that the customer be present when the test run is performed. At this time, explain the operation manual and have the customer perform the actual steps.
- Be sure to pass the manuals and warranty certificate to the customer.
- Check that the AC 230 / 208 V power is not connected to the inter-unit control wiring connector terminal.
 - * If AC 230 / 208 V is accidentally applied, the indoor or outdoor unit control PCB fuse (0.5A for both indoor and outdoor units) will blow in order to protect the PCB. Correct the wiring connections, then disconnect the 2P connectors (indoor: blue, OC) (outdoor: blue, OC) that are connected to the PCB, and replace them with 2P connectors (indoor: brown, EMG) (outdoor: brown, EMG). (Refer to the figure below.) If operation is still not possible after changing the brown connectors, try cutting the varistor (VA002) (both indoor and outdoor).
(Be sure to turn the power OFF before performing this work.)

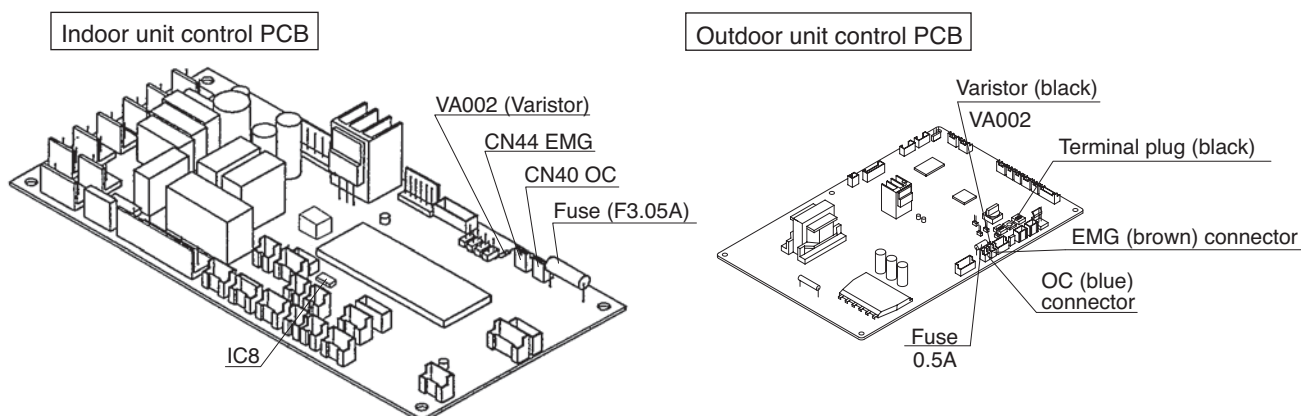
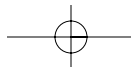
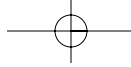

Fig. 11-4



11-7. Table of Self-Diagnostic Functions and Corrections (X, T, U, K Type)

Wired remote controller display	Indoor unit receiver lamp	Cause				Correction
		1:1 connection (single type)	Group connection	Simultaneous-operation multi system (flexible combination)	Control by main-sub remote controllers	
Nothing is displayed	Nothing is displayed	<ul style="list-style-type: none"> Remote controller is not connected correctly. Indoor unit power is not ON. 	<ul style="list-style-type: none"> Remote controller is not connected with indoor unit correctly Indoor unit power is not ON. 	<ul style="list-style-type: none"> Same as at left 	<ul style="list-style-type: none"> Same as at left 	<ul style="list-style-type: none"> Connect the remote controller correctly. Turn ON the indoor unit power.
E 0 1 displayed		<ul style="list-style-type: none"> Automatic address setting has not been completed. Inter-unit control wiring is cut or is not connected correctly. Remote controller is not connected correctly (remote controller receiving failure). 	<ul style="list-style-type: none"> Automatic address setting has not been completed. Inter-unit control wiring is cut or is not connected correctly. Remote controller is not connected with indoor unit correctly 	<ul style="list-style-type: none"> Same as at left 	<ul style="list-style-type: none"> Same as at left 	<ul style="list-style-type: none"> Check the remote controller and inter-unit control wiring. Perform automatic address setting (See 11-8-4).
E 0 2 displayed	Operating lamp is blinking.	<ul style="list-style-type: none"> Remote controller is not connected correctly (failure in transmission from remote controller to indoor unit). 	<ul style="list-style-type: none"> Remote controller is not connected with indoor unit correctly 	<ul style="list-style-type: none"> Same as at left 	<ul style="list-style-type: none"> Same as at left 	<ul style="list-style-type: none"> Connect the remote controller correctly.
E 0 9 displayed				<ul style="list-style-type: none"> 2 remote controllers are set as the main remote controller. 	<ul style="list-style-type: none"> 2 remote controllers are set as the main remote controller. 	<ul style="list-style-type: none"> Refer to 11-8-6 Main-sub remote control, and make the correct settings.
E 1 4 displayed				<ul style="list-style-type: none"> Remote controller crossover wiring is cut or is not connected correctly. 	<ul style="list-style-type: none"> Same as at left 	<ul style="list-style-type: none"> Check the remote controller crossover wiring. Perform automatic address setting again.
E 0 4 displayed		<ul style="list-style-type: none"> Indoor-outdoor inter-unit wiring is not connected correctly. 	<ul style="list-style-type: none"> Same as at left 	<ul style="list-style-type: none"> Same as at left 	<ul style="list-style-type: none"> Same as at left 	<ul style="list-style-type: none"> Connect the wiring correctly.
E 0 6 displayed	Standby lamp is blinking.		<ul style="list-style-type: none"> Indoor-outdoor inter-unit wiring is cut or is not connected correctly. 	<ul style="list-style-type: none"> Same as at left 	<ul style="list-style-type: none"> Same as at left 	<ul style="list-style-type: none"> Refer to 11-8 System Control, and make the correct settings.
E 1 5 displayed		<ul style="list-style-type: none"> Indoor unit capacity is too low. 	<ul style="list-style-type: none"> Same as at left 	<ul style="list-style-type: none"> Same as at left 	<ul style="list-style-type: none"> Same as at left 	<ul style="list-style-type: none"> Check that the total capacities of the indoor and outdoor units are appropriate.
E 1 6 displayed		<ul style="list-style-type: none"> Indoor unit capacity is too high. 	<ul style="list-style-type: none"> Same as at left 	<ul style="list-style-type: none"> Same as at left 	<ul style="list-style-type: none"> Same as at left 	<ul style="list-style-type: none"> Check that the total capacities of the indoor and outdoor units are appropriate.
E 2 0 displayed		<ul style="list-style-type: none"> No serial signal is being received at all from the indoor units. 	<ul style="list-style-type: none"> Same as at left 	<ul style="list-style-type: none"> Same as at left 	<ul style="list-style-type: none"> Same as at left 	<ul style="list-style-type: none"> Check that the indoor unit power is ON, and that the inter-unit control wiring is connected correctly.
P 0 5 displayed	Operation lamp and Standby lamp are blinking alternately.	<ul style="list-style-type: none"> Inter-unit circuit or open phase in the outdoor unit power Insufficient gas 	<ul style="list-style-type: none"> Reversed phase or open phase in the 3-phase power at one of the outdoor units in the group 	<ul style="list-style-type: none"> Reversed phase or open phase in the outdoor unit 3-phase power 	<ul style="list-style-type: none"> Same as at left 	<ul style="list-style-type: none"> Reverse 2 phases of the outdoor unit 3-phase power and connect them correctly.
L 0 2 displayed	Both the Operation lamp and Standby lamp are blinking together.	<ul style="list-style-type: none"> Indoor-outdoor unit type mismatch 	<ul style="list-style-type: none"> Same as at left 	<ul style="list-style-type: none"> Same as at left 	<ul style="list-style-type: none"> Same as at left 	<ul style="list-style-type: none"> Check that the indoor and outdoor unit types are correct.
L 1 3 displayed			<ul style="list-style-type: none"> Remote controller crossover wiring is connected to the indoor unit, however it is set for individual operation. 	<ul style="list-style-type: none"> Remote controller crossover wiring is connected to the indoor unit, however it is set for individual operation. 	<ul style="list-style-type: none"> Same as at left 	<ul style="list-style-type: none"> Perform automatic address setting (See 11-8).
L 0 7 displayed			<ul style="list-style-type: none"> Ceiling panel connector at one of the indoor units in the group is not connected correctly. 	<ul style="list-style-type: none"> Indoor unit ceiling panel connector is not connected correctly. 	<ul style="list-style-type: none"> Same as at left 	<ul style="list-style-type: none"> Connect the indoor unit ceiling panel connector correctly.
P 0 9 displayed	Timer lamp and Standby lamp are blinking alternately.	<ul style="list-style-type: none"> The indoor unit ceiling panel connector is not connected correctly. 	<ul style="list-style-type: none"> Same as at left 	<ul style="list-style-type: none"> Same as at left 	<ul style="list-style-type: none"> Same as at left 	<ul style="list-style-type: none"> Connect the indoor unit ceiling panel connector correctly.



11-8. Examples of Wiring Diagrams

11-8-1. Basic wiring diagram 1

Single-type system

- Be careful to avoid miswiring when connecting the wires. (Miswiring will damage the units.)

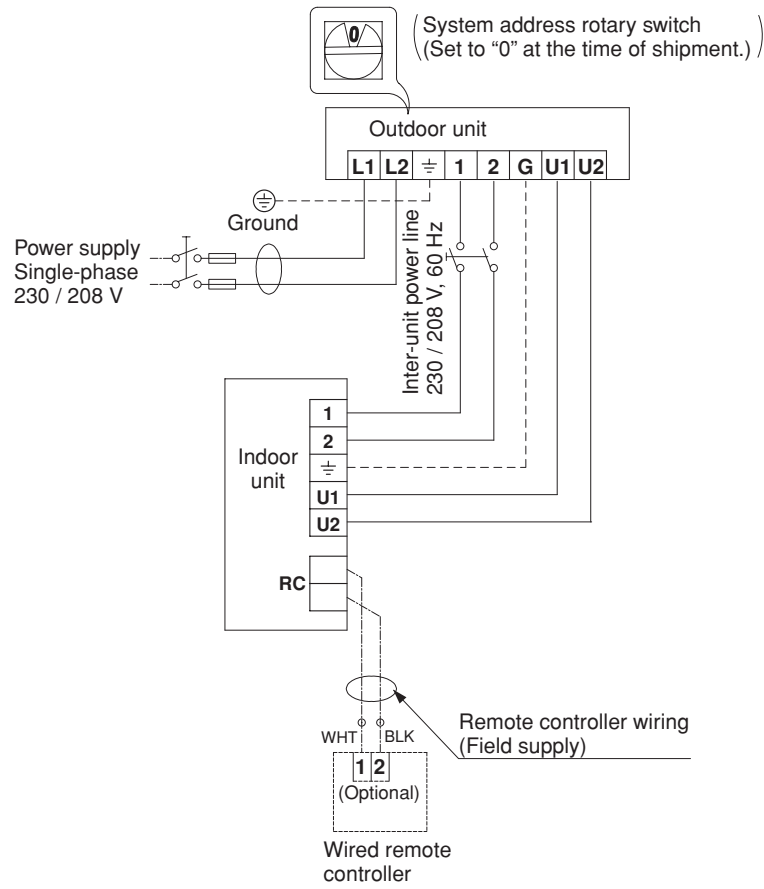
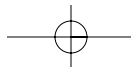

Fig. 11-5



11-8-2. Basic wiring diagram 2

Group control (when a central control device is not used)

- Simultaneous-operation multi system

A maximum of 8 indoor units can be connected to 1 remote controller.

Set the system address (refrigerant tubing system address) before turning on the remote power switch.

(Refer to 11-8-3. Setting the system addresses.)

(Set using the system address rotary switch on the outdoor unit control PCB.)

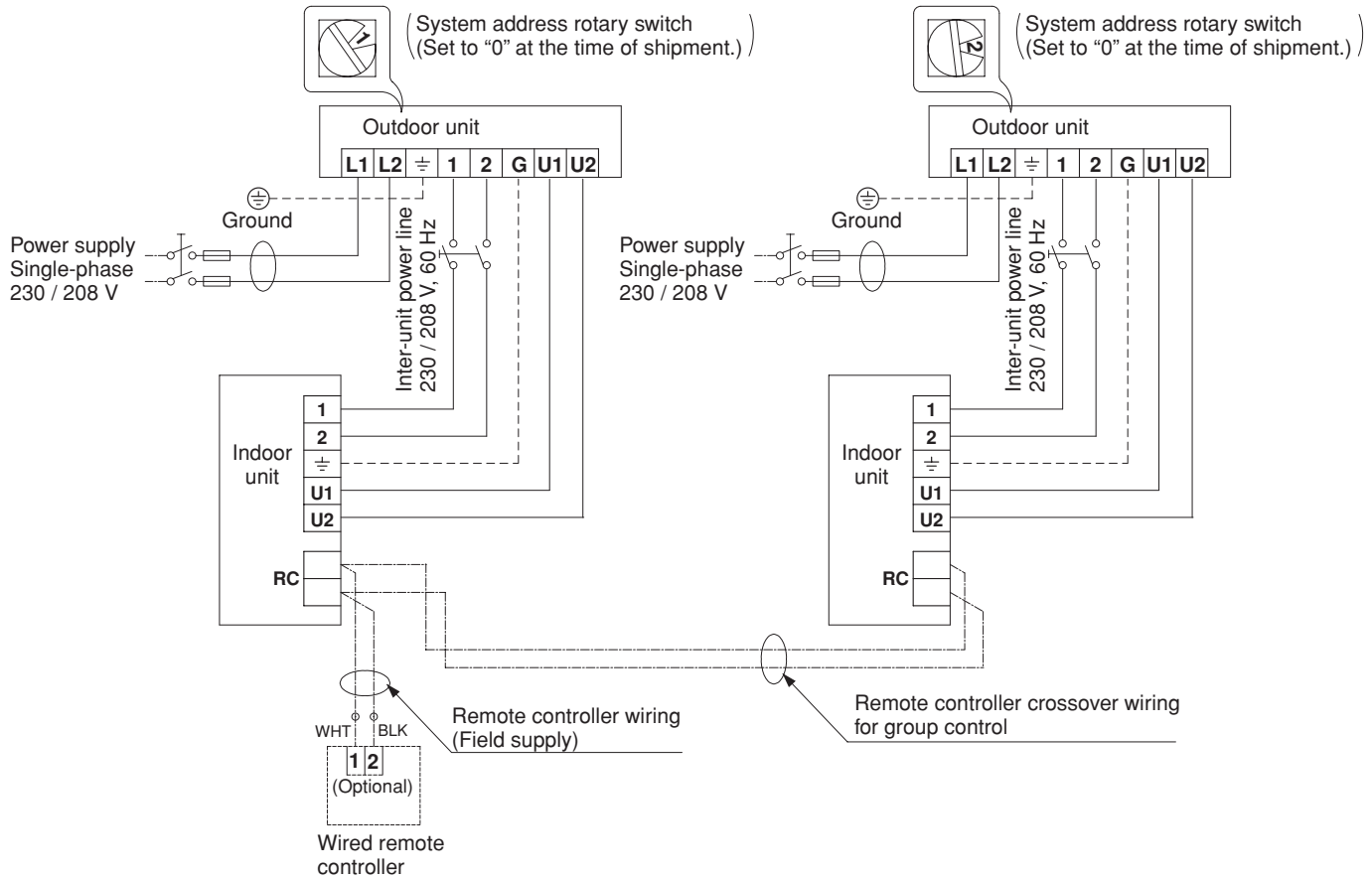

Fig. 11-6a

(Wiring procedure)

- (1) Connect the remote controller to the indoor unit remote controller wiring.

Use the remote controller connection wire coming from the indoor unit, and field-supply wire and a wire joint to complete the connection as shown in Fig. 11-6b. The remote controller connection wire coming from the indoor unit includes a connector, therefore cut off the connector and use the wire joint to connect the wire from the remote controller.

- (2) Connect the indoor units (U1, U2) and the outdoor units (1, 2). Connect the other outdoor units and indoor units (with different refrigerant systems) in the same way. Connect the inter-unit control wiring to the indoor units (U1, U2) for each refrigerant system. (Inter-unit control wiring)

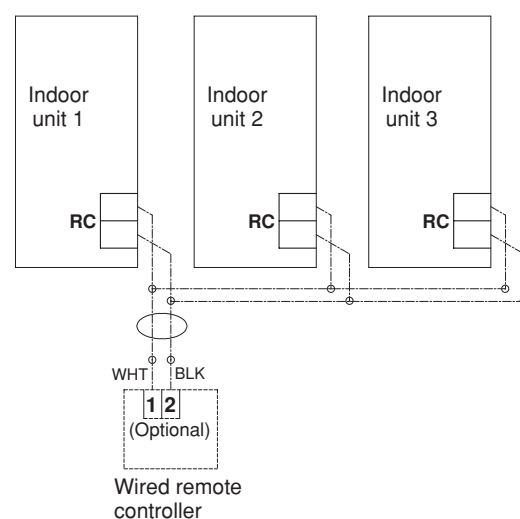
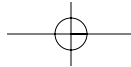

Fig. 11-6b



11-8-3. Setting the outdoor unit system addresses

For basic wiring diagram 2 (Set the system addresses: 1, 2, 3...)

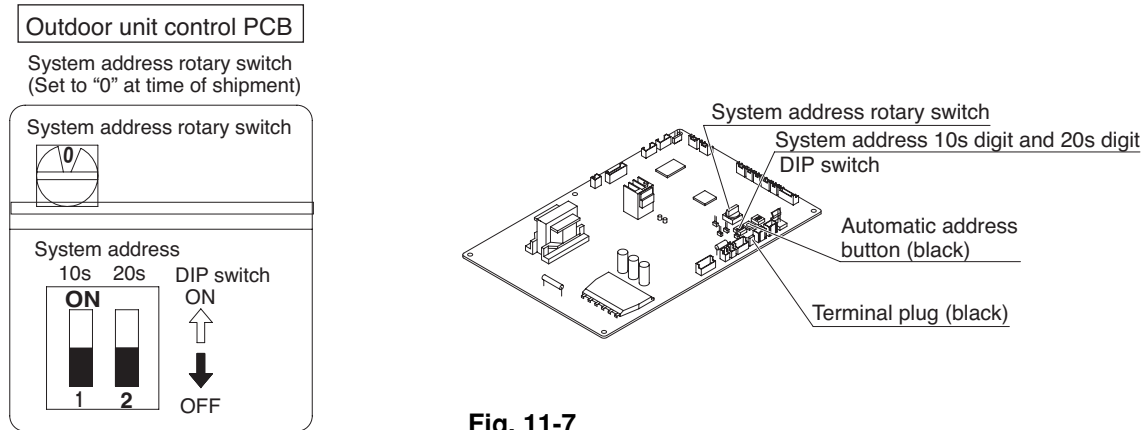

Fig. 11-7

System address No.	System address 10s digit (2P DIP switch)	System address 1s place (Rotary switch)
0 Automatic address (Setting at shipment = "0")	Both OFF 	"0" setting
1 (If outdoor unit is No. 1)	Both OFF 	"1" setting
2 (If outdoor unit is No. 2)	Both OFF 	"2" setting
11 (If outdoor unit is No. 11)	10s digit ON 	"1" setting
21 (If outdoor unit is No. 21)	20s digit ON 	"1" setting
30 (If outdoor unit is No. 30)	10s digit and 20s digit ON 	"0" setting

11-8-4. Automatic address setting using the remote controller

When the outdoor unit shown in 11-8-2. Basic wiring diagram 2 is used for group control of multiple outdoor units, use the remote controller to perform automatic address setting. (During automatic address setting, "SETTING" blinks on the remote controller display.)

- Press the remote controller timer time button and button simultaneously. (Hold for 4 seconds or longer.) Then press the button. (Item code "AA" appears: All systems automatic address setting.) (Automatic address setting is performed in sequence for all outdoor units from No. 1 to No. 30. When automatic address setting is completed, the units return to normal stopped status.)
- To select each refrigerant system individually and perform automatic address setting, press the remote controller timer time button and button simultaneously. (Hold for 4 seconds or longer.) Then press either the temperature setting or button. (Item code "A1" appears: Individual system automatic address setting) Use either the or button to select the outdoor unit to perform automatic address setting. (For example, when selected R.C.1 "R.C.1" is displayed.) Then press the button. (Automatic address setting is performed for refrigerant circuit 1.) When automatic address setting for circuit 1 is completed, the system returns to normal stopped status. In the same way, press the remote controller timer time button and button simultaneously to perform automatic address setting for a different R.C. (refrigerant circuit) if necessary. Then in the same way as above (use the button to display "R.C.2," for example), select the next circuit and perform automatic address setting.

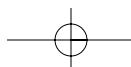

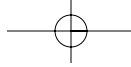

11-8-5. Indicating (marking) the indoor and outdoor unit combination number

Indicate (mark) the number after automatic address setting is completed.

- (1) So that the combination of each indoor unit can be easily checked when multiple units are installed, ensure that the indoor and outdoor unit numbers correspond to the system address number on the outdoor unit control PCB, and use a magic marker or similar means which cannot be easily erased to indicate the numbers in an easily visible location on the indoor units (near the indoor unit nameplates).

Example: (Outdoor) 1 - (Indoor) 1-1...(Outdoor) 2 - (Indoor) 2-2...

- (2) These numbers will be needed for maintenance. Be sure to indicate them.

- * Use the remote controller to check the addresses of the indoor units. Press and hold the button and button for 4 seconds or longer (simple settings mode). Then press the **UNIT** button and select the indoor address. (Each time the button is pressed, the address changes as follows: 1-1, 2-1,) The indoor unit fan operates only at the selected indoor unit. Confirm that correct fan is operating, and indicate address on the indoor unit.

Press the button again to return to the normal remote controller mode.

For details, refer to the separate handbook.

11-8-6. Main-sub remote controller control

Control using 2 remote controller switches

Main-sub remote controller control refers to the use of 2 remote controllers to control 1 indoor unit.

(A maximum of 2 remote controllers can be connected.)

● Connecting 2 remote controllers to control 1 indoor unit

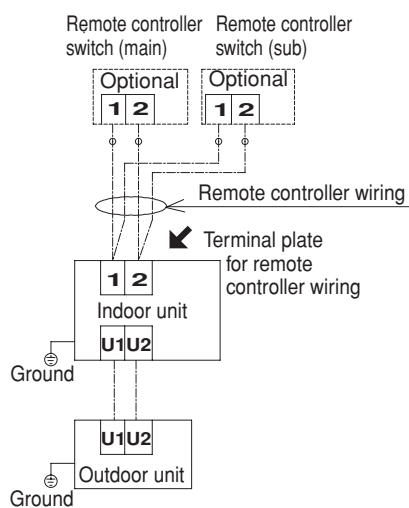

(Setting procedure)

- (1) Set 1 of the 2 connected remote controllers as the main remote controller.
- (2) On the other remote controller (sub remote controller), change the remote controller address connector on the reverse side of the remote controller switch PCB from the Main position to the Sub position.

The remote controller will now function as the sub remote controller.

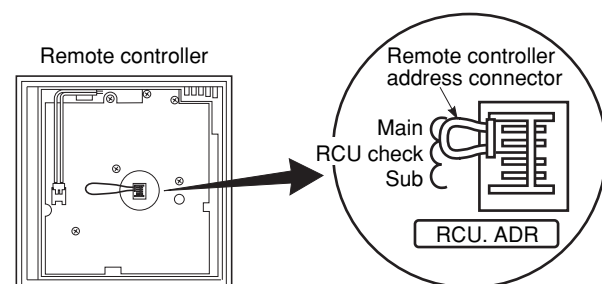
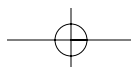

Fig. 11-8



Free Manuals Download Website

<http://myh66.com>

<http://usermanuals.us>

<http://www.somanuals.com>

<http://www.4manuals.cc>

<http://www.manual-lib.com>

<http://www.404manual.com>

<http://www.luxmanual.com>

<http://aubethermostatmanual.com>

Golf course search by state

<http://golfingnear.com>

Email search by domain

<http://emailbydomain.com>

Auto manuals search

<http://auto.somanuals.com>

TV manuals search

<http://tv.somanuals.com>