

TECHNICAL & SERVICE MANUAL



INDOOR UNIT : XMHS0972 & PNR-XS1872
XMHS1272 & PNR-XS1872
XHS1872 & PNR-XS1872

FILE NO.

Destination: North America

DC INVERTER MULTI-SYSTEM AIR CONDITIONER

Capacity	Indoor Model No. Body (Panel)	Product Code No. Body (Panel)
9,000BTU / h	XMHS0972 (PNR-XS1872)	1 852 353 74 (1 852 352 11)
11,900BTU / h	XMHS1272 (PNR-XS1872)	1 852 353 73 (1 852 352 11)
17,500BTU / h	XHS1872 (PNR-XS1872)	1 852 352 07 (1 852 352 11)

Semi-Concealed Type Indoor Unit

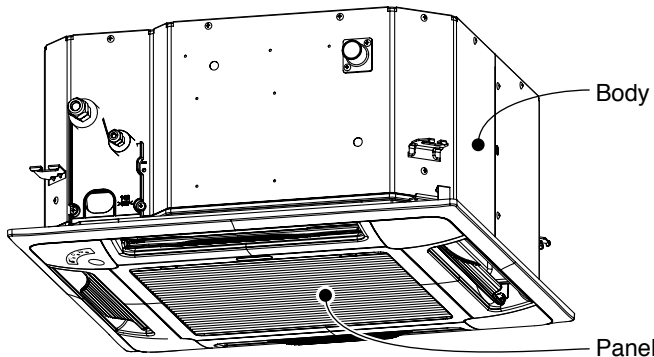

< Applicable Multi-Outdoor Units >

- CMH1972 (3-room multi unit)
- CMH2472 (4-room multi unit)
- CMH3172 (4-room multi unit)

NOTE

For details about the combinations, refer to "Unit Combination Table" in the T. Service Manual for the Multi Outdoor Units.

XMHS0972 (Body) & PNR-XS1872 (Panel)
XMHS1272 (Body) & PNR-XS1872 (Panel)
XHS1872 (Body) & PNR-XS1872 (Panel)



Wireless Remote Controller

























Wired Remote Controller
(Option)









R410A

REFERENCE NO. SM700814

SAFETY PRECAUTIONS

- Before doing repair work, please read the " SAFETY PRECAUTIONS" carefully and fully understand them.
- The precautionary items here are divided into " Warning" and " Caution" items.
Items in particular which may cause death or serious injury to the service personnel if the work is not performed correctly, are included in the " Warning" table.
However, even precautionary items identified as " Caution" also have the potential for serious consequences if not performed correctly.
Important safety precautions are described for all items in both categories. Be sure to carefully follow all of them.
- Symbol Indication
 -  : This symbol indicates items to which we need to pay attention.
In this triangle, a definite precautionary item is described.
 -  : This symbol indicates the item to be prohibited.
In or close to this circle, a prohibited item is described.
 -  : This symbol indicates the items requiring special attention or instruction.
In or close to this circle, a prohibited item is described.
- After doing repair work, perform a test run to confirm that there are no abnormalities.
At the same time, explain the precautions in use to the user.

 Warning	
Before performing an overhaul, disconnect the power plug or power cable from the unit. Performing the work with the power supplied to the unit, may cause an electric shock.	
When repair work or circuit inspection that requires power supply for the air conditioner, is to be performed, do not touch the charging section. Doing so may cause an electric shock.	 Prohibit
For the step-up capacitor attached to the electric section, perform the repair work after sufficiently discharging it. Insufficient capacitor discharge may cause an electric shock.	
Do not perform repair work on the electric sections with wet hands. Doing so may cause an electric shock.	 Prohibit
Do not start or stop the air conditioner by means of connecting or disconnecting the power plug. Doing so may cause an electric shock or fire.	 Prohibit
When conducting repair work only use components included in the parts list for the corresponding unit and perform the work with the appropriate tools. Incorrect or poor repair work may cause an electric shock or fire.	
Never modify the unit. Doing so may cause an electric shock or fire.	 Prohibit
Perform all electric work according to local applicable regulations related to electrical equipment or interior wiring regulation and make sure to use the exclusive circuit. Insufficient capacity to the electric circuit or defective arrangement results may cause an electric shock or fire.	
Make sure to replace any power cable or lead wire showing any signs of scratch or deterioration. Failure to do so may cause an electric shock, overheating or fire.	
Make sure that there is no dust on or slack in the power plug and insert fully into the socket. Dust or incomplete connections may cause an electric shock or fire.	
Do not damage or process the power cord, as it may cause an electric shock or fire.	 Prohibit
For the wiring between the indoor unit and outdoor unit, securely fix the specified cable onto the terminal plate. Poorly fixed wiring may cause a heat or fire.	
After connecting the wiring between the indoor unit and outdoor unit, attach the terminal cover securely. Incomplete attachment of the terminal cover may cause overheating or fire.	

 Warning	
If refrigerant gas blows off during the work, do not touch the refrigerant gas as it may cause frostbite.	 Prohibit
If refrigerant gas leaks during the work, ventilate the room. If refrigerant gas catches fire, harmful gas may be generated.	
Do not mix any gas other than the specified refrigerant gas in the refrigerating cycle. If air or other contaminants mix with the gas, pressure will become extremely high in the refrigerating cycle, which may cause a unit breakdown."	 Prohibit
When the welded section of the compressor intake or discharge pipe is to be disconnected, perform it in a well-ventilated place after sufficiently recovering the refrigerant gas. Any residue gas may jet out refrigerant or refrigerating machine oil, which may cause an injury.	
When the work is to be performed in a high place (About 2 meters or more), make sure to wear a safety helmet, gloves and safety belt. Insufficient safety gear may cause a serious injury in case of a fall.	
When the unit is to be relocated, confirm that the new installation location has sufficient strength for the weight of the unit. Insufficient strength of the installation location and incomplete installation work may cause an injury due to the unit falling.	
When the remote controller batteries are replaced, dispose of the old batteries out of the reach of children. If a child swallows a battery, make sure that the child gets immediate medical attention.	













 Caution	
Do not wash the air conditioner with water, as this may cause an electric shock or fire.	 Prohibit
For the repair work in places with high humidity or moisture, make sure to ground the unit. Failure to do so may cause an electric shock.	
Confirm that the component attachment position, wiring condition, soldering condition and connector connection are normal. If not, it may cause overheating or fire.	
Confirm that the temperature around the compressor is not too high, and then perform the repair work. Failure to do so may cause a burn.	
Perform welding work in a place with good ventilation. If the work is performed in a poorly ventilated area, it might cause a lack of oxygen.	
If the installation plate or attachment frame has deteriorated due to corrosion, etc., replace it. Failure to do so may cause an injury due to the unit falling.	
When the cleaning is to be performed, make sure to turn off the power and pull out the plug. Touching the fan that is rotating at high speed may result in an injury.	
When the indoor unit is to be removed, do not place it on an incline. Doing so may cause wet furniture because water left inside may trickle down.	 Prohibit
Do not hold the sharp end of the unit or the aluminum fins, as it may cause an injury to your hand or finger.	 Prohibit
After repairs, make sure to measure the insulation resistance and confirm that the value is 1 Mohm or more. Any insulation error may cause an electric shock.	
After repairs, make sure to check the drainage of the indoor unit. Inappropriate drainage may cause wet furniture and floors due to water leakage.	

TABLE OF CONTENTS

	Page
⚠ SAFETY PRECAUTIONS	2
TABLE OF CONTENTS	4
■ APPLICABLE MULTI-OUTDOOR UNITS	6
1. OPERATING RANGE	7
2. SPECIFICATIONS	
2-1. Unit Specifications	8
2-2. Major Component Specifications	14
2-3. Other Component Specifications	17
3. DIMENSIONAL DATA	18
4. REFRIGERANT FLOW DIAGRAM	
4-1. Refrigerant Flow Diagram	19
5. ELECTRICAL DATA	
5-1. Electric Wiring Diagrams	20
6. MAINTENANCE	
6-1. Disassembly Procedure	21
7. FUNCTIONS	
7-1. Operation Functions	28
7-2. Protective Functions	30
8. TROUBLESHOOTING	
8-1. Precautions before Performing Inspection or Repair	31
8-2. Method of Self-Diagnostics	31
8-3. Checking the Indoor and Outdoor Units	33
8-4. Trouble Diagnosis of Fan Motor	37
8-5. Noise Malfunction and Electromagnetic Interference	38
APPENDIX A INSTRUCTION MANUAL	A-1
(XHMS0972 & PNR-XS1872, XHMS1272 & PNR-XS1872)	
APPENDIX B INSTRUCTION MANUAL	A-2
(XHS1872 & PNR-XS1872)	
APPENDIX C INSTALLATION INSTRUCTIONS	A-3
(XHMS0972 & PNR-XS1872, XHMS1272 & PNR-XS1872,)	
(XHS1872 & PNR-XS1872)	

	Page
APPENDIX D INSTRUCTION MANUAL (STK-RCS-7TWSUA)	A-4
APPENDIX E INSTALLATION INSTRUCTIONS (STK-RCS-7TWSUA)	A-5

■ APPLICABLE MULTI-OUTDOOR UNITS

Multi-Outdoor Unit	3-Room	4-Room	4-Room
Indoor Unit	CMH1972	CMH2472	CMH3172
XMHS0972 & PNR-XS1872	YES	YES	YES
XMHS1272 & PNR-XS1872	YES	YES	YES
XHS1872 & PNR-XS1872	YES	YES	YES

1. OPERATING RANGE

	Temperature	Indoor Air Intake Temp.	Outdoor Air Intake Temp.
Cooling	Maximum	95 °F D.B. / 71 °F W.B.	115 °F D.B.
	Minimum	67 °F D.B. / 57 °F W.B.	67 °F D.B.
Heating	Maximum	80 °F D.B. / 67 °F W.B.	75 °F D.B. / 65 °F W.B.
	Minimum	— D.B. / — W.B.	0 °F D.B.

2. SPECIFICATIONS

2-1. Unit Specifications

2-1-1. Indoor Unit XMHS0972 & PNR-XS1872

<230V>

Type			Semi-Concealed Type Indoor Unit	
Voltage Rating			230V Single-Phase 60Hz	
Performance	Total Capacity	BTU/h	Cooling	Heating
		kW	9,000	12,300
	Air Circulation (High)	ft ³ /min (m ³ /h)	2.65	3.6
	Moisture Removal (High)	Pints/h	221 (375)	247 (420)
Electrical Rating	Available Voltage Range	V	187 to 253	
	Running Amperes	A	0.1	0.12
	Power Input	W	16	18
	-	-	-	
Features	Controls / Temperature Control		Microprocessor / I.C. Thermister	
	Control Unit		Wireless Remote Control Unit	
	Timer		24-Hour ON or OFF Timer, 1-Hour OFF Timer	
	Fan Speeds	Indoor	Auto and 3 steps	
	Airflow Direction (Indoor)	Horizontal	-	
		Vertical	Auto	
	Air Filter		Washable, Anti-Mold	
	Refrigerant		R410A	
	Operation Sound	Indoor : Hi/Me/Lo dB-A	33 / 32 / 31	34 / 33 / 32
	Refrigerant Tubing Connections		Flare Type	
	Refrigerant	Narrow tube inch (mm)	1/4 (6.35)	
	Tube Diameter	Wide tube inch (mm)	3/8 (9.52)	
	Accessories		Air Clean Filter	
	Wired Remote Controller (Option)		STK-RCS-7TWSUA	

Dimensions & Weight (Indoor Unit)			Indoor Unit (XMHS0972 & PNR-XS1872)	Individual Unit	
				Body (XMHS0972)	Panel (PNR-XS1872)
Unit Dimensions	Height	inch (mm)	12-5/16 (313)	11-5/32 (283)	1-9/16 (40)
	Width	inch (mm)	24-19/32 (625)	22-5/8 (575)	24-19/32 (625)
	Depth	inch (mm)	24-19/32 (625)	22-5/8 (575)	24-19/32 (625)
Package Dimensions	Height	inch (mm)	-	11-13/32 (290)	4-1/8 (105)
	Width	inch (mm)	-	24-13/16 (630)	26-3/16 (665)
	Depth	inch (mm)	-	28-1/8 (714)	26-11/16 (678)
Weight	Net	lb. (kg)	41.3 (18.7)	35.3 (16)	6.0 (2.7)
	Shipping	lb. (kg)	-	41.9 (19)	7.7 (3.5)
Shipping Volume		cu.ft (m ³)	-	4.59 (0.13)	1.65 (0.04)

DATA SUBJECT TO CHANGE WITHOUT NOTICE.

Remarks: Rating conditions are:

Cooling: Indoor air temperature 80°F D.B. / 67°F W.B.
Outdoor air temperature 95°F D.B. / 75°F W.B.

Heating: Indoor air temperature 70°F D.B.
Outdoor air temperature 47°F D.B. / 43°F W.B.

Indoor Unit **XMHS0972 & PNR-XS1872**

<208V>

Type			Semi-Concealed Type Indoor Unit	
Voltage Rating			208V Single-Phase 60Hz	
Performance			Cooling	Heating
	Total Capacity	BTU/h	9,000	12,300
		kW	2.65	3.6
	Air Circulation (High)	ft ³ /min (m ³ /h)	221 (375)	247 (420)
Moisture Removal (High)	Pints/h	3.4	-	
Electrical Rating	Available Voltage Range		V 187 to 253	
	Running Amperes		A 0.11	0.13
	Power Input		W 15	17
			-	
Features	Controls / Temperature Control		Microprocessor / I.C. Thermister	
	Control Unit		Wireless Remote Control Unit	
	Timer		24-Hour ON or OFF Timer, 1-Hour OFF Timer	
	Fan Speeds	Indoor	Auto and 3 steps	
	Airflow Direction (Indoor)	Horizontal	-	
		Vertical	Auto	
	Air Filter		Washable, Anti-Mold	
	Refrigerant		R410A	
	Operation Sound	Indoor : Hi/Me/Lo	dB-A 33 / 32 / 31	34 / 33 / 32
	Refrigerant Tubing Connections		Flare Type	
	Refrigerant	Narrow tube	inch (mm)	1/4 (6.35)
	Tube Diameter	Wide tube	inch (mm)	3/8 (9.52)
	Accessories		Air Clean Filter	
	Wired Remote Controller (Option)		STK-RCS-7TWSUA	

Dimensions & Weight (Indoor Unit)			Indoor Unit (XMHS0972 & PNR-XS1872)	Individual Unit	
				Body (XMHS0972)	Panel (PNR-XS1872)
Unit Dimensions	Height	inch (mm)	12-5/16 (313)	11-5/32 (283)	1-9/16 (40)
	Width	inch (mm)	24-19/32 (625)	22-5/8 (575)	24-19/32 (625)
	Depth	inch (mm)	24-19/32 (625)	22-5/8 (575)	24-19/32 (625)
Package Dimensions	Height	inch (mm)	-	11-13/32 (290)	4-1/8 (105)
	Width	inch (mm)	-	24-13/16 (630)	26-3/16 (665)
	Depth	inch (mm)	-	28-1/8 (714)	26-11/16 (678)
Weight	Net	lb. (kg)	41.3 (18.7)	35.3 (16)	6.0 (2.7)
	Shipping	lb. (kg)	-	41.9 (19)	7.7 (3.5)
Shipping Volume		cu.ft (m ³)	-	4.59 (0.13)	1.65 (0.04)

DATA SUBJECT TO CHANGE WITHOUT NOTICE.

Remarks: Rating conditions are:

Cooling: Indoor air temperature 80°F D.B. / 67°F W.B. Heating: Indoor air temperature 70°F D.B.
 Outdoor air temperature 95°F D.B. / 75°F W.B. Outdoor air temperature 47°F D.B. / 43°F W.B.

Indoor Unit **XMHS1272 & PNR-XS1872**

<230V>

Type			Semi-Concealed Type Indoor Unit	
Voltage Rating			230V Single-Phase 60Hz	
Performance			Cooling	Heating
	Total Capacity	BTU/h	11,900	13,600
		kW	3.5	4.0
	Air Circulation (High)	ft ³ /min (m ³ /h)	235 (400)	268 (455)
Moisture Removal (High)	Pints/h	4.26	-	
Electrical Rating	Available Voltage Range		V 187 to 253	
	Running Amperes		A 0.11	0.13
	Power Input		W 17	19
			-	
Features	Controls / Temperature Control		Microprocessor / I.C. Thermister	
	Control Unit		Wireless Remote Control Unit	
	Timer		24-Hour ON or OFF Timer, 1-Hour OFF Timer	
	Fan Speeds	Indoor	Auto and 3 steps	
	Airflow Direction (Indoor)	Horizontal	-	
		Vertical	Auto	
	Air Filter		Washable, Anti-Mold	
	Refrigerant		R410A	
	Operation Sound	Indoor : Hi/Me/Lo	dB-A 34 / 32 / 31	35 / 34 / 32
	Refrigerant Tubing Connections		Flare Type	
	Refrigerant	Narrow tube	inch (mm)	1/4 (6.35)
	Tube Diameter	Wide tube	inch (mm)	3/8 (9.52)
	Accessories		Air Clean Filter	
	Wired Remote Controller (Option)		STK-RCS-7TWSUA	

Dimensions & Weight (Indoor Unit)			Indoor Unit (XMHS1272 & PNR-XS1872)	Individual Unit	
				Body (XMHS1272)	Panel (PNR-XS1872)
Unit Dimensions	Height	inch (mm)	12-5/16 (313)	11-5/32 (283)	1-9/16 (40)
	Width	inch (mm)	24-19/32 (625)	22-5/8 (575)	24-19/32 (625)
	Depth	inch (mm)	24-19/32 (625)	22-5/8 (575)	24-19/32 (625)
Package Dimensions	Height	inch (mm)	-	11-13/32 (290)	4-1/8 (105)
	Width	inch (mm)	-	24-13/16 (630)	26-3/16 (665)
	Depth	inch (mm)	-	28-1/8 (714)	26-11/16 (678)
Weight	Net	lb. (kg)	41.3 (18.7)	35.3 (16)	6.0 (2.7)
	Shipping	lb. (kg)	-	41.9 (19)	7.7 (3.5)
Shipping Volume		cu.ft (m ³)	-	4.59 (0.13)	1.65 (0.04)

DATA SUBJECT TO CHANGE WITHOUT NOTICE.

Remarks: Rating conditions are:

Cooling: Indoor air temperature 80°F D.B. / 67°F W.B. Heating: Indoor air temperature 70°F D.B.
 Outdoor air temperature 95°F D.B. / 75°F W.B. Outdoor air temperature 47°F D.B. / 43°F W.B.

Indoor Unit **XMHS1272 & PNR-XS1872**

<208V>

Type			Semi-Concealed Type Indoor Unit	
Voltage Rating			208V Single-Phase 60Hz	
Performance			Cooling	Heating
	Total Capacity	BTU/h	11,900	13,600
		kW	3.5	4.0
	Air Circulation (High)	ft ³ /min (m ³ /h)	235 (400)	268 (455)
	Moisture Removal (High)	Pints/h	4.26	-
Electrical Rating	Available Voltage Range		V 187 to 253	
	Running Amperes		A 0.12	0.14
	Power Input		W 16	18
			-	
Features	Controls / Temperature Control		Microprocessor / I.C. Thermister	
	Control Unit		Wireless Remote Control Unit	
	Timer		24-Hour ON or OFF Timer, 1-Hour OFF Timer	
	Fan Speeds	Indoor	Auto and 3 steps	
	Airflow Direction (Indoor)	Horizontal	-	
		Vertical	Auto	
	Air Filter		Washable, Anti-Mold	
	Refrigerant		R410A	
	Operation Sound	Indoor : Hi/Me/Lo	dB-A 34 / 32 / 31	35 / 34 / 32
	Refrigerant Tubing Connections		Flare Type	
	Refrigerant	Narrow tube	inch (mm)	1/4 (6.35)
	Tube Diameter	Wide tube	inch (mm)	3/8 (9.52)
	Accessories		Air Clean Filter	
	Wired Remote Controller (Option)		STK-RCS-7TWSUA	

Dimensions & Weight (Indoor Unit)			Indoor Unit (XMHS1272 & PNR-XS1872)	Individual Unit	
				Body (XMHS1272)	Panel (PNR-XS1872)
Unit Dimensions	Height	inch (mm)	12-5/16 (313)	11-5/32 (283)	1-9/16 (40)
	Width	inch (mm)	24-19/32 (625)	22-5/8 (575)	24-19/32 (625)
	Depth	inch (mm)	24-19/32 (625)	22-5/8 (575)	24-19/32 (625)
Package Dimensions	Height	inch (mm)	-	11-13/32 (290)	4-1/8 (105)
	Width	inch (mm)	-	24-13/16 (630)	26-3/16 (665)
	Depth	inch (mm)	-	28-1/8 (714)	26-11/16 (678)
Weight	Net	lb. (kg)	41.3 (18.7)	35.3 (16)	6.0 (2.7)
	Shipping	lb. (kg)	-	41.9 (19)	7.7 (3.5)
Shipping Volume		cu.ft (m ³)	-	4.59 (0.13)	1.65 (0.04)

DATA SUBJECT TO CHANGE WITHOUT NOTICE.

Remarks: Rating conditions are:

Cooling: Indoor air temperature 80°F D.B. / 67°F W.B. Heating: Indoor air temperature 70°F D.B.
 Outdoor air temperature 95°F D.B. / 75°F W.B. Outdoor air temperature 47°F D.B. / 43°F W.B.

Indoor Unit **XHS1872 & PNR-XS1872**

<230V>

Type			Semi-Concealed Type Indoor Unit	
Voltage Rating			230V Single-Phase 60Hz	
Performance			Cooling	Heating
	Total Capacity	BTU/h	17,500	20,400
		kW	5.15	6.0
	Air Circulation (High)	ft ³ /min (m ³ /h)	341 (580)	383 (650)
	Moisture Removal (High)	Pints/h	4.89	-
Electrical Rating	Available Voltage Range		V 187 to 253	
	Running Amperes		A 0.15	0.19
	Power Input		W 22	27
			-	
Features	Controls / Temperature Control		Microprocessor / I.C. Thermister	
	Control Unit		Wireless Remote Control Unit	
	Timer		24-Hour ON or OFF Timer, 1-Hour OFF Timer	
	Fan Speeds	Indoor	Auto and 3 steps	
	Airflow Direction (Indoor)	Horizontal	-	
		Vertical	Auto	
	Air Filter		Washable, Anti-Mold	
	Refrigerant		R410A	
	Operation Sound	Indoor : Hi/Me/Lo	dB-A 44 / 40 / 36	44 / 40 / 36
	Refrigerant Tubing Connections		Flare Type	
	Refrigerant	Narrow tube	inch (mm) 1/4 (6.35)	
	Tube Diameter	Wide tube	inch (mm) 1/2 (12.7)	
	Accessories		Air Clean Filter	
	Wired Remote Controller (Option)		STK-RCS-7TWSUA	

Dimensions & Weight (Indoor Unit)			Indoor Unit (XHS1872 & PNR-XS1872)	Individual Unit	
				Body (XHS1872)	Panel (PNR-XS1872)
Unit Dimensions	Height	inch (mm)	12-5/16 (313)	11-5/32 (283)	1-9/16 (40)
	Width	inch (mm)	24-19/32 (625)	22-5/8 (575)	24-19/32 (625)
	Depth	inch (mm)	24-19/32 (625)	22-5/8 (575)	24-19/32 (625)
Package Dimensions	Height	inch (mm)	-	11-13/32 (290)	4-1/8 (105)
	Width	inch (mm)	-	24-13/16 (630)	26-3/16 (665)
	Depth	inch (mm)	-	28-1/8 (714)	26-11/16 (678)
Weight	Net	lb. (kg)	41.3 (18.7)	35.3 (16)	6.0 (2.7)
	Shipping	lb. (kg)	-	41.9 (19)	7.7 (3.5)
Shipping Volume		cu.ft (m ³)	-	4.59 (0.13)	1.65 (0.04)

DATA SUBJECT TO CHANGE WITHOUT NOTICE.

Remarks: Rating conditions are:

Cooling: Indoor air temperature 80°F D.B. / 67°F W.B. Heating: Indoor air temperature 70°F D.B.
 Outdoor air temperature 95°F D.B. / 75°F W.B. Outdoor air temperature 47°F D.B. / 43°F W.B.

Indoor Unit **XHS1872 & PNR-XS1872**

<208V>

Type			Semi-Concealed Type Indoor Unit	
Voltage Rating			208V Single-Phase 60Hz	
Performance			Cooling	Heating
	Total Capacity	BTU/h	17,500	20,400
		kW	5.15	6.0
	Air Circulation (High)	ft ³ /min (m ³ /h)	341 (580)	383 (650)
	Moisture Removal (High)	Pints/h	4.89	-
Electrical Rating	Available Voltage Range		V 187 to 253	
	Running Amperes		A 0.16	0.2
	Power Input		W 22	27
			-	
Features	Controls / Temperature Control		Microprocessor / I.C. Thermister	
	Control Unit		Wireless Remote Control Unit	
	Timer		24-Hour ON or OFF Timer, 1-Hour OFF Timer	
	Fan Speeds	Indoor	Auto and 3 steps	
	Airflow Direction (Indoor)	Horizontal	-	
		Vertical	Auto	
	Air Filter		Washable, Anti-Mold	
	Refrigerant		R410A	
	Operation Sound	Indoor : Hi/Me/Lo	dB-A 44 / 40 / 36	44 / 40 / 36
	Refrigerant Tubing Connections		Flare Type	
	Refrigerant	Narrow tube	inch (mm) 1/4 (6.35)	
	Tube Diameter	Wide tube	inch (mm) 1/2 (12.7)	
	Accessories		Air Clean Filter	
	Wired Remote Controller (Option)		STK-RCS-7TWSUA	

Dimensions & Weight (Indoor Unit)			Indoor Unit (XHS1872 & PNR-XS1872)	Individual Unit	
				Body (XHS1872)	Panel (PNR-XS1872)
Unit Dimensions	Height	inch (mm)	12-5/16 (313)	11-5/32 (283)	1-9/16 (40)
	Width	inch (mm)	24-19/32 (625)	22-5/8 (575)	24-19/32 (625)
	Depth	inch (mm)	24-19/32 (625)	22-5/8 (575)	24-19/32 (625)
Package Dimensions	Height	inch (mm)	-	11-13/32 (290)	4-1/8 (105)
	Width	inch (mm)	-	24-13/16 (630)	26-3/16 (665)
	Depth	inch (mm)	-	28-1/8 (714)	26-11/16 (678)
Weight	Net	lb. (kg)	41.3 (18.7)	35.3 (16)	6.0 (2.7)
	Shipping	lb. (kg)	-	41.9 (19)	7.7 (3.5)
Shipping Volume		cu.ft (m ³)	-	4.59 (0.13)	1.65 (0.04)

DATA SUBJECT TO CHANGE WITHOUT NOTICE.

Remarks: Rating conditions are:

Cooling: Indoor air temperature 80°F D.B. / 67°F W.B. Heating: Indoor air temperature 70°F D.B.
 Outdoor air temperature 95°F D.B. / 75°F W.B. Outdoor air temperature 47°F D.B. / 43°F W.B.

2-2. Major Component Specifications

2-2-1. Indoor Unit

Indoor Unit (Body) **XMHS0972**

Control PCB	
Part No.	CB-XMHS0972
Controls	Microprocessor
Control Circuit Fuse	250V 3A

Remote Control Unit	RCS-7MHVPSW4U
---------------------	---------------

Fan	
Type	Turbo
Q'ty ... Dia. and Length	inch (mm) 1 ... D12-5/8 / L5-3/4 (D322/L147)

Fan Motor	
Type	DC Motor
Model ... Q'ty	SIC-69FV-D866-1 ... 1
No. of Poles	8
Rough Measure RPM (Cool / Heat)	440 / 490
Rating	Voltage / Nominal Output DC280V / 23W
Coil Resistance (Ambient Temp. 68 °F (20 °C))	Ohm -
Safety Device	Internal Controller
Type	Over- Current Protection
	Over- Heat Protection
Run Capacitor	Micro F -
	VAC -

Drain Pump	
Model ... Q'ty	PLD-12230ST-1 ... 1
Rating	Voltage, Hz AC208 to 240V, 60Hz
	Input W 10.8
Coil Resistance (Ambient Temp. 68 °F (20 °C))	Ohm 333 +/- 10%
Safety Device	Thermal Fuse
Type	Open °F (°C) 293 (145)

Heat Exchanger Coil	
Coil	Aluminum Plate Fin / Copper Tube
Rows	2
Fins per inch	18.1
Face Area	ft ² (m ²) 2.94 (0.273)

DATA SUBJECT TO CHANGE WITHOUT NOTICE.

Indoor Unit (Panel) **PNR-XS1872**

Flap Motor	
Type	Stepping Motor
Model ... Q'ty	MP24ZN-12V ... 2
Rating	DC 12V
Coil Resistance (Ambient Temp. 77 °F (25 °C))	Ohm Each Pair of Terminal : 380 +/- 7%

DATA SUBJECT TO CHANGE WITHOUT NOTICE.

Indoor Unit (Body) **XMHS1272**

Control PCB	
Part No.	CB-XMHS1272
Controls	Microprocessor
Control Circuit Fuse	250V 3A

Remote Control Unit	RCS-7MHVPSW4U
----------------------------	---------------

Fan	
Type	Turbo
Q'ty ... Dia. and Length	inch (mm) 1 ... D12-5/8 / L5-3/4 (D322/L147)

Fan Motor	
Type	DC Motor
Model ... Q'ty	SIC-69FV-D866-1 ... 1
No. of Poles	8
Rough Measure RPM (Cool / Heat)	470 / 520
Rating	Voltage / Nominal Output DC280V / 23W
Coil Resistance (Ambient Temp. 68 °F (20 °C))	Ohm -
Safety Device	Type Thermal Fuse
	Over- Current Protection Yes
	Over- Heat Protection Yes
Run Capacitor	Micro F -
	VAC -

Drain Pump	
Model ... Q'ty	PLD-12230ST-1 ... 1
Rating	Voltage, Hz AC208 to 240V, 60Hz
	Input W 10.8
Coil Resistance (Ambient Temp. 68 °F (20 °C))	Ohm 333 +/- 10%
Safety Device	Type Thermal Fuse
	Open °F (°C) 293 (145)

Heat Exchanger Coil	
Coil	Aluminum Plate Fin / Copper Tube
Rows	2
Fins per inch	18.1
Face Area	ft ² (m ²) 2.94 (0.273)

DATA SUBJECT TO CHANGE WITHOUT NOTICE.

Indoor Unit (Panel) **PNR-XS1872**

Flap Motor	
Type	Stepping Motor
Model ... Q'ty	MP24ZN-12V ... 2
Rating	DC 12V
Coil Resistance (Ambient Temp. 77 °F (25 °C))	Ohm Each Pair of Terminal : 380 +/- 7%

DATA SUBJECT TO CHANGE WITHOUT NOTICE.

Indoor Unit (Body) **XHS1872**

Control PCB	
Part No.	CB-XHS1872
Controls	Microprocessor
Control Circuit Fuse	250V 3A

Remote Control Unit	RCS-7MHVPSW4U
----------------------------	---------------

Fan	
Type	Turbo
Q'ty ... Dia. and Length	inch (mm) 1 ... D12-5/8 / L5-3/4 (D322/L147)

Fan Motor	
Type	DC Motor
Model ... Q'ty	SIC-72FV-D866-1B ... 1
No. of Poles	8
Rough Measure RPM (Cool / Heat)	650 / 720
Rating	Voltage / Nominal Output DC340V / 20W
Coil Resistance (Ambient Temp. 68 °F (20 °C))	Ohm -
Safety Device	Internal Controller
Type	Over- Current Protection
	Over- Heat Protection
Run Capacitor	Micro F -
	VAC -

Drain Pump	
Model ... Q'ty	PLD-12230ST-1 ... 1
Rating	Voltage, Hz AC208 to 240V, 60Hz
	Input W 10.8
Coil Resistance (Ambient Temp. 68 °F (20 °C))	Ohm 333 +/- 10%
Safety Device	Thermal Fuse
Type	Open °F (°C) 293 (145)

Heat Exchanger Coil	
Coil	Aluminum Plate Fin / Copper Tube
Rows	2
Fins per inch	18.1
Face Area	ft ² (m ²) 2.94 (0.273)

DATA SUBJECT TO CHANGE WITHOUT NOTICE.

Indoor Unit (Panel) **PNR-XS1872**

Flap Motor	
Type	Stepping Motor
Model ... Q'ty	MP24ZN-12V ... 2
Rating	DC 12V
Coil Resistance (Ambient Temp. 77 °F (25 °C))	Ohm Each Pair of Terminal : 380 +/- 7%

DATA SUBJECT TO CHANGE WITHOUT NOTICE.

2-3. Other Component Specifications

Indoor Unit **XMHS0972 & PNR-XS1872**
XMHS1272 & PNR-XS1872
XHS1872 & PNR-XS1872

• **Indoor air temp sensor**
(Model:KTEC-35-S98)

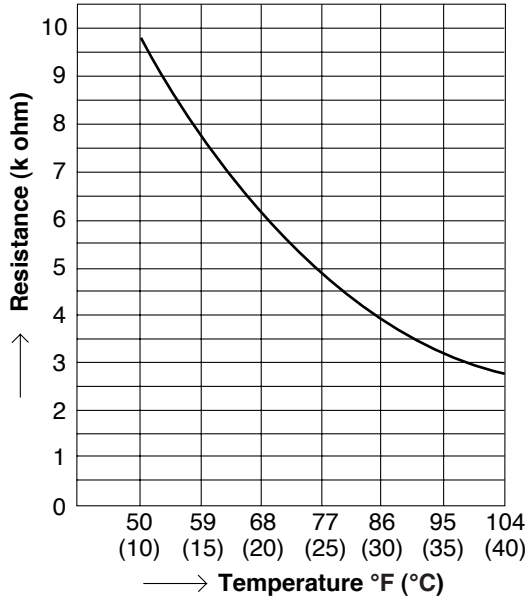

• **Indoor heat exchanger sensor**
(Model:PT2M-51H-S3)

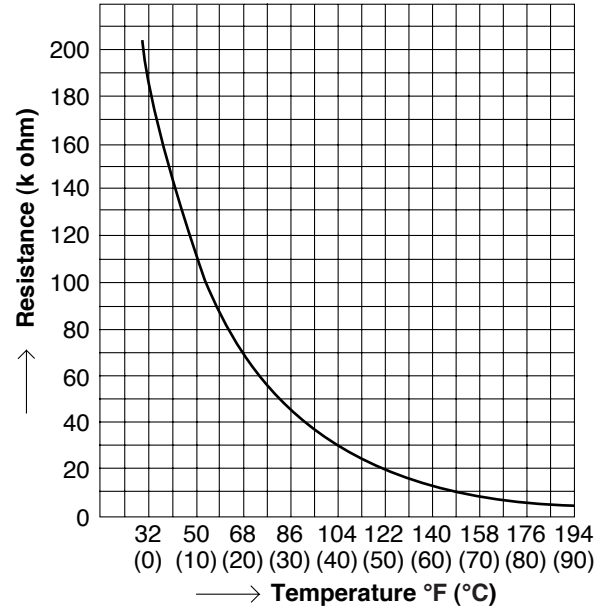

3. DIMENSIONAL DATA

Indoor Unit **XMHS0972 & PNR-XS1872**
XMHS1272 & PNR-XS1872
XHS1872 & PNR-XS1872

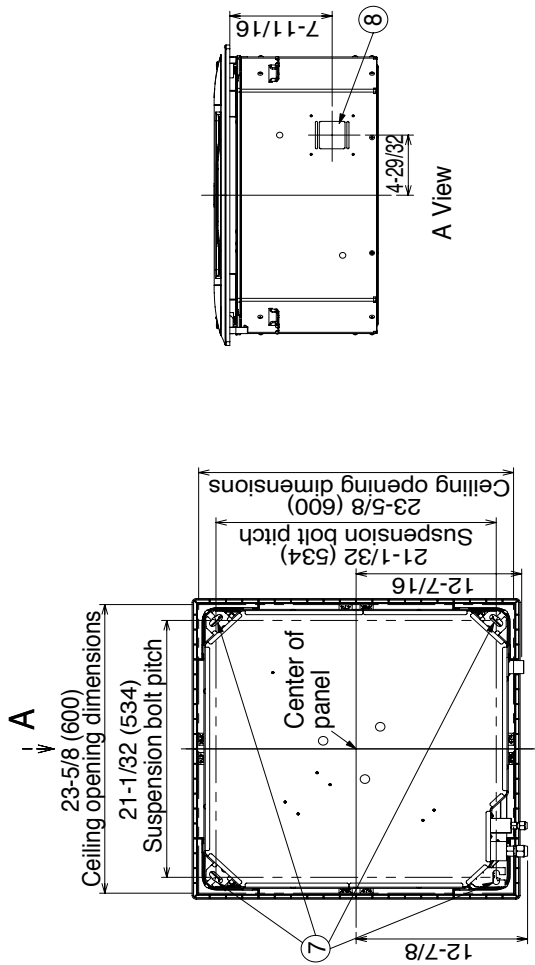

①	Air intake
②	Discharge outlet
③	Refrigerant tubing (liquid tube) dia. 1/4" (flared)
④	Refrigerant tubing (gas tube) dia. 1/2" (flared)
⑤	Drain tube connection port VP20 (outer dia. 1")
⑥	Power supply port
⑦	Suspension bolt hole (4 - 1/2" x 1-1/8" hole)
⑧	Fresh air intake duct connection port (dia. 3-7/8")

A View

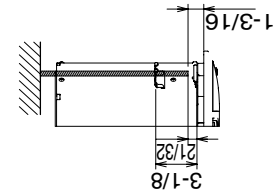
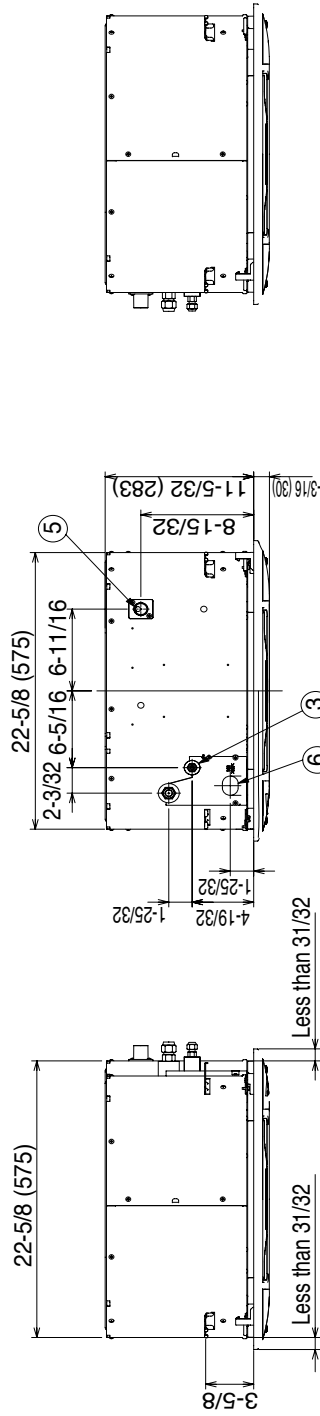

The length of the suspension bolts should be selected so that there is a gap of 1-3/16" or the ceiling (21/32" or more below the lower surface of the main unit), as shown in the figure at right. If the suspension bolts is too long, it will contact the ceiling panel and the unit cannot be installed.

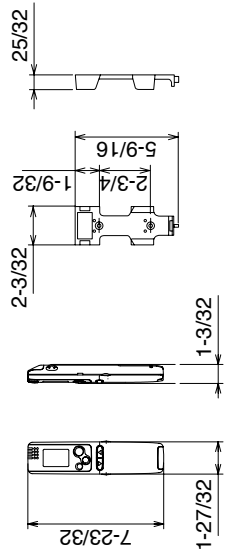
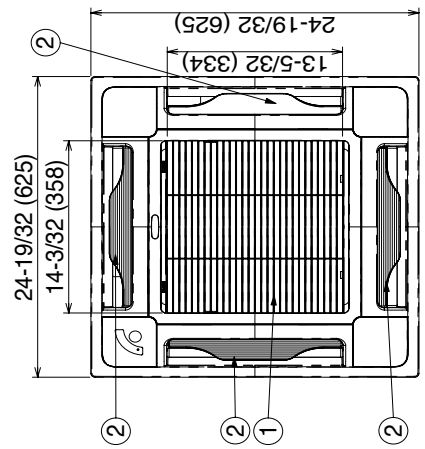

Unit : inch (mm)

4. REFRIGERANT FLOW DIAGRAM

4-1. Refrigerant Flow Diagram

Indoor Unit **XMHS0972 & PNR-XS1872**
XMHS1272 & PNR-XS1872

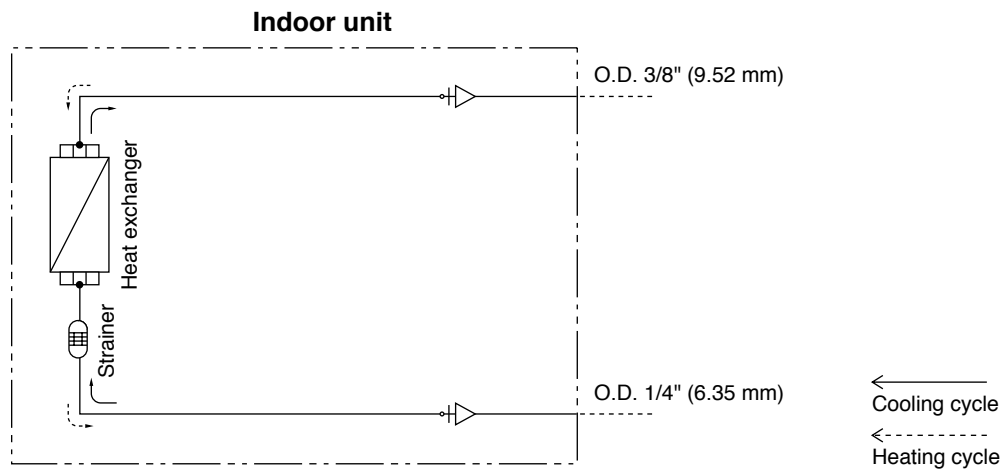

Indoor Unit **XHS1872 & PNR-XS1872**

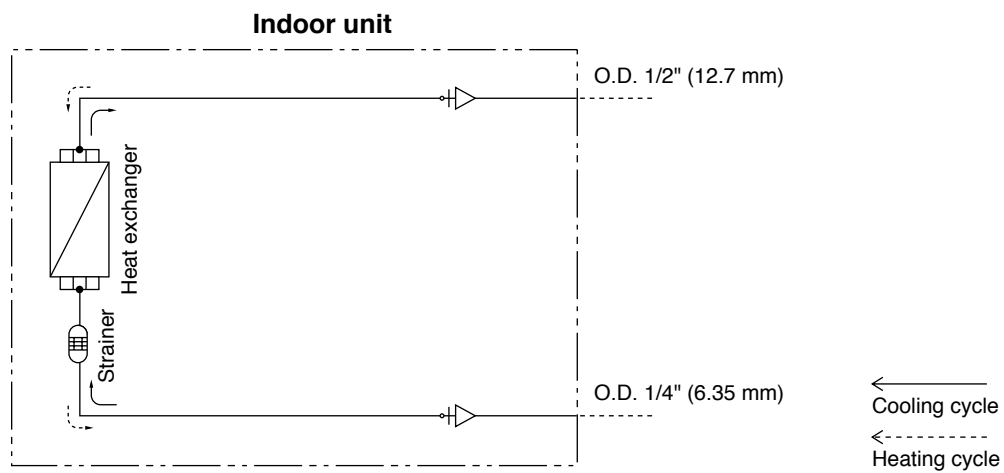

5. ELECTRICAL DATA

5-1. Electric Wiring Diagrams

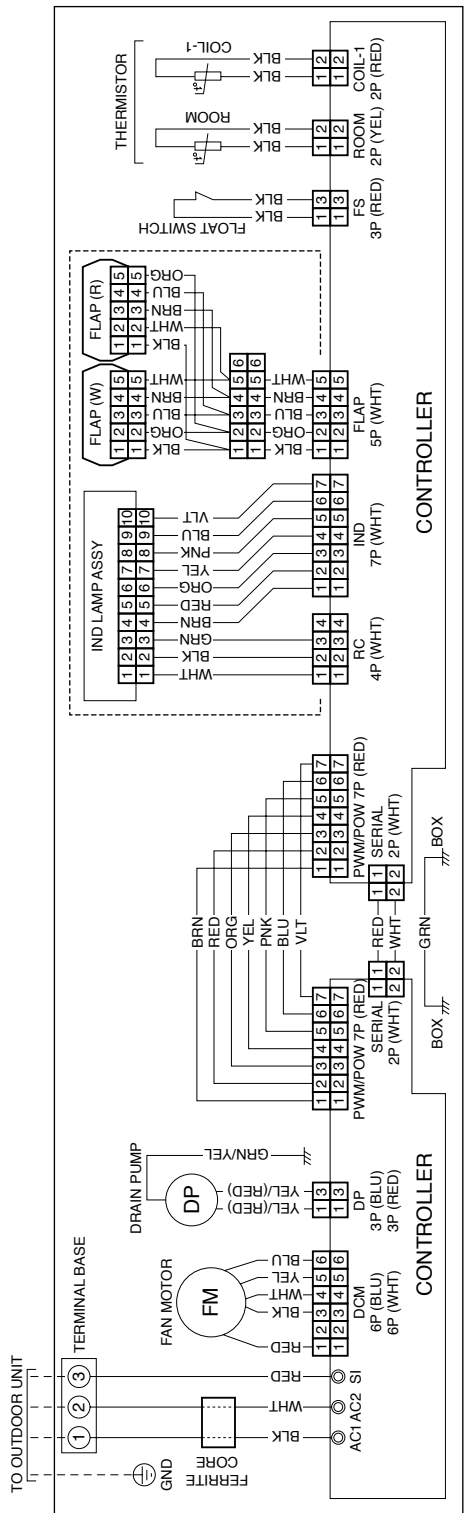

Indoor Unit **XMHS0972 & PNR-XS1872**
 XMHS1272 & PNR-XS1872
 XHS1872 & PNR-XS1872



8FA2-5250-46900-2

6. MAINTENANCE

6-1. Disassembly Procedure

 Warning	<ul style="list-style-type: none">● To avoid electrical shock hazard, be sure to disconnect power before attempting to disassemble the unit.● When a footstool, etc. is used for disassembling the indoor unit, be careful not to fall down. If you fall down, you might be injured seriously.	
--	---	---

6-1-1. Remove the air intake grill.

- (1) Slide the 2 latches each to the corresponding arrow direction. (Fig. 1 and Fig. 2)
Open downward the air intake grill located on the latch side.
- (2) Undo the air intake grill drop preventive hook. (Fig. 3)
Undo the 2 hinges for the grill and remove the air intake grill.

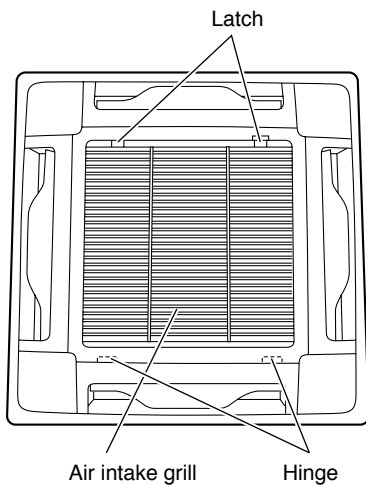

Fig.1

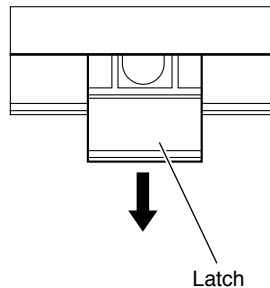

Fig.2

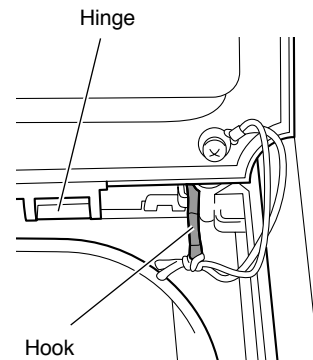

Fig.3

6-1-2. Disconnect the connectors in the control box.

- (1) Remove the 2 screws and remove the control box cover. (Fig. 4)
- (2) Disconnect the connectors CN04 (FLAP 5P), CN12 (RC 4P) and CN13 (IND 7P). (Fig. 5)

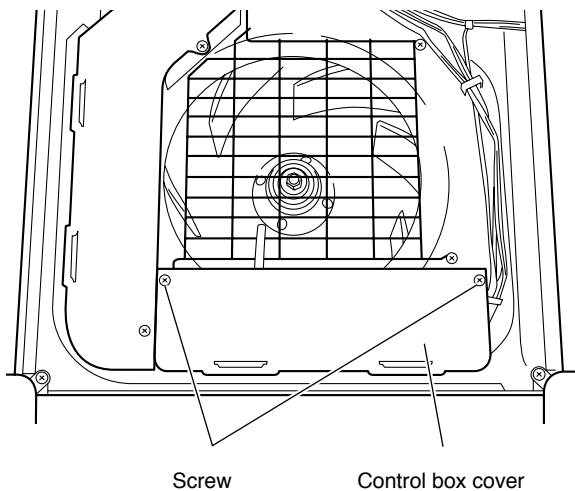

Fig.4

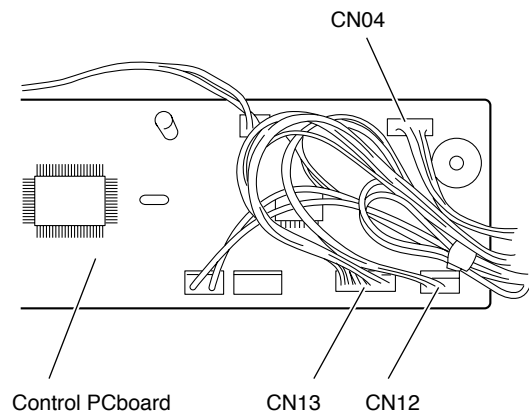

Fig.5

6-1-3. Remove the ceiling panel.

- (1) Open the clamp (4 locations) and remove the 2 lead wires from the clamps. (Fig. 6)
- (2) Remove the 4 screws fixing the corner cover (at 3 locations) and indicator cover (at 1 location). (Fig. 6)
- (3) Press the center 1 of the cover and remove the cover with the section 2 pulled down. (Fig. 7)
- (4) Remove the strap (3 locations) from the hook on the ceiling panel. (Fig. 8)

NOTE There is no strap on the indicator cover.

- (5) Remove the bolt (4 locations) with a washer and remove the ceiling panel. (Fig. 9)

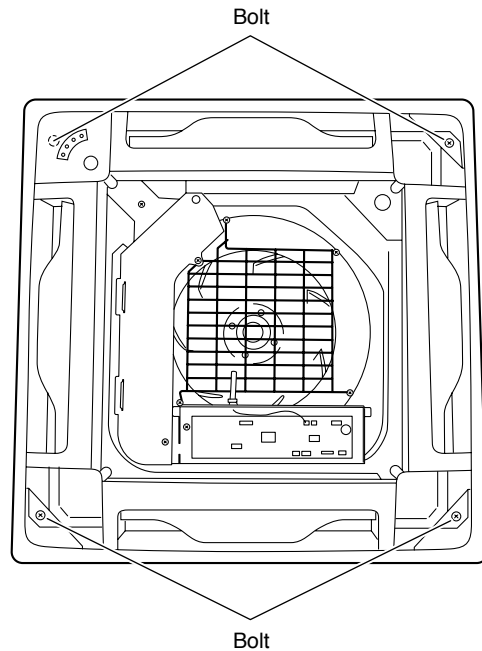
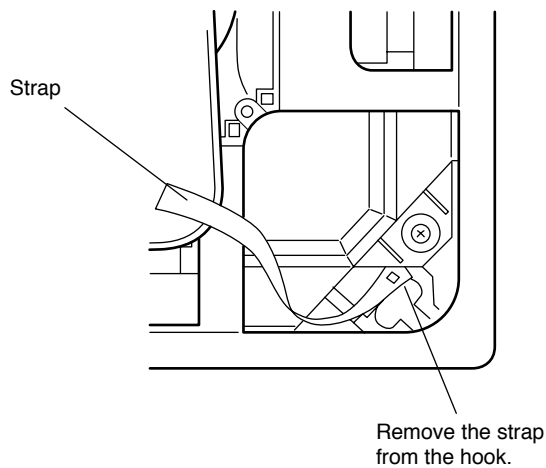
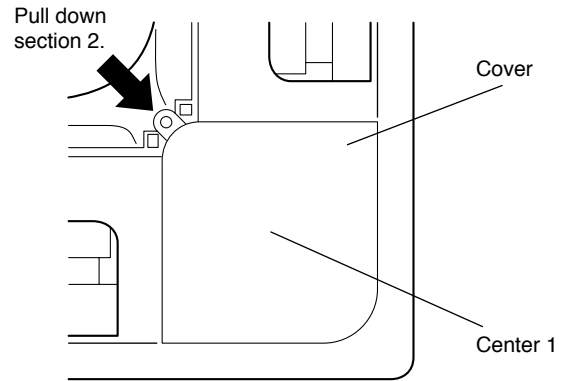
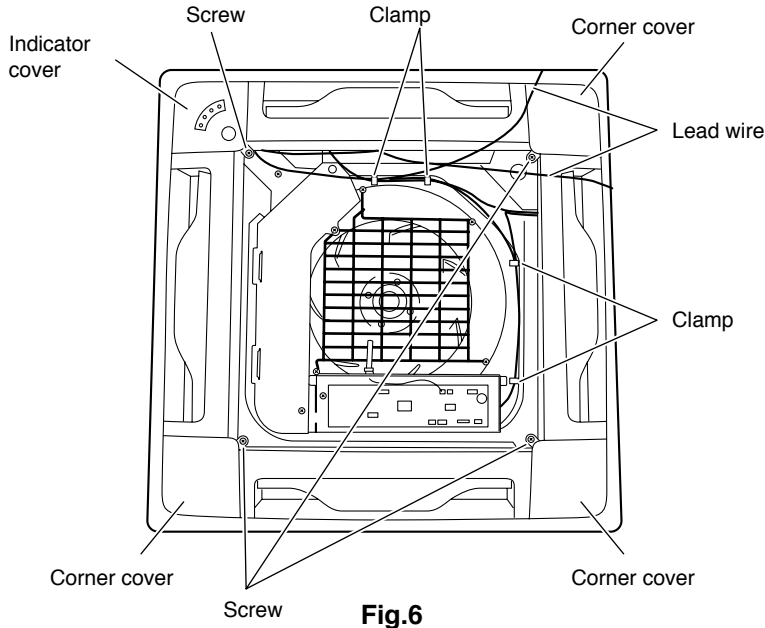

6-1-4. Remove the indoor air temperature sensor.

- (1) Disconnect the connector CN08 (ROOM 2P) in the control box and remove the indoor air temperature sensor. (Fig. 10)

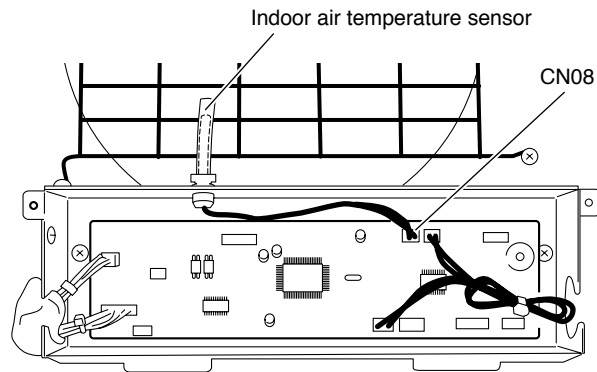

Fig.10

6-1-5. Remove the power box and control box.

- (1) Remove a screw and remove the terminal cover. (Fig. 11)
- (2) Remove the 2 screws and remove the power box cover. (Fig. 11)
- (3) Disconnect the power lines (No. 1 and No. 2) / signal line (No. 3) and ground cable from the terminals in the power box. (Fig. 12)

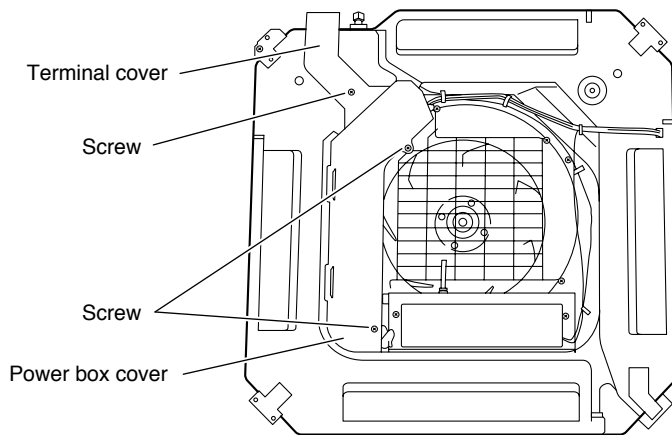

Fig.11

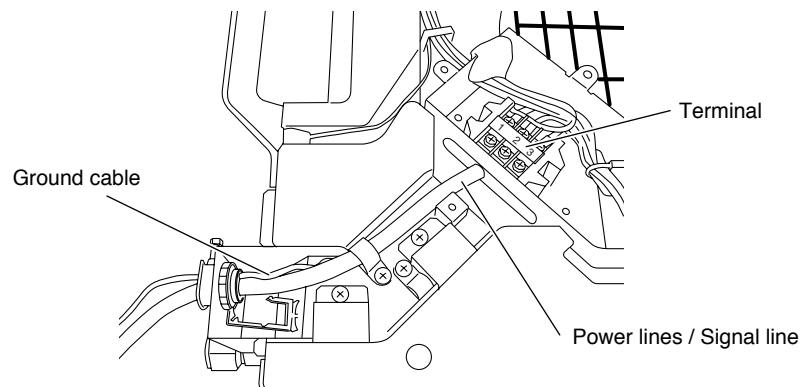

Fig.12

- (4) Disconnect the connector CN07 (DP 2P) in the power box. (Fig. 13)
Remove a screw and disconnect the ground cable. (Fig. 13)
- (5) Disconnect the connector CN03 (DCM 6P) in the power box. (Fig. 14)
- (6) Remove the 4 screws and remove the power box. (Fig. 14)
- (7) Disconnect the connectors CN06 (FS 3P) and CN09 (COIL-1 2P) in the control box. (Fig. 15)
- (8) Remove the 2 screws and remove the control box. (Fig. 15)

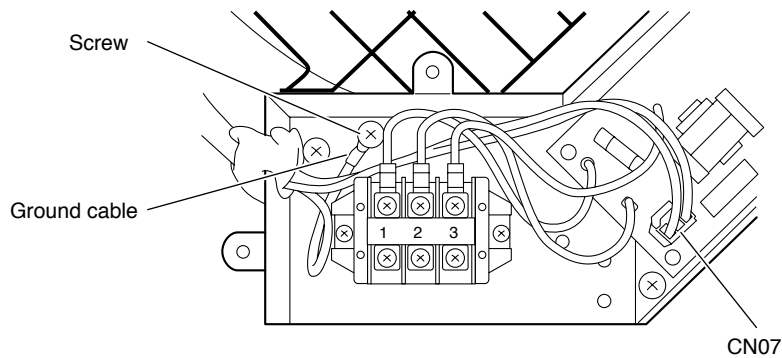

Fig.13

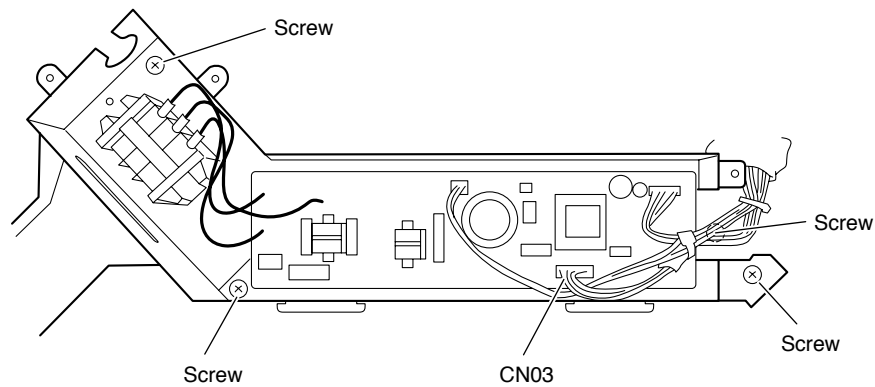

Fig.14

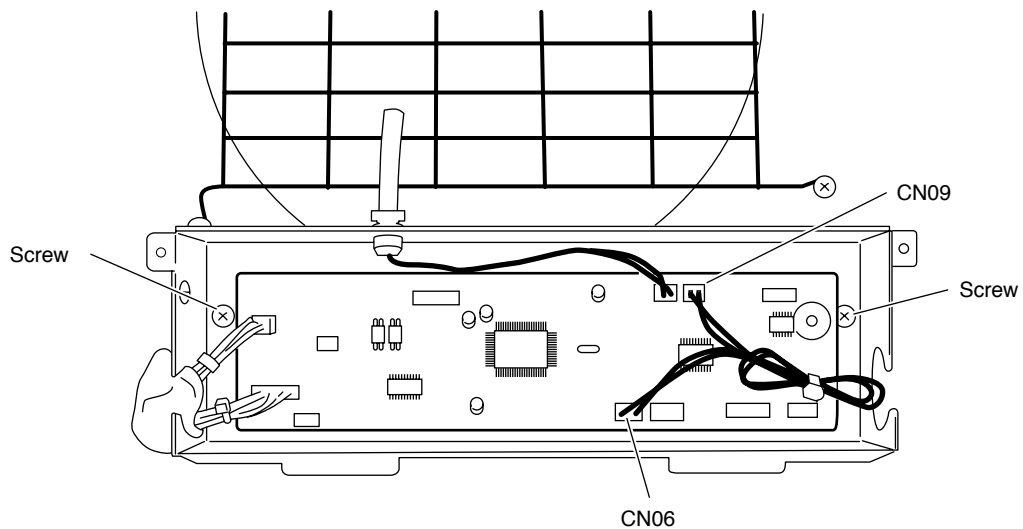

Fig.15

NOTE For the removal of the following components, perform any work after removing the indoor unit (main body) from the ceiling.

- Main body lower section
- Heat exchanger sensor
- Drain pump
- Float switch
- Turbo fan
- Fan motor
- Heat exchanger

1. Perform the work after draining the water to prevent the water leakage from the drain pan.
 - Put a bucket, etc., under the drain cap and remove the drain cap to drain the water. (Fig. 16)
2. Refer to the installation instructions for recovery of refrigerant or removal of the power cable or tubing.

6-1-6. Remove the main body lower section.

- (1) Remove the 4 screws. (Fig. 16)
- (2) Remove the 2 screws. (Fig. 17)
- (3) Disconnect the connector CN03 (DCM 6P) in the power box. (Fig. 18)
- (4) Lift the main body lower section and remove it from the main body upper section.

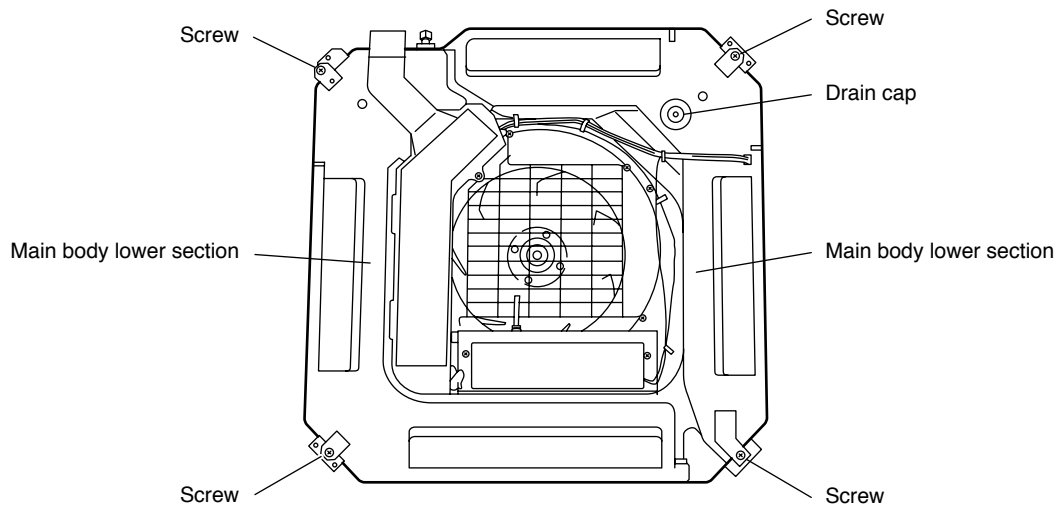

Fig.16

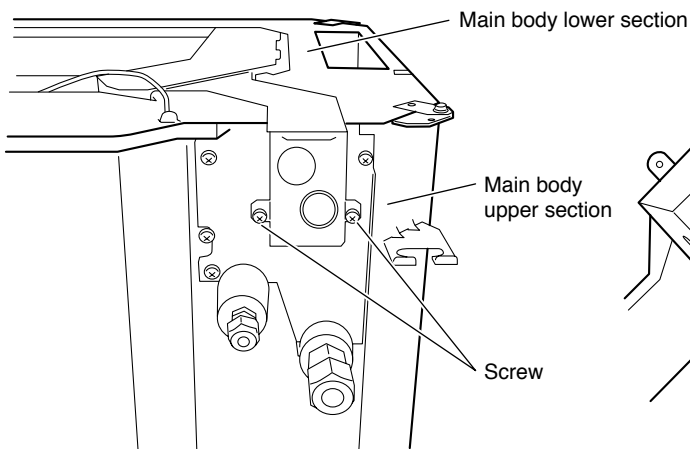

Fig.17

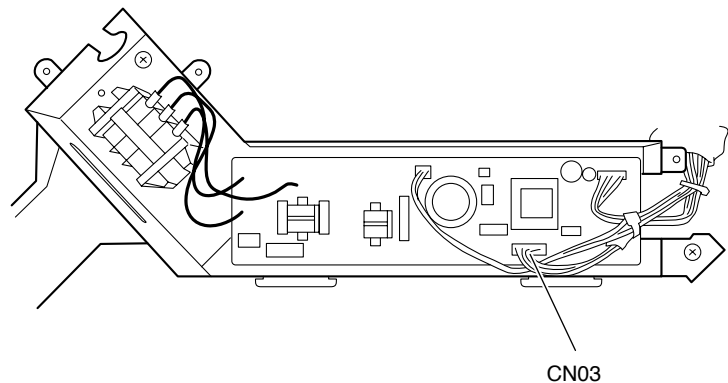

Fig.18

6-1-7. Remove the heat exchanger sensor.

- (1) Remove the heat exchanger sensor from the sensor holder. (Fig. 19)

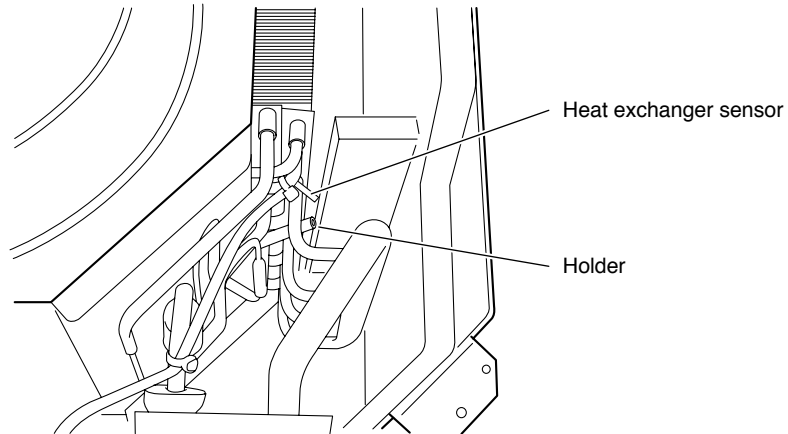

Fig.19

6-1-8. Remove the drain pump and float switch.

- (1) Remove the 2 screws (Fig. 20)
- (2) Loosen the clamp and disconnect the drain hose from the drain pump. (Fig. 20)
- (3) Remove the drain pump from the main body upper section. (Fig. 20)
- (4) Remove a nut and remove the float switch. (Fig. 21)

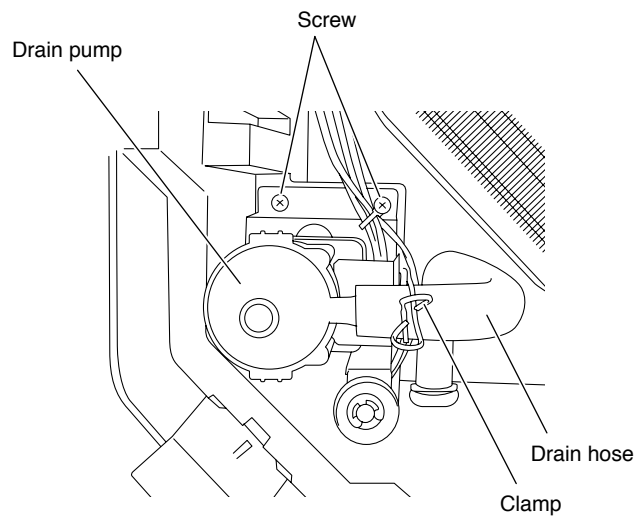

Fig.20

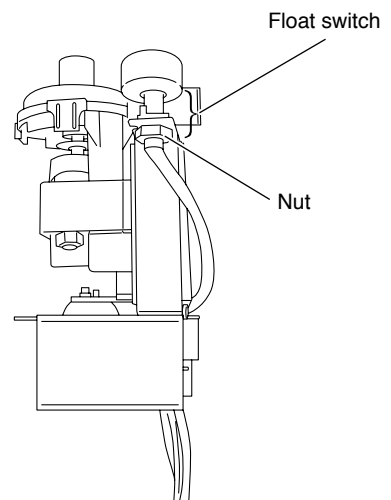

Fig.21

6-1-9. Remove the turbo fan and fan motor.

- (1) Remove a nut and remove the turbo fan. (Fig. 22)
- (2) Remove the 2 screws and 3 nuts, and remove the fan motor. (Fig. 23)

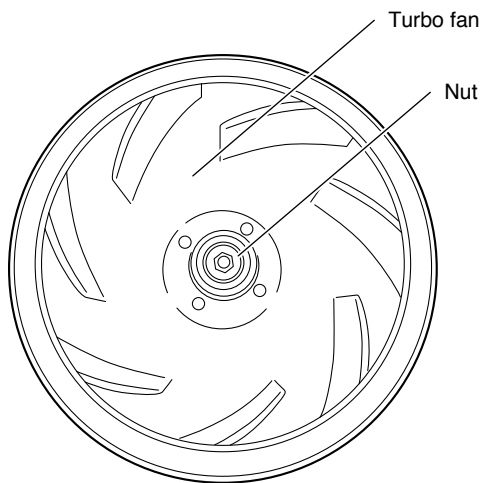

Fig.22

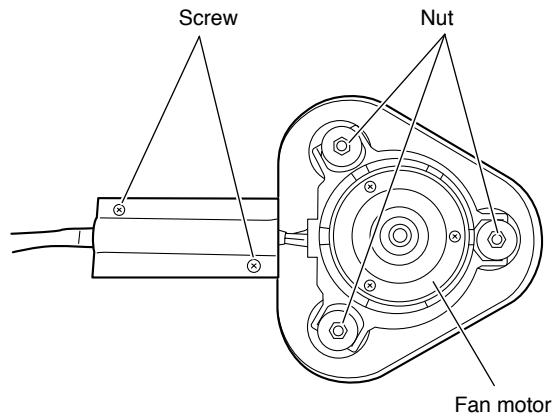

Fig.23

6-1-10. Remove the heat exchanger.

- (1) Remove the 3 screws. (Fig. 24)
- (2) Remove the 3 screws. (Fig. 25)
- (3) Remove the heat exchanger from the main body upper section with the heat exchanger lifted.

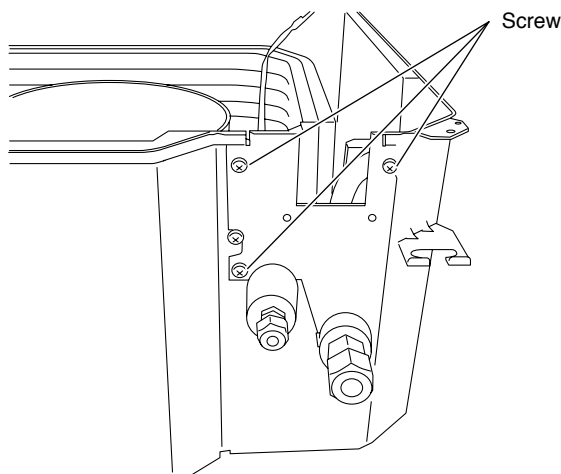

Fig.24

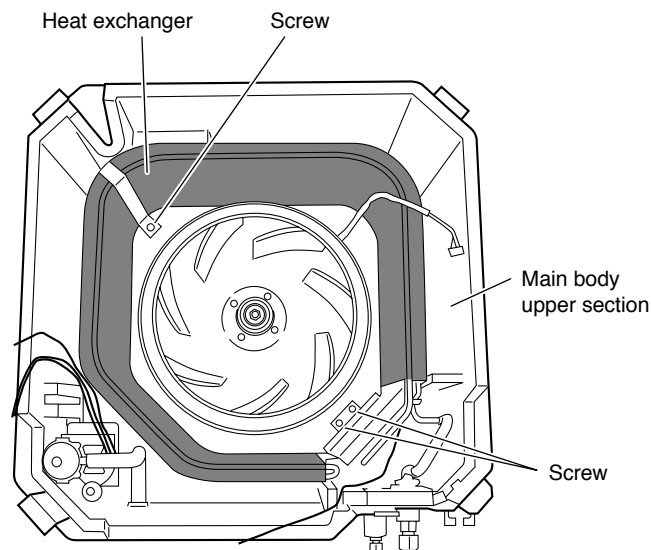

Fig.25

7. FUNCTIONS

7-1. Operation Functions

Emergency operation

Emergency operation is available when the remote controller malfunctions, has been lost, or otherwise cannot be used.

To operate the system, press the OPERATION button, which is also used as the receiver, below the unit display. Each time this button is pressed, the OPERATION lamp changes color to indicate the type of operation. Select the desired type of operation.

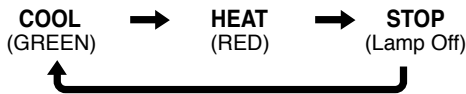

- The set temperature is 4°F(2°C) below the detected room temperature in the case of cooling operation, and 4°F(2°C) above the room temperature in the case of heating operation. The flap and fan speed settings are AUTO.

AUTO cooling/heating operation

Selecting the operation mode

- When AUTO mode is selected, the microprocessor calculates the difference between the set temperature and the room temperature, and automatically switches to Cooling or Heating mode.

Room temp. \geq Set temp. \rightarrow COOL
 Room temp. $<$ Set temp. \rightarrow HEAT

- As shown by the example in the figure below, with AUTO cooling/heating operation, the mode changes between Heating and Cooling mode according to changes in the relationship between the current room temperature and the set temperature.

Example

Example of operation in AUTO mode with the set room temperature at 74°F(23°C).

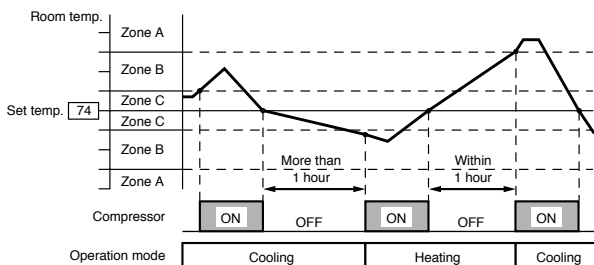

SENSOR DRY

During DRY operation, the system adjusts the room temperature and fan speed according to the conditions in the room, in order to maintain a comfortable room environment.

SENSOR DRY operation

- DRY operation is as shown in the figure below.

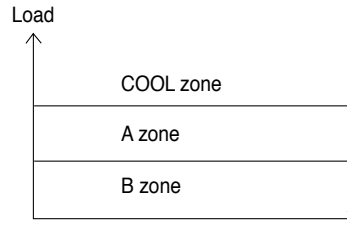

Conditions are monitored at all times when the room temperature is below 59°F(15°C).

DRY A

The compressor operation frequency varies.
 The indoor fan operates with 1/f fluctuation.

DRY B

The compressor operates at a low operating frequency.
 The indoor fan operates with 1/f fluctuation.

Monitor

- Monitoring operation takes place when the room temperature is below 59°F(15°C), or more than 5°F(3°C) below the set temperature.
- When the monitoring range is entered, the compressor stops, and the indoor fan operates with 1/f fluctuation.

PAM- α control

- In order to further improve inverter performance, control is switched between PWM control at low operation speeds, and PAM control at high operation speeds, making the most effective use of power.

■ HIGH POWER

This function acts to raise the power but keeps the AC system in the same operating mode. This function is set with the HIGH POWER button on the remote controller.

(It can be set regardless of the temperature and fan speed settings.)

● HIGH POWER operation from remote controller

The unit operates at maximum output for 30 minutes, regardless of the desired temperature. The fan speed is 1 step above "High."

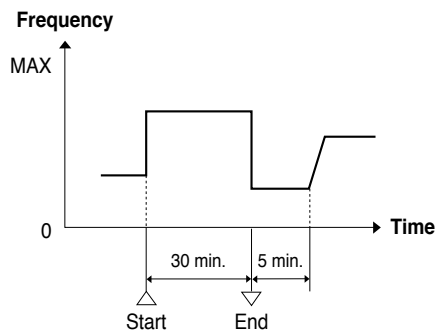

NOTE

- When HIGH POWER operation ends, the unit operates at low Hz for 5 minutes, regardless of the thermostat OFF conditions.
- When in DRY mode, operation is in the cooling zone.

■ Lamp colors

OPERATION lamp

HEAT operation	Red
DRY operation	Orange
COOL operation	Green
FAN operation	Green
DEFROSTING operation	Red and Orange alternately

OPERATION lamp Green

TIMER lamp Green

HIGH POWER lamp Green

■ Timer backup

- Operation stops if there are no operator controls for 25 hours or longer after unit operation switched from OFF to ON by use of ON timer operation.

■ NIGHT SETBACK

- When NIGHT SETBACK operation is set, the temperature and fan speed settings will be adjusted automatically to allow comfortable sleep.
- When NIGHT SETBACK operation is set, "☺ mark" appears on the remote controller. The main unit display lamp also becomes dimmer.

● COOL and DRY modes

When the night setback mode is selected, the air conditioner automatically raises the temperature setting $2^{\circ}\text{F}(1^{\circ}\text{C})$ when 30 minutes have passed after the selection was made, and then another $2^{\circ}\text{F}(1^{\circ}\text{C})$ after another 30 minutes have passed, regardless of the indoor temperature when night setback was selected. This enables you to save energy without sacrificing comfort. This function is convenient when gentle cooling is needed.

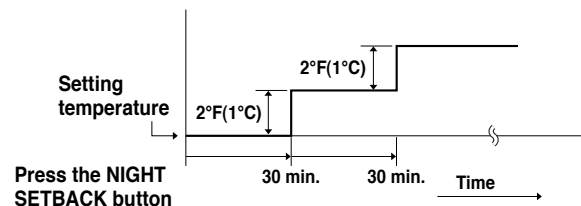

Press the NIGHT SETBACK button

● HEAT mode

When the night setback mode is selected, the air conditioner automatically lowers the temperature setting $4^{\circ}\text{F}(2^{\circ}\text{C})$ when 30 minutes have passed after the selection was made, and then another $4^{\circ}\text{F}(2^{\circ}\text{C})$ after another 30 minutes have passed, regardless of the indoor temperature when night setback was selected. This enables you to save energy without sacrificing comfort. This function is convenient when gentle heating is needed.

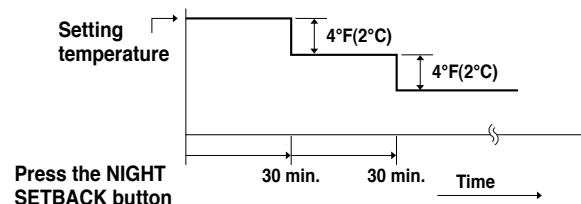

Press the NIGHT SETBACK button

7-2. Protective Functions

Overload prevention during heating

During HEAT operation, the temperature of the indoor heat exchanger is used to control the frequency and lessen the load on the compressor before the protective device is activated.

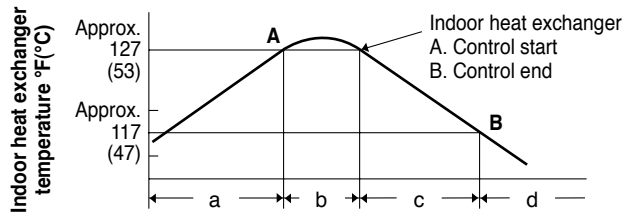

- Area: Automatic capacity control
- When Point A has been exceeded, the operation frequency is reduced by a certain proportion.
- Area: Frequency increase is prohibited.
- At Point B and below, overload prevention is ended and control is the same as in the a area.

Freeze prevention

During COOL or DRY operation, freezing is detected and operation is stopped when the temperature of the indoor heat exchanger matches the conditions below.

- Freeze-prevention operation is engaged when the temperature of the indoor heat exchanger is below 43°F(6°C).
- Restart after freeze-prevention operation occurs when the temperature of the indoor heat exchanger reaches 46°F(8°C) or above.

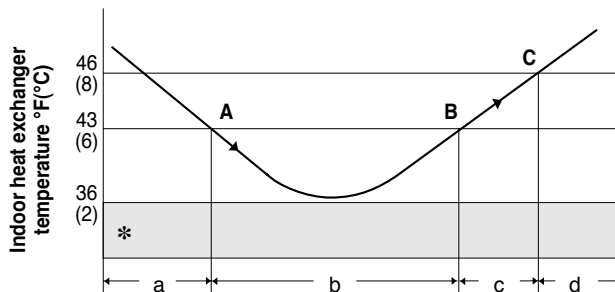

- Area: Automatic capacity control
- When the temperature drops below Point A, the operation frequency is reduced by a certain proportion.
- Area: Frequency increase is prohibited.
- When the temperature reaches Point C or above, freezing prevention is ended and control is the same as in the a area.

* When the temperature drops to below 36°F(2°C) (continuously for 2 minutes or longer), the compressor stops. Once the freeze condition is detected, the air conditioner will work less than the maximum frequency until it is turned off.

Cold-air prevention during heating

During heating, the fan speed is set to "LL" (very low) or stopped. As the temperature of the indoor heat exchanger rises, the fan speed is changed to the set speed.

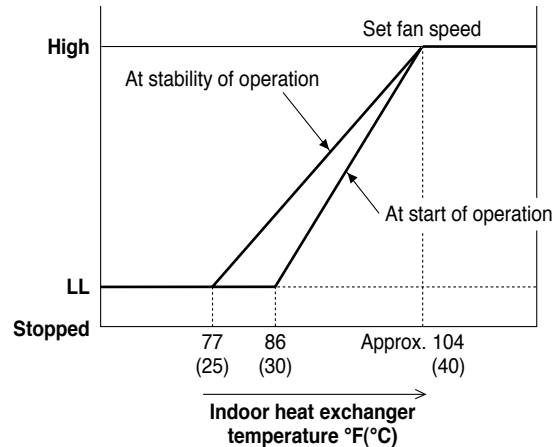

NOTE

- The fan speed is forcibly changed to "LL" beginning 30 seconds after the thermostat turns OFF.
- At stability of operation refers to operation when the room temperature has approached the set temperature.
- When HEAT operation starts, the indoor fan is stopped until the temperature of the indoor heat exchanger reaches 68°F(20°C) or higher, or until the room temperature reaches 59°F(15°C) or higher.

8. TROUBLESHOOTING

8-1. Precautions before Performing Inspection or Repair

- After checking the self-diagnostics monitor, turn the power OFF before starting inspection or repair.
 - High-capacity electrolytic capacitors are used inside the outdoor unit controller (inverter). They retain an electrical charge (charging voltage DC 310V) even after the power is turned OFF, and some time is required for the charge to dissipate. Be careful not to touch any electrified parts before the controller LED (red) turns OFF.
- If the outdoor controller is normal, approximately 30 seconds will be required for the charge to dissipate. However, allow at least 5 minutes for the charge to dissipate if there is thought to be any trouble with the outdoor controller.

8-2. Method of Self-Diagnostics

Follow the procedure below to perform detailed trouble diagnostics.

NOTE

- 1: If the operation lamp blinks every 0.5 seconds immediately when the power is turned ON, there is an external ROM (OTP data) failure on the indoor circuit board, or a ROM socket insertion problem, or the ROM has not been installed.
- 2: The failure mode is stored in memory even when the power is not ON. Follow the procedure below to perform diagnostics.

PROCEDURE

After turning on power to the air conditioner, use the remote controller and follow the steps below to execute self-diagnostics.

- Step 1: Press and hold the remote controller HIGH POWER button and 1 HR TIMER button. Then, press and hold the ACL (reset) button with a pointed object such as the tip of a pen. After 5 seconds, release ACL button first, then release HIGH POWER and 1 HR TIMER buttons, "oP-1" (test run) appears, blinking in the remote controller clock display area.
- Step 2: Next, press the 1 HR TIMER button once to change the display from "oP-1" to "oP-3" (self-diagnostics). (The display continues to blink.)
- Step 3: Finally press the ON/OFF button to engage self-diagnostics mode.

- The self-diagnostics function utilizes the 3 indicator lamps on the main unit, in combinations of ON lamps, blinking lamps, and OFF lamps, to report the existence of sensor trouble or a protective operation. (The lamps blink or remain ON for 5 seconds, then turn OFF for 2 seconds.) Self-diagnostics is completed when the buzzer sounds 3 short beeps.
- A maximum of 3 self-diagnostics reports are displayed, for 5 seconds each, beginning with the most recent report. Following this display the lamps turn OFF. In order to view the self-diagnostics results again, press the ON/OFF button again.
- The 3 lamps remain OFF if no trouble has occurred.

<IMPORTANT> After self-diagnostics is completed, be sure to press the ACL (reset) button to return to normal mode. The air conditioner will not operate if this is not done.

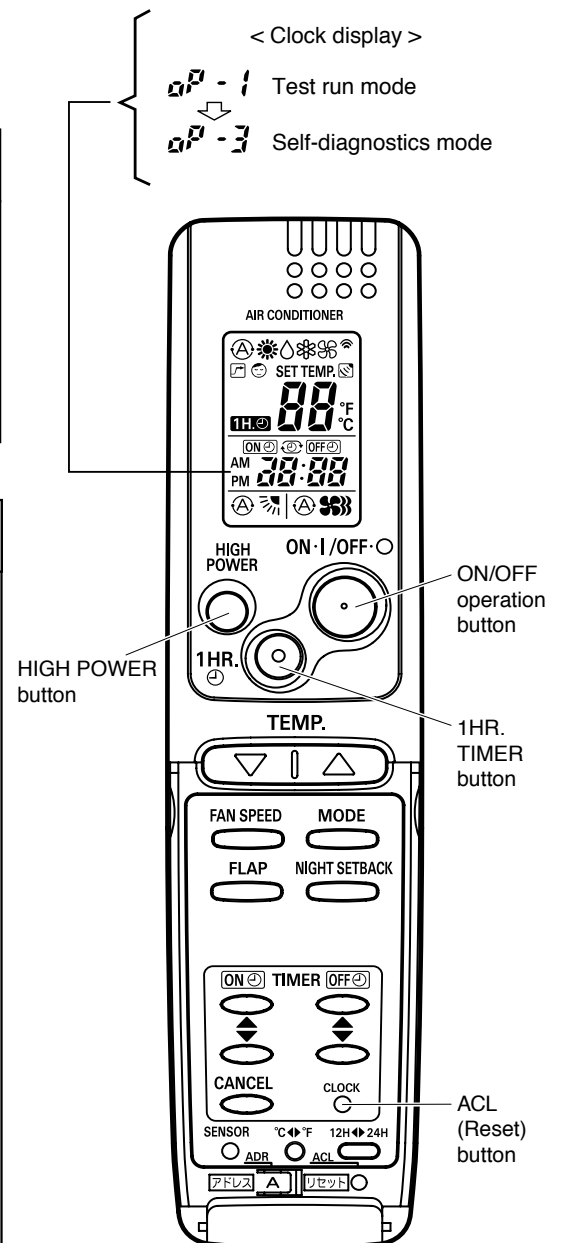

(1) Self-diagnostics Lamps

INDOOR UNIT

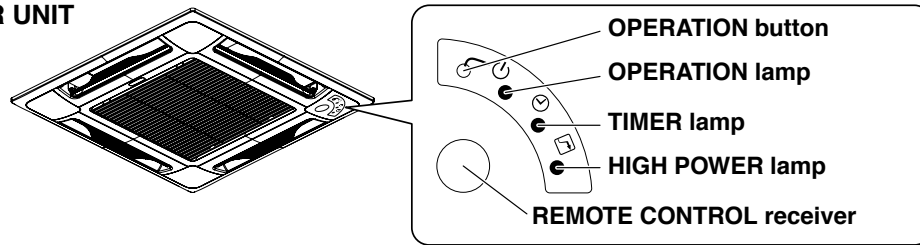

• Since the indications cover various units, the corresponding parts listed below may not be present in some models.

Indication on indoor unit				× OFF	● Blinking	☀ ON (Illuminated)	
OPERATION ☰	Timer ⌚	HIGH POWER ⚡	Code	Diagnostics items	Diagnostics contents		
●	×	×	S01	Room temperature sensor failure	(1) Sensor open circuit or short circuit		
×	●	×	S02	Indoor heat exchanger sensor failure	(2) Contact failure at connector or open circuit at terminal crimping location (3) Indoor/outdoor PCboard failure		
×	×	●	S04	Compressor temperature sensor failure	(1) Sensor open circuit or short circuit		
●	×	●	S05	Outdoor heat exchanger sensor failure	(2) Contact failure at connector or open circuit at terminal crimping location (3) Outdoor PCboard failure		
×	●	●	S06	Outdoor air temperature sensor failure			
●	●	●	S07	Outdoor electrical current detection failure	Outdoor PCboard failure		
☀	×	×	E01	Indoor/outdoor communications failure (serial communications)	(1) Mis-wiring (2) AC power failure (3) Blown fuse (4) Power Relay failure (5) Indoor or outdoor PCboard failure (6) Outdoor Fan Motor failure (7) Reactor failure (8) High-Pressure Switch failure (9) Overload Relay failure (10) Magnetic Coil failure * See detailed flowchart in this section.		
×	☀	×	E02	• HIC circuit failure • Power Tr (transistor) circuit failure	(1) HIC or power Tr failure (2) Outdoor fan does not turn. (3) Instantaneous power outage (4) Service valve not opened. (5) Outdoor fan blocked. (6) Continuous overload operation (7) Compressor failure (8) Outdoor PCboard failure		
☀	☀	×	E03	Outdoor unit external ROM (OTP data) failure	(1) External ROM data failure (2) Outdoor PCboard failure		
×	×	☀	E04	Peak current cut-off	(1) Instantaneous power outage (2) HIC or power transistor failure (3) Outdoor PCboard failure		
☀	×	☀	E05	• PAM circuit failure • Active circuit failure	(1) Outdoor PCboard failure (2) Outdoor power supply voltage failure		
×	☀	☀	E06	Compressor discharge overheat prevention activated.	(1) Electric expansion valve failure (2) Capillaries choked (3) Shortage of refrigerant (4) Continuous overload operation (5) Outdoor fan does not rotate (6) Outdoor PCboard failure		
☀	☀	☀	E07	Indoor fan operating failure	(1) Fan motor failure (2) Contact failure at connector (3) Indoor PCboard failure		
☀	●	●	E08	• 4-way valve switching failure • Indoor zero-cross failure	(1) 4-way valve failure (heat pump model only) (2) Outdoor PCboard failure		
●	☀	●	E09	No-refrigerant protection	(1) Service valve not opened. (2) Shortage of refrigerant		
☀	☀	●	E10	DC compressor drive circuit failure	(1) Open phase (2) Outdoor PCboard failure		
●	●	☀	E11	Outdoor fan operating failure	(1) Fan motor failure (2) Contact failure at connector (3) Outdoor PCboard failure		
☀	●	☀	E12	• Outdoor system communications failure • OLR operation • Outdoor power supply open phase • Outdoor coil freezing	(1) Mis-wiring (2) Blown fuse (3) Power Relay failure (4) Outdoor PCboard failure (5) Compressor failure * See detailed flowchart in this section.		
●	☀	☀	E13	Freeze-prevention operation activated.	(1) Indoor fan system failure (2) Shortage of refrigerant (3) Low-temperature operation		
TIMER LAMP ⌚ BLINKING (3 SEC. INTERVAL)			FLOAT SWICHTH (FS) IS ACTIVATED.		(1) DRAIN PUMP FAILURE (2) FS FAILURE (3) CHOKED DRAIN HOSE		

(2) If the self-diagnostics function fails to operate

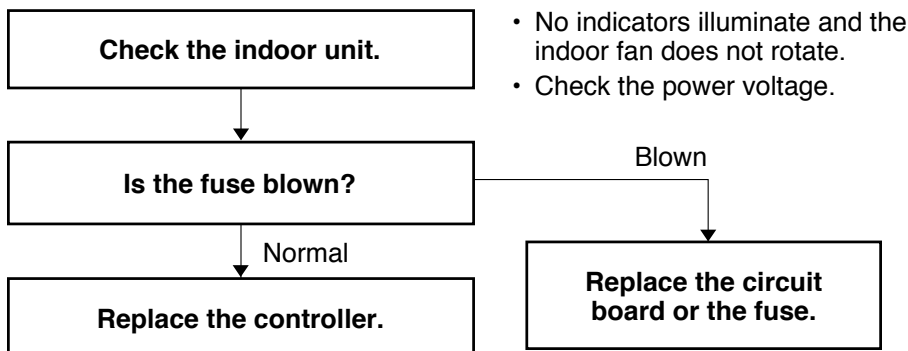

8-3. Checking the Indoor and Outdoor Units

(1) Checking the indoor unit

No.	Control	Check items (unit operation)
1	Use the remote controller to operate the unit in "TEST run" mode. To determine whether the mode is currently in "TEST run" mode, check the 3 indicator lamps on the unit. If all 3 are blinking, the current mode is "TEST run."	<ul style="list-style-type: none"> • The rated voltage must be present between inter-unit wirings 1 and 2. • Connect a 5 k ohm resistor between inter-unit wirings 2 and 3. When the voltage at both ends is measured, approximately 12 to 15V DC must be output and the multimeter pointer must bounce once every 8 seconds. Or instead of measuring the voltage, you can insert an LED jig and check that the LED flickers once every 8 seconds.

- If there are no problems with the above, then check the outdoor unit.
- For the "Test run" procedure, refer to the Appendix B "Installation Instructions".

(2) Checking the outdoor unit

No.	Control	Check items (unit operation)
1	Apply the rated voltage between outdoor unit terminals L and N.	• The control panel LED (red) must illuminate.
2	Short-circuit the outdoor unit COM terminal to the T-RUN terminal.	• The compressor, fan motor and 4-way valve must all turn on.

- If there are no problems with the above, then check the indoor unit.

● Using the TEST/T-RUN terminals



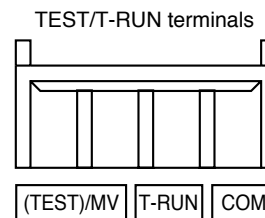



T-RUN : Test run (compressor and fan motor turn ON).
 TEST/MV : Compresses time to 1/60th (accelerates operation by 60 times faster than normal).





(3) Serial Communication Error Identification Procedure



If the lamps on the main body show the following conditions after the completion of self-diagnostics, a communication error between the indoor unit and outdoor unit might be considered. In such a case, identify the breakdown section by using the following procedure.



NOTE Refer to "Method of Self-Diagnostics" for the self-diagnostics procedure.

Lamp \ Condition	Operation 	Timer 	High Power 
E01		×	×
E12			



× : Off
 : Blinking
 : Illuminated

< Before the Operation >

 Warning	For terminal strip short circuit work or inter-unit wiring removal, turn off the power to avoid an electric shock. Release the terminal strip short circuit after the completion of self-diagnostics.	
--	--	---

 Caution	Do not perform the short-circuit work between any other terminals except for specified ones on the specified terminal strip. If such work is performed between the incorrect terminals, the unit might be broken.	 Prohibit
--	--	---

< Convenient Tool for Short-Circuit Work (for example) >



Cable

< Check Items before Troubleshooting Serial Communication Start >

After confirming that the following errors do not exist, start the "Troubleshooting Serial Communication" in "Condition: E01 and E12".

- | | |
|---|--|
| 1. Mis-wiring (inter-unit cable, etc.) | 6. Reactor failure (defective insulation, etc.) |
| 2. AC power failure | 7. High-Pressure Switch failure |
| 3. Blown fuse | 8. Overload Relay failure |
| 4. Power Relay failure | 9. Magnetic Coil failure (defective insulation, short-circuit, etc.) |
| 5. Outdoor Fan Motor failure (defective insulation, etc.) | 10. Compressor failure (defective insulation, etc.) |

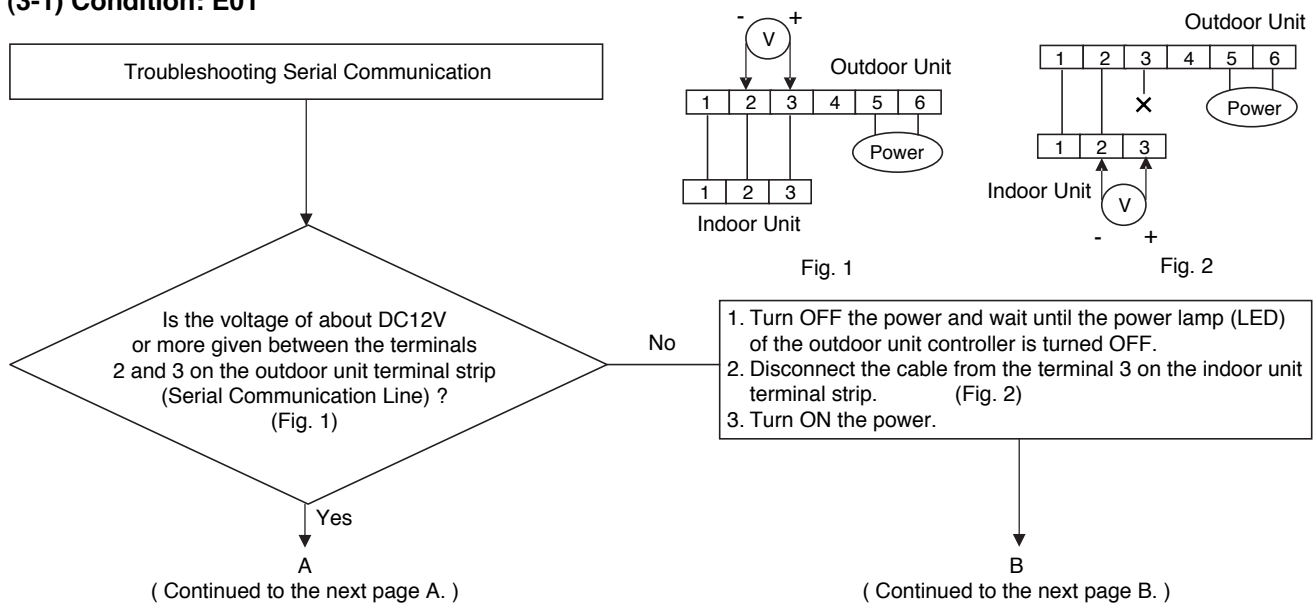
(3-1) Condition: E01



(Continued from the previous page A.)

(Continued from the previous page B.)

A

B

Yes

No

Defect or connection error in the inter-unit cable

Defect in the indoor unit P.C. board

1. Turn OFF the power and wait until the power lamp (LED) of the outdoor unit controller is turned OFF.
 2. Short-circuit between the terminals 2 and 3 on the outdoor unit terminal strip. (Fig. 3)

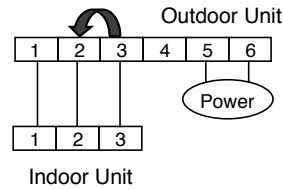
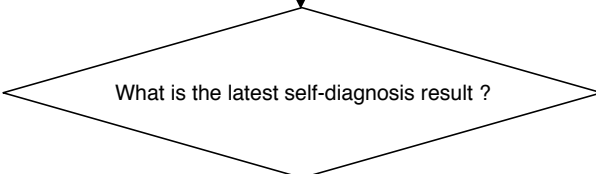

Fig. 3

1. Turn ON the power and operate the system using the remote controller or the operation button on the indoor unit.
 2. Perform the self-diagnosis five seconds after the operation start.



Condition: E12

Defect in the outdoor unit P.C. board.

Condition: E01

1. Turn off the power and wait until the power lamp (LED) of the outdoor unit controller is turned OFF.
 2. Remove the short-circuit between the terminals 2 and 3 on the outdoor unit terminal strip.
 3. Disconnect the cable from the terminal 3 on the indoor unit terminal strip. (Fig. 4)

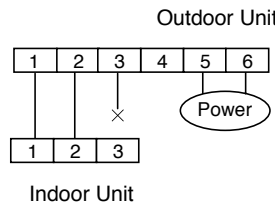

Fig. 4

Short-circuit between the terminals 2 and 3 on the indoor unit terminal board. (Fig. 5)

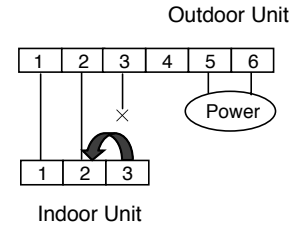
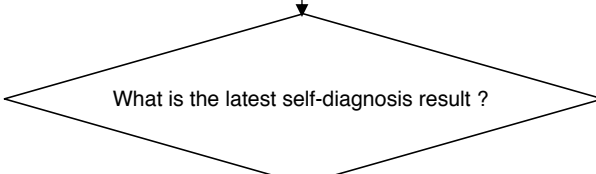

Fig. 5

1. Turn ON the power and operate the system using the remote controller or the operation button on the indoor unit.
 2. Perform the self-diagnosis five seconds after the operation start.



Condition: E12

Defect or connection error in the inter-unit cable

Condition: E01

Defect in the indoor unit P.C. board

(3-2) Condition: E12

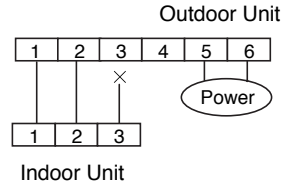
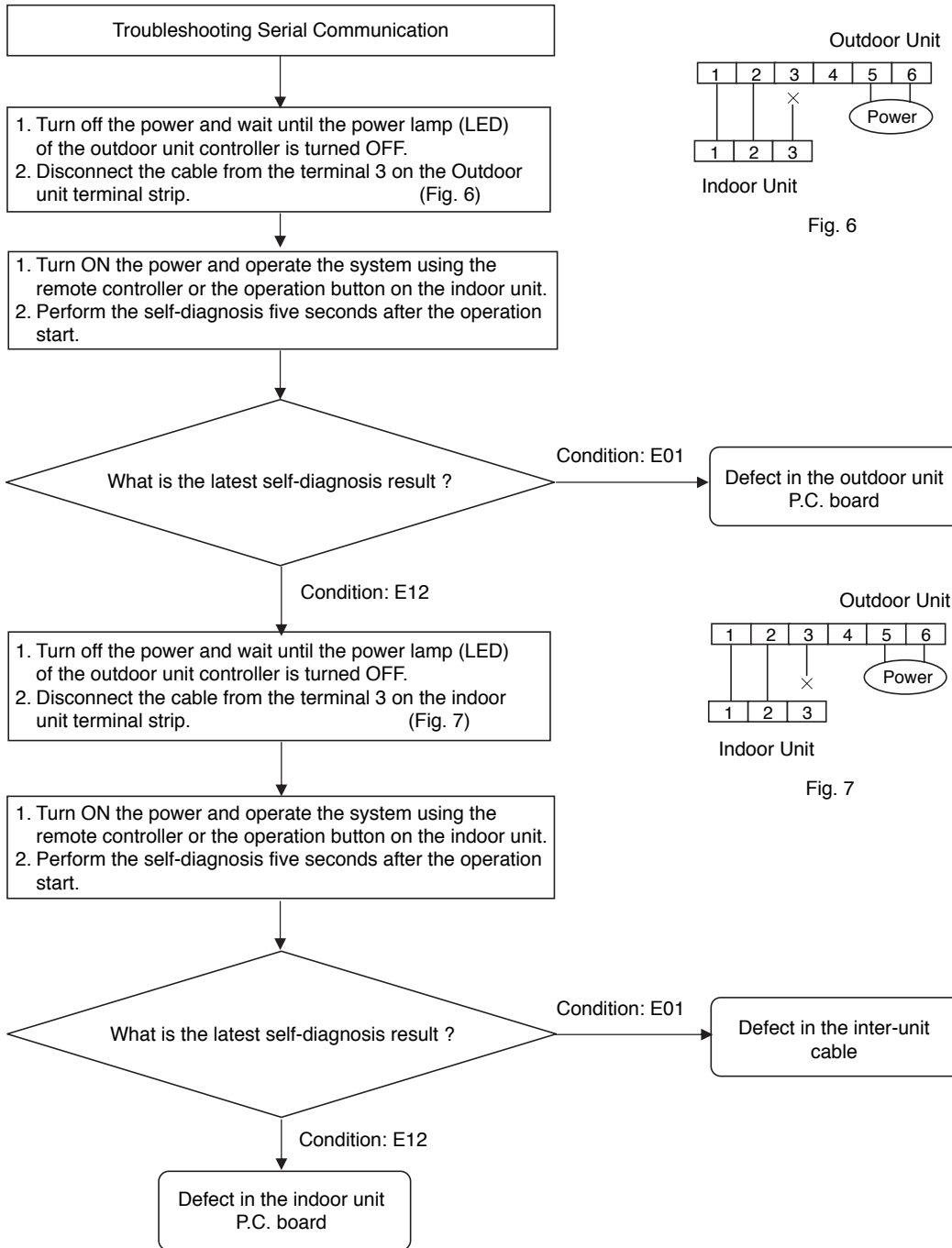

Fig. 6

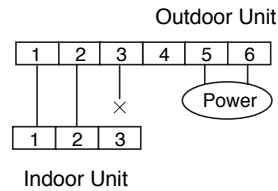

Fig. 7

8-4. Trouble Diagnosis of Fan Motor

8-4-1. Indoor Fan Motor

- This indoor DC fan motor contains an internal control PCB. Therefore, it is not possible to measure the coil resistance, and the following procedure should be used to check the motor.
- To perform diagnosis, operate the unit in cooling mode with indoor fan speed "High". Next, make sure that the indoor unit receive the signals from the remote controller when the ON/OFF operation button is pressed.

Important: (A) Turn OFF the power before connecting or disconnecting the motor connectors.
(B) When performing voltage measurement at the indoor controller connector for (3) in the table below, the DC motor will trip and voltage output will stop approximately 1 minute after operation is started. For this reason, to measure the voltage again, turn OFF the unit once using the remote controller, and then start the air conditioner again.

[Trouble symptom 1] The fan does not stop when the unit stops. → Indoor unit controller trouble.

[Trouble symptom 2] The fan motor does not rotate when the unit is operating.

(Diagnostic procedure)

* Disconnect the motor connectors and measure the voltage at the DC motor connectors on the indoor unit controller (3 locations).

Measurement location	Normal value
(1) Vm-Gnd: Between pin 1 and pin 3	DC 280V to 340V
(2) Vcc-Gnd: Between pin 4 and pin 3	DC 15V +/- 10%
(3) Vs-Gnd: Between pin 5 and pin 3	Fluctuation between DC 1.8V to 5.7V

(Diagnostic results)

All of the above measured values are normal. → Fan motor trouble (Replace the motor.)

Any one of the above measured values is not normal. → Indoor unit controller trouble (Replace the controller .)

(Reference) DC motor connector pin arrangement

Pin 1: Vm (red)
Pin 2: Not used
Pin 3: Gnd (black)
Pin 4: Vcc (white)
Pin 5: Vs (yellow)
Pin 6: PG (blue)

[Trouble symptom 3] Motor rotates for some time (several seconds), but then quickly stops, when the indoor unit operates.

(There is trouble in the system that provides feedback of motor rotation speed from the motor to the indoor unit controller.)

[Trouble symptom 4] Fan motor rotation speed does not change during indoor unit operation.

[Trouble symptom 5] Fan motor rotation speed varies excessively during indoor unit operation.

(Remedy for symptom 3 to 5)

It is not possible to identify whether the trouble is indoor unit controller trouble or motor trouble. Therefore, first replace the indoor unit controller, then (if necessary) replace the DC motor.

8-5. Noise Malfunction and Electromagnetic Interference

An inverter A/C operates using pulse signal control and high frequencies. Therefore, it is susceptible to the effects of external noise, and is likely to cause electromagnetic interference with nearby wireless devices.

A noise filter is installed for ordinary use, preventing these problems. However, depending on the installation conditions, these effects may still occur. Please pay attention to the points listed below.

(1) Noise malfunction

This refers to the application of high-frequency noise to the signal wires, resulting in abnormal signal pulses and malfunction.

Locations most susceptible to noise	Trouble	Correction
<ol style="list-style-type: none"> Locations near broadcast stations where there are strong electromagnetic waves Locations near amateur radio (short wave) stations Locations near electronic sewing machines and arc-welding machines 	<p>Either of the following trouble may occur.</p> <ol style="list-style-type: none"> The unit may stop suddenly during operation. Indicator lamps may flicker. 	<p>(The fundamental concept is to make the system less susceptible to noise.)</p> <p>- Insulate for noise or distance from the noise source. -</p> <ol style="list-style-type: none"> Use shielded wires. Move unit away from the noise source.

(2) Electromagnetic interference

This refers to noise generated by high-speed switching of the microcomputer and compressor. This noise radiates through space and returns to the electric wiring, affecting any wireless devices (televisions, radios, etc.) located nearby.

Locations most susceptible to noise	Trouble	Correction
<ol style="list-style-type: none"> A television or radio is located near the A/C and A/C wiring. The antenna cable for a television or radio is located close to the A/C and A/C wiring. Locations where television and radio signals are weak. 	<ol style="list-style-type: none"> Noise appears in the television picture, or the picture is distorted. Static occurs in the radio sound. 	<ol style="list-style-type: none"> Select a separate power source. Keep the A/C and A/C wiring at least 1 meter away from wireless devices and antenna cables. Change the wireless device's antenna to a high-sensitivity antenna. Change the antenna cable to a BS coaxial cable. Use a noise filter (for the wireless device). Use a signal booster.

APPENDIX A INSTRUCTION MANUAL

XMHS0972 & PNR-XS1872 XMHS1272 & PNR-XS1872

(OI-852-6-4181-140-00-0)

XMHS0972

XMHS1272

COOL/DRY/HEAT Model

SANYO

INSTRUCTION MANUAL

Inverter-Controlled Split System Air Conditioner

EG

MODE D'EMPLOI

Climatiseur de type séparé contrôlé par inverseur

F

**This air conditioner uses
the new refrigerant R410A.**

**Save These Instructions!
Conserver ce mode d'emploi**

Pub. OI-85264181140000

© SANYO 2009

Download from Www.Somanuals.com. All Manuals Search And Download.

FEATURES

This air conditioner is an inverter type unit that automatically adjusts capability as appropriate. Details on these functions are provided below; refer to these descriptions when using the air conditioner.

- **Microprocessor Controlled Operation**
The interior compartment of the remote control unit contains several features to facilitate automatic operation, easy logically displayed for easy use.
- **Simple One-touch Wireless Remote Control**
The remote control unit has several features to facilitate automatic operation.
- **24-Hour ON or OFF Timer**
This timer can be set to automatically turn the unit on or off at any time within a 24 hour period.
- **1-Hour OFF Timer**
This timer can be set to automatically turn off the unit at any time after one hour.
- **Night Setback**
This function saves energy by controlling operation to provide a quieter operating sound than normal.
- **Automatic and 3-step Fan Speed**
Auto/High/Medium/Low
- **Air Sweep Control**
This function moves a flap up and down in the air outlet, directing air in a sweeping motion around the room and providing comfort in every corner.
- **Auto. Flap Control**
This automatically sets the flap to the optimum position during heating, cooling, and drying operation.
- **Hot Start Heating System**
Right from the start, the air is warm and comfortable. This system prevents any cold blasts at the beginning while the heat pump is warming up, or even defrosting.
- **Automatic Restart Function for Power Failure**
Even when power failure occurs, preset programmed operation can be reactivated once power resumes.
- **High Power Operation**
If not in Auto Operation, the unit operates at maximum output for 30 minutes, regardless of the desired temperature.
The fan speed is 1 step above "High".

CONTENTS

	Page
FEATURES	2
PRODUCT INFORMATION	3
ALERT SYMBOLS	3
INSTALLATION LOCATION	3
ELECTRICAL REQUIREMENTS.....	3
SAFETY INSTRUCTIONS	3
NAMES OF PARTS.....	4
USING THE REMOTE CONTROL UNIT	8
OPERATION WITH THE REMOTE CONTROL UNIT	9
1. Automatic Operation.....	9
2. Manual Operation	9
3. Adjusting the Fan Speed	10
4. Night Setback Mode	10
5. HIGH POWER Mode	10
SPECIAL REMARKS.....	11
SETTING THE TIMER.....	11
USING THE 1-HOUR OFF TIMER.....	13
TIPS FOR ENERGY SAVING.....	13
ADJUSTING THE AIRFLOW DIRECTION	13
OPERATION WITHOUT THE REMOTE CONTROL UNIT	14
CARE AND CLEANING.....	14
TROUBLESHOOTING	16
OPERATING RANGE	16
WIRED REMOTE CONTROLLER	16

PRODUCT INFORMATION

If you have problems or questions concerning your Air Conditioner, you will need the following information. Model and serial numbers are on the nameplate on the bottom of the cabinet.

Model No. _____

Serial No. _____

Date of purchase _____

Dealer's address _____

Phone number _____

ALERT SYMBOLS

The following symbols used in this manual, alert you to potentially dangerous conditions to users, service personnel or the appliance:



WARNING

This symbol refers to a hazard or unsafe practice which can result in severe personal injury or death.



CAUTION

This symbol refers to a hazard or unsafe practice which can result in personal injury or product or property damage.

INSTALLATION LOCATION

- We recommend that this air conditioner be installed properly by qualified installation technicians in accordance with the Installation Instructions provided with the unit.
- Before installation, check that the voltage of the electric supply in your home or office is the same as the voltage shown on the nameplate.



WARNING

- Do not install this air conditioner where there are fumes or flammable gases, or in an extremely humid space such as a greenhouse.
- Do not install the air conditioner where excessively high heat-generating objects are placed.

Avoid:

To protect the air conditioner from heavy corrosion, avoid installing the outdoor unit where salty sea water can splash directly onto it or in sulphurous air near a spa.

ELECTRICAL REQUIREMENTS

1. All wiring must conform to the local electrical codes. Consult your dealer or a qualified electrician for details.
2. Each unit must be properly grounded with a ground (or earth) wire or through the supply wiring.
3. Wiring must be done by a qualified electrician.

SAFETY INSTRUCTIONS

- Read this Instruction Manual carefully before using this air conditioner. If you still have any difficulties or problems, consult your dealer for help.
- This air conditioner is designed to give you comfortable room conditions. Use this only for its intended purpose as described in this Instruction Manual.



WARNING

- Never use or store gasoline or other flammable vapor or liquid near the air conditioner — it is very dangerous.
- This air conditioner has no ventilator for intaking fresh air from outdoors. You must open doors or windows frequently when you use gas or oil heating appliances in the same room, which consume a lot of oxygen from the air. Otherwise there is a risk of suffocation in an extreme case.



CAUTION

- Do not turn the air conditioner on and off from the power mains switch. Use the ON/OFF operation button.
- Do not stick anything into the air outlet of the outdoor unit. This is dangerous because the fan is rotating at high speed.
- Do not let children play with the air conditioner.
- Do not cool or heat the room too much if babies or invalids are present.

EG

NAMES OF PARTS

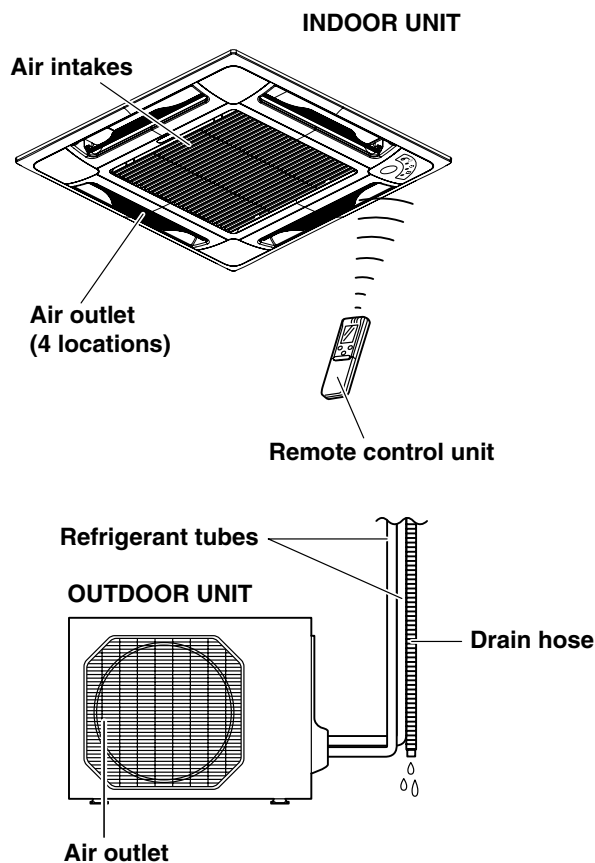

NOTE

This illustration is based on the external view of a standard model. Consequently, the shape may differ from that of the air conditioner which you have selected.

This air conditioner consists of an indoor unit and an outdoor unit. You can control the air conditioner with the remote control unit.

Air Intake	Air from the room is drawn into this section and passes through air filters which remove dust.
Air Outlet	Conditioned air is blown out of the air conditioner through the air outlet.
Remote Control Unit	The wireless remote control unit controls power ON/OFF, operation mode selection, temperature, fan speed, timer setting, and air sweeping.
Refrigerant Tubes	The indoor and outdoor units are connected by copper tubes through which refrigerant gas flows.
Drain Hose	Moisture in the room condenses and drains off through this hose.
Outdoor (Condensing) Unit	The outdoor unit contains the compressor, fan motor, heat exchanger coil, and other electrical components.

UNIT DISPLAY AND OPERATION BUTTON

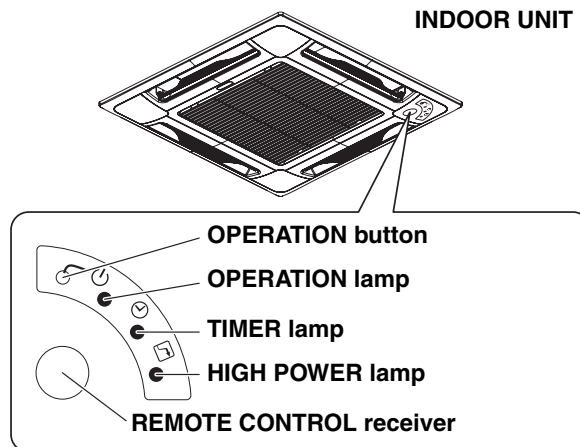

IMPORTANT

Avoid using radio equipment such as mobile phone near (within 4 ft. (1.2 m)) the remote control receiver. Some radio equipment may cause malfunction of the unit.

If the trouble happens, disconnect power and restart the air conditioner after a few minutes.

REMOTE CONTROL receiver	This section picks up infrared signals from the remote control unit (transmitter).
OPERATION button	When the remote control unit cannot be used, pressing this button enables heating and cooling operation. Each time this button is pressed, the type of operation conducted is indicated by the changing color of the OPERATION lamp. Press the button and select the lamp color that suits your preference for operation. Cooling operation (green) → Heating operation (red) → Stop (lamp off) ↑
OPERATION lamp	This lamp lights when the system is in the continuous AUTO (red or green), HEAT (red), DRY (orange) and COOL (green) mode. The OPERATION lamp lights up red and orange alternately when the system is defrosting.
TIMER lamp	This lamp lights when the system is being controlled by the timer.
HIGH POWER lamp	This lamp lights during operation in the HIGH POWER mode.

NOTE

The unit's display lamps are dimmed during operation in the NIGHT SETBACK mode.



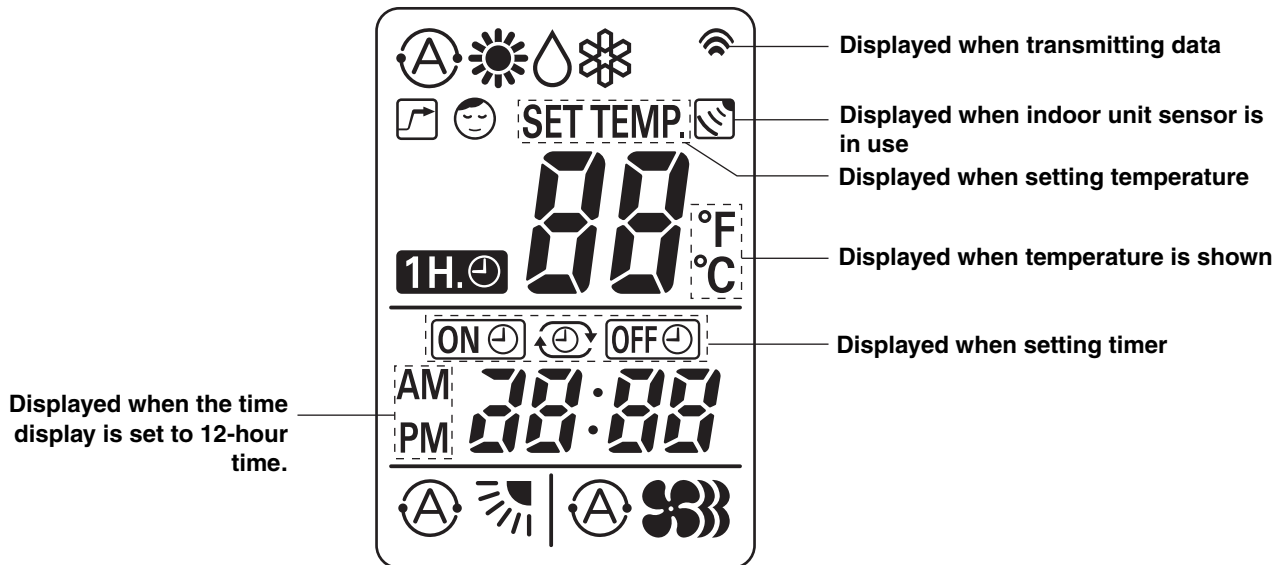

REMOTE CONTROL UNIT (DISPLAY)







EG

Symbols

(1) Operation mode

- AUTO 
- HEAT 
- MILD DRY 
- COOL 





(2) Fan speed

- Automatic operation 
- HIGH 
- MEDIUM 
- LOW 

(3) Temperature setting

- 60 – 86 °F
When set to 80 °F
temperature indication 

(4) Timer

- 24-hour clock with ON/OFF
program Timer 
- ON Timer. 
- OFF Timer. 
- 1-hour OFF Timer. 

(5) NIGHT SETBACK.....



(6) Confirmation of transmission.....



(7) Auto. flap indication.....



Flap angle indication.....



Sweep indication.....



(8) High power operation.....



REMOTE CONTROL UNIT

Transmitter

When you press the buttons on the remote control unit, the  mark appears in the display to transmit the setting changes to the receiver in the air conditioner.





Display

Information on the operating conditions is displayed while the remote control unit is switched on. If the unit is turned off, FLAP setting and FAN SPEED setting are not displayed.

HIGH POWER button





-  : If this button is pressed during HEAT, DRY or COOL operation, the unit operates at maximum output for 30 minutes, regardless of the desired temperature. The fan speed is 1step above "HIGH".

FAN SPEED selector button

-   : The air conditioner automatically decides the fan speeds.
-  : High fan speed
-  : Medium fan speed
-  : Low fan speed

FLAP button

Press this button either to select the setting of the airflow direction to the auto. flap in each mode or one of the six possible positions manually or to select the sweep function which moves the flap up and down automatically.

-   : Auto flap setting: If selected in a heating operation, the flap is set to position (3) in the following chart. If selected in a cooling or dry operation, the flap is set at position (7) in the following chart.
-  : The airflow direction can be set manually. (six positions)
-  : The flap moves up and down automatically.

NOTE

When you press the FLAP button, the air flow direction will be changed one by one as follows.

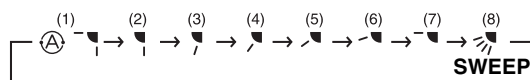





ON TIME/OFF TIME setting buttons

Advance button

Return button

No display: The timer does not operate.

-  : The air conditioner starts at the set time.
-  : The air conditioner stops at the set time.
-    : The air conditioner stops and starts, or starts and stops, at the set times every day. For details, see "SETTING THE TIMER".

CANCEL button

SENSOR button

When you press this button (use a small-tipped object such as a ballpoint pen), the  mark will appear at the display. And the room temperature is detected by the sensor which is built into the indoor unit and the air conditioner is controlled accordingly.

NOTE

If the remote control unit is located near a heat source, such as a space heater or in direct sunlight, press the SENSOR button to switch to the sensor on the indoor unit.

ADDRESS switch

- The address switch changes to prevent mixing of signals from remote control units when two air conditioners are installed next to each other. Normally, the address switch is set to A. For more information, please contact the dealer where you made the purchase.
- Normally, the tabs on the remote control unit should not be bent.

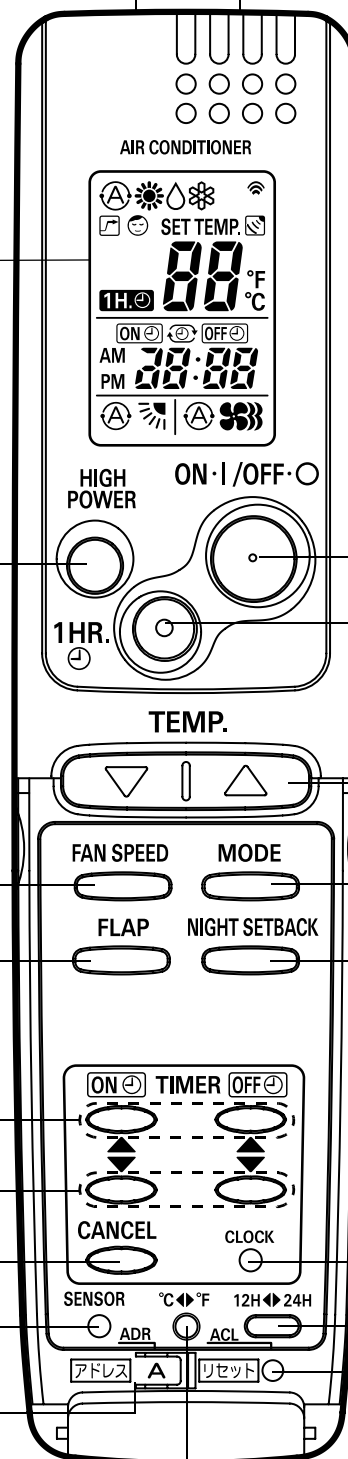

Temperature display selector button

This switches the temperature display between °C and °F.

Sensor

A temperature sensor inside the remote control unit senses the room temperature.

ON/OFF operation button

This button is for turning the air conditioner on and off.

1 HR. TIMER button (1-HOUR OFF TIMER)

1H. : When you press this button, regardless of whether the unit is operating or stopping, the unit operates for one hour and then shuts down.

Temperature setting buttons (TEMP.)

Press the  button to increase the set temperature.

Press the  button to reduce the set temperature.

The temperature setting changes by 1 °C or 2 °F each time one of the TEMP. buttons is pressed.

MODE selector button

Use this button to select AUTO, HEAT, DRY or COOL mode.

(AUTO)  : When this setting is selected, the air conditioner calculates the difference between the thermostat setting and the room temperature and automatically switches to the "COOL" or "HEAT" mode as appropriate.

(HEAT)  : The air conditioner makes the room warmer.

(DRY)  : The air conditioner reduces the humidity in the room.

(COOL)  : The air conditioner makes the room cooler.

NIGHT SETBACK button

For details, see "4. Night Setback Mode". When you press this button in the HEAT, DRY or COOL mode, the  mark appears in the display, and the remote control unit will automatically adjust the set temperature to save energy.

CLOCK button

Time display selector button

This switches the time display between 24-hour time and 12-hour time.

ACL button (ALL CLEAR)

Puts the remote control unit into pre-operation status. Always press this button after replacing the batteries.

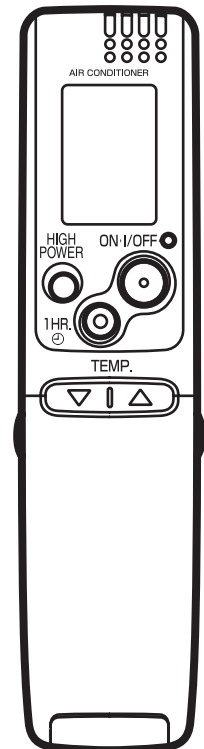

(Cover closed)

NOTE

- The illustration above pictures the remote control unit after the cover has been opened.
- The remote control unit sends the temperature signal to the air conditioner regularly at five minute intervals. If the signal from the remote control unit stops for more than 15 minutes due to the loss of the remote control unit or other trouble, the air conditioner will switch to the temperature sensor which is built into the indoor unit and control the room temperature. In these cases, the temperature around the remote control unit may differ from the temperature detected at the air conditioner's position.
- The indoor fan runs continuously when the system is in normal operation. It does not turn off when the desired room temperature is reached. If Night Set Back mode is selected, the fan will turn off intermittently during cooling operation in order to control air flow.

USING THE REMOTE CONTROL UNIT

HOW TO INSTALL BATTERIES

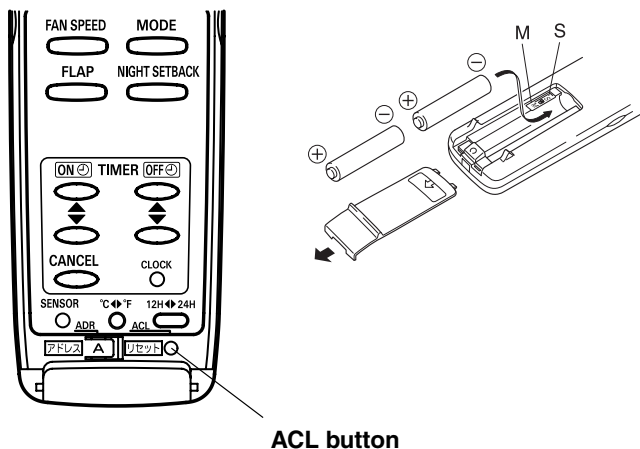

1. Slide the cover in the direction indicated by the arrow and remove it.
2. Install two AAA alkaline batteries. Make sure the batteries point in the direction marked in the battery compartment.
3. Use a thin object such as the tip of a pen to press the ACL button.

NOTE

- The batteries last about six months, depending on how much you use the remote control unit. Replace the batteries when the remote control unit's display fails to light, or when the remote control unit cannot be used to change the air conditioner's settings.
- Use two fresh leak-proof type-AAA alkaline batteries.
- In replacing batteries, follow the instructions as mentioned in the subsection "HOW TO INSTALL BATTERIES".
- If you do not use the remote control unit more than 1 month, take out the batteries.
- Dispose of the used batteries at the designated location in compliance with the applicable local ordinances.

S/M (Single/Multiple switch)

- Initially, the S/M switch is set to S (Single).
- Set this switch to M (Multiple) for multiple operation.
- Always press ACL button by a thin object such as the tip of a pen after setting the S/M switch.

NOTE

When multiple indoor units are used and units in other rooms are already operating, they will be operating with the same mode as the operating indoor units.

HOW TO USE THE REMOTE CONTROL UNIT

When using the remote control unit, always point the unit's transmitter head directly at the air conditioner's receiver.

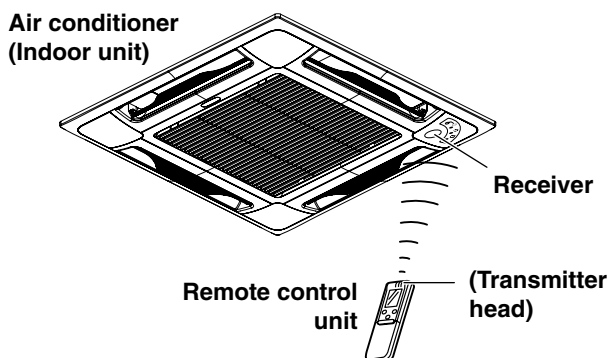

REMOTE CONTROL UNIT INSTALLATION POSITION

The remote control unit may be operated either from a non-fixed position or from a wall-mounted position. To ensure that the air conditioner operates correctly, DO NOT install the remote control unit in the following places:

DO NOT

- In direct sunlight
- Behind a curtain or other places where it is covered
- More than 26 ft.(8 m) away from the air conditioner
- In the path of the air conditioner's airstream
- Where it may become extremely hot or cold
- Where it may be subject to electrical or magnetic noise
- Where there is an obstacle between the remote control unit and air conditioner (since a check signal is sent from the remote control unit every 5 minutes)

MOUNTING THE REMOTE CONTROL UNIT

Before mounting the remote control unit, press the ON/OFF operation button at the mounting location to make sure that the air conditioner operates from that location. The indoor unit should make a beeping sound to indicate that it has received the signal.

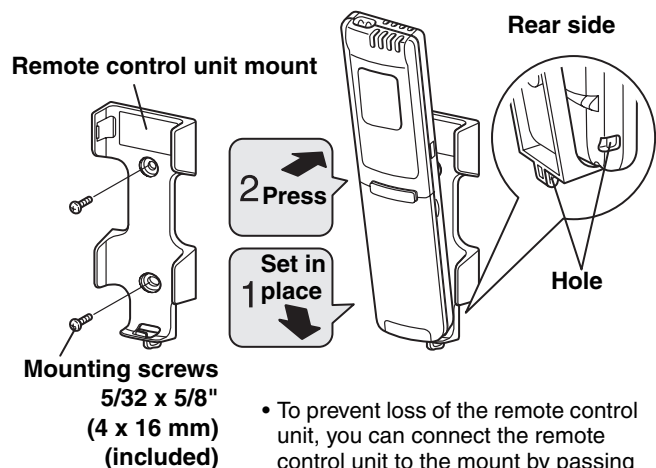

To take out the remote control unit, pull it forward.

WHEN HOLDING THE REMOTE CONTROL UNIT

- When using the remote control unit and during air conditioner operation, the transmitter on the remote control unit should be pointed towards the receiver on the indoor unit.
- Make sure that there are no objects between the remote control unit and receiver which could block the signal.

OPERATION WITH THE REMOTE CONTROL UNIT

1. Automatic Operation

The air conditioner calculates the difference between the thermostat setting and room temperature, and automatically determines the mode to operate under cooling or heating. Then, the air conditioner continuously operates under the mode selected at initial operation.

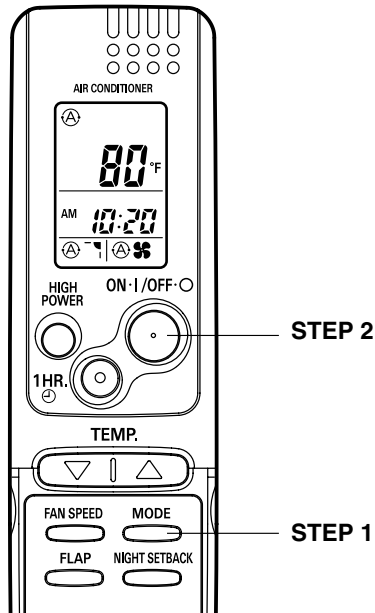

NOTE Check that the circuit breaker on the power panel is turned on.

Once **A** mode is selected and the unit is preset by following the steps below, you can have the air conditioner automatically bring the room to the desired temperature simply by pressing the ON/OFF operation button.

STEP 1	Press the MODE selector button to A .
STEP 2	Press the ON/OFF operation button.

To stop the air conditioner, press the ON/OFF operation button again.

NOTE • To change the temperature setting; press the temperature setting buttons and change the setting to the desired temperature.

2. Manual Operation

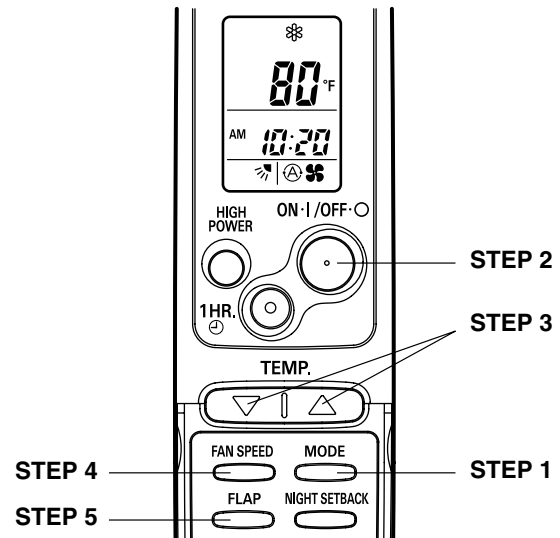

NOTE Check that the circuit breaker on the power panel is turned on.

If the automatic operation settings of the unit do not meet your needs, press the setting buttons as described below and change the settings as desired.

STEP 1	Press the MODE selector button and select the desired mode. For heating operation → ☀ For dehumidifying operation → 💧 For cooling operation → ❄
STEP 2	To start the air conditioner, press the ON/OFF operation button.
STEP 3	Press the TEMP. setting buttons to change the temperature setting to the desired temperature. Adjustable temperature range: 30 °C max. or 86 °F max. 16 °C min. 60 °F min.
STEP 4	Set the FAN SPEED selector button to the setting you want.
STEP 5	Press the FLAP button and set the airflow direction as desired. (Refer to "ADJUSTING THE AIRFLOW DIRECTION" on page 13.)

To stop the air conditioner, press the ON/OFF operation button again.

NOTE

- When multiple indoor units are used and units in other rooms are already operating, they will be set to the same mode of operation as the operating indoor units.
- Choose the best position in the room for the remote control unit, which also acts as the sensor for room comfort and transmits the operating instructions. Once you've found this best position, always keep the remote control unit there.
- This appliance has a built-in 5-minute time delay circuit to ensure reliable operation. When the operation button is pressed, the compressor will start running within three minutes. In the event of power failure, the unit will stop.



3. Adjusting the Fan Speed

A. Automatic fan speed

Simply set the FAN SPEED selector button to the  position.

This automatically sets the best fan speed for the room temperature.

B. Manual fan speed

If you want to adjust fan speed manually during operation, just set the FAN SPEED selector button as desired. [, , or ]

4. Night Setback Mode

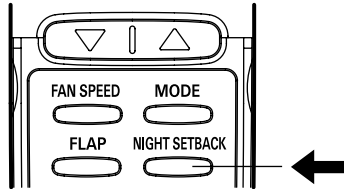
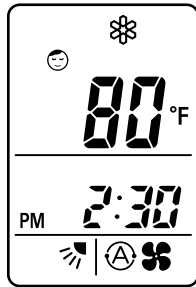

Night Setback Mode is used for saving energy.

Press the NIGHT SETBACK button while operation. The  mark appears in the display.

To release the night setback function, press the NIGHT SETBACK button again.

A. In Cooling and DRY Mode: (and)

When the night setback mode is selected, the air conditioner automatically raises the temperature setting 2 °F when 30 minutes have passed after the selection was made, and then another 2 °F after another 30 minutes have passed, regardless of the indoor temperature when night setback was selected. This enables you to save energy without sacrificing comfort. This function is convenient when gentle cooling is needed.

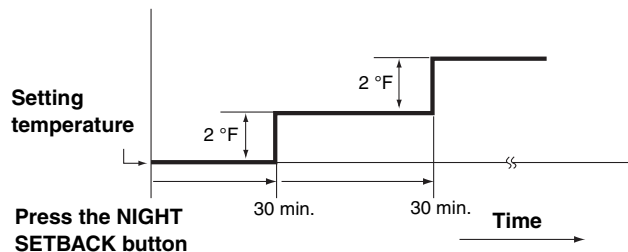

B. In Heating Mode: ()

When the night setback mode is selected, the air conditioner automatically lowers the temperature setting 4 °F when 30 minutes have passed after the selection was made, and then another 4 °F after another 30 minutes have passed, regardless of the indoor temperature when night setback was selected. This enables you to save energy without sacrificing comfort. This function is convenient when gentle heating is needed.

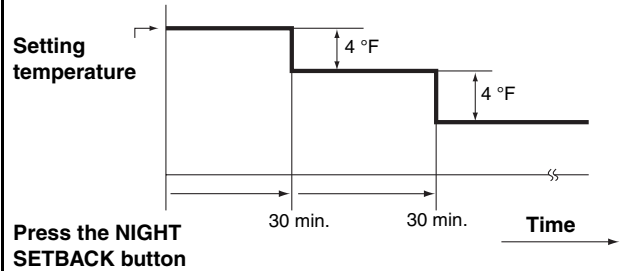

5. HIGH POWER Mode

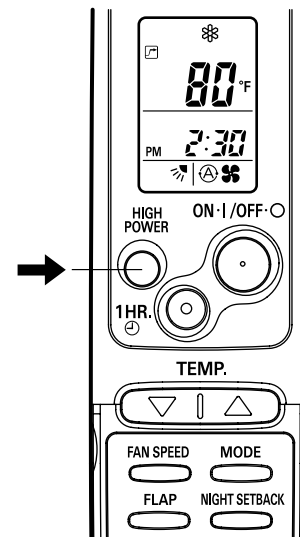

HIGH POWER mode can be used to increase the output of the indoor unit for all operation modes except automatic operation.

Press the HIGH POWER button while operation. The  mark appears in the display.

To cancel, press HIGH POWER button again.

- When the HIGH POWER button is pressed, the unit operates at maximum output for 30 minutes, regardless of the desired temperature. The fan speed is 1 step above "High".
- HIGH POWER Mode cannot be used when the operation mode is Automatic Operation.

NOTE

- When set to High fan speed during heating operation, the fan runs at High fan speed even though the  mark is displayed.
- Depending on the operating conditions, the fan speed may be increased by a small amount only.

SPECIAL REMARKS

“DRY” (△) Operation

How it works?

- Once the room temperature reaches the level that was set, the unit's operation frequency is changed automatically.
- During DRY operation, the fan speed automatically runs at lower speed for providing a comfortable breeze.
- “DRY” operation is not possible if the indoor temperature is 59 °F or less.

Heating (☀) Operation

Heating performance

- Because this air conditioner heats a room by drawing in the heat of the outside air (heat pump system), the heating efficiency will fall off when the outdoor temperature is very low. If sufficient heat cannot be obtained with this air conditioner, use another heating appliance together with it.

Defrosting

- When the outdoor temperature is low, frost or ice may form on the heat exchanger coil, reducing heating performance. When this happens, a microcomputer defrosting system operates. At the same time, the fan on the indoor unit stops and the OPERATION lamp lights red and orange alternately until defrosting is completed. Heating operation restarts after several minutes. (This interval will vary slightly depending upon the outdoor temperature and the way in which frost forms.)

Cold draft prevention

- For several minutes after the start of heating operation, the indoor fan runs at a lower speed until the indoor heat exchanger coil has warmed up sufficiently. However, the fan may remain stopped when the room temperature is low. This is because the COLD DRAFT PREVENTION SYSTEM is in operation.

Cooling (❄) operation

- Sometimes the indoor unit may not get to the set fan speed such as LOW under cool operation at very low outdoor temperatures due to the indoor unit being protected from ice or frost.

Power failure during operation

- In the event of power failure, the unit will stop. When the power is resumed, the unit will restart automatically in approximately 15 minutes by the remote control unit.

Clicking Sound

Clicking sound is heard from the air conditioner

- In heating or cooling operation, any plastic parts may expand or shrink due to a sudden temperature change. In this event, a clicking sound may occur. This is normal, and the sound will soon disappear.

Remote Control Unit

- The remote control unit sends the setting condition to the air conditioner regularly at five minute intervals.

SETTING THE TIMER

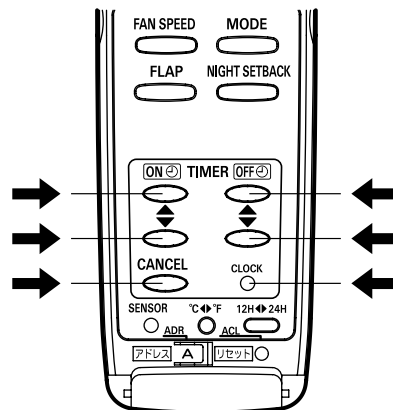

NOTE

In the descriptions below, the following settings are used for the temperature and time indicator selector button on the bottom front section of the remote control unit.

- Temperature: °F
- Time: AM, PM

1. How to set the present time

(Example) To set to 10:30 pm.

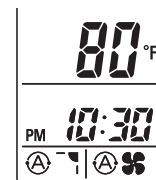
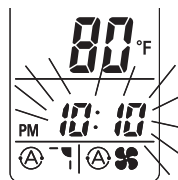

Operation	Indication
1. Press the CLOCK button once if the time indicator is not flashing.	The time indication alone flashes.
2. Press the Advance, Return (▲, ▼) button until PM 10:30 is displayed.	The time can be set in 1-minute increments. Holding down the button advances the time rapidly in 10-minute increments.
3. Press the CLOCK button again.	This completes the setting of the current time.

2. How to set the OFF time

(Example) To stop the air conditioner at 11:00 am.

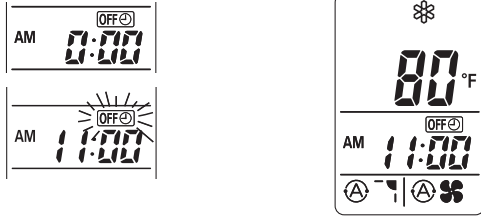

Operation	Indication
1. Press the OFF TIME setting button once.	The timer OFF indication is displayed, and the present OFF time is shown.
2. Press the Advance, Return (▲ , ▼) button until AM 11:00 is displayed.	The timer OFF indication blinks. The time can be set in 10-minute increments. Holding down the button advances the time rapidly in 10-minute increments.
3. Wait a few seconds, and then the setting is complete.	The timer OFF indication stops blinking and the present time is displayed.

3. How to set the ON time

(Example) To start operation at 7:10 am.

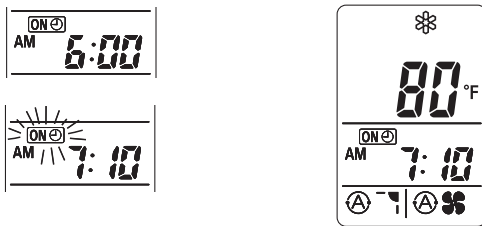

Operation	Indication
1. Press the ON TIME setting button once.	The timer ON indication is displayed, and the present ON time is shown.
2. Press the Advance, Return (▲ , ▼) button until AM 7:10 is displayed.	The timer ON indication blinks. The time can be set in 10-minute increments. Holding down the button advances the time rapidly in 10-minute increments.
3. Wait a few seconds, and then the setting is complete.	The timer ON indication stops blinking and the present time is displayed.

4. How to set daily ON/OFF repeat timer

(Example) To start operation at 7:10 am. and stop the air conditioner at 11:00 am.

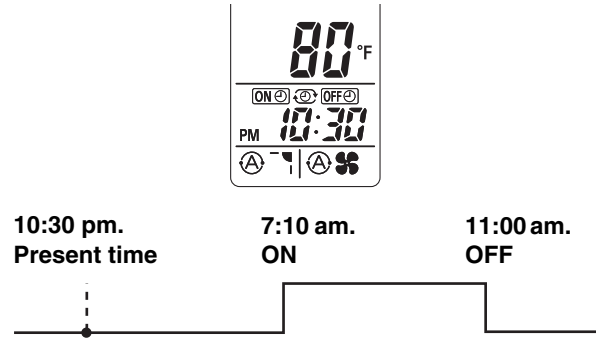

Operation	Indication
1. Set the timer ON/OFF times as shown in 2-1, 2, 3 and 3-1, 2, 3.	The present time 10:30 pm. and ON OFF are displayed.

NOTE

- The ON/OFF combination timer uses the current time as the reference, and it is activated starting from whichever set time comes first.
- With the ON/OFF combination timer, the settings are repeated every day.
- You can check the timer ON/OFF times after you have set them by pressing the ON TIME and OFF TIME setting buttons.

To cancel a timer program

- Press the CANCEL button.
- When either an ON or OFF timer is to be canceled, press the button corresponding to the timer whose program is to be canceled, and then press the CANCEL button.

NOTE

- The airflow direction, fan speed and temperature setting can be changed after a timer program has been set even when the unit is stopped. Even when operation is stopped during an ON timer program, the unit will start operating when the set time is reached provided that the program is not canceled.
- When the ON timer and OFF timer are set to the same time, the timer operates as if it is turned off.

USING THE 1-HOUR OFF TIMER

1. 1-Hour OFF Timer

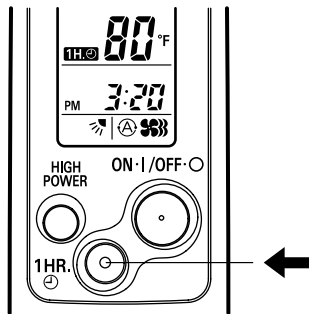

This function causes the unit to operate for one hour and then stop, regardless of whether the unit is on or off when this button is pressed.

The **1H.** indicator in the display indicates that this function is operating.

Setting procedure:

Regardless of whether the unit is operating or stopped, press the 1 HR. TIMER button.

1H. appears in the display.

Cancellation procedure:

Press the ON/OFF operation button to turn the unit off, wait for the unit to stop operating, and then press the ON/OFF operation button again.

The 1-Hour Timer function is now cancelled and the unit operates normally.

NOTE

- If, while the 1-Hour Timer function is operating, the 1HR. TIMER button is pressed once to cancel the function and then again, the unit continues to operate for one hour from that point in time and then stops.
- It is not possible to use the OFF Timer and 1-Hour OFF Timer together. Whichever function is set last takes precedence. If the 1 HR. TIMER button is pressed while the TIMER OFF function operates, the OFF Timer is cancelled and the unit will stop operating one hour later.

2. Operation together with the daily ON/OFF repeat timer

The 1-Hour OFF Timer setting is given priority over the DAILY ON/OFF REPEAT setting.

TIPS FOR ENERGY SAVING

Do not

- Block the air intake and outlet of the unit. If they are obstructed, the unit will not work well, and may be damaged.
- Let direct sunlight into the room. Use sunshades, blinds or curtains. If the walls and ceiling of the room are warmed by the sun, it will take longer to cool the room.

Do

- Always try to keep the air filter clean. (Refer to "CARE AND CLEANING".) A clogged filter will impair the performance of the unit.
- To prevent conditioned air from escaping, keep windows, doors and any other openings closed.

ADJUSTING THE AIRFLOW DIRECTION

The vertical airflow can be adjusted by moving the flap with the remote control unit. Do not move the flap with your hands. Confirm that the remote control unit has been turned on. Use the FLAP button to set either the sweep function or one of the six airflow direction settings.

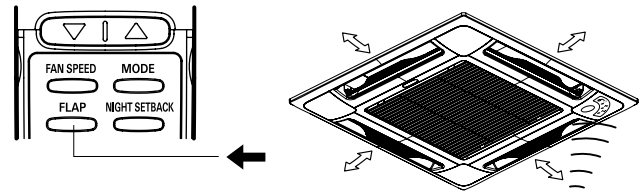

A. Sweep function

The flap starts moving up and down to deliver air over the sweep range.

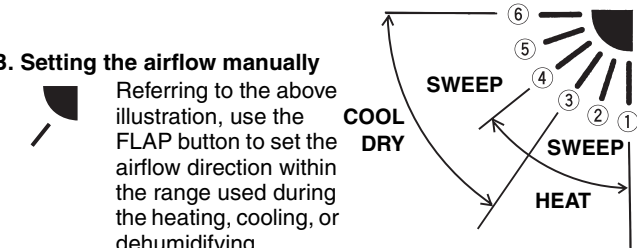

B. Setting the airflow manually

Referring to the above illustration, use the FLAP button to set the airflow direction within the range used during the heating, cooling, or dehumidifying operation.

C. Auto flap function

The flap is set to the recommended position.

NOTE

- The flap automatically closes when the unit is off.
- During the heating operation, the fan speed will be very low and the flap will be in the horizontal position (position ⑥) until the air being blown out of the unit begins to warm. Once the air warms up, the flap position and fan speed change to the settings specified with the remote control unit.



- Use the FLAP button on the remote control unit to adjust the position of the flap. If you move the flap by hand, the flap position according to the remote control unit and the actual flap position may no longer match. If this should happen, shut off the unit, wait for the flap to close, and then turn on the unit again; the flap position will now be normal again.
- Do not have the flap pointed down during cooling operation. Condensation may begin to form around the air vent and drip down.

OPERATION WITHOUT THE REMOTE CONTROL UNIT

INDOOR UNIT

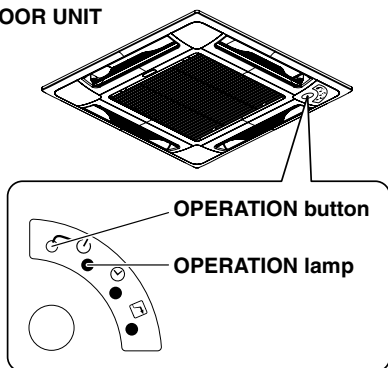

If you have lost the remote control unit or it has trouble, follow the steps below.

When the air conditioner is not running

Each time the OPERATION button is pressed, the type of operation conducted is indicated by the changing color of the OPERATION lamp. Press the button and select the lamp color that suits your preference for operation.

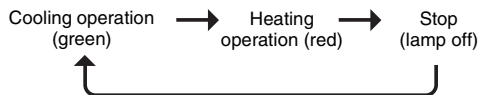

NOTE

The temperature is set to the room temperature minus 4°F during the cooling operation and to the room temperature plus 4°F during the heating operation, and the fan speed and flap are set to Auto.

CARE AND CLEANING



WARNING

- Cleaning and maintenance operations must be carried out by specially trained personnel. While working in high places, slipping or falling may result in serious injury.
- For safety, be sure to turn the air conditioner off and also to disconnect the power before cleaning.
- Do not pour water on the indoor unit to clean it. This will damage the internal components and cause an electric shock hazard.

Ceiling panel (Indoor Unit)

Clean the ceiling panel of the indoor unit with a vacuum cleaner brush, or wipe it with a clean, soft cloth.

If it is stained, use a clean cloth moistened with a mild liquid detergent. When cleaning it, be careful not to force the flaps out of place.



CAUTION

- Never use solvents, or harsh chemicals when cleaning the indoor unit. Do not wipe the plastic casing using very hot water.
- Some metal edges and the fins are sharp and may cause injury if handled improperly; be especially careful when you clean these parts.
- The internal coil and other components of the outdoor unit must be cleaned every year. Consult your dealer or service center.

Cleaning the flaps

- The air outlet flap can be removed and washed with water.
- Be sure to always stop operation before removing the flap.
- After washing with water, allow it to dry, and then remount it.

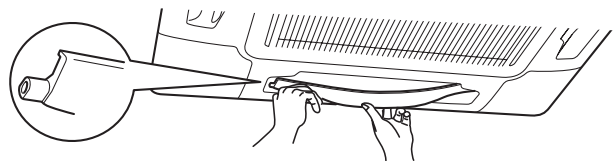

CAUTION

- Do not move the flap with your hands.
- When using a footstool or the like, be careful not to let it tip over.

Cleaning the main unit and remote control unit

- Wipe clean using a soft, dry cloth.
- To remove stubborn dirt, moisten a cloth in warm water no hotter than 104 °F, wring thoroughly, and then wipe.

Air filter

The air filter collects dust and other particles from the air and should be cleaned once every 6 months.

If the filter gets blocked, the efficiency of the air conditioner drops greatly.

NOTE

The frequency with which the filter should be cleaned depends on the environment in which the unit is used.

How to remove the filter

1. Slide the two latches of the air intake grille with your thumbs in the direction of the arrow to open the grille.

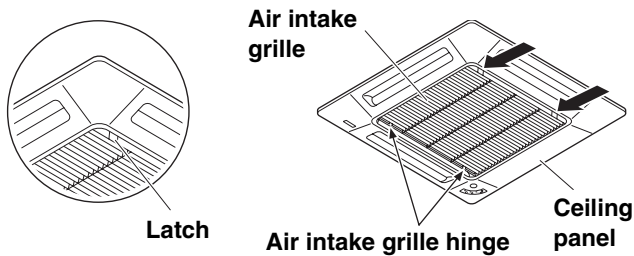

2. Open the air intake grille downward.



3. Press the tabs on both sides of the air filter (indicated with ◁ marks on the grill) to release the filter, and then, lift and pull the filter up and out using the tabs to remove it.

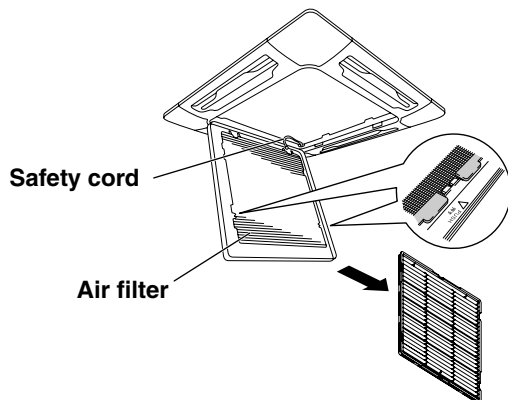

4. Use a vacuum cleaner to remove light dust. If there is sticky dust on the filter, wash the filter in lukewarm, soapy water, rinse it in clean water, and dry it.
5. Insert the filter correctly again inside the grille, close the grille letting the latches slide towards the outside and fix again the latch.

How to remove the air intake grille

1. Open the air intake grille.
2. Detach the safety cord from the frame (remember to attach it again after cleaning or maintenance).
3. Hold on the air intake grille and pull it towards you to detach the two air intake grille hinges.
4. Clean the grille gently using a soft sponge, or the like. Then dry it with care.
Neutral detergent may be used to remove stubborn dirt. Then rinse thoroughly with water and dry it.

Air intake grille hinge

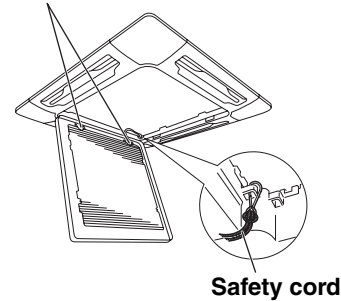

CAUTION

- When cleaning the air filter, never remove the safety cord. If it is necessary to remove it for servicing and maintenance inside, be sure to reinstall the safety cord securely (hook on the grille side) after the work.
- When the air intake grille has been opened, rotating parts (such as the fan), electrically charged areas, etc. will be exposed in the unit's opening. Bear in mind the dangers that these parts and areas pose, and proceed with the work carefully.
- Periodically check the outdoor unit to see if the air outlet or air intake is clogged with dirt or soot.

Care: After a prolonged idle period

Check the indoor and outdoor unit air intakes and outlets for blockage; if there is a blockage, remove it.

Care: Before a prolonged idle period

- Operate the fan for half a day to dry out the inside.
- Disconnect the power supply and also turn off the circuit breaker.
- Clean the air filter and replace it in its original position.
- Outdoor unit internal components must be checked and cleaned periodically.
Contact your local dealer for this service.

TROUBLESHOOTING

If your air conditioner does not work properly, first check the following points before requesting service. If it still does not work properly, contact your dealer or service center.

Trouble	Possible Cause	Remedy
Air conditioner does not run at all.	<ol style="list-style-type: none"> Power failure. Leakage circuit breaker tripped. Line voltage is too low. Batteries in remote control unit have run down. 	<ol style="list-style-type: none"> Restore power. Contact service center. Consult your electrician or dealer. Replace batteries.
OPERATION lamp blinks and air conditioner does not operate.	Trouble in system.	Contact service center.
Compressor runs but soon stops.	Obstruction in front of condenser coil.	Remove obstruction.
Poor cooling (or heating) performance.	<ol style="list-style-type: none"> Dirty or clogged air filter. Heat source or many people in room. Doors and/or windows are open. Obstacle near air intake or air discharge port. Thermostat is set too high for cooling (or too low for heating). (Outdoor temperature is too low for heating.) 	<ol style="list-style-type: none"> Clean air filter to improve airflow. Eliminate heat source if possible. Shut them to keep the heat (or cold) out. Remove it to ensure good airflow. Set the temperature lower (or higher). (Consult your dealer or try to use another heat appliance.)
Clicking sound is heard from the air conditioner.	In heating or cooling operation, any plastic parts may expand or shrink due to a sudden temperature change. In this event, a clicking sound may occur.	This is normal, and the sound will soon disappear.
OPERATION lamp lights but outdoor unit will not run.	The use of cellular phones near the air conditioner may cause disturbance to its normal operation.	<ol style="list-style-type: none"> Turn off the power then restart the air conditioner after a while. Consult your dealer.
TIMER lamp blinks (3 sec. interval) and air conditioner does not operate.	FLOAT SWITCH is activated.	Contact service center.

OPERATING RANGE

The air conditioner is operable within the temperature ranges as listed below:

	Temperature	Indoor air temperature	Outdoor air temperature
COOLING	Max.	95 °F DB / 71 °F WB	115 °F DB
	Min.	67 °F DB / 57 °F WB	67 °F DB
HEATING	Max.	80 °F DB / 67 °F WB	75 °F DB / 65 °F WB
	Min.	- DB / - WB	0 °F DB

WIRED REMOTE CONTROLLER

A separately sold wired remote controller (STK-RCS-7TWSU, 7TWSUA) used with this air conditioner is also available. If you wish to use the wired remote control function, you will need to purchase the optional wired remote controller.

APPENDIX B INSTRUCTION MANUAL

XHS1872 & PNR-XS1872

(OI-852-6-4181-107-00-1)

XHS1271

XHS1872

COOL/DRY/HEAT Model

SANYO

INSTRUCTION MANUAL

Inverter-Controlled Split System Air Conditioner

EG

MODE D'EMPLOI

Climatiseur de type séparé contrôlé par inverseur

F

**This air conditioner uses
the new refrigerant R410A.**

**Save These Instructions!
Conserver ce mode d'emploi**

Pub. OI-85264181107001

© SANYO 2009

Download from Www.Somanuals.com. All Manuals Search And Download.

FEATURES

This air conditioner is an inverter type unit that automatically adjusts capability as appropriate. Details on these functions are provided below; refer to these descriptions when using the air conditioner.

- **Microprocessor Controlled Operation**
The interior compartment of the remote control unit contains several features to facilitate automatic operation, easy logically displayed for easy use.
- **Simple One-touch Wireless Remote Control**
The remote control unit has several features to facilitate automatic operation.
- **24-Hour ON or OFF Timer**
This timer can be set to automatically turn the unit on or off at any time within a 24 hour period.
- **1-Hour OFF Timer**
This timer can be set to automatically turn off the unit at any time after one hour.
- **Night Setback**
This function saves energy by controlling operation to provide a quieter operating sound than normal.
- **Automatic and 3-step Fan Speed**
Auto/High/Medium/Low
- **Air Sweep Control**
This function moves a flap up and down in the air outlet, directing air in a sweeping motion around the room and providing comfort in every corner.
- **Auto. Flap Control**
This automatically sets the flap to the optimum position during heating, cooling, and drying operation.
- **Automatic Switching between Cooling and Heating**
When the remote control's S/M switch is at the "S" (Single) position
This unit automatically switches between cooling operation and heating operation according to the difference between the room temperature and the temperature setting.
When the remote control's S/M switch is at the "M" (Multiple) position
Unlike when the switch is at the "S" position as described above, the function for automatically switching between cooling and heating does not work. Then, the air conditioner continuously operates under the mode selected at initial operation.
- **Hot Start Heating System**
Right from the start, the air is warm and comfortable. This system prevents any cold blasts at the beginning while the heat pump is warming up, or even defrosting.
- **Automatic Restart Function for Power Failure**
Even when power failure occurs, preset programmed operation can be reactivated once power resumes.
- **High Power Operation**
If not in Auto Operation, the unit operates at maximum output for 30 minutes, regardless of the desired temperature.
The fan speed is 1 step above "High".

CONTENTS

	Page
FEATURES	2
PRODUCT INFORMATION	3
ALERT SYMBOLS	3
INSTALLATION LOCATION	3
ELECTRICAL REQUIREMENTS	3
SAFETY INSTRUCTIONS	3
NAMES OF PARTS	4
USING THE REMOTE CONTROL UNIT	8
OPERATION WITH THE REMOTE CONTROL UNIT	9
1. Automatic Operation	9
2. Manual Operation	9
3. Adjusting the Fan Speed	10
4. Fan Only	10
5. Night Setback Mode	10
6. HIGH POWER Mode	10
SPECIAL REMARKS	11
SETTING THE TIMER	11
USING THE 1-HOUR OFF TIMER	13
TIPS FOR ENERGY SAVING	13
ADJUSTING THE AIRFLOW DIRECTION	13
OPERATION WITHOUT THE REMOTE CONTROL UNIT	14
CARE AND CLEANING	14
TROUBLESHOOTING	16
OPERATING RANGE	16
WIRED REMOTE CONTROLLER	16

PRODUCT INFORMATION

If you have problems or questions concerning your Air Conditioner, you will need the following information. Model and serial numbers are on the nameplate on the bottom of the cabinet.

Model No. _____

Serial No. _____

Date of purchase _____

Dealer's address _____

Phone number _____

ALERT SYMBOLS

The following symbols used in this manual, alert you to potentially dangerous conditions to users, service personnel or the appliance:



WARNING

This symbol refers to a hazard or unsafe practice which can result in severe personal injury or death.



CAUTION

This symbol refers to a hazard or unsafe practice which can result in personal injury or product or property damage.

INSTALLATION LOCATION

- We recommend that this air conditioner be installed properly by qualified installation technicians in accordance with the Installation Instructions provided with the unit.
- Before installation, check that the voltage of the electric supply in your home or office is the same as the voltage shown on the nameplate.



WARNING

- Do not install this air conditioner where there are fumes or flammable gases, or in an extremely humid space such as a greenhouse.
- Do not install the air conditioner where excessively high heat-generating objects are placed.

Avoid:

To protect the air conditioner from heavy corrosion, avoid installing the outdoor unit where salty sea water can splash directly onto it or in sulphurous air near a spa.

ELECTRICAL REQUIREMENTS

1. All wiring must conform to the local electrical codes. Consult your dealer or a qualified electrician for details.
2. Each unit must be properly grounded with a ground (or earth) wire or through the supply wiring.
3. Wiring must be done by a qualified electrician.

SAFETY INSTRUCTIONS

- Read this Instruction Manual carefully before using this air conditioner. If you still have any difficulties or problems, consult your dealer for help.
- This air conditioner is designed to give you comfortable room conditions. Use this only for its intended purpose as described in this Instruction Manual.



WARNING

- Never use or store gasoline or other flammable vapor or liquid near the air conditioner — it is very dangerous.
- This air conditioner has no ventilator for intaking fresh air from outdoors. You must open doors or windows frequently when you use gas or oil heating appliances in the same room, which consume a lot of oxygen from the air. Otherwise there is a risk of suffocation in an extreme case.



CAUTION

- Do not turn the air conditioner on and off from the power mains switch. Use the ON/OFF operation button.
- Do not stick anything into the air outlet of the outdoor unit. This is dangerous because the fan is rotating at high speed.
- Do not let children play with the air conditioner.
- Do not cool or heat the room too much if babies or invalids are present.

IMPORTANT

“Multiple use” is applied for the model XHS1872 only.

- “Single use” means that only one indoor unit is connected with one outdoor unit in a one-unit-to-one-unit configuration and that the remote control's S/M switch is at the “S” (Single) position.
- “Multiple use” (i.e. Flexi-Multi system) means that two or more indoor units are connected with one outdoor unit in a multiple-unit-to-one-unit configuration and that the remote control's S/M switch is at the “M” (Multiple) position. (Refer to “USING THE REMOTE CONTROL UNIT” on page 8.)

EG

NAMES OF PARTS

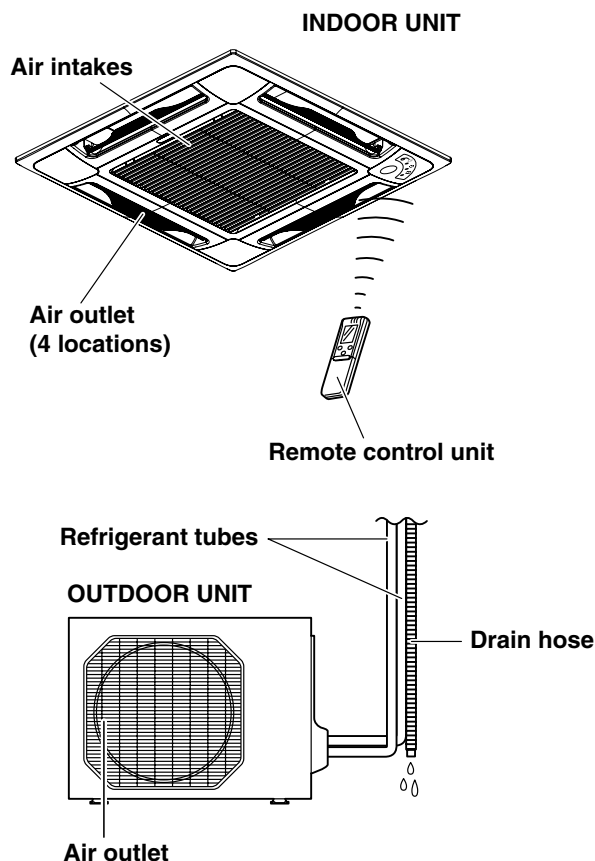

NOTE

This illustration is based on the external view of a standard model. Consequently, the shape may differ from that of the air conditioner which you have selected.

This air conditioner consists of an indoor unit and an outdoor unit. You can control the air conditioner with the remote control unit.

Air Intake	Air from the room is drawn into this section and passes through air filters which remove dust.
Air Outlet	Conditioned air is blown out of the air conditioner through the air outlet.
Remote Control Unit	The wireless remote control unit controls power ON/OFF, operation mode selection, temperature, fan speed, timer setting, and air sweeping.
Refrigerant Tubes	The indoor and outdoor units are connected by copper tubes through which refrigerant gas flows.
Drain Hose	Moisture in the room condenses and drains off through this hose.
Outdoor (Condensing) Unit	The outdoor unit contains the compressor, fan motor, heat exchanger coil, and other electrical components.

UNIT DISPLAY AND OPERATION BUTTON

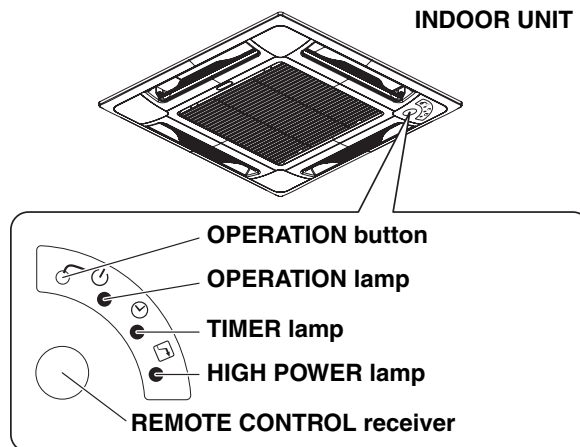

IMPORTANT

Avoid using radio equipment such as mobile phone near (within 4 ft. (1.2 m)) the remote control receiver. Some radio equipment may cause malfunction of the unit.

If the trouble happens, disconnect power and restart the air conditioner after a few minutes.

REMOTE CONTROL receiver	This section picks up infrared signals from the remote control unit (transmitter).
OPERATION button	When the remote control unit cannot be used, pressing this button enables heating and cooling operation. Each time this button is pressed, the type of operation conducted is indicated by the changing color of the OPERATION lamp. Press the button and select the lamp color that suits your preference for operation. Cooling operation (green) → Heating operation (red) → Stop (lamp off) ↑
OPERATION lamp	This lamp lights when the system is in the continuous AUTO (red or green), HEAT (red), DRY (orange), COOL (green) and FAN (green) mode (but no FAN mode at M of the S/M switch on the remote control unit). The OPERATION lamp lights up red and orange alternately when the system is defrosting.
TIMER lamp	This lamp lights when the system is being controlled by the timer.
HIGH POWER lamp	This lamp lights during operation in the HIGH POWER mode.

NOTE

The unit's display lamps are dimmed during operation in the NIGHT SETBACK mode.

REMOTE CONTROL UNIT (DISPLAY)

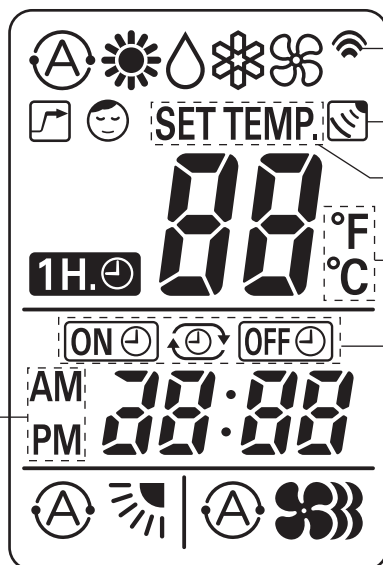

Displayed when the time display is set to 12-hour time.

Displayed when transmitting data

Displayed when indoor unit sensor is in use

Displayed when setting temperature

Displayed when temperature is shown

Displayed when setting timer

EG

Symbols

(1) Operation mode

AUTO



HEAT



MILD DRY



COOL



FAN



(2) Fan speed

Automatic operation



HIGH



MEDIUM



LOW



(3) Temperature setting

60 – 86 °F
When set to 80 °F
temperature indication.....

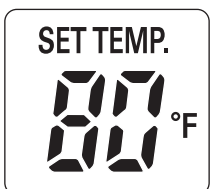

(4) Timer

24-hour clock with ON/OFF
program Timer



ON Timer.



OFF Timer.



1-hour OFF Timer.



(5) NIGHT SETBACK.....



(6) Confirmation of transmission.....



(7) Auto. flap indication.....



Flap angle indication.....



Sweep indication.....



(8) High power operation.....



REMOTE CONTROL UNIT

Transmitter

When you press the buttons on the remote control unit, the  mark appears in the display to transmit the setting changes to the receiver in the air conditioner.





Display

Information on the operating conditions is displayed while the remote control unit is switched on. If the unit is turned off, FLAP setting and FAN SPEED setting are not displayed.

HIGH POWER button



-  : If this button is pressed during HEAT, DRY, COOL or FAN operation, the unit operates at maximum output for 30 minutes, regardless of the desired temperature. The fan speed is 1step above "HIGH".

FAN SPEED selector button

-  : The air conditioner automatically decides the fan speeds.
-  : High fan speed
-  : Medium fan speed
-  : Low fan speed

FLAP button

Press this button either to select the setting of the airflow direction to the auto. flap in each mode or one of the six possible positions manually or to select the sweep function which moves the flap up and down automatically.

-  : Auto flap setting: If selected in a heating operation, the flap is set to position (3) in the following chart. If selected in a cooling or dry operation, the flap is set at position (7) in the following chart.
-  : The airflow direction can be set manually. (six positions)
-  : The flap moves up and down automatically.

NOTE

When you press the FLAP button, the air flow direction will be changed one by one as follows.

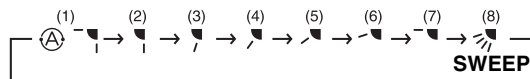





ON TIME/OFF TIME setting buttons

Advance button

Return button

No display: The timer does not operate.

-  : The air conditioner starts at the set time.
-  : The air conditioner stops at the set time.
-    : The air conditioner stops and starts, or starts and stops, at the set times every day. For details, see "SETTING THE TIMER".

CANCEL button

SENSOR button

When you press this button (use a small-tipped object such as a ballpoint pen), the  mark will appear at the display. And the room temperature is detected by the sensor which is built into the indoor unit and the air conditioner is controlled accordingly.

NOTE

If the remote control unit is located near a heat source, such as a space heater or in direct sunlight, press the SENSOR button to switch to the sensor on the indoor unit.

ADDRESS switch

- The address switch changes to prevent mixing of signals from remote control units when two air conditioners are installed next to each other. Normally, the address switch is set to A. For more information, please contact the dealer where you made the purchase.
- Normally, the tabs on the remote control unit should not be bent.

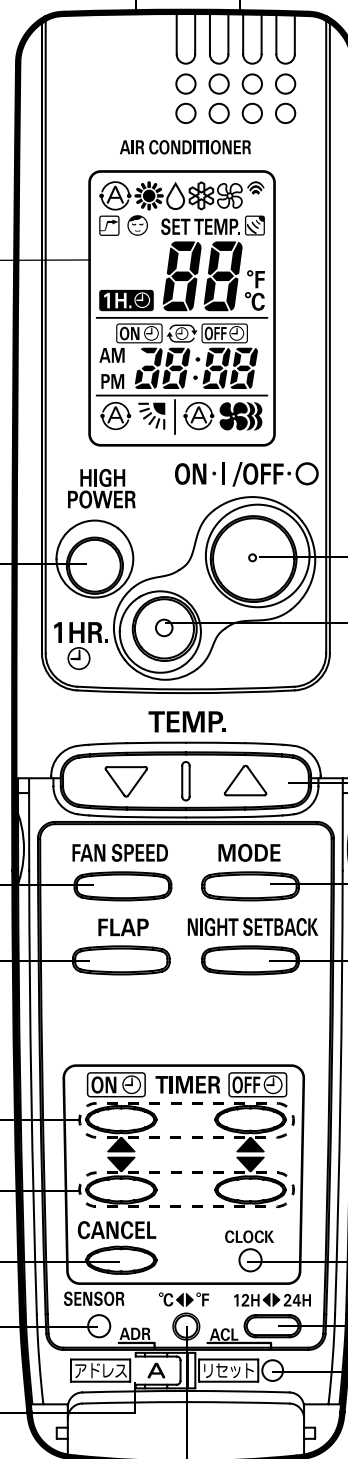

Temperature display selector button

This switches the temperature display between °C and °F.

Sensor

A temperature sensor inside the remote control unit senses the room temperature.

ON/OFF operation button

This button is for turning the air conditioner on and off.

1 HR. TIMER button (1-HOUR OFF TIMER)

1H. : When you press this button, regardless of whether the unit is operating or stopping, the unit operates for one hour and then shuts down.

Temperature setting buttons (TEMP.)

Press the  button to increase the set temperature.

Press the  button to reduce the set temperature.

The temperature setting changes by 1 °C or 2 °F each time one of the TEMP. buttons is pressed.

MODE selector button

Use this button to select AUTO, HEAT, DRY, COOL or FAN mode.

(AUTO)  : When this setting is selected, the air conditioner calculates the difference between the thermostat setting and the room temperature and automatically switches to the “COOL” or “HEAT” mode as appropriate except at “M” of the S/M switch.

(HEAT)  : The air conditioner makes the room warmer.

(DRY)  : The air conditioner reduces the humidity in the room.

(COOL)  : The air conditioner makes the room cooler.

(FAN)  : The air conditioner works only as a circulation fan except at “M” of the S/M switch.

NIGHT SETBACK button

For details, see “5. Night Setback Mode”. When you press this button in the HEAT, DRY or COOL mode, the  mark appears in the display, and the remote control unit will automatically adjust the set temperature to save energy.

CLOCK button

Time display selector button

This switches the time display between 24-hour time and 12-hour time.

ACL button (ALL CLEAR)

Puts the remote control unit into pre-operation status. Always press this button after replacing the batteries and setting the S/M switch.

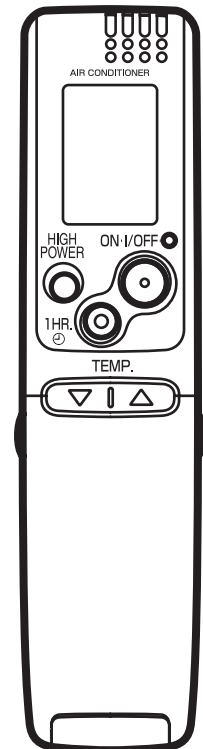

(Cover closed)

NOTE

- The illustration above pictures the remote control unit after the cover has been opened.
- The remote control unit sends the temperature signal to the air conditioner regularly at five minute intervals. If the signal from the remote control unit stops for more than 15 minutes due to the loss of the remote control unit or other trouble, the air conditioner will switch to the temperature sensor which is built into the indoor unit and control the room temperature. In these cases, the temperature around the remote control unit may differ from the temperature detected at the air conditioner’s position.
- The indoor fan runs continuously when the system is in normal operation. It does not turn off when the desired room temperature is reached. If Night Set Back mode is selected, the fan will turn off intermittently during cooling operation in order to control air flow.

USING THE REMOTE CONTROL UNIT

HOW TO INSTALL BATTERIES

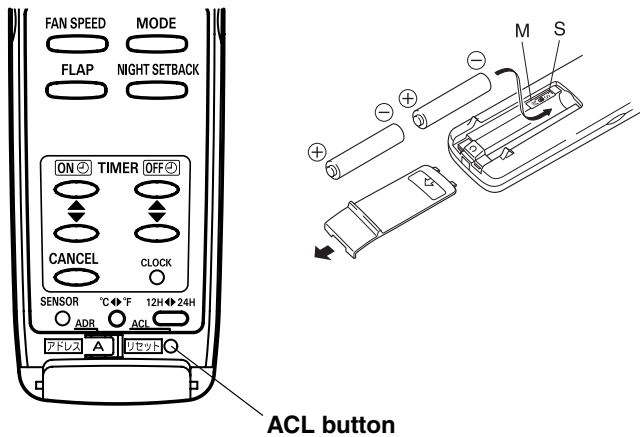

1. Slide the cover in the direction indicated by the arrow and remove it.
2. Install two AAA alkaline batteries. Make sure the batteries point in the direction marked in the battery compartment.
3. Use a thin object such as the tip of a pen to press the ACL button.

NOTE

- The batteries last about six months, depending on how much you use the remote control unit. Replace the batteries when the remote control unit's display fails to light, or when the remote control unit cannot be used to change the air conditioner's settings.
- Use two fresh leak-proof type-AAA alkaline batteries.
- In replacing batteries, follow the instructions as mentioned in the subsection "HOW TO INSTALL BATTERIES".
- If you do not use the remote control unit more than 1 month, take out the batteries.
- Dispose of the used batteries at the designated location in compliance with the applicable local ordinances.

S/M (Single/Multiple switch)

- Initially, the S/M switch is set to S (Single).
- Set this switch to M (Multiple) for multiple operation.
- Always press ACL button by a thin object such as the tip of a pen after setting the S/M switch.

NOTE

When multiple indoor units are used and units in other rooms are already operating, they will be operating with the same mode as the operating indoor units.

HOW TO USE THE REMOTE CONTROL UNIT

When using the remote control unit, always point the unit's transmitter head directly at the air conditioner's receiver.

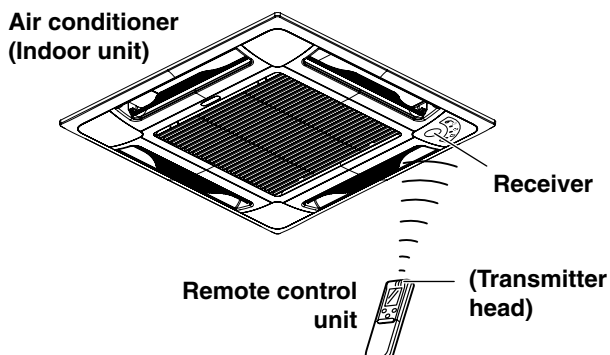

REMOTE CONTROL UNIT INSTALLATION POSITION

The remote control unit may be operated either from a non-fixed position or from a wall-mounted position. To ensure that the air conditioner operates correctly, DO NOT install the remote control unit in the following places:

DO NOT

- In direct sunlight
- Behind a curtain or other places where it is covered
- More than 26 ft.(8 m) away from the air conditioner
- In the path of the air conditioner's airstream
- Where it may become extremely hot or cold
- Where it may be subject to electrical or magnetic noise
- Where there is an obstacle between the remote control unit and air conditioner (since a check signal is sent from the remote control unit every 5 minutes)

MOUNTING THE REMOTE CONTROL UNIT

Before mounting the remote control unit, press the ON/OFF operation button at the mounting location to make sure that the air conditioner operates from that location. The indoor unit should make a beeping sound to indicate that it has received the signal.

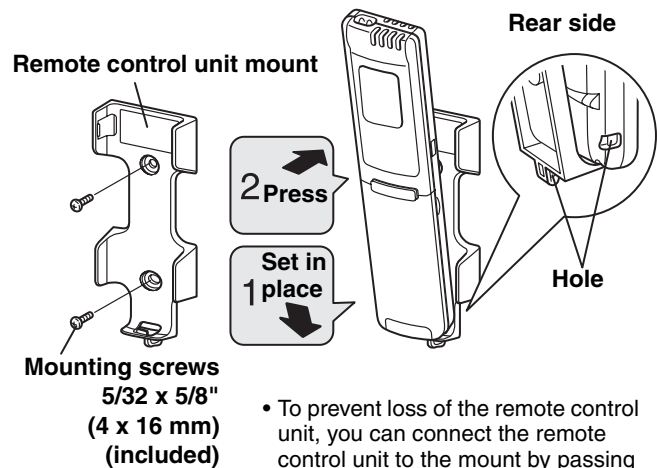

- To prevent loss of the remote control unit, you can connect the remote control unit to the mount by passing a string through the remote control unit and attachment hole.

To take out the remote control unit, pull it forward.

WHEN HOLDING THE REMOTE CONTROL UNIT

- When using the remote control unit and during air conditioner operation, the transmitter on the remote control unit should be pointed towards the receiver on the indoor unit.
- Make sure that there are no objects between the remote control unit and receiver which could block the signal.

OPERATION WITH THE REMOTE CONTROL UNIT

1. Automatic Operation

When the remote control's S/M switch is at the "S" (Single) position

This unit automatically switches between cooling operation and heating operation according to the difference between the room temperature and the temperature setting.

When the remote control's S/M switch is at the "M" (Multiple) position

Unlike when the switch is at the "S" position as described above, the function for automatically switching between cooling and heating does not work. Then, the air conditioner calculates the difference between the thermostat setting and room temperature, and automatically determines the mode to operate under cooling or heating. Then, the air conditioner continuously operates under the mode selected at initial operation.

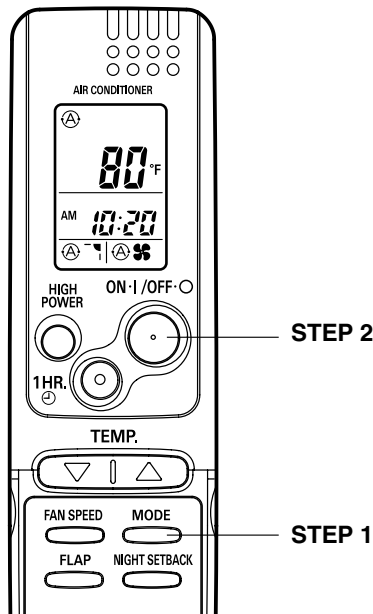

NOTE Check that the circuit breaker on the power panel is turned on.

Once (A) mode is selected and the unit is preset by following the steps below, you can have the air conditioner automatically bring the room to the desired temperature simply by pressing the ON/OFF operation button.

STEP 1	Press the MODE selector button to (A).
STEP 2	Press the ON/OFF operation button.

To stop the air conditioner, press the ON/OFF operation button again.

NOTE • To change the temperature setting; press the temperature setting buttons and change the setting to the desired temperature.

2. Manual Operation

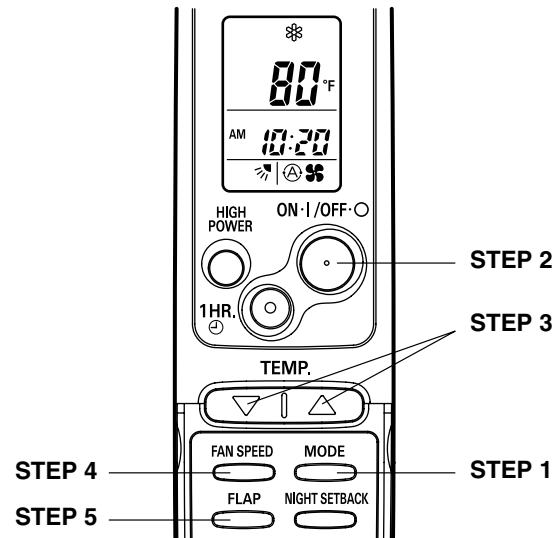

NOTE Check that the circuit breaker on the power panel is turned on.

If the automatic operation settings of the unit do not meet your needs, press the setting buttons as described below and change the settings as desired.

STEP 1	Press the MODE selector button and select the desired mode. For heating operation → ☀ For dehumidifying operation → 💧 For cooling operation → ❄ For fan only operation → 🌀 (No FAN mode at M of the S/M switch on the remote control unit.)
STEP 2	To start the air conditioner, press the ON/OFF operation button.
STEP 3	Press the TEMP. setting buttons to change the temperature setting to the desired temperature. Adjustable temperature range: 30 °C max. or 86 °F max. 16 °C min. 60 °F min.
STEP 4	Set the FAN SPEED selector button to the setting you want.
STEP 5	Press the FLAP button and set the airflow direction as desired. (Refer to "ADJUSTING THE AIRFLOW DIRECTION" on page 13.)

To stop the air conditioner, press the ON/OFF operation button again.

NOTE • Choose the best position in the room for the remote control unit, which also acts as the sensor for room comfort and transmits the operating instructions. Once you've found this best position, always keep the remote control unit there.
• This appliance has a built-in 5-minute time delay circuit to ensure reliable operation. When the operation button is pressed, the compressor will start running within three minutes. In the event of power failure, the unit will stop.

3. Adjusting the Fan Speed

A. Automatic fan speed

Simply set the FAN SPEED selector button to the position.

This automatically sets the best fan speed for the room temperature.

B. Manual fan speed

If you want to adjust fan speed manually during operation, just set the FAN SPEED selector button as desired. [, , or]

4. Fan Only

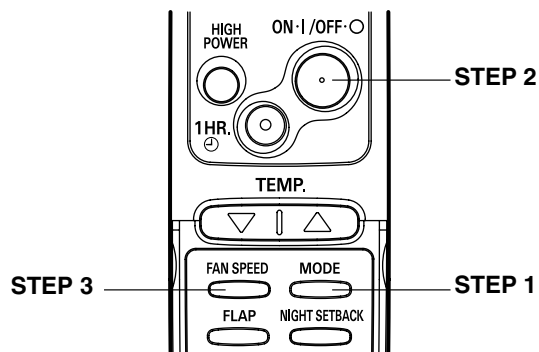

If you want to circulate air without any temperature control, follow these steps:

STEP 1	Press the MODE selector button to switch to the fan mode .
STEP 2	Press the ON/OFF operation button.
STEP 3	Press the FAN SPEED selector button to select the fan speed of your choice (, , or).

NOTE

- There is no FAN only function at M of the S/M switch on the remote control unit.

5. Night Setback Mode

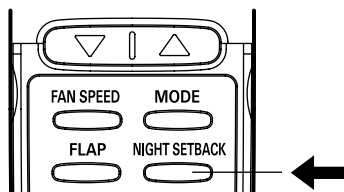
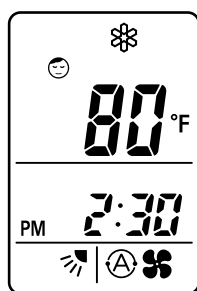

Night Setback Mode is used for saving energy.

Press the NIGHT SETBACK button while operation. The mark appears in the display.

To release the night setback function, press the NIGHT SETBACK button again.

A. In Cooling and DRY Mode: (and)

When the night setback mode is selected, the air conditioner automatically raises the temperature setting 2 °F when 30 minutes have passed after the selection was made, and then another 2 °F after another 30 minutes have passed, regardless of the indoor temperature when night setback was selected. This enables you to save energy without sacrificing comfort. This function is convenient when gentle cooling is needed.

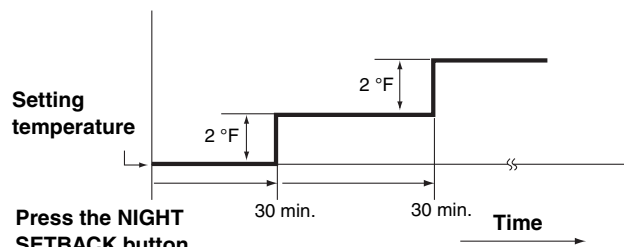

B. In Heating Mode: ()

When the night setback mode is selected, the air conditioner automatically lowers the temperature setting 4 °F when 30 minutes have passed after the selection was made, and then another 4 °F after another 30 minutes have passed, regardless of the indoor temperature when night setback was selected. This enables you to save energy without sacrificing comfort. This function is convenient when gentle heating is needed.

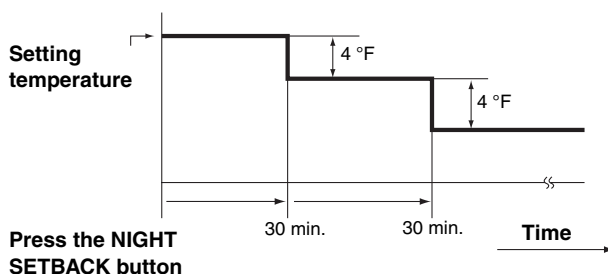

6. HIGH POWER Mode

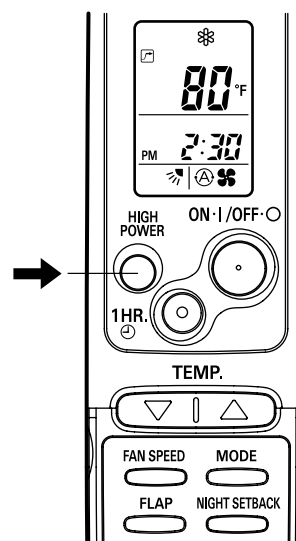

HIGH POWER mode can be used to increase the output of the indoor unit for all operation modes except automatic operation.

Press the HIGH POWER button while operation. The mark appears in the display.

To cancel, press HIGH POWER button again.

- When the HIGH POWER button is pressed, the unit operates at maximum output for 30 minutes, regardless of the desired temperature. The fan speed is 1 step above “High”.
- HIGH POWER Mode cannot be used when the operation mode is Automatic Operation.

NOTE

- When set to High fan speed during heating operation, the fan runs at High fan speed even though the  mark is displayed.
- Depending on the operating conditions, the fan speed may be increased by a small amount only.

SPECIAL REMARKS

“DRY” () Operation

How it works?

- Once the room temperature reaches the level that was set, the unit’s operation frequency is changed automatically.
- During DRY operation, the fan speed automatically runs at lower speed for providing a comfortable breeze.
- “DRY” operation is not possible if the indoor temperature is 59 °F or less.

Heating () Operation

Heating performance

- Because this air conditioner heats a room by drawing in the heat of the outside air (heat pump system), the heating efficiency will fall off when the outdoor temperature is very low. If sufficient heat cannot be obtained with this air conditioner, use another heating appliance together with it.

Defrosting

- When the outdoor temperature is low, frost or ice may form on the heat exchanger coil, reducing heating performance. When this happens, a microcomputer defrosting system operates. At the same time, the fan on the indoor unit stops and the OPERATION lamp lights red and orange alternately until defrosting is completed. Heating operation restarts after several minutes. (This interval will vary slightly depending upon the outdoor temperature and the way in which frost forms.)

Cold draft prevention

- For several minutes after the start of heating operation, the indoor fan runs at a lower speed until the indoor heat exchanger coil has warmed up sufficiently. However, the fan may remain stopped when the room temperature is low. This is because the COLD DRAFT PREVENTION SYSTEM is in operation.

Cooling () operation

- Sometimes the indoor unit may not get to the set fan speed such as LOW under cool operation at very low outdoor temperatures due to the indoor unit being protected from ice or frost.

Power failure during operation

- In the event of power failure, the unit will stop. When the power is resumed, the unit will restart automatically in approximately 5 minutes, or 15 minutes at M position of the S/M switch on AUTO mode by the remote control unit.

Clicking Sound

Clicking sound is heard from the air conditioner

- In heating or cooling operation, any plastic parts may expand or shrink due to a sudden temperature change. In this event, a clicking sound may occur. This is normal, and the sound will soon disappear.

Remote Control Unit

- The remote control unit sends the setting condition to the air conditioner regularly at five minute intervals.

SETTING THE TIMER

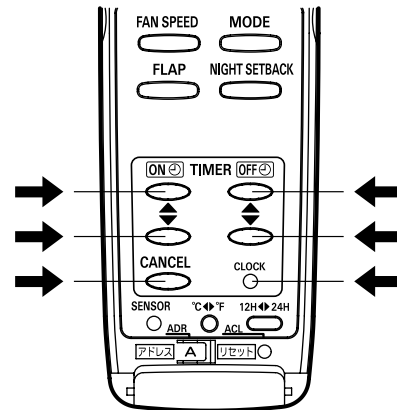

NOTE

In the descriptions below, the following settings are used for the temperature and time indicator selector button on the bottom front section of the remote control unit.

- Temperature: °F
- Time: AM, PM

1. How to set the present time

(Example) To set to 10:30 pm.

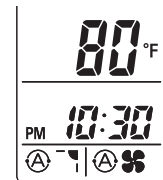
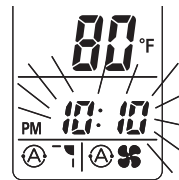

Operation	Indication
1. Press the CLOCK button once if the time indicator is not flashing.	The time indication alone flashes.
2. Press the Advance, Return (▲, ▼) button until PM 10:30 is displayed.	The time can be set in 1-minute increments. Holding down the button advances the time rapidly in 10-minute increments.
3. Press the CLOCK button again.	This completes the setting of the current time.

2. How to set the OFF time

(Example) To stop the air conditioner at 11:00 am.

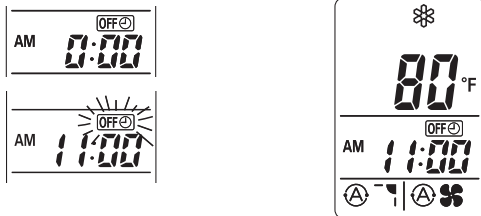

Operation	Indication
1. Press the OFF TIME setting button once.	The timer OFF indication is displayed, and the present OFF time is shown.
2. Press the Advance, Return (▲ , ▼) button until AM 11:00 is displayed.	The timer OFF indication blinks. The time can be set in 10-minute increments. Holding down the button advances the time rapidly in 10-minute increments.
3. Wait a few seconds, and then the setting is complete.	The timer OFF indication stops blinking and the present time is displayed.

3. How to set the ON time

(Example) To start operation at 7:10 am.

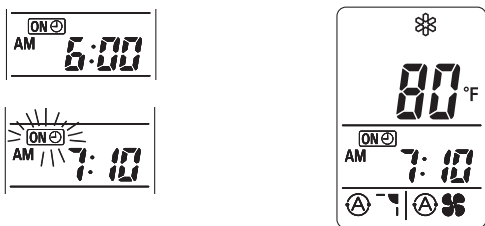

Operation	Indication
1. Press the ON TIME setting button once.	The timer ON indication is displayed, and the present ON time is shown.
2. Press the Advance, Return (▲ , ▼) button until AM 7:10 is displayed.	The timer ON indication blinks. The time can be set in 10-minute increments. Holding down the button advances the time rapidly in 10-minute increments.
3. Wait a few seconds, and then the setting is complete.	The timer ON indication stops blinking and the present time is displayed.

4. How to set daily ON/OFF repeat timer

(Example) To start operation at 7:10 am. and stop the air conditioner at 11:00 am.

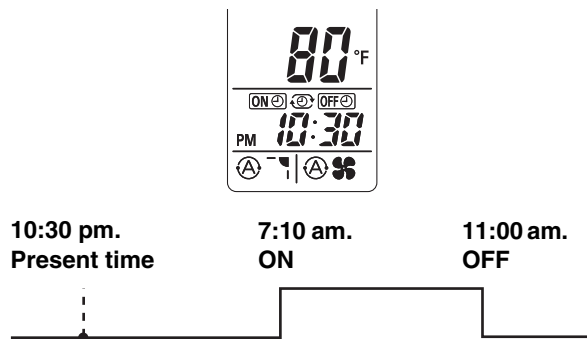

Operation	Indication
1. Set the timer ON/OFF times as shown in 2-1, 2, 3 and 3-1, 2, 3.	The present time 10:30 pm. and ON OFF are displayed.

NOTE

- The ON/OFF combination timer uses the current time as the reference, and it is activated starting from whichever set time comes first.
- With the ON/OFF combination timer, the settings are repeated every day.
- You can check the timer ON/OFF times after you have set them by pressing the ON TIME and OFF TIME setting buttons.

To cancel a timer program

- Press the CANCEL button.
- When either an ON or OFF timer is to be canceled, press the button corresponding to the timer whose program is to be canceled, and then press the CANCEL button.

NOTE

- The airflow direction, fan speed and temperature setting can be changed after a timer program has been set even when the unit is stopped. Even when operation is stopped during an ON timer program, the unit will start operating when the set time is reached provided that the program is not canceled.
- When the ON timer and OFF timer are set to the same time, the timer operates as if it is turned off.

USING THE 1-HOUR OFF TIMER

1. 1-Hour OFF Timer

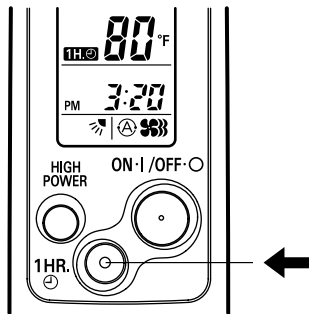

This function causes the unit to operate for one hour and then stop, regardless of whether the unit is on or off when this button is pressed.

The **1HR.** indicator in the display indicates that this function is operating.

Setting procedure:

Regardless of whether the unit is operating or stopped, press the 1 HR. TIMER button.

1HR. appears in the display.

Cancellation procedure:

Press the ON/OFF operation button to turn the unit off, wait for the unit to stop operating, and then press the ON/OFF operation button again.

The 1-Hour Timer function is now cancelled and the unit operates normally.

NOTE

- If, while the 1-Hour Timer function is operating, the 1HR. TIMER button is pressed once to cancel the function and then again, the unit continues to operate for one hour from that point in time and then stops.
- It is not possible to use the OFF Timer and 1-Hour OFF Timer together. Whichever function is set last takes precedence. If the 1 HR. TIMER button is pressed while the TIMER OFF function operates, the OFF Timer is cancelled and the unit will stop operating one hour later.

2. Operation together with the daily ON/OFF repeat timer

The 1-Hour OFF Timer setting is given priority over the DAILY ON/OFF REPEAT setting.

TIPS FOR ENERGY SAVING

Do not

- **Block the air intake and outlet of the unit. If they are obstructed, the unit will not work well, and may be damaged.**
- Let direct sunlight into the room. Use sunshades, blinds or curtains. If the walls and ceiling of the room are warmed by the sun, it will take longer to cool the room.

Do

- Always try to keep the air filter clean. (Refer to "CARE AND CLEANING".) A clogged filter will impair the performance of the unit.
- To prevent conditioned air from escaping, keep windows, doors and any other openings closed.

ADJUSTING THE AIRFLOW DIRECTION

The vertical airflow can be adjusted by moving the flap with the remote control unit. Do not move the flap with your hands. Confirm that the remote control unit has been turned on. Use the FLAP button to set either the sweep function or one of the six airflow direction settings.

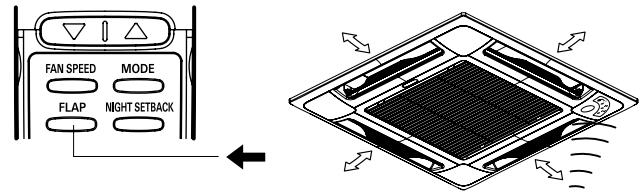

A. Sweep function



The flap starts moving up and down to deliver air over the sweep range.

B. Setting the airflow manually



Referring to the above illustration, use the FLAP button to set the airflow direction within the range used during the heating, cooling, or dehumidifying operation.

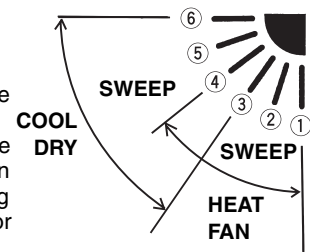

C. Auto flap function



The flap is set to the recommended position.

NOTE

- The flap automatically closes when the unit is off.
- During the heating operation, the fan speed will be very low and the flap will be in the horizontal position (position ⑥) until the air being blown out of the unit begins to warm. Once the air warms up, the flap position and fan speed change to the settings specified with the remote control unit.



CAUTION

- Use the FLAP button on the remote control unit to adjust the position of the flap. If you move the flap by hand, the flap position according to the remote control unit and the actual flap position may no longer match. If this should happen, shut off the unit, wait for the flap to close, and then turn on the unit again; the flap position will now be normal again.
- Do not have the flap pointed down during cooling operation. Condensation may begin to form around the air vent and drip down.

OPERATION WITHOUT THE REMOTE CONTROL UNIT

INDOOR UNIT

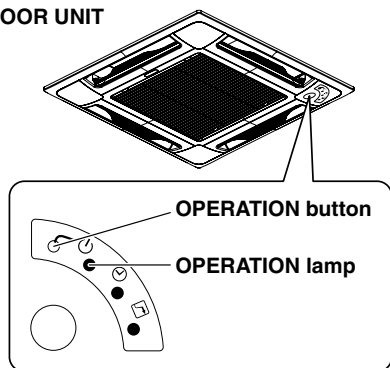

If you have lost the remote control unit or it has trouble, follow the steps below.

When the air conditioner is not running

Each time the OPERATION button is pressed, the type of operation conducted is indicated by the changing color of the OPERATION lamp. Press the button and select the lamp color that suits your preference for operation.



NOTE

The temperature is set to the room temperature minus 4°F during the cooling operation and to the room temperature plus 4°F during the heating operation, and the fan speed and flap are set to Auto.

CARE AND CLEANING



WARNING

- Cleaning and maintenance operations must be carried out by specially trained personnel. While working in high places, slipping or falling may result in serious injury.
- For safety, be sure to turn the air conditioner off and also to disconnect the power before cleaning.
- Do not pour water on the indoor unit to clean it. This will damage the internal components and cause an electric shock hazard.

Ceiling panel (Indoor Unit)

Clean the ceiling panel of the indoor unit with a vacuum cleaner brush, or wipe it with a clean, soft cloth.

If it is stained, use a clean cloth moistened with a mild liquid detergent. When cleaning it, be careful not to force the flaps out of place.



CAUTION

- Never use solvents, or harsh chemicals when cleaning the indoor unit. Do not wipe the plastic casing using very hot water.
- Some metal edges and the fins are sharp and may cause injury if handled improperly; be especially careful when you clean these parts.
- The internal coil and other components of the outdoor unit must be cleaned every year. Consult your dealer or service center.

Cleaning the flaps

- The air outlet flap can be removed and washed with water.
- Be sure to always stop operation before removing the flap.
- After washing with water, allow it to dry, and then remount it.

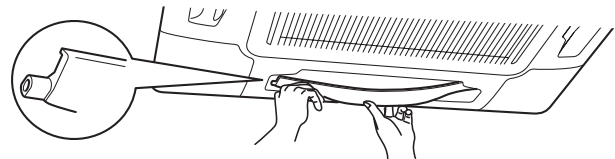

CAUTION

- Do not move the flap with your hands.
- When using a footstool or the like, be careful not to let it tip over.

Cleaning the main unit and remote control unit

- Wipe clean using a soft, dry cloth.
- To remove stubborn dirt, moisten a cloth in warm water no hotter than 104 °F, wring thoroughly, and then wipe.

Air filter

The air filter collects dust and other particles from the air and should be cleaned once every 6 months.

If the filter gets blocked, the efficiency of the air conditioner drops greatly.

NOTE

The frequency with which the filter should be cleaned depends on the environment in which the unit is used.

How to remove the filter

1. Slide the two latches of the air intake grille with your thumbs in the direction of the arrow to open the grille.

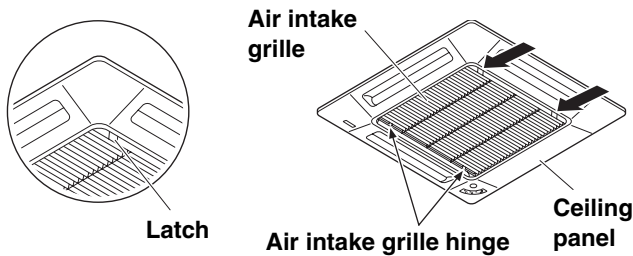

2. Open the air intake grille downward.



3. Press the tabs on both sides of the air filter (indicated with ◁ marks on the grill) to release the filter, and then, lift and pull the filter up and out using the tabs to remove it.

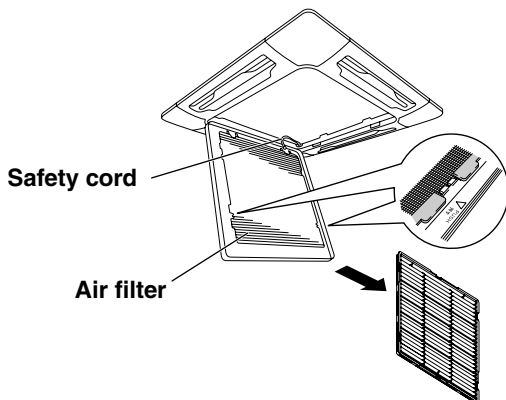

4. Use a vacuum cleaner to remove light dust. If there is sticky dust on the filter, wash the filter in lukewarm, soapy water, rinse it in clean water, and dry it.
5. Insert the filter correctly again inside the grille, close the grille letting the latches slide towards the outside and fix again the latch.

How to remove the air intake grille

1. Open the air intake grille.
2. Detach the safety cord from the frame (remember to attach it again after cleaning or maintenance).
3. Hold on the air intake grille and pull it towards you to detach the two air intake grille hinges.
4. Clean the grille gently using a soft sponge, or the like. Then dry it with care.
Neutral detergent may be used to remove stubborn dirt. Then rinse thoroughly with water and dry it.

Air intake grille hinge

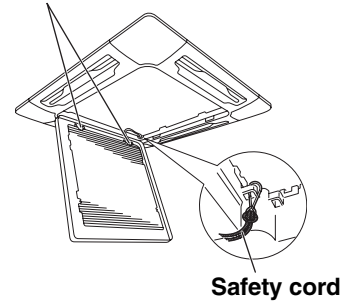

CAUTION

- When cleaning the air filter, never remove the safety cord. If it is necessary to remove it for servicing and maintenance inside, be sure to reinstall the safety cord securely (hook on the grille side) after the work.
- When the air intake grille has been opened, rotating parts (such as the fan), electrically charged areas, etc. will be exposed in the unit's opening. Bear in mind the dangers that these parts and areas pose, and proceed with the work carefully.
- Periodically check the outdoor unit to see if the air outlet or air intake is clogged with dirt or soot.

Care: After a prolonged idle period

Check the indoor and outdoor unit air intakes and outlets for blockage; if there is a blockage, remove it.

Care: Before a prolonged idle period

- Operate the fan for half a day to dry out the inside.
- Disconnect the power supply and also turn off the circuit breaker.
- Clean the air filter and replace it in its original position.
- Outdoor unit internal components must be checked and cleaned periodically.
Contact your local dealer for this service.

TROUBLESHOOTING

If your air conditioner does not work properly, first check the following points before requesting service. If it still does not work properly, contact your dealer or service center.

Trouble	Possible Cause	Remedy
Air conditioner does not run at all.	<ol style="list-style-type: none"> 1. Power failure. 2. Leakage circuit breaker tripped. 3. Line voltage is too low. 4. Batteries in remote control unit have run down. 	<ol style="list-style-type: none"> 1. Restore power. 2. Contact service center. 3. Consult your electrician or dealer. 4. Replace batteries.
OPERATION lamp blinks and air conditioner does not operate.	Trouble in system.	Contact service center.
Compressor runs but soon stops.	Obstruction in front of condenser coil.	Remove obstruction.
Poor cooling (or heating) performance.	<ol style="list-style-type: none"> 1. Dirty or clogged air filter. 2. Heat source or many people in room. 3. Doors and/or windows are open. 4. Obstacle near air intake or air discharge port. 5. Thermostat is set too high for cooling (or too low for heating). 6. (Outdoor temperature is too low for heating.) 	<ol style="list-style-type: none"> 1. Clean air filter to improve airflow. 2. Eliminate heat source if possible. 3. Shut them to keep the heat (or cold) out. 4. Remove it to ensure good airflow. 5. Set the temperature lower (or higher). 6. (Consult your dealer or try to use another heat appliance.)
Clicking sound is heard from the air conditioner.	In heating or cooling operation, any plastic parts may expand or shrink due to a sudden temperature change. In this event, a clicking sound may occur.	This is normal, and the sound will soon disappear.
OPERATION lamp lights but outdoor unit will not run.	The use of cellular phones near the air conditioner may cause disturbance to its normal operation.	<ol style="list-style-type: none"> 1. Turn off the power then restart the air conditioner after a while. 2. Consult your dealer.
TIMER lamp blinks (3 sec. interval) and air conditioner does not operate.	FLOAT SWITCH is actived.	Contact service center.

OPERATING RANGE

The air conditioner is operable within the temperature ranges as listed below:

	Temperature	Indoor air temperature	Outdoor air temperature
COOLING	Max.	95 °F DB / 71 °F WB	115 °F DB
	Min.	67 °F DB / 57 °F WB	For Single use 0 °F DB For Multiple use 67 °F DB
HEATING	Max.	80 °F DB / 67 °F WB	75 °F DB / 65 °F WB
	Min.	- DB / - WB	0 °F DB

WIRED REMOTE CONTROLLER

A separately sold wired remote controller (STK-RCS-7TWSU, 7TWSUA) used with this air conditioner is also available. If you wish to use the wired remote control function, you will need to purchase the optional wired remote controller.

APPENDIX C INSTALLATION INSTRUCTIONS

XMHS0972 & PNR-XS1872
XMHS1272 & PNR-XS1872
XHS1872 & PNR-XS1872

(II-852-6-4190-493-00-0)

– Inverter Split System Air Conditioner – COOL/DRY/HEAT Model

This air conditioner uses the new refrigerant R410A.

NOTE Refrigerant service valve size = 5/16"

Contents

	Page
IMPORTANT!	
Please Read Before Starting	2
1. GENERAL	3
1-1. Tools Required for Installation (not supplied)	
1-2. Accessories Supplied with Unit	
1-3. Optional Copper Tubing Kit	
1-4. Type of Copper Tube and Insulation Material	
1-5. Additional Materials Required for Installation	
2. INSTALLATION SITE SELECTION	4
2-1. Indoor Unit	
2-2. Embedding the Tubing and Wiring	
3. HOW TO INSTALL THE INDOOR UNIT	6
3-1. Preparation for Suspending	
3-2. Suspending the Indoor Unit	
3-3. Placing the Unit Inside the Ceiling	
3-4. Installing the Drain Piping	
3-5. Checking the Drainage	
3-6. How to Install the Ceiling Panel	
3-7. Wiring Instructions	
3-8. Wiring Instructions for Inter-unit Connections	
4. HOW TO TEST RUN THE AIR CONDITIONER	13
5. REMOTE CONTROL UNIT INSTALLATION POSITION	14
5-1. Mounting on a Wall	
6. ADDRESS SWITCH	15
6-1. Address Setting of the Remote Control Unit	
7. CONNECTING A HOME AUTOMATION DEVICE	16
8. INSTALLATION CHECK SHEET	16

Model Combinations

Combine indoor and outdoor units only as listed below.

<u>Indoor Unit</u>		<u>Outdoor Unit</u>
XMHS0972	\	CMH1972
XMHS1272	/	CMH2472
XHS1872	\	CMH3172

Power Source:
60 Hz, single-phase, 230 / 208 VAC

Ceiling Panel
PNR-XS1872



Be sure to connect indoor and outdoor units only in combinations that are listed in the combination table(s) included in the outdoor unit package. Connecting any other model may result in operation failure and malfunction.

Be sure to read the yellow instruction sheet attached to the outdoor unit for models using the new refrigerant R410A.

NOTE

The illustrations are based on the typical appearance of a standard model. Consequently, the shape may differ from that of the air conditioner that you are installing.

SANYO North America Corporation
Commercial Solutions Division
2055 Sanyo Ave., San Diego
CA 92154, U.S.A.

In Canada
SANYO Canada Inc.
201 Creditview Road, Woodbridge
Ontario, L4L 9T1, Canada

IMPORTANT!

Please Read Before Starting

This air conditioning system meets strict safety and operating standards. As the installer or service person, it is an important part of your job to install or service the system so it operates safely and efficiently.

For safe installation and trouble-free operation, you must:

- Carefully read this instruction booklet before beginning.
- Follow each installation or repair step exactly as shown.
- Observe all local, state, and national electrical codes.
- Pay close attention to all warning and caution notices given in this manual.



WARNING

This symbol refers to a hazard or unsafe practice which can result in severe personal injury or death.



CAUTION

This symbol refers to a hazard or unsafe practice which can result in personal injury or product or property damage.

If Necessary, Get Help

These instructions are all you need for most installation sites and maintenance conditions. If you require help for a special problem, contact our sales/service outlet or your certified dealer for additional instructions.

In Case of Improper Installation

The manufacturer shall in no way be responsible for improper installation or maintenance service, including failure to follow the instructions in this document.

SPECIAL PRECAUTIONS

WARNING When Wiring



ELECTRICAL SHOCK CAN CAUSE SEVERE PERSONAL INJURY OR DEATH. ONLY A QUALIFIED, EXPERIENCED ELECTRICIAN SHOULD ATTEMPT TO WIRE THIS SYSTEM.

- Do not supply power to the unit until all wiring and tubing are completed or reconnected and checked.
- Highly dangerous electrical voltages are used in this system. Carefully refer to the wiring diagram and these instructions when wiring. Improper connections and inadequate grounding can cause **accidental injury or death**.
- **Ground the unit** following local electrical codes.
- Connect all wiring tightly. Loose wiring may cause overheating at connection points and a possible fire hazard.

When Transporting

Be careful when picking up and moving the indoor and outdoor units. Get a partner to help, and bend your knees when lifting to reduce strain on your back. Sharp edges or thin aluminum fins on the air conditioner can cut your fingers.

When Installing...

...In a Ceiling or Wall

Make sure the ceiling/wall is strong enough to hold the unit's weight. It may be necessary to construct a strong wood or metal frame to provide added support.

...In a Room

Properly insulate any tubing run inside a room to prevent "sweating" that can cause dripping and water damage to walls and floors.

When Connecting Refrigerant Tubing

- Do not add any refrigerant, air, or substance into the refrigeration circuit other than the designated refrigerant (R410A). Adding anything other than the specified refrigerant may cause the pressure to rise excessively in the refrigeration circuit, rupturing the circuit and causing injury or damage.
- Use all-new tubing and flare nuts to make the tubing connections. Using any previous parts (from R22-based systems) may result in damage to the equipment, and may lead to the refrigeration circuit rupturing, causing a serious accident.
- Apply refrigerant lubricant to the matching surfaces of the flare and union tubes before connecting them, then tighten the nut with a torque wrench for a leak-free connection.
- Check carefully for leaks before starting the test run.

When Servicing

- Turn the power OFF at the main power box (mains) before opening the unit to check or repair electrical parts and wiring.
- Keep your fingers and clothing away from any moving parts.
- Clean up the site after you finish, remembering to check that no metal scraps or bits of wiring have been left inside the unit being serviced.



CAUTION

Others

- Ventilate any enclosed areas when installing or testing the refrigeration system. Escaped refrigerant gas, on contact with fire or heat, can produce dangerously toxic gas.
- Confirm upon completing installation that no refrigerant gas is leaking. If escaped gas comes in contact with a stove, gas water heater, electric room heater or other heat source, it can produce dangerously toxic gas.

1. General











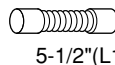

This booklet briefly outlines where and how to install the air conditioning system. Please read over the entire set of instructions for the indoor and outdoor units and make sure all accessory parts listed are with the system before beginning.

1-1. Tools Required for Installation (not supplied)

- | | | |
|------------------------------|------------------------------|----------------------------|
| 1. Standard screwdriver | 6. Sabre saw or key hole saw | 11. Tube cutter |
| 2. Phillips head screwdriver | 7. Hacksaw | 12. Tube flaring tool |
| 3. Knife or wire stripper | 8. Core bits | 13. Torque wrench |
| 4. Tape measure | 9. Hammer | 14. Adjustable wrench |
| 5. Carpenter's level | 10. Drill | 15. Reamer (for deburring) |

1-2. Accessories Supplied with Unit

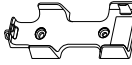
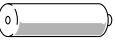
Table 1

Parts	Figure	Q'ty	Remarks	Parts	Figure	Q'ty	Remarks
Washer		8	For temporarily suspending indoor unit from ceiling	Truss head screw	 3/16×13/32" (5×10mm)	4	For full-scale installation diagram
Flare insulation	 1/8"(T3) 3/16"(T5)	2 set	For wide / narrow tube connection	Drain hose	 5-1/2"(L140)	1	For unit & PVC tube connection
Insulation tape	 3/32"(T2)	2	For wide / narrow tube / flare nut connection	Hose band		2	For drain hose connection
Vinyl tie		8	For flare / drain insulating connection	Tapping screw	Truss-head Phillips 5/32×5/8" (4×16mm) 	2	
Drain hose insulation	 13/32"(T10)	1	For drain tube connection	Truss head screw	 5/32×15/32" (4×12mm)	4	Packed in the ceiling panel
Remote control unit		1		Special screw	 3/16×1-9/16" (5×40mm)	4	
Remote control unit holder		1		<ul style="list-style-type: none"> • Use M10 or 3/8" for suspension bolts. • Suspension bolts and nuts (locally purchased) 			
AAA alkaline battery		2					
Full-scale installation diagram		1	Printed on container box				

1-3. Optional Copper Tubing Kit

Copper tubing for connecting the outdoor unit to the indoor unit is available in kits which contain the narrow and wide tubing, fittings and insulation. Consult your nearest sales outlet or air conditioning workshop.

1-4. Type of Copper Tube and Insulation Material

If you wish to purchase these materials separately from a local source, you will need:

- Deoxidized annealed copper tube for refrigerant tubing as detailed in Table 2.
Cut each tube to the appropriate lengths 1' to 1'4" (30 cm to 40 cm) to dampen vibration between units.
- Foamed polyethylene insulation for the specified copper tubes as required to precise length of tubing. Wall thickness of the insulation should be not less than 5/16" (8 mm).
- Use insulated copper wire for field wiring. Wire size varies with the total length of wiring. Refer to 3-7. Wiring Instructions for details.

Table 2

Model	Narrow Tube		Wide Tube	
	Outer Dia.	Thickness	Outer Dia.	Thickness
XMHS0972/1272	1/4" (6.35 mm)	0.0314" (0.8 mm)	3/8" (9.52 mm)	0.0314" (0.8 mm)
XHS1872	1/4" (6.35 mm)	0.0314" (0.8 mm)	1/2" (12.70 mm)	0.0314" (0.8 mm)



CAUTION

Check local electrical codes and regulations before obtaining wire. Also, check any specified instructions or limitations.

1-5. Additional Materials Required for Installation

1. Refrigeration (armored) tape
2. Insulated staples or clamps for connecting wire
(See local codes.)
3. Putty
4. Refrigeration lubricant
5. Clamps or saddles to secure refrigerant tubing

2. Installation Site Selection

2-1. Indoor Unit



WARNING

To prevent abnormal heat generation and the possibility of fire, do not place obstacles, enclosures and grilles in front of or surrounding the air conditioner in a way that may block air flow.

AVOID:

- direct sunlight.
- nearby heat sources that may affect performance of the unit.
- areas where leakage of flammable gas may be expected.
- placing or allowing any obstructions near the air conditioner inlet or outlet.
- installing in rooms that contain instant-on (rapid-start) fluorescent lamps. (These may prevent the air conditioner from receiving signals.)
- places where large amounts of oil mist exist.
- installing in locations where there are devices that generate high-frequency emissions.

DO:

- select an appropriate position from which every corner of the room can be uniformly cooled.
- select a location that will hold the weight of the unit.
- select a location where tubing and drain hose have the shortest run to the outside.
- allow room for operation and maintenance as well as unrestricted air flow around the unit. (Fig. 1)
- install the unit within the maximum elevation difference (H1, H2, H3, H4) above or below the outdoor unit and within a total tubing length ($L1+L2+L3$, $L1+L2+L3+L4$) from the outdoor unit as detailed in Table 3 and Fig. 2.

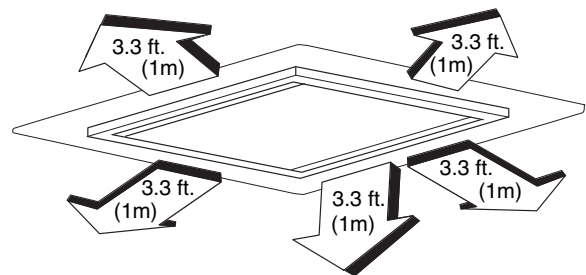

Fig. 1

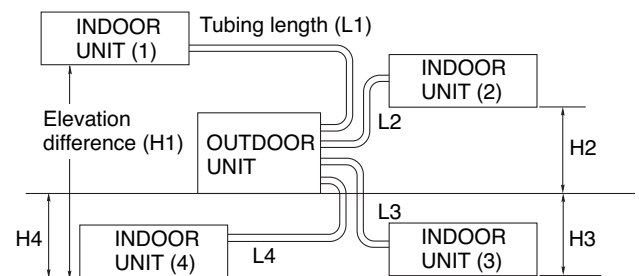

Fig. 2



CAUTION

Air delivery will be degraded if the distance from the floor to the ceiling is greater than 10 ft. (3 m).

- Install the indoor unit more than 3.3' (1 m) away from any antenna or power lines or connecting wires used for television, radio, telephone, security system, or intercom. Electrical noise from any of these sources may affect operation.
- install in a sturdy manner to avoid increased operating noise.

Table 3

Model	Max. Allowable Tubing Length per unit (ft.)	Max. Allowable Total Tubing Length at shipment (L1+L2+L3) or (L1+L2+L3+L4) (ft.)	Limit of Total Tubing Length (L1+L2+L3) or (L1+L2+L3+L4) (ft.)	Limit of Elevation Difference (H1, H2, H3, H4) (ft.)	Required Amount of Additional Refrigerant (oz./ft.)*
CMH1972	82	150 (L1+L2+L3)	150 (L1+L2+L3)	50	—
CMH2472	82	150 (L1+L2+L3+L4)	200 (L1+L2+L3+L4)	50	0.22
CMH3172	100	150 (L1+L2+L3+L4)	230 (L1+L2+L3+L4)	50	0.22

* If total tubing length becomes 150 to 200 ft. (Max.) or 150 to 230 ft. (Max.), charge additional refrigerant (R410A) by 0.22 oz./ft. No additional charge of compressor oil is necessary. For more detailed charging information, refer to the Technical & Service Manual.

2-2. Embedding the Tubing and Wiring

- Before beginning embedding installation work, consult fully with agencies or offices related to the building's foundation, construction, electricity, and water.
- Wait to make connections to the embedded portion. Each connection step is described later in this manual.
- Securely cover the end of the embedded tubing to prevent intrusion of dirt or moisture.
- If an embedded tube is to be left for a long time, fill the tube with nitrogen and seal both ends securely. If a tube is left open for an extended time, moisture in the air inside the tubing may condense into water droplets, and lead to water contamination of the refrigerant circuit.
- In order to prevent insulation breakdown and ground faults, do not allow wiring ends to come in contact with rainwater, or be subjected to condensation or dew.
- Apply sufficient thermal insulation to the refrigerant tubing and drain pipes.

3. How to Install the Indoor Unit

3-1. Preparation for Suspending

This unit uses a drain pump. Use a carpenter's level to check that the unit is level.

3-2. Suspending the Indoor Unit

- (1) Fix the suspension bolts securely in the ceiling using the method shown in the diagrams, by attaching them to the ceiling support structure, or by any other method that ensures that the unit will be securely and safely suspended. (Fig. 6-1)
- (2) Follow the diagram to make the holes in the ceiling.
- (3) Determine the pitch of the suspension bolts using the supplied full-scale installation diagram. The diagram shows the relationship between the positions of the suspension fitting, unit, and panel. (Fig. 6-2)

3-3. Placing the Unit Inside the Ceiling

- (1) Be sure to remove the fan protection (4pcs) for transportation before hanging up the indoor unit.
- (2) When placing the unit inside the ceiling, determine the pitch of the suspension bolts using the supplied full-scale installation diagram. (Fig. 6-3)
Tubing and wiring must be laid inside the ceiling when suspending the unit. If the ceiling is already constructed, lay the tubing and wiring into position for connection to the unit before placing the unit inside the ceiling.
- (3) The length of suspension bolts must be appropriate for a distance between the bottom of the bolt and the bottom of the unit of more than 19/32" (15 mm) as shown in the diagram. (Fig. 6-3)
- (4) Thread the 3 hexagonal nuts (locally purchased) and 2 supplied washers onto each of the 4 suspension bolts as shown in the diagram. Use 1 nut and 1 washer for the upper side, and 2 nuts and 1 washer for the lower side, so that the unit will not fall off the suspension lugs. (Fig. 6-4)
- (5) Adjust so that the distance between the unit and the ceiling bottom is 1/2" (13 mm) to 23/32" (18 mm). Tighten the nuts on the upper side and lower side of the suspension lug. (Fig. 6-4)

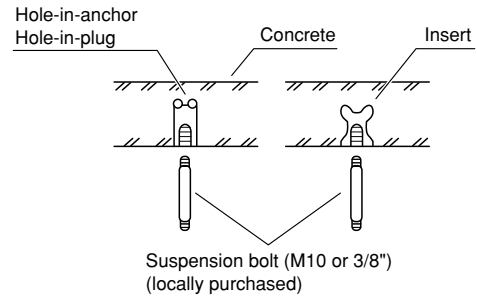

Fig. 6-1

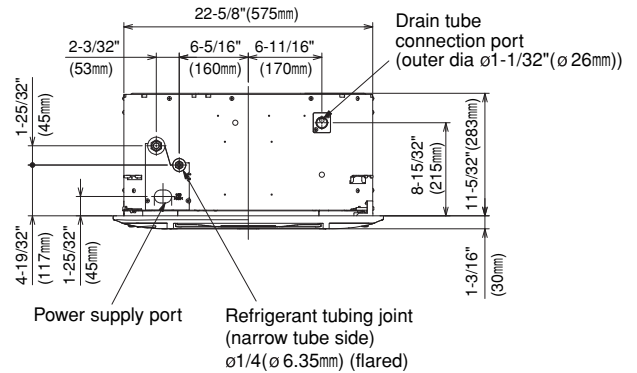
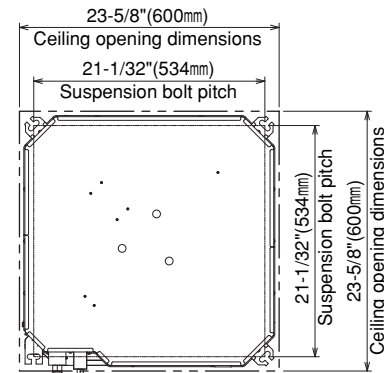

Fig. 6-2

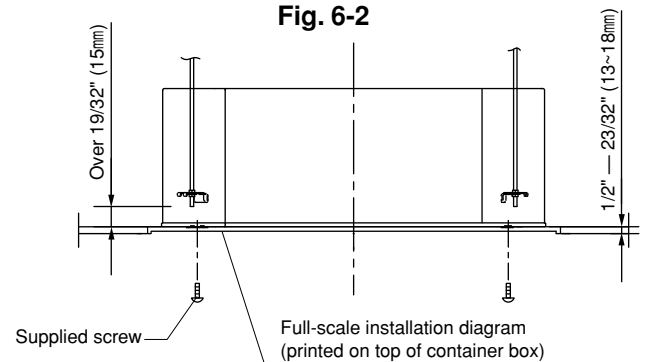

Fig. 6-3

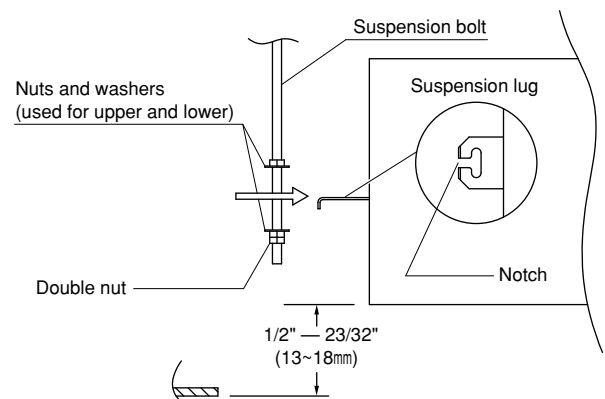

Fig. 6-4

3-4. Installing the Drain Piping

- (1) Prepare standard hard PVC pipe (locally purchased O.D. 1-1/32" (26 mm)) for the drain and use the supplied hose band to prevent water leaks. (Fig. 6-5)
- (2) To install the drain hose, first place 1 of the 2 hose bands over the unit drain port and the other hose band over the hard PVC pipe (not supplied). Then connect both ends of the supplied drain hose. (Fig. 6-5)
- (3) On the unit drain side, grasp the hose band with pliers and insert the drain hose all the way to the base.
 - If other commercially available hose bands are used, the drain hose may become pinched or wrinkled and there is danger of water leakage. Therefore be sure to use the supplied hose bands. When sliding the hose bands, be careful to avoid scratching the drain hose.
 - Do not use adhesive when connecting the supplied drain hose to the drain port (either on the main unit or the PVC pipe).
 - Reasons: a) It may cause water to leak from the connection. Since the connection is slippery just after the adhesive has been applied, the pipe easily slips off.
 - b) The pipe cannot be removed when maintenance is needed.
- (4) Wrap the hose with the supplied drain hose insulation and use the 4 twist ties so that the hose is insulated with no gaps.
 - Do not bend the supplied drain hose 90° or more. The hose may slip off.

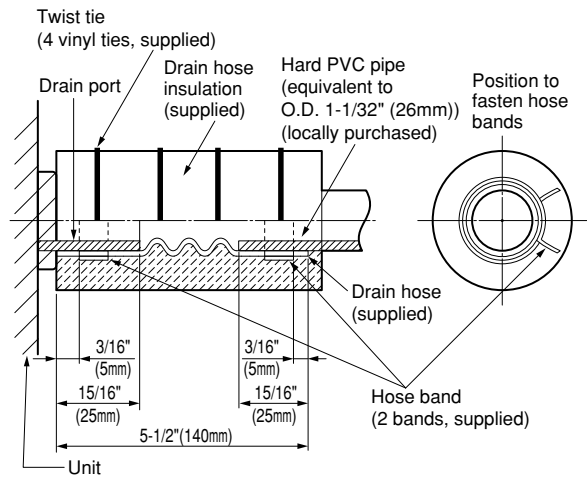

Fig. 6-5



CAUTION

- Attach so that the hose band fastener is on the side of the drain port.
- Attach the hose bands so that each is approximately 3/16" (5 mm) to 15/16" (25 mm) from the end of the supplied drain hose.

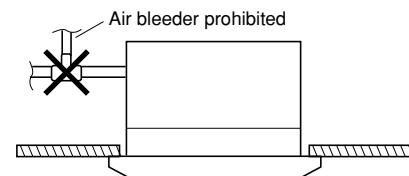

Fig. 6-6



CAUTION

- Do not install an air bleeder as this may cause water to spray from the drain pipe outlet. (Fig. 6-6)

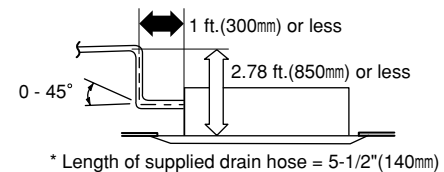

Fig. 6-7

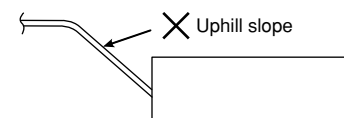

Fig. 6-8

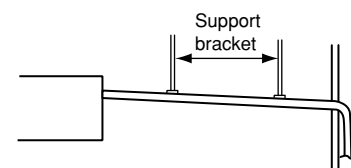

Fig. 6-9

NOTE

Make sure the drain pipe has a downward gradient (1/100 or more) and that there are no water traps.



CAUTION

- In cases where it is necessary to raise the height of the drain piping, the drain piping can be raised to a maximum height of 2.78 ft. (850 mm) above the bottom surface of the ceiling. Under no conditions attempt to raise it higher than 2.78 ft. (850 mm) above the bottom surface of the ceiling. Doing so will result in water leakage. (Fig. 6-7)
- Do not use natural drainage.
- Do not install the pipe with an upward gradient from the connection port. This will cause the drain water to flow backward and leak when the unit is not operating. (Fig. 6-8)
- Do not apply force to the piping on the unit side when connecting the drain pipe. The pipe should not be allowed to hang unsupported from its connection to the unit. Fasten the pipe to a wall, frame, or other support as close to the unit as possible. (Fig. 6-9)
- Provide insulation for any pipes that are run indoors.

3-5. Checking the Drainage

After wiring and drain piping are completed, use the following procedure to check that the water will drain smoothly. For this, prepare a bucket and wiping cloth to catch and wipe up spilled water.

- Be sure to do the wiring between the units before installing the ceiling panel. (Refer to 3-8. Wiring Instructions for Inter-unit Connections)
- (1) Turn on the power. (Here, "power" refers to the power supply from the outdoor unit.)
 - (2) Slowly pour approx. 16 ounces (500 ml) of water into the drain pan to check drainage. (Fig. 6-10a)
 - (3) Remove the 2 screws from the control box cover, then open the cover. Be careful not to drop the cover at this time.
 - (4) Disconnect the FS 3P connector (red) on the control PCB and operate the drain pump. (Fig. 6-10b) Check the water flow through the transparent drain pipe and see if there is any leakage.
 - (5) When the check of drainage is complete, reconnect the FS 3P connector and remount the control cover.

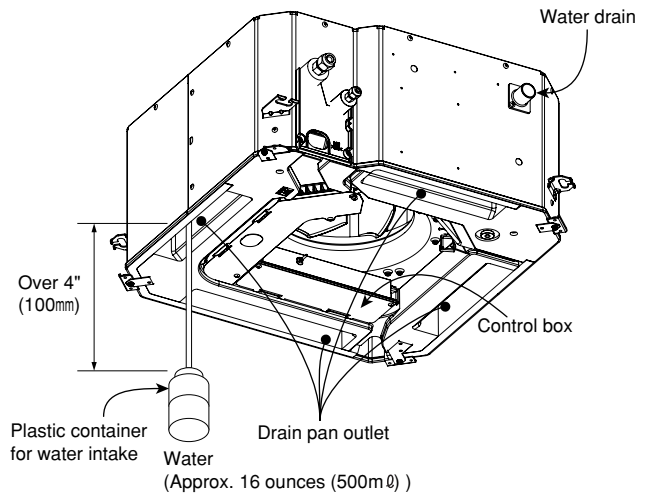

Fig. 6-10a

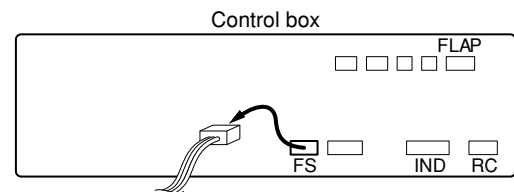

Fig. 6-10b



CAUTION

The drain pump will continue to operate for a minimum of 6 minutes after the FS 3P connector is reconnected.

- Ⓐ must be within the range of 1/2"(13mm) to 23/32"(18mm). (Fig. 6-11)
If not within this range, malfunction or other trouble may occur.

3-6. How to Install the Ceiling Panel

Checking the unit position

- (1) Check that the ceiling hole is 23-5/8" (600 mm) × 23-5/8" (600 mm) (Fig. 6-11)
- (2) Confirm that the position of the indoor unit and the ceiling as shown in the diagram. If the positions of the ceiling surface and unit do not match, air leakage, water leakage, flap operation failure, or other problems may occur. (Fig. 6-11)



CAUTION

- **Never place the panel face-down. Neither hang it vertically nor place it on top of a projecting object. Placing it face-down will damage the surface.**
- **Do not touch the flap or apply force to it. (This may cause flap malfunction.)** (Fig. 6-12)

3-6-1. Before Installing the Ceiling Panel

- (1) Remove the air-intake grille and air filter from the ceiling panel.
 - a) Press on and slide the two latches of the air-intake grille with your thumb in the direction shown by the arrow ① to open the grille. (Figs. 6-13 and 6-14)
 - b) With the air-intake grille opened, remove the grille hinge from the ceiling panel by sliding it in the direction shown by the arrow ②. (Fig. 6-15)

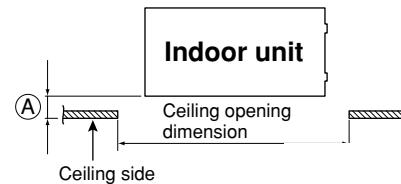

Fig. 6-11

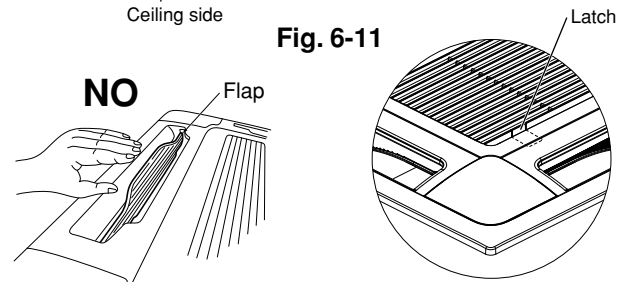

Fig. 6-12

Fig. 6-13

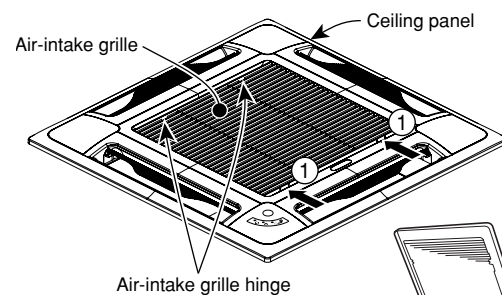

Fig. 6-14

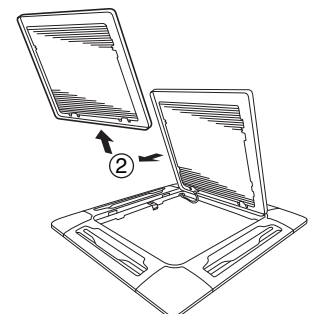

Fig. 6-15

(2) Removing the corner cover and indicator cover

a) While lightly pressing the center of the corner cover, pull up the tab for the screw hole. Use the same procedure to remove the indicator cover.

(Fig. 6-16)

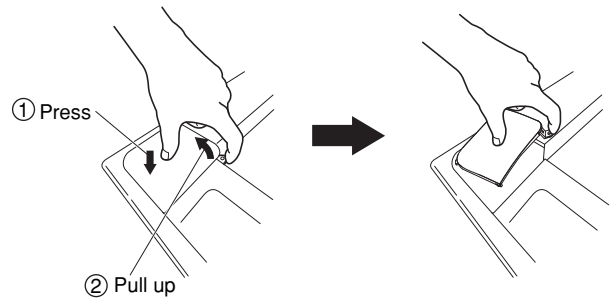
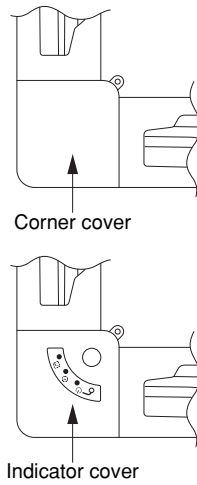

Fig. 6-16

3-6-2. Installing the Ceiling Panel

(1) Hang the temporary latches on the inside of the ceiling panel to the receptacle on the unit to temporarily attach the ceiling panel in place. (Fig. 6-17)

- The ceiling panel must be installed in the correct direction relative to the unit. Align the REF. PIPE and DRAIN marks on the ceiling panel corner with the correct positions on the unit.

(2) Align the panel installation holes and the unit screw holes. (Fig. 6-18)

(3) Tighten the supplied special screws at the 4 panel installation locations so that the panel is attached tightly to the unit.

- Check that the wiring connectors are not caught between the unit and the ceiling panel.

(4) Check that the panel is attached tightly to the ceiling. (Fig. 6-19)

- At this time, make sure that there are no gaps between the unit and the ceiling panel, or between the ceiling panel and the ceiling surface.

- If there is a gap between the panel and the ceiling, leave the ceiling panel attached and make fine adjustments to the installation height of the unit to eliminate the gap with the ceiling.

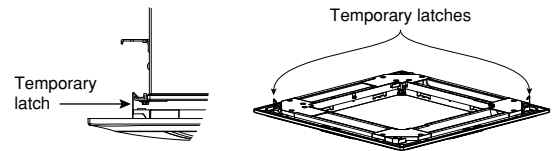

Fig. 6-17

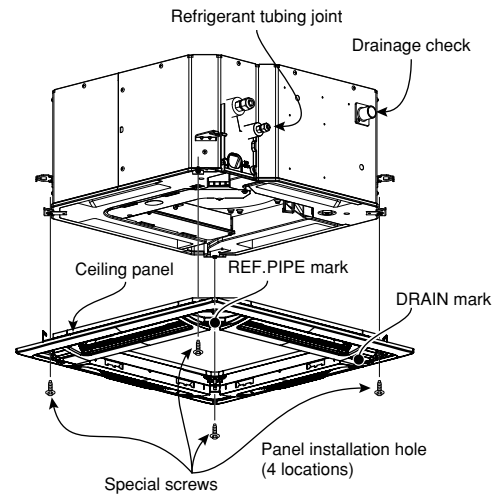

Fig. 6-18

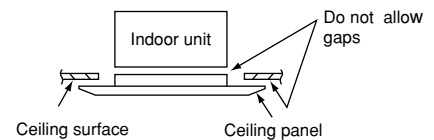

Fig. 6-19



- If the screws are not sufficiently tightened, trouble such as that shown in the figure below may occur. Be sure to tighten the screws securely.

- If a gap remains between the ceiling surface and the ceiling panel even after the screws are tightened, adjust the height of the unit again.

The height of the unit can be adjusted from the ceiling panel corner hole, with the ceiling panel attached, to an extent that does not affect the unit levelness, the drain hose, or other elements.

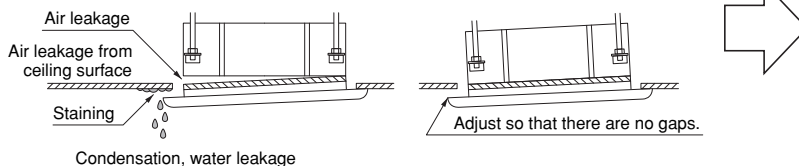
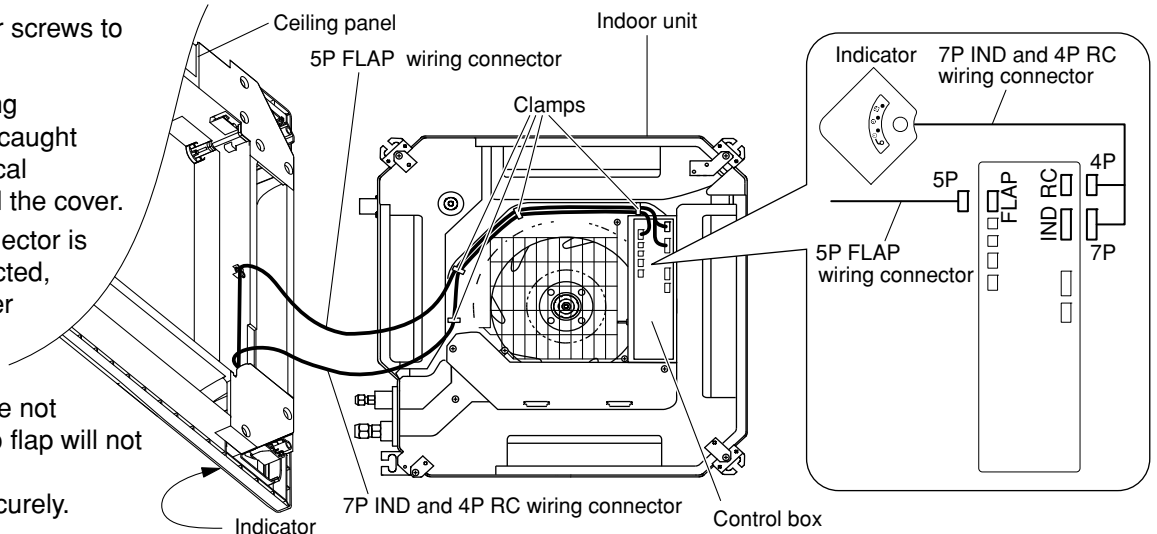

Fig. 6-20

3-6-3. Wiring the Ceiling Panel and the Indicator

- (1) Remove the 2 screws from the control box cover, then open the cover. Be careful that the cover does not fall.
- (2) Connect the 5P FLAP wiring connector from the ceiling panel to the connector on the control PCB in the control box. (Fig. 6-21)
- (3) Connect the 7P IND and 4P RC wiring connector from the indicator to the connectors on the control PCB in the control box. (Fig. 6-21)
- (4) Be sure to use the clamps to fasten the connector wires in place. (Fig. 6-21)
- (5) Tighten the 2 cover screws to close the cover.

- Check that the wiring connectors are not caught between the electrical component box and the cover.
- If the indicator connector is not securely connected, the remote controller signal will not be received.
- If the connectors are not connected, the auto flap will not operate. Be sure to connect them securely.



* Pass the wiring connectors through the clamps to fasten them in place, as shown in the figure.

Fig. 6-21

3-6-4. How to Attach the Corner Cover and Air-Intake Grille

A. Attaching the corner cover

- (1) Check that the safety strap from the corner cover is fastened to the ceiling panel pin, as shown in the figure. (Fig. 6-23)
- (2) Use the supplied screws to attach the corner cover to the ceiling panel.

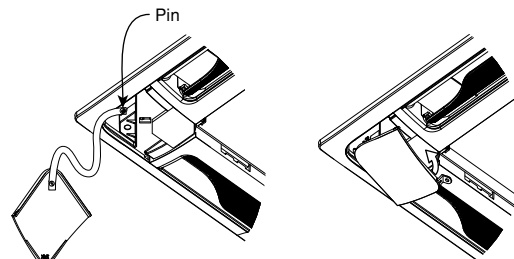

Place the corner cover so that the 3 tabs fit into the holes in the ceiling panel. Then fasten it in place with the supplied screws.

Fig. 6-23

B. Attaching the air-intake grille

- To install the air-intake grille, follow the steps for 3-6-1. **Before Installing the Ceiling Panel** in the reverse order. By rotating the air-intake grille, it is possible to attach the grille onto the ceiling panel from any of 4 directions. (Fig. 6-25)

- **When attaching the air-intake grille, be careful that the flap and the indicator wiring do not become caught.**
- **Be sure to attach the safety cord that prevents the air-intake grille from dropping off to the ceiling panel unit as shown in Fig. 6-24.**

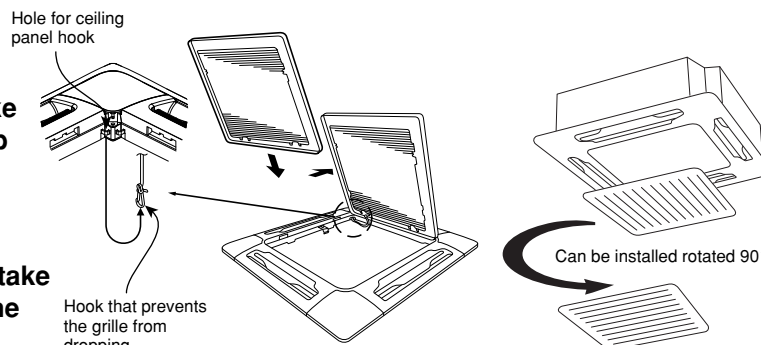

Fig. 6-24

* The grille can be installed with these hinges facing in any of 4 directions.

Fig. 6-25

3-6-5. Checking After Installation

- Check that there are no gaps between the unit and the ceiling panel, or between the ceiling panel and the ceiling surface. Gaps may cause water leakage and condensation.
- Check that the wiring is securely connected.

If it is not securely connected, the auto flap will not operate. In addition, water leakage and condensation may occur.

3-6-6. When Removing the Ceiling Panel for Servicing

When removing the ceiling panel for servicing, remove the air-intake grille and air filter, disconnect the flap and the indicator wiring connectors inside the control box, and then remove the 4 mounting screws.

3-6-7. Adjusting the Auto Flap

The air-direction flap on the ceiling panel outlet can be adjusted as follows.

- Adjust the flap to the desired angle using the remote controller. The flap also has an automatic air-sweeping mechanism.

NOTE

- Never attempt to move the flap by hand.
- Proper air flow depends on the location of the air conditioner, the layout of the room and furniture, etc. If cooling or heating seems inadequate, try changing the direction of the air flow.

3-7. Wiring Instructions

General precautions on wiring

- (1) Before wiring, confirm the rated voltage of the unit as shown on its nameplate, then carry out the wiring closely following the wiring diagram.
- (2) Provide a power outlet to be used exclusively for each unit, with a power supply disconnect and circuit breaker for overcurrent protection provided in the exclusive line.
- (3) To prevent possible hazards due to insulation failure, the unit must be grounded.
- (4) Each wiring connection must be done tightly and in accordance with the wiring system diagram. Wrong wiring may cause the unit to misoperate or become damaged.
- (5) Do not allow wiring to touch the refrigerant tubing, compressor, or any moving parts of the fan.
- (6) Unauthorized changes in the internal wiring can be very dangerous. The manufacturer will accept no responsibility for any damage or misoperation that occurs as a result of such unauthorized changes.

3-8. Wiring Instructions for Inter-unit Connections

- (1) Remove the 1 screw from the terminal cover, then open the cover. Be careful that the cover does not fall.
- (2) Remove the 3 screws from the power box cover, then open the cover. Be careful that the cover does not fall.
- (3) Use the screw to securely fasten the ground wire from the outdoor unit in place.
- (4) Remove the transparent plastic cover from the 3P terminal plate.
- (5) While viewing the wiring diagram, connect the inter-unit and power supply line to terminals 1, 2 and 3 on the 3P terminal plate.
- (6) Remount the transparent plastic cover onto the 3P terminal plate.
- (7) Be sure to use the clamping strap to fasten the wires in place.
- (8) Tighten the screws to remount the terminal and the power box cover.

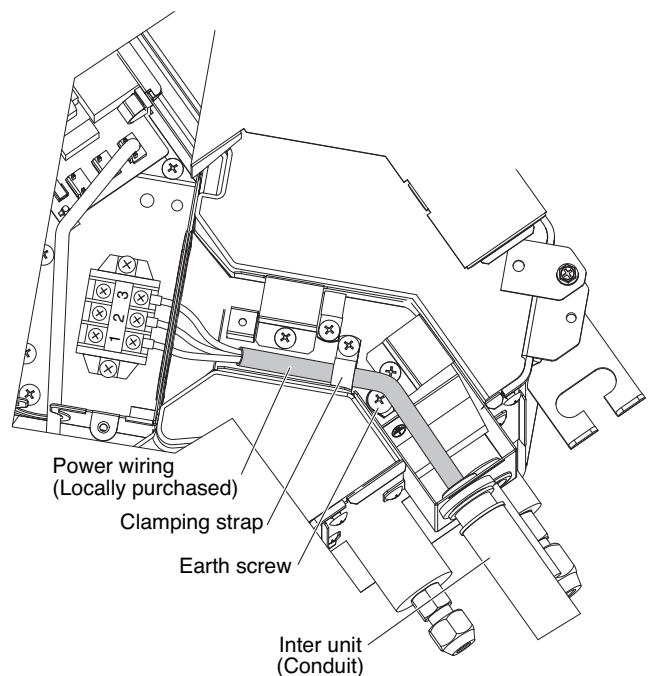

Fig. 8

**WARNING**

Loose wiring may cause the terminal to overheat or result in unit malfunction. A fire hazard may also exist. Therefore, be sure all wiring is tightly connected.

When connecting each power wire to the corresponding terminal, follow the instructions "How to connect wiring to the terminal" and fasten the wire securely tight with the fixing screw of the terminal plate.

How to connect wiring to the terminal**a) For Indoor Unit**

- (1) Cut the wire end with a cutting pliers, then strip the insulation to expose the wire about $9/32"$ (7 mm). See the label (Fig. 28) near the terminal plate.
- (2) Using a screwdriver, loosen the terminal screw on the terminal plate.
- (3) Insert the wire and tighten the terminal screw completely using a screwdriver.

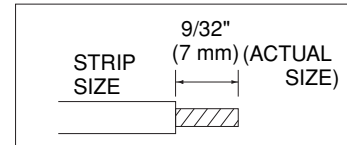
**Fig. 28****b) For Outdoor Unit****■ For solid core wiring (or F-cable)**

- (1) Cut the wire end with a cutting pliers, then strip the insulation to expose the solid wire about $15/16"$ (25 mm). (Fig. 29)
- (2) Using a screwdriver, remove the terminal screw(s) on the terminal plate.
- (3) Using the pliers, bend the solid wire to form a loop suitable for the terminal screw.
- (4) Shape the loop wire properly, place it on the terminal plate and fix it securely with the removed terminal screw using a screwdriver.

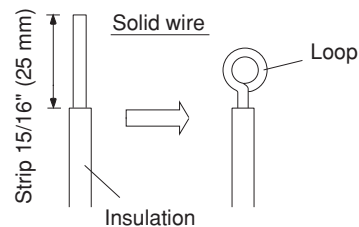
**Fig. 29****■ For stranded wiring**

- (1) Cut the wire end with a cutting pliers, then strip the insulation to expose the stranded wiring about $3/8"$ (10 mm) and tightly twist the wire ends. (Figs. 30 and 31)
- (2) Using a screwdriver, remove the terminal screw(s) on the terminal plate.
- (3) Using a ring connector fastener or pliers, securely clamp each stripped wire end with a ring connector. (Fig. 30)
- (4) Place the ring connector wire, and replace and tighten the removed terminal screw using a screwdriver. (Fig. 32)

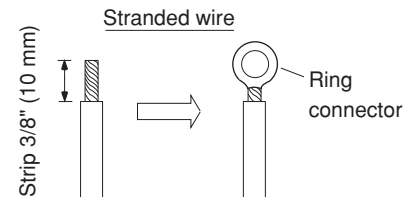
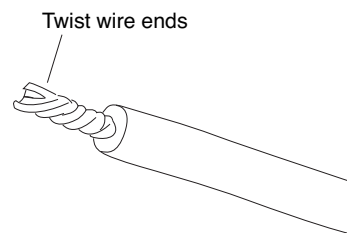
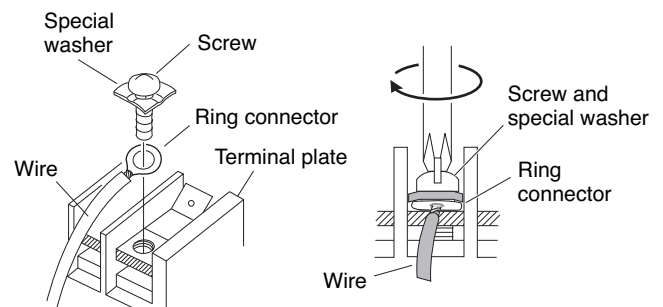
**Fig. 30****Fig. 31****Fig. 32**

4. How to Test Run the Air Conditioner

After turning on the power of the air conditioner, use the remote controller and follow the steps below to conduct the test run.

- (1) Set the remote controller in Test Run mode. (Fig. 33)
 - a) Press and hold the HIGH POWER button and the 1HR. TIMER button.
 - b) Then press and hold the ACL (Reset) button with a pointed object such as the tip of a pen. After 5 seconds, release the ACL button first.
 - c) Then release the HIGH POWER and 1HR. TIMER buttons.
 - d) ✻ appears and "oP-1" blinking in the remote controller clock display area. (Fig. 34)
- (2) Start Cooling mode test run by pressing the ON/OFF operation button of the remote controller. (Fig. 33)
 - This starts the fan producing uncooled forced air with the 3 indicator lamps (OPERATION lamp, TIMER lamp, and HIGH POWER lamp) on the main unit blinking. (Fig. 35)
 - After 3 minutes, the system shifts into cooling operation, and cool air will start to be felt. Cooling mode test run is unaffected by the room temperature.
- (3) Press the ON/OFF operation button of the remote controller again to stop the test run. (Fig. 33)
- (4) Finally press the ACL (Reset) button of the remote controller to release it from Test Run mode to return to normal mode. (Fig. 33)
 - "✻" and "oP-1" will disappear from the remote controller clock display area.

NOTE

Troubleshooting:

In the event that the green OPERATION lamp is blinking upon powering up the system, an error condition exists. In this case, refer to the self-diagnostics procedure which can be seen by opening the air-intake grille.

IMPORTANT

After the test run is completed, be sure to press the ACL (Reset) button to return to normal mode. The air conditioner will not operate correctly if this is not done.

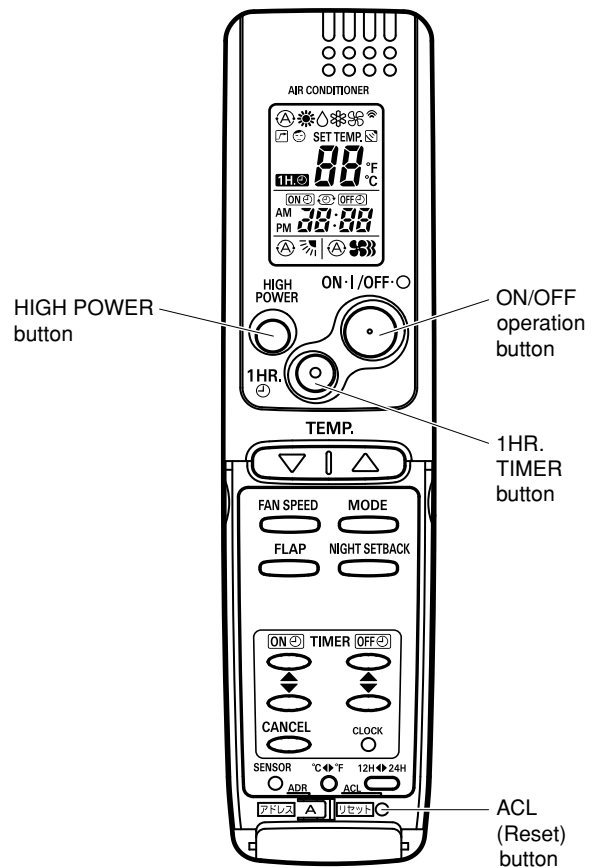

Fig. 33

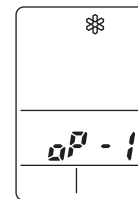

Fig. 34

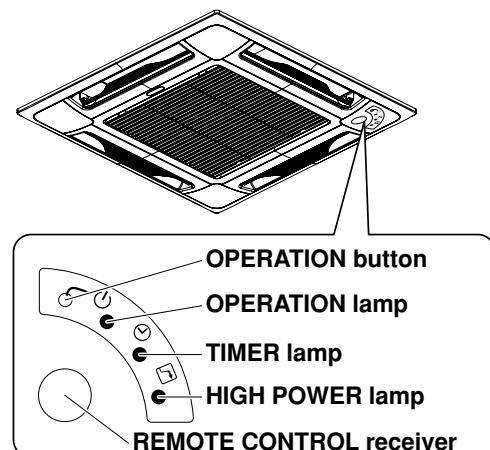

Fig. 35

5. Remote Control Unit Installation Position

The remote control unit can be operated from either a non-fixed position or a wall-mounted position.

To ensure that the air conditioner operates correctly, do not install the remote control unit in the following places:

- In direct sunlight
- Behind a curtain or other place where it is covered
- More than 26' (8 m) away from the air conditioner
- In the path of the air conditioner's airstream
- Where it may become extremely hot or cold
- Where it may be subject to electrical or magnetic interference
- Where there is an obstacle between the remote control unit and the air conditioner (since a check signal is sent from the remote control unit every 5 minutes)

5-1. Mounting on a Wall

Before mounting the remote control unit, press the ON/OFF operation button at the mounting location to make sure that the air conditioner operates from that location. The indoor unit should make a beeping sound to indicate that it has received the signal.

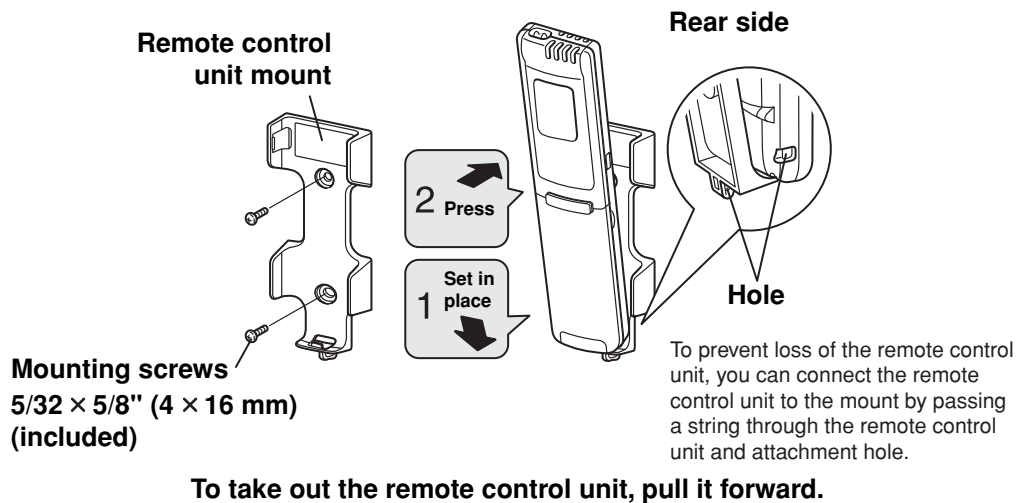

Fig. 36

6. Address Switch

6-1. Address Setting of the Remote Control Unit

The address can be set in order to prevent interference between remote controllers when 2 indoor units are installed near each other. The address is normally set to "A." To set a different address, it is necessary to change the address on the second remote controller.

NOTE

Once changed, you cannot restore the original address setting of the air conditioner.

- (1) Switch on the power source.
- (2) Break the address-setting tab marked "A" on the second remote controller to change the address (Fig. 37). When the tab is removed, the address is automatically set to B (Fig. 38).
- (3) Press and hold the remote controller HIGH POWER button and 1HR. TIMER button. Then, press and hold the ACL (Reset) button with a pointed object such as the tip of a pen. After 5 seconds, release the ACL button first, then release the HIGH POWER and 1HR. TIMER buttons. "oP-1" (Test Run) appears, blinking in the remote controller clock display area.
- (4) Each time the 1HR. TIMER button is pressed, the display changes as shown below. Press this button 2 times to change the display to "oP-7" (Address setting). (Fig. 39)

oP-1	Test run mode
↓	
oP-3	Self-diagnostic mode
↓	
oP-7	Address setting mode

- (5) "oP-7" has now been selected for address setting.
- (6) Press the ON/OFF operation button on the remote controller. (Fig. 39) Check that the "beep" signal-received sound is heard from the second indoor unit (approximately 5 times). The sound you hear is the signal that the remote controller address has been changed.
- (7) Finally press the remote controller ACL (Reset) button to cancel the blinking "oP-7" display. (Fig. 39)

Changing of the second remote controller address is now completed.

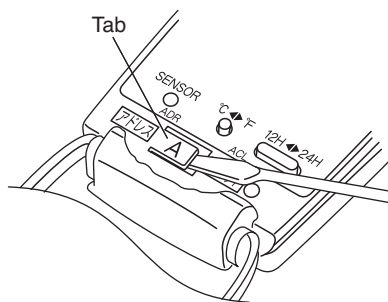

Fig. 37

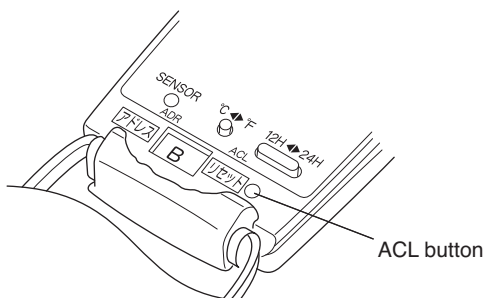

Fig. 38

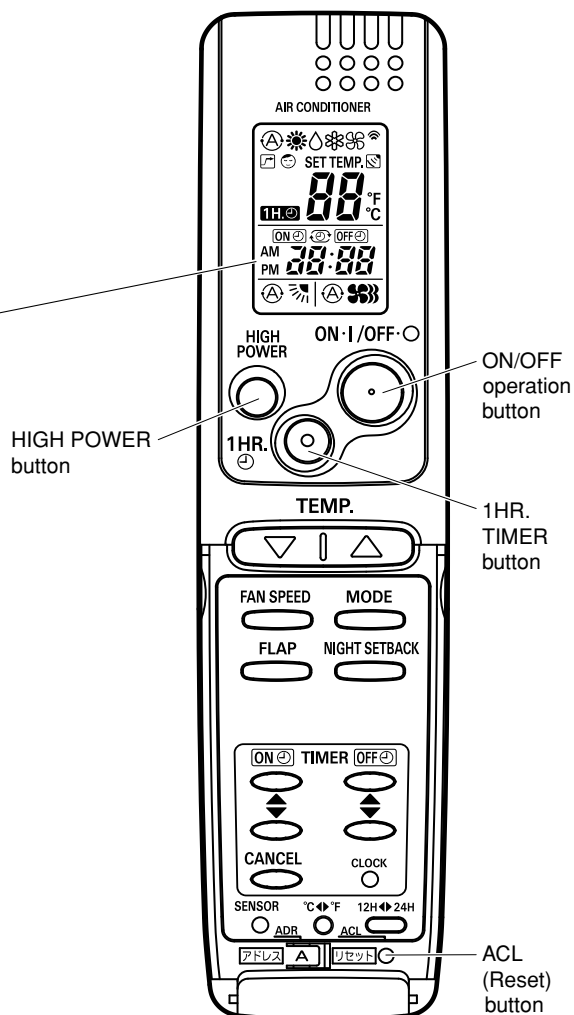

Fig. 39

7. Connecting a Home Automation Device

The HA (white) 4P terminal is located on the indoor unit PCB. If a HA device will be used, connect it to this terminal.

8. Installation Check Sheet

- The strength of the installation location is sufficient to support the air conditioner weight.
- The indoor and outdoor units are installed level and vertically.
- The power and voltage are as specified.
- Inter-unit cables are securely inserted into the terminal block.
- Inter-unit cables are securely fixed.
- The power cable and inter-unit cables are not connected anywhere along their paths.
- The ground wire is securely connected.
- Thermal insulation has been applied to the tubing connections.
- Drain connections are secure and water drains properly.
- Putty has been used to close the hole in the wall.
- Remote controller signals are being positively received.

APPENDIX D INSTRUCTION MANUAL

STK-RCS-7TWSUA

(OI-852-6-4181-139-00-0)

INSTRUCTION MANUAL

Wired Remote Controller

EG**MODE D'EMPLOI**

Télécommande Filaire

F

This wired remote controller is designed for both the "COOL/DRY/HEAT Model" and "COOL/DRY Model" indoor unit.

Before using the remote controller, be sure to confirm the "model type" specified on the front cover of the INSTRUCTION MANUAL supplied with the indoor unit.

Once the wired remote controller is connected, the wireless remote controller cannot be used.

Save These Instructions!
Conserver ce mode d'emploi

CONTENTS

	Page
PRODUCT INFORMATION	2
ALERT SYMBOLS	2
INSTALLATION LOCATION	2
ELECTRICAL REQUIREMENTS	2
SAFETY INSTRUCTIONS	2
FEATURES	3
REMOTE CONTROL UNIT	4
OPERATION WITH THE REMOTE CONTROL UNIT	6
1. Automatic Operation (only for COOL/DRY/HEAT Model)	6
2. Manual Operation	6
3. Adjusting the Fan Speed	7
4. Fan Only	7
5. Night Setback Mode	7
SPECIAL REMARKS	7
SETTING THE TIMER	8
USING THE 1-HOUR OFF TIMER	9
ADJUSTING THE AIRFLOW DIRECTION	9

PRODUCT INFORMATION

If you have problems or questions concerning your wired remote controller, you will need the following information.

Model No. _____

Date of purchase _____

Dealer's address _____

Phone number _____

ALERT SYMBOLS

The following symbols used in this manual, alert you to potentially dangerous conditions to users, service personnel or the appliance:



WARNING

This symbol refers to a hazard or unsafe practice which can result in severe personal injury or death.



CAUTION

This symbol refers to a hazard or unsafe practice which can result in personal injury or product or property damage.

INSTALLATION LOCATION

We recommend that this wired remote controller be installed properly by qualified installation technicians in accordance with the Installation Instructions provided with the unit.



WARNING

- Do not install this wired remote controller where there are fumes or flammable gases, or in an extremely humid space such as a greenhouse.
- Do not install the wired remote controller where excessively high heat-generating objects are placed.

Avoid:

To protect the air conditioner from heavy corrosion, avoid installing the outdoor unit where salty sea water can splash directly onto it or in sulphurous air near a spa.

ELECTRICAL REQUIREMENTS

1. All wiring must conform to the local electrical codes. Consult your dealer or a qualified electrician for details.
2. Each unit must be properly grounded with a ground (or earth) wire or through the supply wiring.
3. Wiring must be done by a qualified electrician.

SAFETY INSTRUCTIONS

- Read this Instruction Manual carefully before using this air conditioner. If you still have any difficulties or problems, consult your dealer for help.
- This air conditioner is designed to give you comfortable room conditions. Use this only for its intended purpose as described in this Instruction Manual.



WARNING

- Never use or store gasoline or other flammable vapor or liquid near the air conditioner — it is very dangerous.
- This air conditioner has no ventilator for intaking fresh air from outdoors. You must open doors or windows frequently when you use gas or oil heating appliances in the same room, which consume a lot of oxygen from the air. Otherwise there is a risk of suffocation in an extreme case.



CAUTION

- Do not turn the air conditioner on and off from the power mains switch. Use the ON/OFF operation button.
- Do not stick anything into the air outlet of the outdoor unit. This is dangerous because the fan is rotating at high speed.
- Do not let children play with the air conditioner.
- Do not cool or heat the room too much if babies or invalids are present.

FEATURES

- Microprocessor Controlled Operation
- 24-Hour ON or OFF Timer
- 1-Hour OFF Timer
- Night Setback
- Automatic and 3-step Fan Speed
- Air Sweep Control

- Automatic Restart Function for Power Failure
- Automatic Switching between Cooling and Heating
(This function is available only for "Single use" of COOL/DRY/HEAT Model.)
- Hot Start Heating System
(This function is available only for COOL/DRY/HEAT Model.)

NOTE

- Since the wired remote controller is designed to be commonly used for various air conditioners, some of the functions of the wireless remote controller supplied with the indoor unit cannot be used.
- "Single use" means that only one indoor unit is connected with one outdoor unit in a one-unit-to-one-unit configuration.
- "Multiple use" (i.e. Flexi-Multi system) means that two or more indoor units are connected with one outdoor unit in a multiple-unit-to-one-unit configuration.

REMOTE CONTROL UNIT (DISPLAY)

Displayed when indoor unit sensor is in use

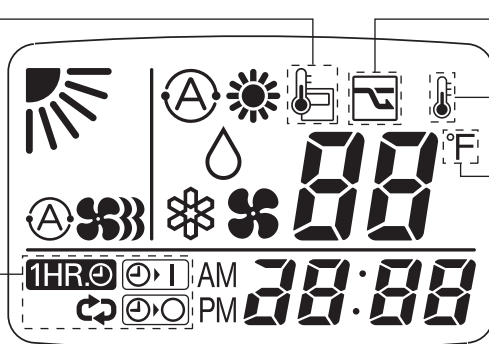

Displayed when operating NIGHT SETBACK mode

Displayed when setting temperature

Displayed when temperature is shown

Displayed when setting timer

Symbols

(1) Operation mode

- AUTO
(only for COOL/DRY/HEAT Model)
- HEAT
(only for COOL/DRY/HEAT Model)



- MILD DRY



- COOL.....



- FAN



(2) Fan speed

- Automatic operation



- HIGH



- MEDIUM.....



- LOW



(3) Temperature setting

- 60 – 86 °F



- When set to 80 °F temperature indication



(4) Timer

- 24-hour clock with ON/OFF program Timer



- ON Timer.



- OFF Timer.



- 1-hour OFF Timer.



(5) NIGHT SETBACK.....



(6) Flap angle indication.....



- Sweep indication.....



REMOTE CONTROL UNIT

NOTE

The descriptions on the AUTO (Ⓐ) or HEAT (☀️) operation mode are only for the “COOL/DRY/HEAT Model,” and not for the “COOL/DRY Model.”

Display

Information on the operating conditions is displayed while the remote control unit is switched on. If the unit is turned off, only the mode that was set previously is still displayed.

Temperature setting buttons (TEMP.)

Press the ▲ button to increase the set temperature.

Press the ▼ button to reduce the set temperature.

The temperature setting changes by 2 °F each time one of the TEMP. buttons is pressed.

FAN SPEED selector button

Ⓐ 🌀 : The air conditioner automatically decides the fan speeds.

🌀🌀 : High fan speed

🌀 : Medium fan speed

🌀 : Low fan speed

NIGHT SETBACK button

For details, see “5. Night Setback Mode”. When you press this button in the HEAT, DRY or COOL mode, the 🌙 mark appears in the display, and the remote control unit will automatically adjust the set temperature to save energy.

FLAP button

Press this button either to select the setting of the airflow direction to one of the six possible positions manually or to select the sweep function which moves the flap up and down automatically.

↙ : The airflow direction can be set manually. (six positions)

🌀 : The flap moves up and down automatically.

NOTE

When you press the FLAP button, the air flow direction will be changed one by one as follows.

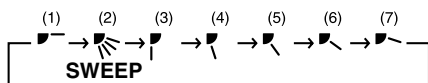

Timer and Present Time setting buttons

First, press the SET button to select the mode (ON, OFF and Present Time settings) you want.

Each time you press the “HH” button, the hours advance by one.

(PM0, PM1.....PM11, AM0, AM1.....AM11)

Each time you press the “MM” button, the minutes advance by one when setting Present Time and by ten when setting ON and OFF Time.

SET button

For details, see “Setting the Timer”.

Press this button to select the mode you want to program.

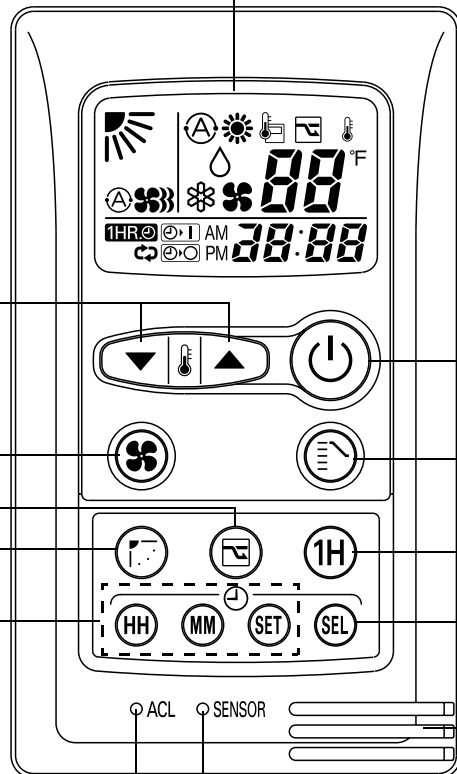

ACL button (ALL CLEAR)





When you press the ACL button while the operation button is ON, all settings are cleared. Press the ACL button if the air conditioner is not operating correctly.

ON/OFF operation button

This button is for turning the air conditioner on and off.

MODE selector button

Use this button to select AUTO, HEAT, DRY, COOL or FAN mode.



- (AUTO)**  : When this setting is selected, the air conditioner calculates the difference between the thermostat setting and the room temperature and automatically switches to the "COOL" or "HEAT" mode as appropriate. (This function is available only for "Single use" of COOL/DRY/HEAT Model.)
- (HEAT)**  : The air conditioner makes the room warmer.
- (DRY)**  : The air conditioner reduces the humidity in the room.
- (COOL)**  : The air conditioner makes the room cooler.
- (FAN)**  : The air conditioner works only as a circulation fan except for "Multiple use" of COOL/DRY/HEAT Model.

1 HR. TIMER button (1-HOUR OFF TIMER)

1HR  : When you press this button, regardless of whether the unit is operating or stopping, the unit operates for one hour and then shuts down.

TIMER SELECT button

No display : The timer does not operate.

-  : The air conditioner starts at the set time.
-  : The air conditioner stops at the set time.
-  : The air conditioner stops and starts, or starts and stops, at the set times every day.

Sensor

A temperature sensor inside the remote control unit senses the room temperature.

SENSOR button

When you press this button (use a small-tipped object such as a ballpoint pen), the  mark will disappear at the display. And the room temperature is detected by the sensor which is built into the remote control unit and the air conditioner is controlled accordingly.

NOTE

If the remote control unit is located near a heat source, such as a space heater or in direct sunlight, press the SENSOR button to switch to the sensor on the indoor unit.

NOTE

The indoor fan runs continuously when the system is in normal operation. It does not turn off when the desired room temperature is reached. If Night Set Back mode is selected, the fan will turn off intermittently during cooling operation in order to control air flow.

OPERATION WITH THE REMOTE CONTROL UNIT

1. Automatic Operation (only for COOL/DRY/HEAT Model)

- Single use
This unit automatically switches between cooling operation and heating operation according to the difference between the room temperature and the temperature setting.
- Multiple use
The air conditioner calculates the difference between the thermostat setting and room temperature, and automatically determines the mode to operate under cooling or heating. Then, the air conditioner continuously operates under the mode selected at initial operation.

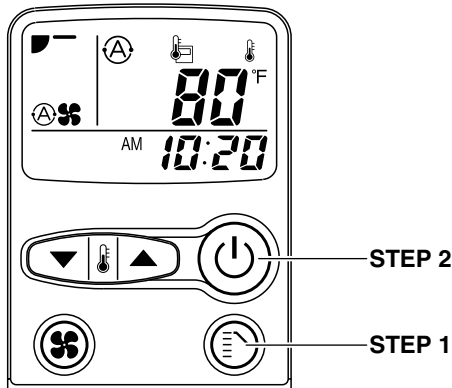

NOTE Check that the circuit breaker on the power panel is turned on.

Once mode is selected and the unit is preset by following the steps below, you can have the air conditioner automatically bring the room to the desired temperature simply by pressing the ON/OFF operation button.

STEP 1	Press the MODE selector button to .
STEP 2	Press the ON/OFF operation button.

To stop the air conditioner, press the ON/OFF operation button again.

NOTE To change the temperature setting; press the temperature setting buttons and change the setting to the desired temperature.

2. Manual Operation

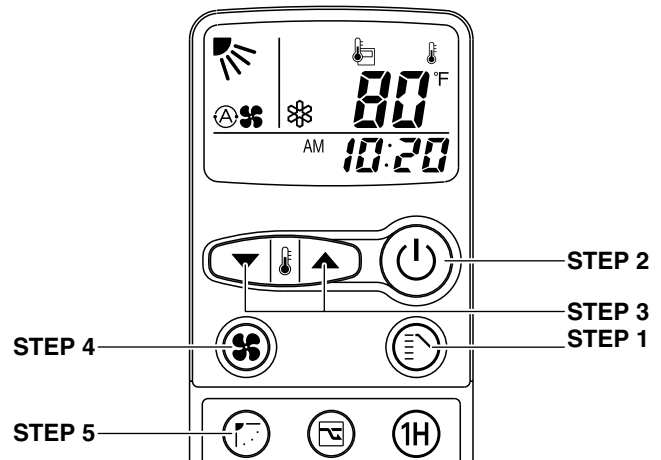

NOTE Check that the circuit breaker on the power panel is turned on.

If the automatic operation settings of the unit do not meet your needs, press the setting buttons as described below and change the settings as desired.

STEP 1	Press the MODE selector button and select the desired mode. For heating operation → For dehumidifying operation → For cooling operation → For fan only operation (No Fan mode in "Multiple use" of COOL/DRY/HEAT Model) →
STEP 2	To start the air conditioner, press the ON/OFF operation button.
STEP 3	Press the TEMP. setting buttons to change the temperature setting to the desired temperature. Adjustable temperature range: 86 °F max. 60 °F min.
STEP 4	Set the FAN SPEED selector button to the setting you want.
STEP 5	Press the FLAP button and set the airflow direction as desired. (Refer to "ADJUSTING THE AIRFLOW DIRECTION" on page 9.)

To stop the air conditioner, press the ON/OFF operation button again.

- NOTE**
- Choose the best position in the room for the remote control unit, which also acts as the sensor for room comfort and transmits the operating instructions. Once you've found this best position, always keep the remote control unit there.
 - This appliance has a built-in 5-minute time delay circuit to ensure reliable operation. When the operation button is pressed, the compressor will start running within three minutes. In the event of power failure, the unit will stop.
 - The display on the remote control unit shows the setting temperature and not the room temperature.
 - When multiple indoor units are used and units in other rooms are already operating, they will be operating with the same mode as the operating indoor units. (only for "Multiple use" of COOL/DRY/HEAT Model)

3. Adjusting the Fan Speed

A. Automatic fan speed

Simply set the FAN SPEED selector button to the position.

This automatically sets the best fan speed for the room temperature.

B. Manual fan speed

If you want to adjust fan speed manually during operation, just set the FAN SPEED selector button as desired. [, , or]

4. Fan Only

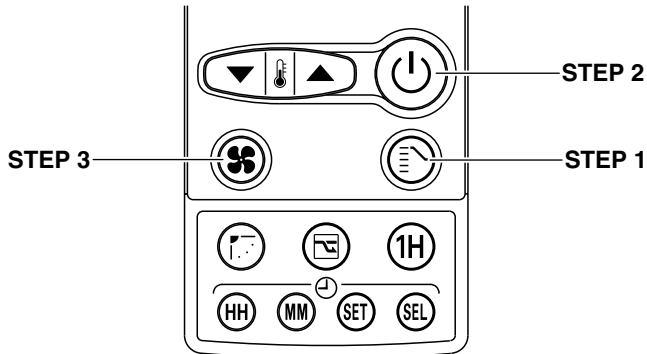

If you want to circulate air without any temperature control, follow these steps:

STEP 1	Press the MODE selector button to switch to the fan mode .
STEP 2	Press the ON/OFF operation button.
STEP 3	Press the FAN SPEED selector button to select the fan speed of your choice (, , or).

NOTE There is no FAN only function in "Multiple use" of COOL/DRY/HEAT Model.

5. Night Setback Mode

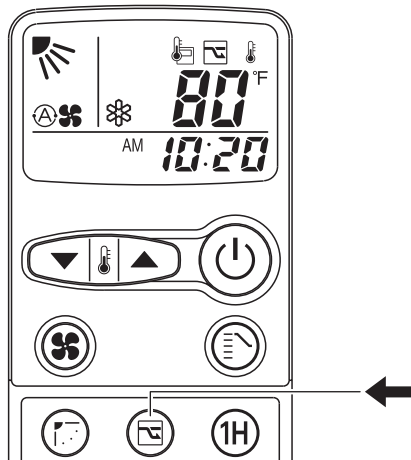

Night Setback Mode is used for saving energy.

Press the NIGHT SETBACK button while operation. The mark appears in the display.

To release the night setback function, press the NIGHT SETBACK button again.

A. In Cooling and DRY Mode: (and)

When the night setback mode is selected, the air conditioner automatically raises the temperature setting 2 °F when 30 minutes have passed after the selection was made, and then another 2 °F after another 30 minutes have passed, regardless of the indoor temperature when night setback was selected. This enables you to save energy without sacrificing comfort. This function is convenient when gentle cooling is needed.

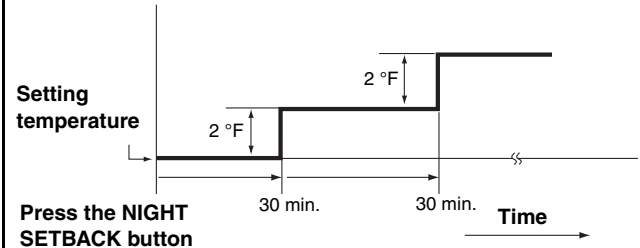

B. In Heating Mode: () (only for COOL/DRY/HEAT Model)

When the night setback mode is selected, the air conditioner automatically lowers the temperature setting 4 °F when 30 minutes have passed after the selection was made, and then another 4 °F after another 30 minutes have passed, regardless of the indoor temperature when night setback was selected. This enables you to save energy without sacrificing comfort. This function is convenient when gentle heating is needed.

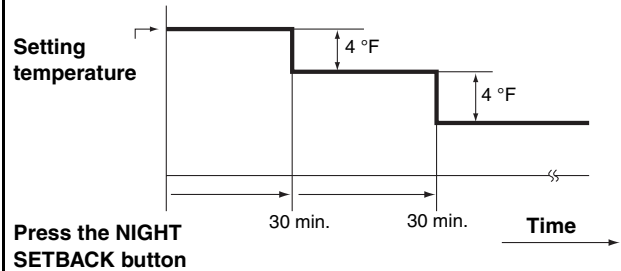

SPECIAL REMARKS

Power failure during operation

In the event of power failure, the unit will stop. When the power is resumed within 8 hours, the unit will restart automatically in approximately five minutes, or 15 minutes in "Multiple use" of COOL/DRY/HEAT Model on AUTO mode by the remote control unit.

Remote Control Unit

The remote control unit sends the setting condition to the air conditioner regularly at five minute intervals.

Remote Control Unit Display

If the display malfunctions, press the ACL button. This resets the remote control unit back to the initial settings. Make the settings again.

SETTING THE TIMER

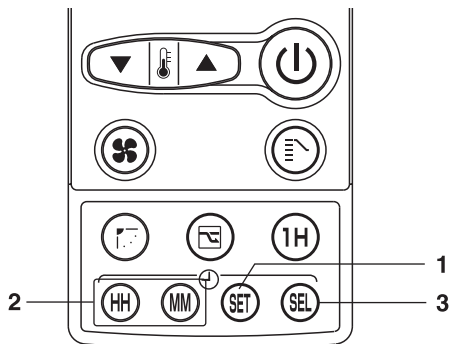

1. How to set the present time

(Example) To set to 9:10 pm.

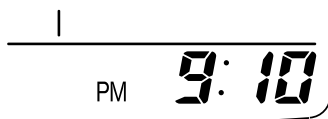

Operation	Indication
1. Press the SET button three times.	The time indication alone flashes.
2. • Press the HH button until PM 9 is displayed. • Press the MM button until 10 is displayed.	The display will flash for 10 sec. and automatically stop flashing except for the “:” symbol.

2. How to set the OFF time

(Example) To stop the air conditioner at 11:30 pm.

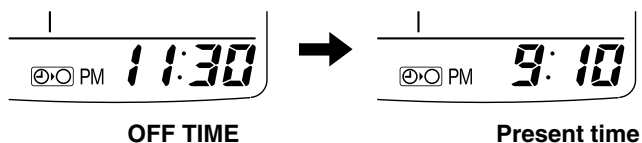

Operation	Indication
1. Press the SET button twice.	The timer indication alone flashes and the previous set-time is only displayed.
2. • Press the HH button until PM 11 is displayed. • Press the MM button until 30 is displayed.	The display will change automatically back to show the present time after about 10 sec.
3. Press the TIMER SELECT button twice to set OFF time.	The present time and are displayed.

To cancel the setting, press the TIMER SELECT button twice.

3. How to set the ON time

(Example) To start operation at 7:10 am.

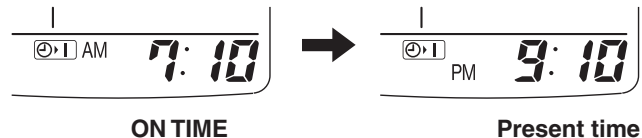

Operation	Indication
1. Press the SET button once.	The timer indication alone flashes and the previous set-time is only displayed.
2. • Press the HH button until AM 7 is displayed. • Press the MM button until 10 is displayed.	The display will change automatically back to show the present time after about 10 sec.
3. Press the TIMER SELECT button once to set ON time.	The present time and are displayed.

To cancel the setting, press the TIMER SELECT button three times.

4. How to set daily ON/OFF repeat timer

(Example) To start operation at 7:10 am. and stop the air conditioner at 11:30 pm.

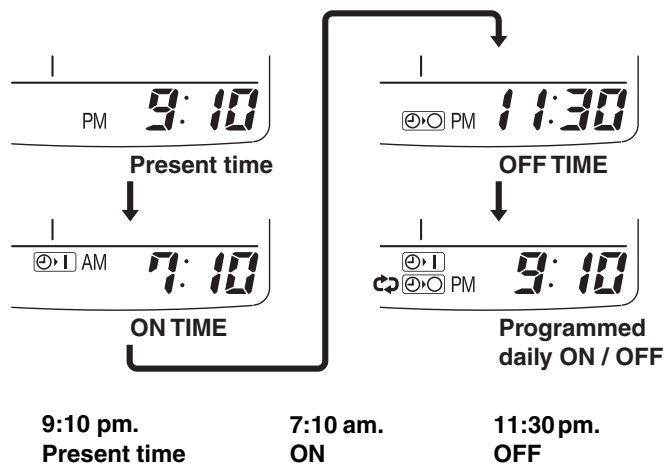

Operation	Indication
Set the timer ON/OFF times as shown in 2 and 3.	The present time PM 9:10 and are displayed.

To cancel the setting, press the TIMER SELECT button once.

NOTE

You can check the timer ON/OFF times after you have set them by pressing the SET button.

5. Backup function

Even if the main power supply to the unit is turned off, the remote controller will store the previous settings in its internal memory for up to 8 hours. If the power is not turned back on within 8 hours, the previous settings will be lost. In this case, the mode settings must be reset by the user.

USING THE 1-HOUR OFF TIMER

1. 1-Hour OFF Timer

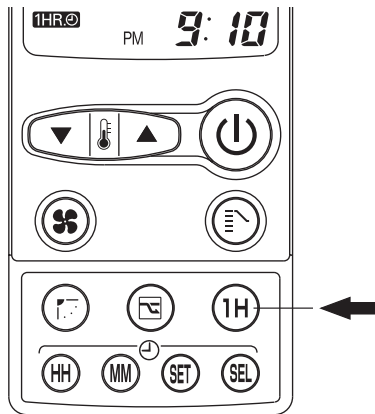

This function causes the unit to operate for one hour and then stop, regardless of whether the unit is on or off when this button is pressed.

The **1HR** indicator in the display indicates that this function is operating.

Setting procedure:

Regardless of whether the unit is operating or stopped, press the 1 HR. TIMER button.

1HR appears in the display.

Cancellation procedure:

Press the ON/OFF operation button to turn the unit off, wait for the unit to stop operating, and then press the ON/OFF operation button again.

The 1-Hour Timer function is now cancelled and the unit operates normally.

NOTE

- If, while the 1-Hour Timer function is operating, the 1HR. TIMER button is pressed once to cancel the function and then again, the unit continues to operate for one hour from that point in time and then stops.
- It is not possible to use the OFF Timer and 1-Hour OFF Timer together. Whichever function is set last takes precedence. If the 1 HR. TIMER button is pressed while the TIMER OFF function operates, the OFF Timer is cancelled and the unit will stop operating one hour later.

2. Operation together with the daily ON/OFF repeat timer

The 1-Hour OFF Timer setting is given priority over the DAILY ON/OFF REPEAT setting.

ADJUSTING THE AIRFLOW DIRECTION

The vertical airflow can be adjusted by moving the flap with the remote control unit. Do not move the flap with your hands. Confirm that the remote control unit has been turned on. Use the FLAP button to set either the sweep function or one of the six airflow direction settings.

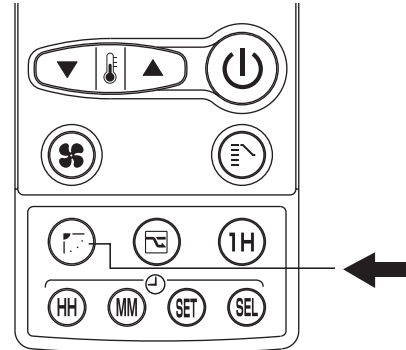

A. Sweep function

The flap starts moving up and down to deliver air over the sweep range.

B. Setting the airflow manually

Referring to the above illustration, use the FLAP button to set the airflow direction within the range used during the heating, cooling, or dehumidifying operation.

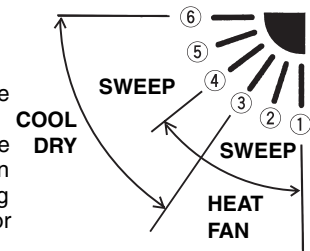

NOTE

- The flap automatically closes when the unit is off.
- During the heating operation, the fan speed will be very low and the flap will be in the horizontal position (position ⑥) until the air being blown out of the unit begins to warm. Once the air warms up, the flap position and fan speed change to the settings specified with the remote control unit.

CAUTION

- Use the FLAP button on the remote control unit to adjust the position of the flap. If you move the flap by hand, the flap position according to the remote control unit and the actual flap position may no longer match. If this should happen, shut off the unit, wait for the flap to close, and then turn on the unit again; the flap position will now be normal again.
- Do not have the flap pointed down during cooling operation. Condensation may begin to form around the air vent and drip down.

APPENDIX E INSTALLATION INSTRUCTIONS

STK-RCS-7TWSUA

(OI-852-6-4190-481-00-1)

IMPORTANT

- In order to install this wired remote controller onto a wall-mounted model, the connection kit (STK-KCW1), which must be purchased separately, is required.
- Once the wired remote controller is connected, the wireless remote controller cannot be used.

Parts supplied with the remote controller

See Table 1.

Remote controller installation guidelines

Installation location

- Mount the remote controller 3.3 to 4.9 ft. (1 to 1.5 meters) off the floor where it can sense the average temperature of the room.
- Do not mount the remote controller in a place exposed to direct sunlight or where it is exposed to outside air such as near a window.
- Do not mount the remote controller behind a curtain or other object so that it is separated from the air circulation of the room.
- Mount the remote controller inside the room being air conditioned.

Switching the room temperature sensor

Room temperature sensors are separately incorporated in both the indoor unit and the remote controller. Either sensor can be used to sense the room temperature. The indoor unit sensor is usually used.







If you wish the remote controller to sense the room temperature, press the SENSOR button with a ballpoint pen or tool with a small tip. (Refer to Fig. 9 on page 4 to locate the SENSOR button.)

How to install the remote controller

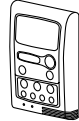
IMPORTANT

- The remote controller is set to "Cool/Dry/Heat model" at the time of shipment from the factory. If the purchased air conditioner is a COOL/DRY model, follow the instructions on the label and change the switch on the reverse side of the remote controller unit to "Cool/Dry model". (Fig. 1)
- The remote controller is also set to "Single" at the time of shipment from the factory. For multiple use, set the switch on the reverse side of the remote controller unit to "Multi". (Fig. 1)
- After all work is completed, if any switches have been changed, then be sure to press the ACL (Reset) button. (Refer to Fig. 9 on page 4 to locate the ACL (Reset) button.)

Table 1

Parts	Figure	Q'ty	Parts	Figure	Q'ty
Wired remote controller		1	Wire harness		1
Machine screws		2	Instruction manual		1
Tapping screws		2	Installation Instructions		1
Spacers		2			

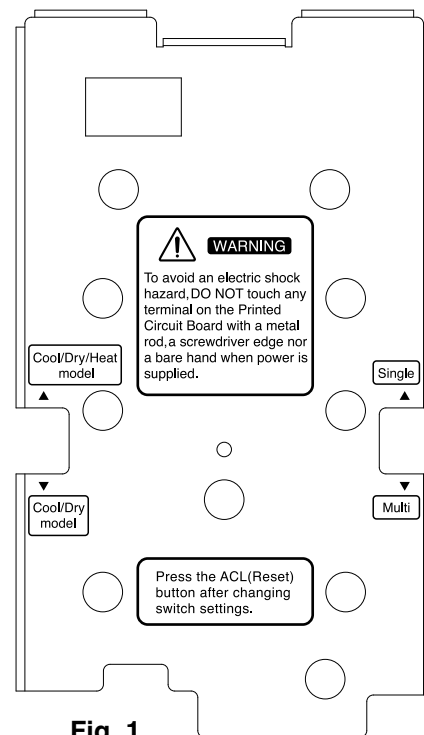

Fig. 1

SANYO Commercial Solutions
 A Division of SANYO North America Corporation
 1300 Michael Drive, Suite A
 Wood Dale, IL 60191, U.S.A.

In Canada
SANYO Canada Inc.
 1-300 Applewood Crescent, Concord
 Ontario, L4K 5C7, Canada

A. Installing with in-wall junction box

- (1) Install the junction box (locally purchased) into the wall. (Figs. 2-a and 3)
- (2) Pass the wire harness through the junction box and conduit. (Fig. 3)
- (3) Insert a flathead screwdriver into the 5 tab locations and disconnect the back plate of the remote controller by lifting up slightly. (Fig. 2-b)
The tabs are thin; take care not to chip them.
- (4) Pass the wire harness connector through the cord opening on the back plate of the remote controller.
- (5) Insert the connector into the PCB of the remote controller unit, and wrap the wire harness around the hook. (Fig. 4)
- (6) Store the excess wire harness inside the junction box, then hook the remote controller unit onto the top of the back plate and install the remote controller unit.
- (7) To remove the remote controller unit after it has been installed, insert a flathead screwdriver into the slot on the bottom of the case and turn it. (Fig. 5)

In-wall junction box (locally purchased)

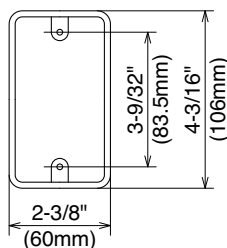

Fig. 2-a

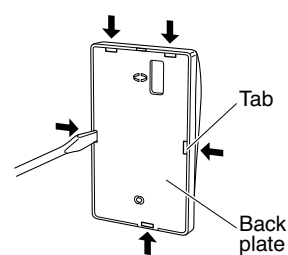

Fig. 2-b

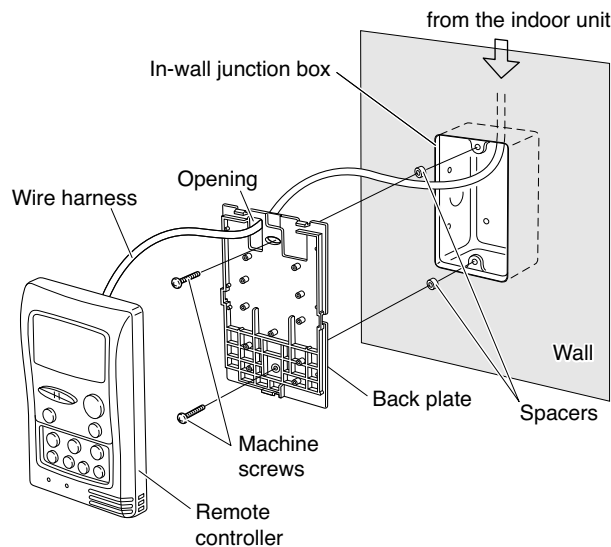

Fig. 3

B. Installing directly onto the wall

- (1) Insert a flathead screwdriver into the 5 tab locations and disconnect the back plate of the remote controller by lifting up slightly. (Fig. 2-b)
The tabs are thin; take care not to chip them.
- (2) Use tapping screws to directly fasten the remote controller back plate onto the wall. (Fig. 6)
- (3) Insert the connector into the PCB of the remote controller unit, and wrap the wire harness around the hook. (Fig. 4)
- (4) Use nippers or a similar tool to cut out the slot on the top of the remote controller unit. Pass the wire harness through the slot, then hook the remote controller unit onto the top of the back plate and install the remote controller unit.
- (5) In order to conceal the exposed wiring, use a wire cover (locally purchased) or similar means.

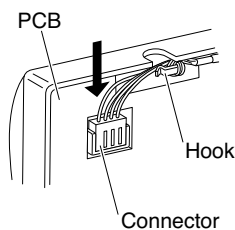

Fig. 4

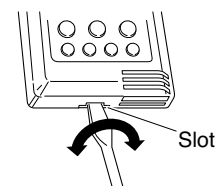

Fig. 5

NOTE

- When installing the remote controller back plate, be sure that it is flat and straight. Do not over-tighten the installation screws.
- Install the remote controller away from all sources of electrical noise.
- Install a noise filter or take other appropriate action if electrical noise affects the power supply circuit of the unit.

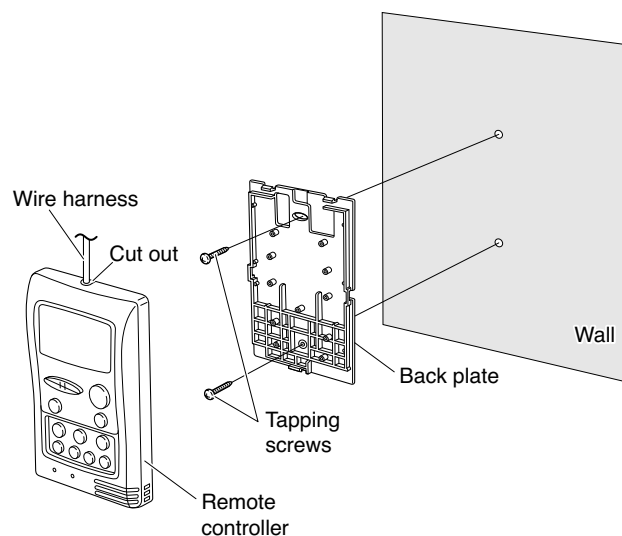

Fig. 6

■ How to wire the remote controller

- (1) Turn OFF the power and remove the ceiling panel air-intake grille. (Refer to **3-6-1 Before Installing the Ceiling Panel** in the Installation Instructions supplied with the indoor unit.)
- (2) Remove the 3 power box cover screws and 2 control box cover screws, then remove both covers. At this time, take care not to drop the covers. (Fig. 7)
- (3) Disconnect the 7P (IND) terminal and 4P (RC) terminal of the 7P IND and 4P RC wiring connectors and the 5P terminal of the 5P FLAP wiring connector from the control box PCB connectors (IND, RC, FLAP). Disconnect each wiring connector from the clamp that fastens it. (Fig. 7)
- (4) Remove the ceiling panel. (To remove the ceiling panel, follow the steps for **3-6 How to Install the Ceiling Panel** in the reverse order. Refer to the Installation Instructions supplied with the indoor unit.)

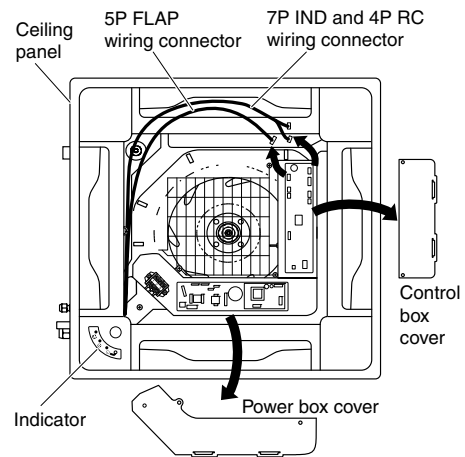

Fig. 7

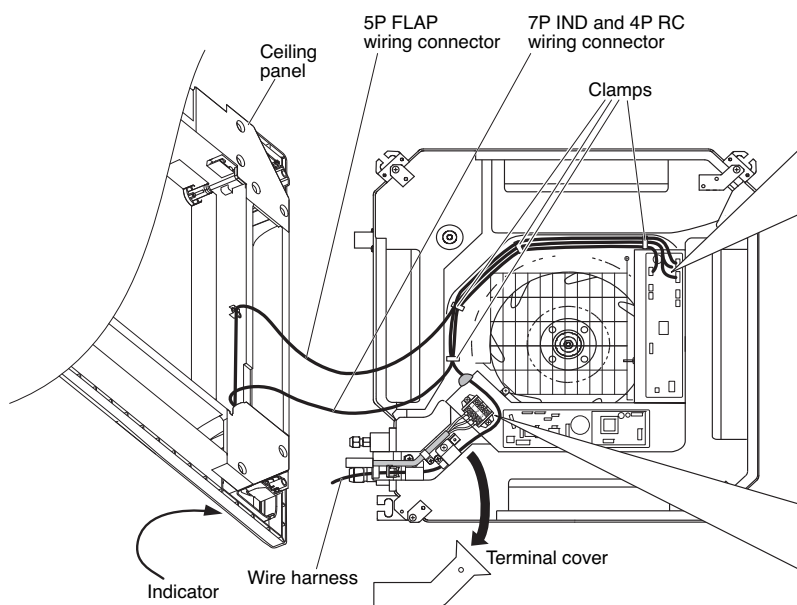

Fig. 8

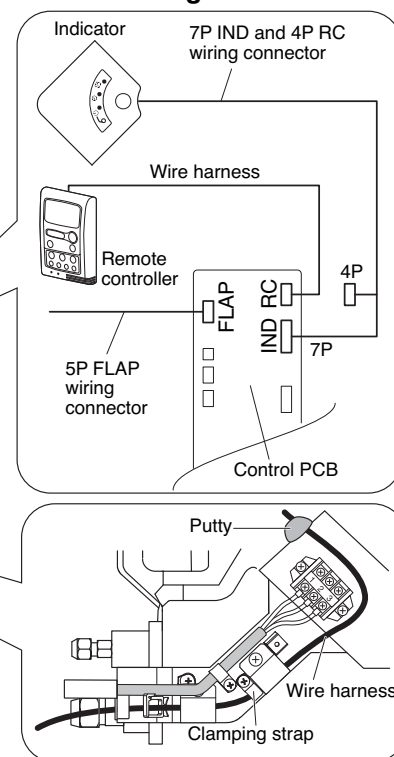

Fig. 8-a

Fig. 8-b

- (5) Remove the terminal cover screws, then remove the cover. At this time, take care not to drop the cover. (Fig. 8)
- (6) Pull in the wire harness from the remote controller as shown in Fig. 8-b.
 - Remove the putty before wiring. After wiring, make sure to restore the putty.
- (7) Insert the wire harness 4P terminal into the control box PCB connector (RC). (Fig. 8-a)
- (8) Install the terminal cover. Then install the ceiling panel. (Refer to **3-6 How to Install the Ceiling Panel** in the Installation Instructions supplied with the indoor unit.)
- (9) Insert only the 7P (IND) terminal of the 7P IND and 4P RC wiring connector into the connector (IND) on the control box PCB. Store the 4P terminal inside the control box. (Fig. 8-a)
- (10) Next, insert the 5P terminal of the 5P FLAP wiring connector into the connector (FLAP) on the control box PCB. (Fig. 8-a)
- (11) When the connections are completed, fasten the wire harness and each wiring connector with the clamps.
- (12) Install the power box cover and control box cover.
- (13) Install the air-intake grille. (Refer to **3-6 How to Install the Ceiling Panel** in the Installation Instructions supplied with the indoor unit.)

■ How to Test Run the Air Conditioner

After turning on the power of the air conditioner, use the remote controller and follow the steps below to conduct the test run.

- (1) Set the remote controller in Test Run mode. (Fig. 9)
 - a) Press and hold the NIGHT SETBACK button and the 1HR. TIMER button.
 - b) Then press and hold the ACL (Reset) button with a pointed object such as the tip of a pen. After 5 seconds, release the ACL button first.
 - c) Then release the NIGHT SETBACK and 1HR. TIMER buttons.
 - d) ❄ appears and "oP-1" blinking in the remote controller clock display area. (Fig. 10)
- (2) Start Cooling mode test run by pressing the ON/OFF operation button of the remote controller. (Fig. 9)
 - This starts the fan producing uncooled forced air with the 3 indicator lamps (OPERATION lamp, TIMER lamp, and HIGH POWER lamp) on the main unit blinking. (Fig. 11)
 - After 3 minutes, the system shifts into cooling operation, and cool air will start to be felt. Cooling mode test run is unaffected by the room temperature.
- (3) Press the ON/OFF operation button of the remote controller again to stop the test run. (Fig. 9)
- (4) Finally press the ACL (Reset) button of the remote controller to release it from Test Run mode to return to normal mode. (Fig. 9)
 - "❄" and "oP-1" will disappear from the remote controller clock display area.

NOTE

Troubleshooting:

In the event that the green OPERATION lamp is blinking upon powering up the system, an error condition exists. In this case, refer to the self-diagnostics procedure which can be seen by opening the air-intake grille.

IMPORTANT

After the test run is completed, be sure to press the ACL (Reset) button to return to normal mode. The air conditioner will not operate correctly if this is not done.

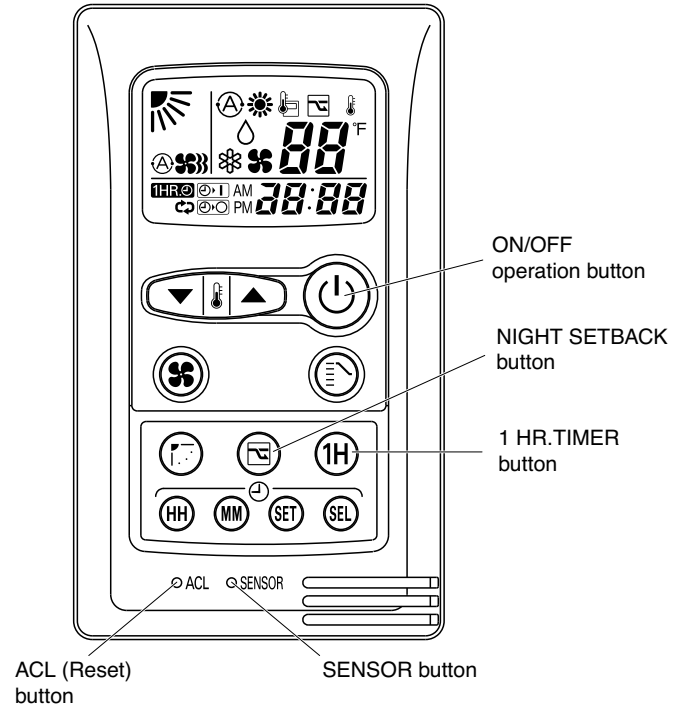

Fig. 9

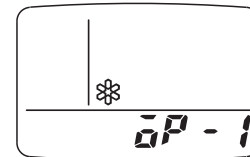

Fig. 10

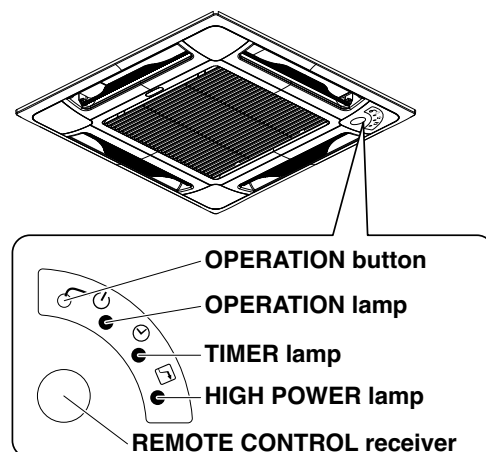

Fig. 11

For Parts or Service Assistance please contact your local Sanyo HVAC Contractor or Distributor

United States: SCS, HVAC Solutions
Web: www.SanyoHVAC.com
Parts: hvac.parts@sna.sanyo.com
Service: hvac.service@sna.sanyo.com

Canada: Sanyo Canada Inc.
Web: www.SanyoHVAC.com
Parts/Service: hvac@sci.sanyo.com

8/09 Printed in Japan

Free Manuals Download Website

<http://myh66.com>

<http://usermanuals.us>

<http://www.somanuals.com>

<http://www.4manuals.cc>

<http://www.manual-lib.com>

<http://www.404manual.com>

<http://www.luxmanual.com>

<http://aubethermostatmanual.com>

Golf course search by state

<http://golfingnear.com>

Email search by domain

<http://emailbydomain.com>

Auto manuals search

<http://auto.somanuals.com>

TV manuals search

<http://tv.somanuals.com>