

## Specifications

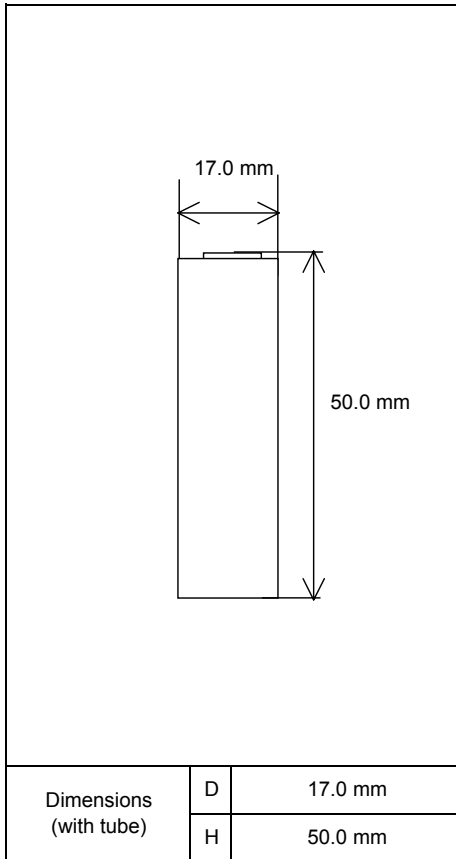

Type : Nickel-Metal Hydride Battery		Size : A	
Capacity <sup>1)</sup>	Typical	2700mAh	
	Minimum	2450mAh	
Nominal Voltage		1.2V	
Charging Current x Time	Fast Charge <sup>2)</sup>	2700 mA x about 1.1h	
Ambient Temp.	Charge Condition	Fast Charge <sup>2)</sup>	
	Discharge Condition	0°C - 50°C	
	Storage Condition	Less than 30days	-20°C - 50°C
		Less than 90days	-20°C - 40°C
Less than 1year		-20°C - 30°C	
Internal Impedance <sup>3)</sup> (after discharge to E.V.=1.0V)		About 20mΩ(at 1000Hz)	
Weight <sup>4)</sup>		About 40 g	
Size <sup>4)</sup> : (Diameter) x (Height)		17.0(D) x 50.0(H) mm	

- 1)Single cell capacity under the following condition.  
Charge : 270mA×16h, Discharge : 540mA(E.V.=1.0V) at 20°C
- 2)Use recommended charging system.
- 3)After a few charge and discharge cycles under the above 1) condition.
- 4)With tube.

## Typical Characteristics

### Charge

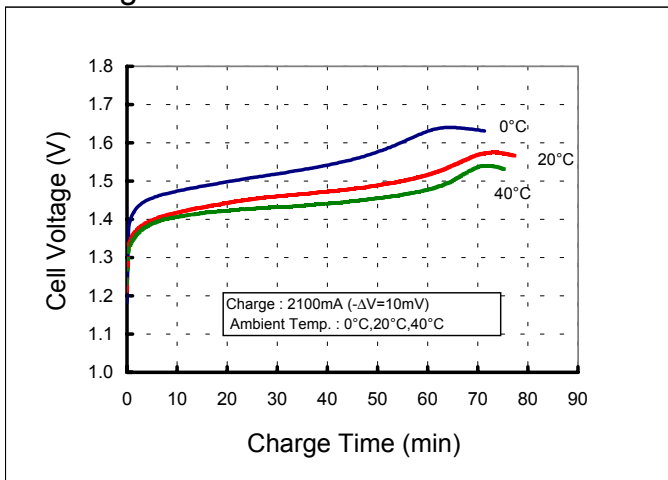

### Discharge

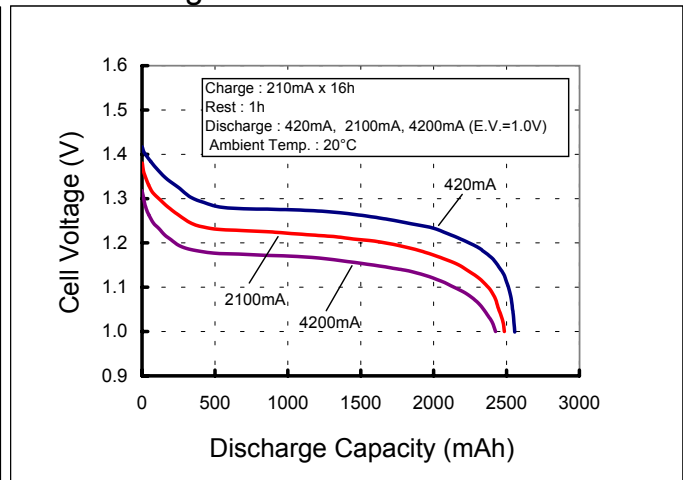

## Free Manuals Download Website

<http://myh66.com>

<http://usermanuals.us>

<http://www.somanuals.com>

<http://www.4manuals.cc>

<http://www.manual-lib.com>

<http://www.404manual.com>

<http://www.luxmanual.com>

<http://aubethermostatmanual.com>

Golf course search by state

<http://golfingnear.com>

Email search by domain

<http://emailbydomain.com>

Auto manuals search

<http://auto.somanuals.com>

TV manuals search

<http://tv.somanuals.com>