

SANYO Cadnica

Cell Type KR-1000SCL Specifications

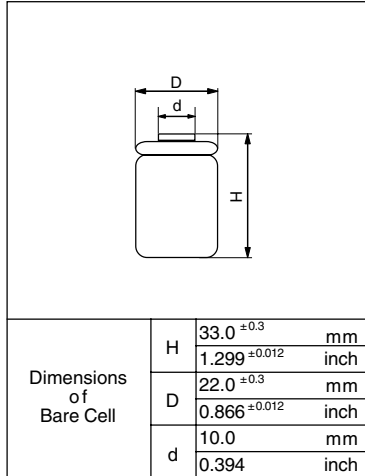

Nominal Capacity		1000mAh		
Nominal Voltage		1.2V		
Charging Current	Standard	100mA		
	Quick	200mA		
Charging Time	Standard	14 to 16Hrs.		
	Quick	7 to 8Hrs.		
Ambient Temperature	Charge	Standard	0°C to +45°C [+32°F to 113°F]	
		Quick	0°C to +45°C [+32°F to 113°F]	
	Discharge		-20°C to +60°C [-4°F to 140°F]	
	Storage		-30°C to +50°C [-22°F to 122°F]	
Internal Impedance (Av.) (at 50% discharge)		7.7mΩ (at 1000Hz)		
Weight		36g/ 1.27oz		
Dimensions(D)×(H) (with tube)		22.9 ⁰ ₋₁	× 34.0 ⁰ _{-1.2}	mm
		0.91 ⁰ _{-0.04}	× 1.34 ⁰ _{-0.04}	inch

Typical Characteristics

Charge

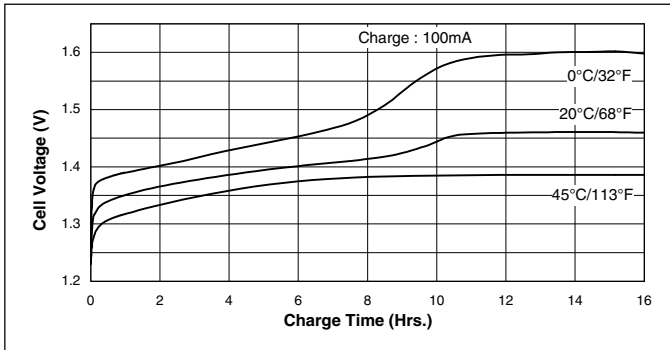

Discharge(at high rate)

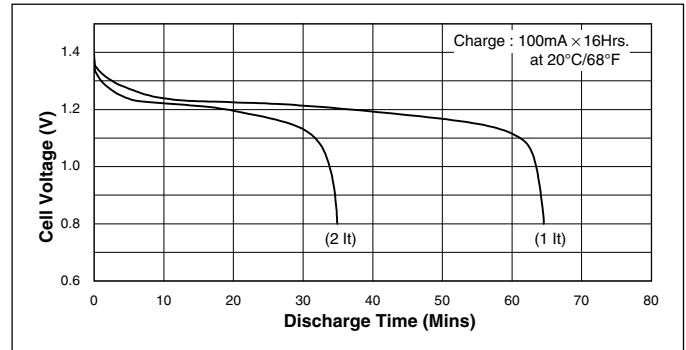

Charge

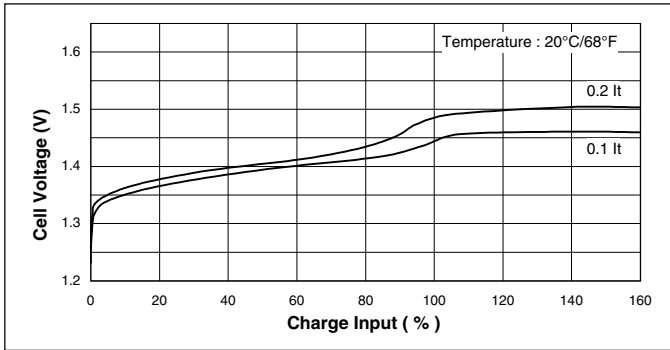

Discharge(at high rate)

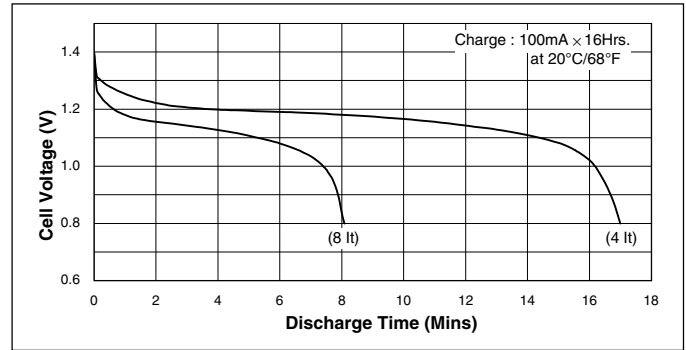

Discharge(at low rate)

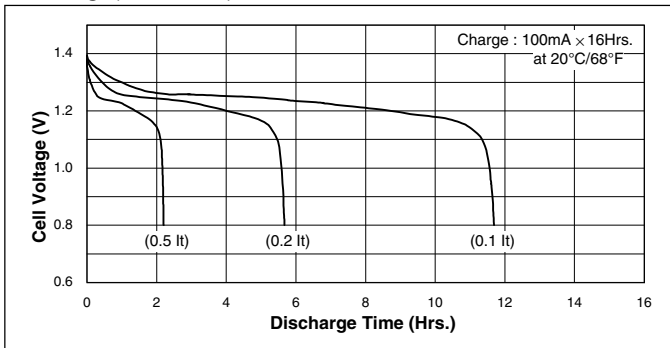

Temperature(Charge & Discharge)

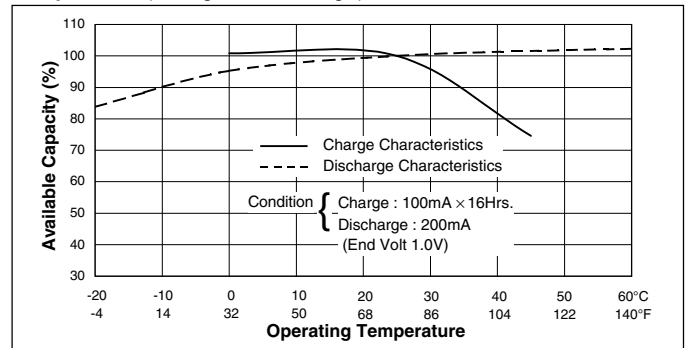

CD010830

Free Manuals Download Website

<http://myh66.com>

<http://usermanuals.us>

<http://www.somanuals.com>

<http://www.4manuals.cc>

<http://www.manual-lib.com>

<http://www.404manual.com>

<http://www.luxmanual.com>

<http://aubethermostatmanual.com>

Golf course search by state

<http://golfingnear.com>

Email search by domain

<http://emailbydomain.com>

Auto manuals search

<http://auto.somanuals.com>

TV manuals search

<http://tv.somanuals.com>