

SANYO

Cadnica

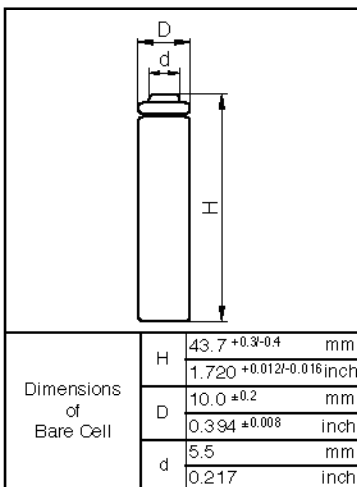

Cell Type N-220AAS Specifications

Nominal Capacity	200mAh	
Nominal Voltage	1.2V	
Standard Charging Current	6.7mA	
Charging Time	above 48Hrs.	
Ambient Temperature	Charge	0°C to +70°C [+32°F to 158°F]
	Discharge	-20°C to +70°C [-4°F to 158°F]
	Storage	-30°C to +70°C [-22°F to 158°F]
Internal Impedance (A _v) (at 50% discharge)	42.0mΩ (at 1000Hz)	
Weight	11g/0.39oz	
Dimensions(D)×(H) (with tube)	10.5 ⁰ _{-0.5} × 44.4 ⁰ ₋₁ mm	
	0.41 ⁰ _{-0.02} × 1.75 ⁰ _{-0.04} inch	

Typical Characteristics

Charge

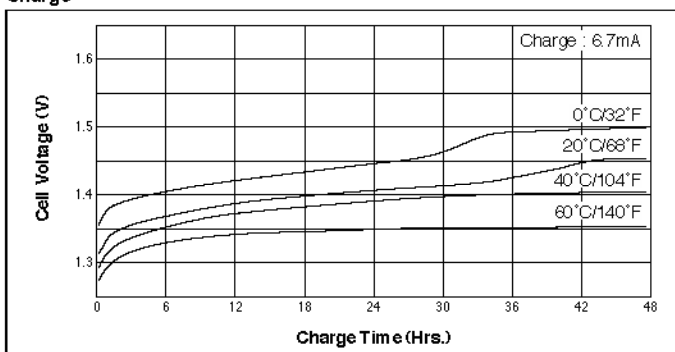

Discharge (at very low rate)

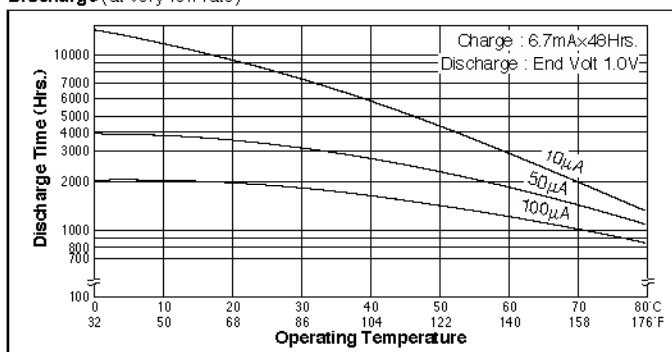

Cell Capacity (at various discharge rate)

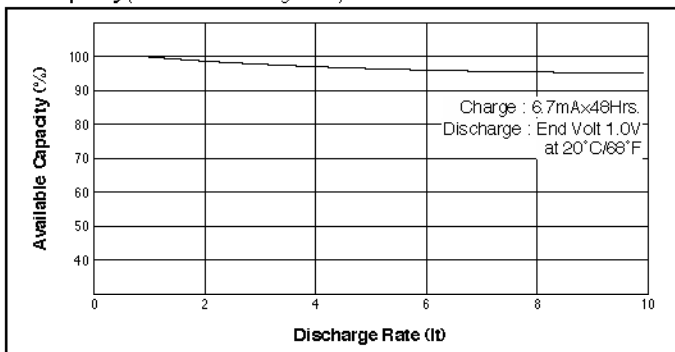

Discharge (at various temperature)

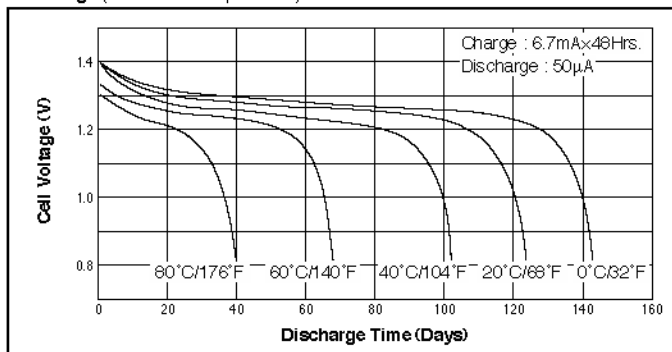

Discharge (at low rate)

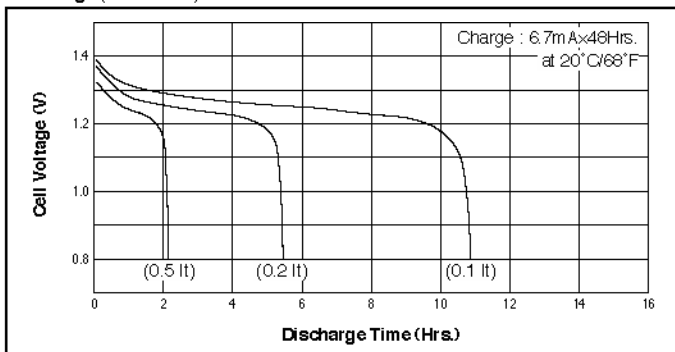

Temperature (Charge & Discharge)

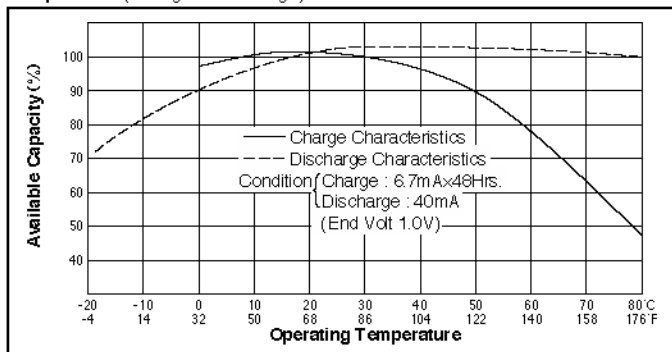

Free Manuals Download Website

<http://myh66.com>

<http://usermanuals.us>

<http://www.somanuals.com>

<http://www.4manuals.cc>

<http://www.manual-lib.com>

<http://www.404manual.com>

<http://www.luxmanual.com>

<http://aubethermostatmanual.com>

Golf course search by state

<http://golfingnear.com>

Email search by domain

<http://emailbydomain.com>

Auto manuals search

<http://auto.somanuals.com>

TV manuals search

<http://tv.somanuals.com>