

# SANYO

## Cadnica

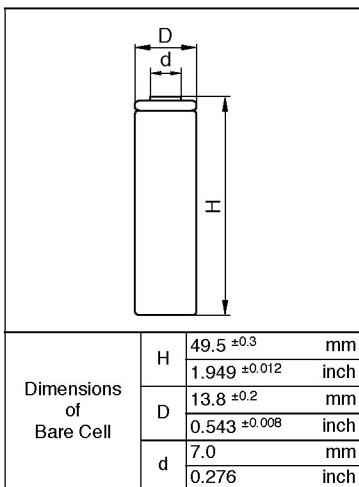

## Cell Type N-550AAS Specifications

Nominal Capacity	500mAh	
Nominal Voltage	1.2V	
Standard Charging Current	17.0mA	
Charging Time	above 48Hrs.	
Ambient Temperature	Charge	0°C to +80°C [+32°F to 176°F]
	Discharge	-20°C to +80°C [-4°F to 176°F]
	Storage	-30°C to +80°C [-22°F to 176°F]
Internal Impedance (Av.) (at 50% discharge)	21.0mΩ (at 1000Hz)	
Weight	22g/0.78oz	
Dimensions(D)×(H) (with tube)	14.3 <sup>0</sup> <sub>-0.5</sub> × 50.2 <sup>0</sup> <sub>-1</sub>	mm
	0.56 <sup>0</sup> <sub>-0.02</sub> × 1.98 <sup>0</sup> <sub>-0.04</sub>	inch

### Typical Characteristics

#### Charge

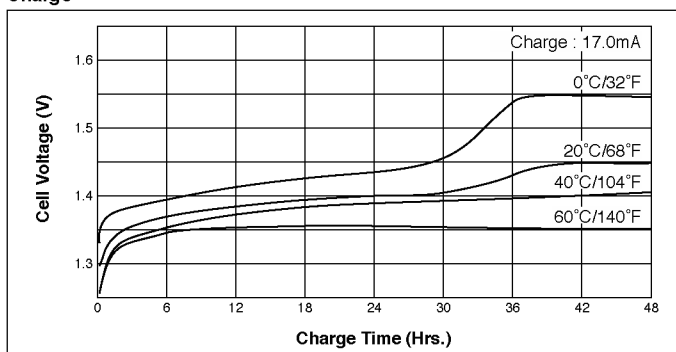

#### Discharge (at very low rate)

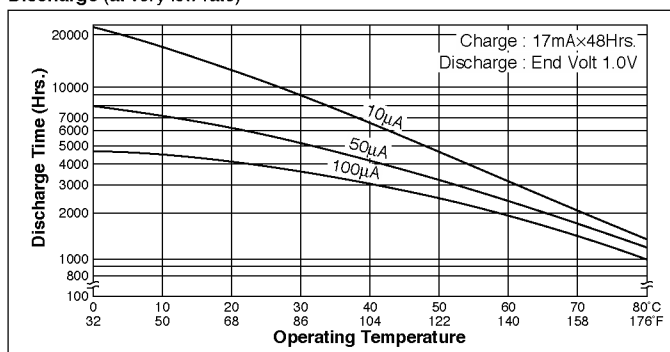

#### Cell Capacity (at various discharge rate)

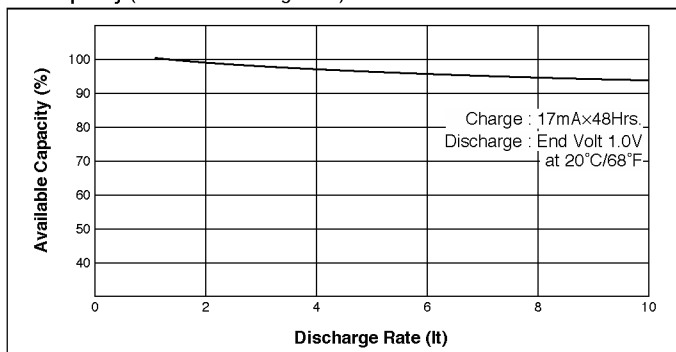

#### Discharge (at various temperature)

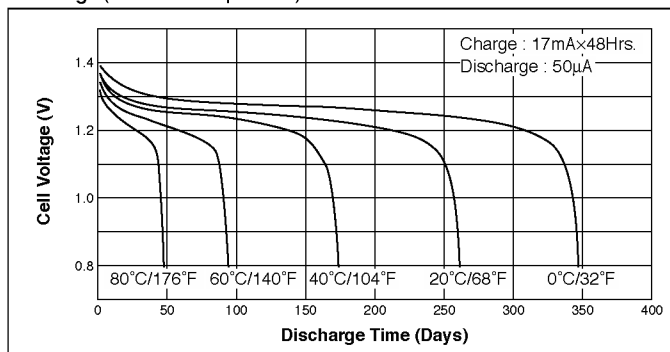

#### Discharge (at low rate)

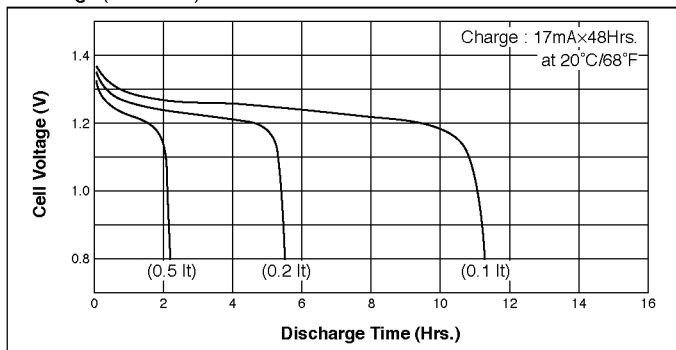

#### Temperature (Charge & Discharge)

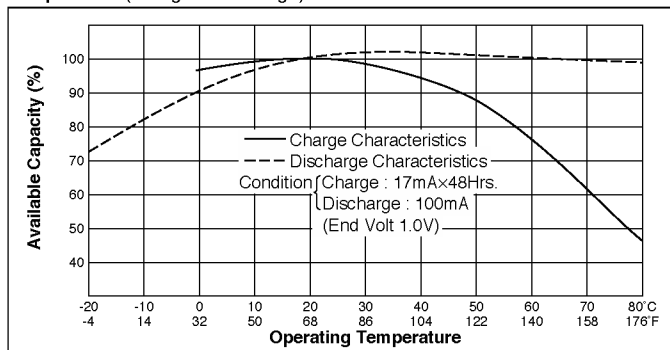

## Free Manuals Download Website

<http://myh66.com>

<http://usermanuals.us>

<http://www.somanuals.com>

<http://www.4manuals.cc>

<http://www.manual-lib.com>

<http://www.404manual.com>

<http://www.luxmanual.com>

<http://aubethermostatmanual.com>

Golf course search by state

<http://golfingnear.com>

Email search by domain

<http://emailbydomain.com>

Auto manuals search

<http://auto.somanuals.com>

TV manuals search

<http://tv.somanuals.com>