

SANYO

Cadnica

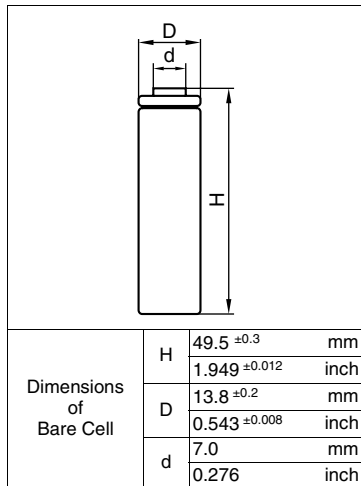
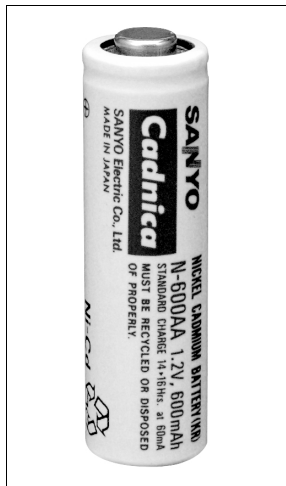

Cell Type N-600AA

Specifications

Nominal Capacity		600mAh	
Nominal Voltage		1.2V	
Charging Current	Standard	60mA	
	Quick	180mA	
	Fast	900mA	
Charging Time	Standard	14 to 16Hrs.	
	Quick	4 to 6Hrs.	
	Fast	about 1Hr.	
Ambient Temperature	Charge	Standard	0°C to +45°C [+32°F to 113°F]
		Quick	10°C to +45°C [+50°F to 113°F]
		Fast	0°C to +45°C [+32°F to 113°F]
	Discharge	-20°C to +60°C [-4°F to 140°F]	
	Storage	-30°C to +50°C [-22°F to 122°F]	
Internal Impedance (Av.) (at 50% discharge)		12.0mΩ (at 1000Hz)	
Weight		23g/0.81oz	
Dimensions(D)×(H) (with tube)		14.3 ⁰ _{-0.5} × 50.2 ⁰ ₋₁ mm	
		0.56 ⁰ _{-0.02} × 1.98 ⁰ _{-0.04} inch	

Typical Characteristics

Charge

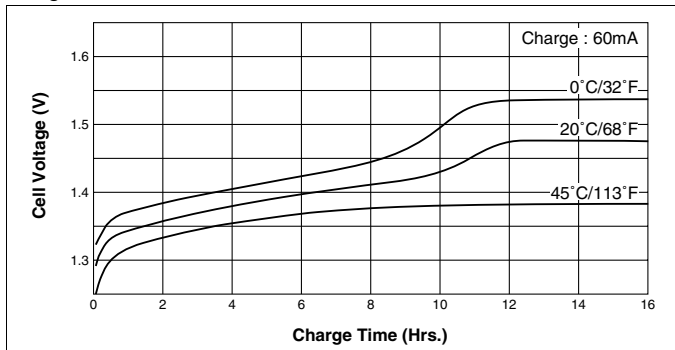

Discharge (at high rate)

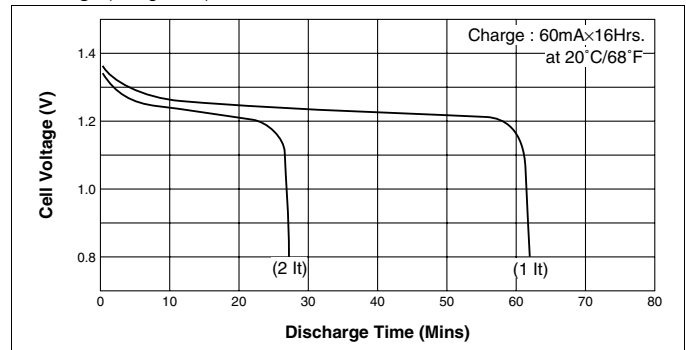

Charge

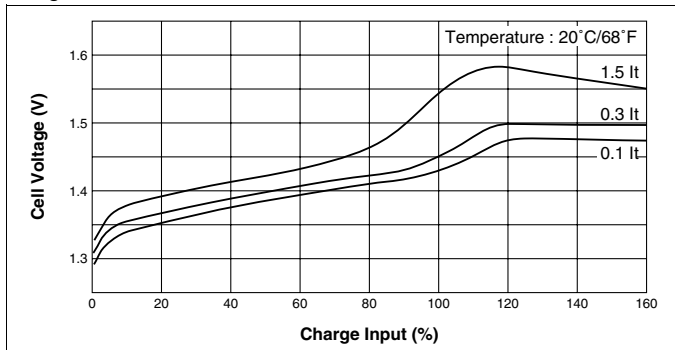

Discharge (at high rate)

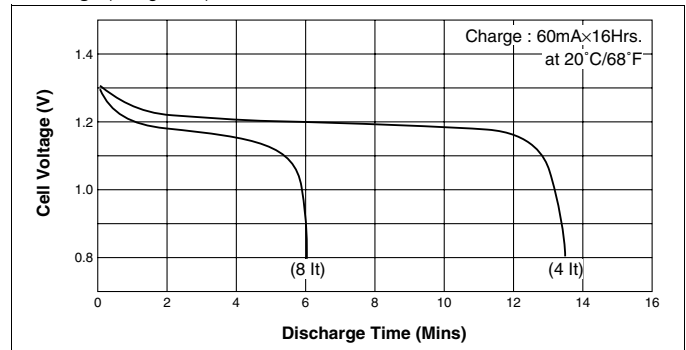

Discharge (at low rate)

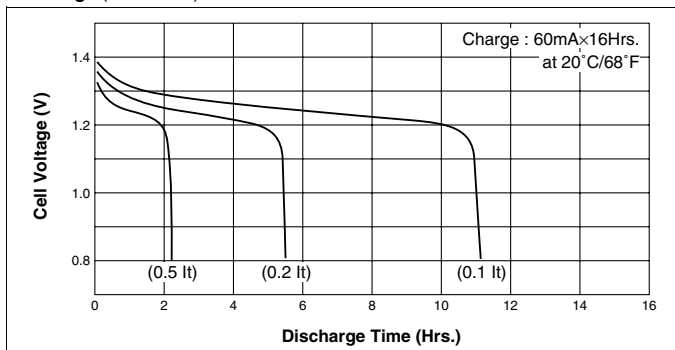

Temperature (Charge & Discharge)

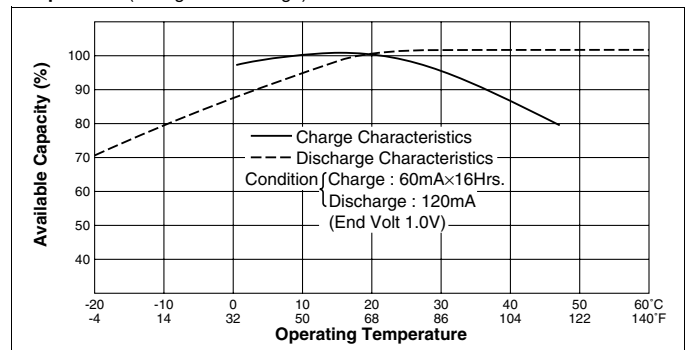

CD010830

Free Manuals Download Website

<http://myh66.com>

<http://usermanuals.us>

<http://www.somanuals.com>

<http://www.4manuals.cc>

<http://www.manual-lib.com>

<http://www.404manual.com>

<http://www.luxmanual.com>

<http://aubethermostatmanual.com>

Golf course search by state

<http://golfingnear.com>

Email search by domain

<http://emailbydomain.com>

Auto manuals search

<http://auto.somanuals.com>

TV manuals search

<http://tv.somanuals.com>