



INSTRUCTION MANUAL

AVL-2610/3210

**26" and 32"* LCD High-definition
Colour TV and Computer Monitor**



* Diagonal measure

**For best TV picture quality and channel selection connect to a digital
cable or satellite receiver**

Help Line: 1-800-263-224
Monday to Friday 9am-5pm (Eastern)

www.sanyo.ca

Table of Contents

Important Information	1
Important Safety Precautions	2
Preparations	5
Identification of Controls	7
Connections.....	10
Basic Operations	15
Memorizing the Channels	17
Setting Picture	18
Setting Sound	19
Setting Timer and System	20
Viewing Closed Caption	22
Setting Parent Control	23
Adjusting On-Screen Display	27
Adjustment in PC (VGA)/YPBPR Mode	28
Troubleshooting.....	29
Care and Maintenance	30
Specifications	31

Important Information

WARNING: TO REDUCE THE RISK OF FIRE OR ELECTRIC SHOCK, DO NOT EXPOSE THIS APPARATUS TO RAIN OR MOISTURE.

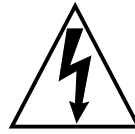
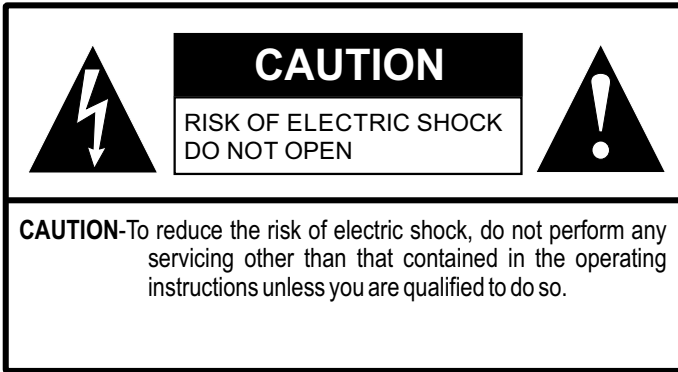

The lightning flash with arrowhead symbol, within an equilateral triangle is intended to alert the user to the presence of uninsulated dangerous voltage within the product's enclosure that may be of sufficient magnitude to constitute a risk of electric shock to persons.



The exclamation point within an equilateral triangle is intended to alert the user to the presence of important operating and maintenance (servicing) instructions in the literature accompanying the appliance.

This product utilizes tin-lead solder, and fluorescent lamp containing a small amount of mercury. Disposal of these materials may be regulated due to environmental considerations. For disposal or recycling information, please contact your local authorities or the Electronic Industries Alliance: www.eia.org

FCC STATEMENT

FCC Notice

LCD TV: A CLASS B digital device

This equipment has been tested and found to comply with the limits for a Class B digital device, pursuant to part 15 of the FCC Rules. These limits are designed to provide reasonable protection against harmful interference when the equipment is operated in a commercial environment.

This equipment generates, uses, and can radiate radio frequency energy and, if not installed and used in accordance with the instruction manual, may cause harmful interference to radio communications. Operation of this equipment in a residential area is likely to cause harmful interference in which case the user will be required to correct the interference at his own expense.

FCC CAUTION:

Pursuant to 47CFR, Part 15.21 of the FCC rules, any changes or modifications to this monitor not expressly approved by the manufacturer could cause harmful interference and would void the user's authority to operate this device.

WARNING: This is a CLASS B product. In a domestic environment this product may cause radio interference in which case the user may be required to take adequate measures to counter interference.

Important Safety Precautions

Electrical energy can perform many useful functions, but it can also cause personal injuries and property damage if improperly handled. This product has been engineered and manufactured with the highest priority on safety. But **IMPROPER USE CAN RESULT IN POTENTIAL ELECTRICAL SHOCK OR FIRE HAZARD**. In order to prevent potential danger, please observe the following instructions when installing, operating and cleaning the product. To ensure your safety and prolong the service life of your LCD TV product, please read the following precautions carefully before using the product.

1. Read these instructions---All operating instructions must be read and understood before the product is operated.

2. Keep these instructions---These safety and operating instructions must be kept in a safe place for future reference.

3. Heed all warnings---All warnings on the product and in the instructions must be observed closely.

4. Follow all instructions---All operating instructions must be followed.

5. Do not use this apparatus near water---for example, near a bathtub, washbowl, kitchen sink, or laundry tub, in a wet basement, or near a swimming pool, and the like.

Do not use immediately after moving from a low temperature to high temperature environment, as this causes condensation, which may result in fire, electric shock, or other hazards.



6. Clean only with dry cloth---Unplug this product from the wall outlet before cleaning. Do not use liquid cleaners or aerosol cleaners. Use a damp cloth for cleaning.

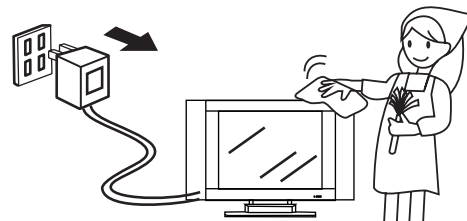

7. Ventilation---Do not block any ventilation openings. Install in accordance with the manufacturer instructions. The vents and other openings in the cabinet are designed for ventilation. Do not cover or block these vents and openings since insufficient ventilation can cause overheating and/or shorten the life of the product. Do not place the product on a bed, sofa, rug or other similar surface, since they can block ventilation openings. This product is not designed for built-in installation; do not place the product in an enclosed place such as a bookcase or rack, unless proper ventilation is provided or the manufacturer's instructions are followed.

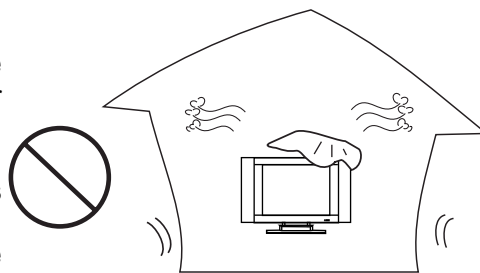

8. Heat sources---Do not install near any heat sources such as radiators, heat registers, stoves, or other apparatus (including amplifiers) that produce heat.

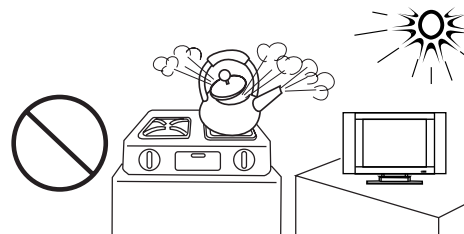

9. Grounding or Polarization---Do not defeat the safety purpose of the polarized or grounding-type plug. A polarized plug has two blades with one wider than the other. A grounding type plug has two blades and a third grounding prong. The wide blade or the third prong are provided for your safety. If the provided plug does not fit into your outlet, consult an electrician for replacement of the obsolete outlet.

10. Power cord protection---Protect the power cord from being walked on or pinched particularly at plugs, convenience receptacles, and the point where they exit from the apparatus.

NOTE: where the mains plug or an appliance coupler is used as the disconnect device, the disconnect device shall remain readily operable.

11. Attachments---Only use attachments/accessories specified by the manufacturer. Do not use attachments not recommended by the manufacturer. Use of improper attachments can result in accidents.

Important Safety Precautions (continued)

12. Stand---Use only with the cart, stand, tripod, bracket, or table specified by the manufacturer, or sold with the apparatus. Do not place the product on an unstable trolley, stand, tripod or table. Placing the product on an unstable base can cause the product to fall, resulting in serious personal injuries as well as damage to the product. When mounting the product on a wall, be sure to follow the manufacturer's instructions. Use only the mounting hardware recommended by the manufacturer.

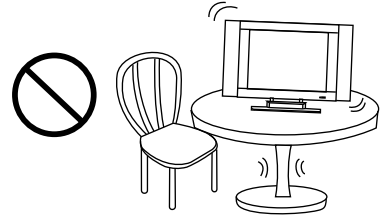

13. Move carefully---When a cart is used, use caution when moving the cart/apparatus combination to avoid injury from tip-over. Sudden stops, excessive force and uneven floor surfaces can cause the product to fall from the trolley. Never attempt to move the TV unless the AC power cord has been disconnected.



14. Lightning---Unplug this apparatus during lightning storms or when unused for long periods of time.

For added protection for this television equipment during a lightning storm, or when it is left unattended and unused for long periods of time, unplug it from the wall outlet and disconnect the antenna. This will prevent damage to the equipment due to lightning and power-line surges.

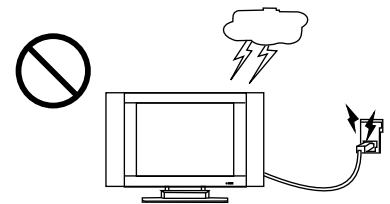

15. Servicing---Refer all servicing to qualified service personnel. Servicing is required when the apparatus has been damaged in any way, such as power-supply cord or plug is damaged, liquid has been spilled or objects have fallen into the apparatus, the apparatus has been exposed to rain or moisture, does not operate normally, or has been dropped.

16. Replacement parts---In case the product needs replacement parts, make sure that the service person uses replacement parts specified by the manufacturer, or those with the same characteristics and performance as the original parts. Use of unauthorized parts can result in fire, electric shock and/or other danger.

17. Overloading---Do not overload wall outlets, extension cords, or convenience receptacles on other equipment as this can result in a risk of fire or electric shock.

18. Entering of objects and liquids---Never insert an object into the product through vents or openings. High voltage flows in the product, and inserting an object can cause electric shock and/or short internal parts. For the same reason, do not spill water or liquid on the product.

19. Damage requiring service---If any of the following conditions occurs, unplug the power cord from the AC outlet, and request a qualified service person to perform repairs.

- When the power cord or plug is damaged.
- When a liquid is spilled on the product or when objects have fallen into the product.
- When the product has been exposed to rain or water.
- When the product does not operate properly as described in the operating instructions.

Do not touch the controls other than those described in the operating instructions. Improper adjustment of controls not described in the instructions can cause damage, which often requires extensive adjustment work by a qualified technician.

- If the product has been dropped or the cabinet has been damaged in any way.
- When the product displays an abnormal condition or exhibits a distinct change in performance. Any noticeable abnormality in the product indicates that the product needs servicing.

20. Safety checks---Upon completion of service or repair work, request the service technician to perform safety checks to ensure that the product is in proper operating condition.

21. Wall or ceiling mounting---When mounting the product on a wall or ceiling, be sure to install the product according to the method recommended by the manufacturer. This is a safety feature.

Important Safety Precautions (continued)

22. Power source---This product is intended to be supplied by a listed power supply indicated on the marking label. If you are not sure of the type of power supply to your home, consult your product dealer or local power company. For added protection for this product during a lightning storm, or when it is left unattended and unused for long periods of time, unplug it from the wall outlet and disconnect the cable system. This will prevent damage to the product due to lightning and power line surges. When the unit has to be used with another power supply voltage, the power cable must be changed. Consult your product dealer. The socket outlet should be installed near the equipment and easily accessible. Use only the power cord designated by our dealer to ensure safety and EMC. When connecting other products such as VCRs and personal computers, you should turn off the power of the unit for protection against electric shock.

23. Panel protection---The LCD panel used in this product is made of glass. Therefore, it can break when the product is dropped or impacted upon by other objects. Be careful not to be injured by broken glass pieces in case the LCD panel breaks.

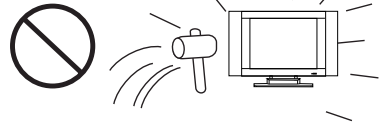

24. Pixel defect---The LCD panel is a very high technology product, giving you finely detailed pictures. Occasionally, a few non-active pixels may appear on the screen as a fixed point of blue, green or red. Please note that this does not affect the performance of your product.

WARNING: For continued safety, apparatus with class I construction shall be connected to a mains socket outlet with a protective earthing connection.

Preparations

Using the Remote Control

- Use the remote control by pointing it towards the remote sensor window of the set. Objects between the remote control and sensor window may prevent proper operation.

Note: This illustration is for reference only. The remote sensor may be in different locations on different models.

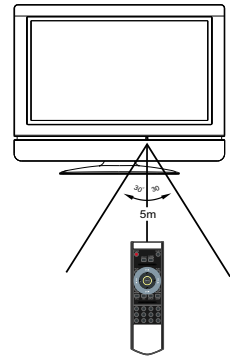

Cautions regarding use of remote control

- Do not expose the remote control to shock. In addition, do not expose the remote control to liquids, and do not place in an area with high humidity.
- Do not install or place the remote control under direct sunlight. The heat may cause deformation of the unit.
- The remote control may not work properly if the remote sensor window of the main unit is under direct sunlight or strong lighting. In such a case, change the angle of the lighting or LCD TV set, or operate the remote control closer to the remote sensor window.

Batteries for the Remote Control

If the remote control fails to operate the LCD TV functions, replace the batteries in the remote control.

1 Open the battery cover.

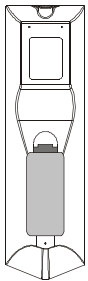

2 Insert two size-AAA batteries.

- (Place the batteries with their terminals corresponding to the (+) and (-) indications in the battery compartment.)

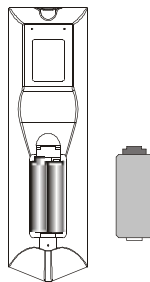

3 Replace the cover.

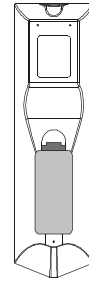

Precaution on battery use

Improper use of batteries can result in a leakage of chemicals and/or explosion. Be sure to follow the instructions below.

- Place batteries with their terminals corresponding to the (+) and (-) indications.
- Different types of batteries have different characteristics. Do not mix batteries of different types.
- Do not mix old and new batteries. Mixing old and new batteries can shorten the life of new batteries and/or cause old batteries to leak chemicals.
- Remove batteries as soon as they are non-operable. Chemicals that leak from batteries can cause a rash. If chemical leakage is found, wipe with a cloth.
- If the remote control is not used for an extended period of time, remove the batteries from the remote control.

Speaker connection

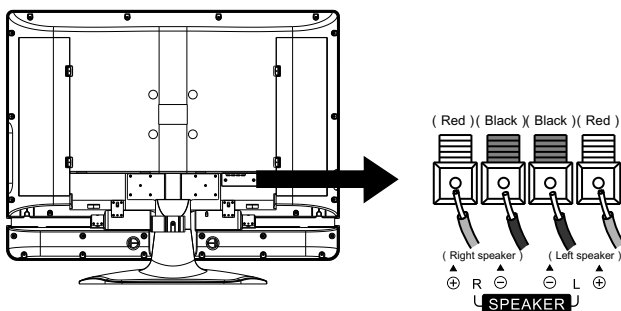

Connect the speaker audio cable to the external speaker output jack on the unit matching the "+" and "-" ends of the cable with color.

Note:

- ▶ Unplug the LCD display and all connected component before connecting the Speakers.
- ▶ The illustration may be different depending on model.

Preparations (continued)

Antenna Connection

CABLE TV (CATV) CONNECTION

A 75-ohm coaxial cable connector is built into the set for easy hookup. When connecting the 75-ohm coaxial cable to the set, screw the 75-ohm cable to the ANT. Terminal.

Some cable TV companies offer "premium pay channels". Since the signals of these premium pay channels are scrambled, a cable TV converter/descrambler is generally provided to the subscriber by the cable TV company.

This converter/descrambler is necessary for normal viewing of the scrambled channels. For more specific instructions on installing cable TV, consult your cable TV company. One possible method of utilizing the converter/descrambler provided by your cable TV company is explained below. Please note: An RF switch provided with two inputs (A and B) is required (not supplied).

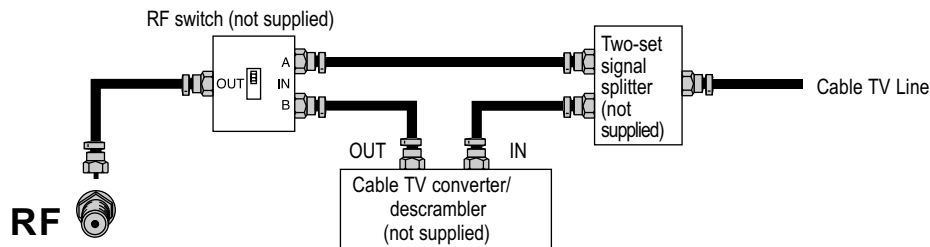

"A" position on the RF switch (not supplied) : You can view all unscrambled channels by using the TV's channel keys.

"B" position on the RF switch (not supplied) : You can view the scrambled channels via the converter/descrambler by using the converter's channel keys.

Note:

Consult your Dealer or Service Center for the type of splitter, RF switch or combiner that might be required.

ANTENNAS

The antenna requirements for good color television reception are more important than those for black & white television reception. For this reason, a good quality outdoor antenna is strongly recommended.

The following is a brief explanation of the type of connections that are provided with the various antenna systems.

1. A 75-ohm system is generally a round cable with F-type connector that can easily be attached to a terminal without tools (not supplied).
2. A 300-ohm system is a flat "twin-lead" cable that can be attached to a 75-ohm terminal through a 300-75-ohm adapter (not supplied).

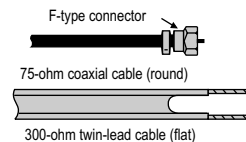

OUTDOOR ANTENNA CONNECTION

Use one of the following two diagrams if you connect an outdoor antenna.

A: Using a VHF/UHF combination outdoor antenna.

B: Using separate VHF and/or UHF outdoor antennas.

Connect the outdoor antenna cable lead-in to the ANT. terminal on the rear of the TV set.

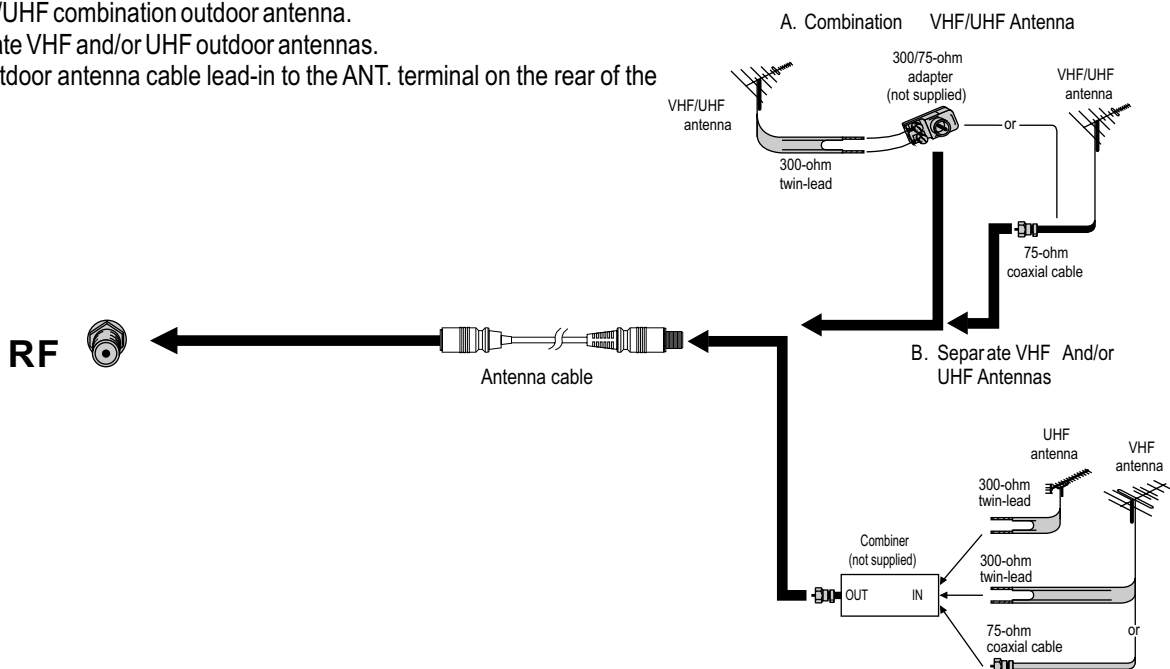

Identification of Controls

Main Unit (front view)

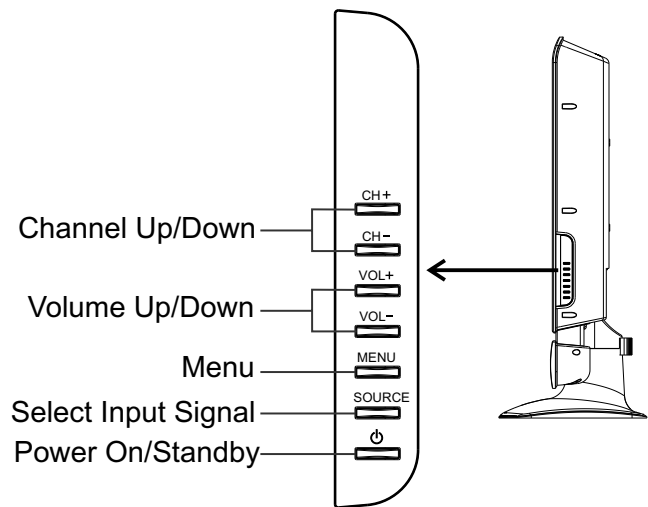
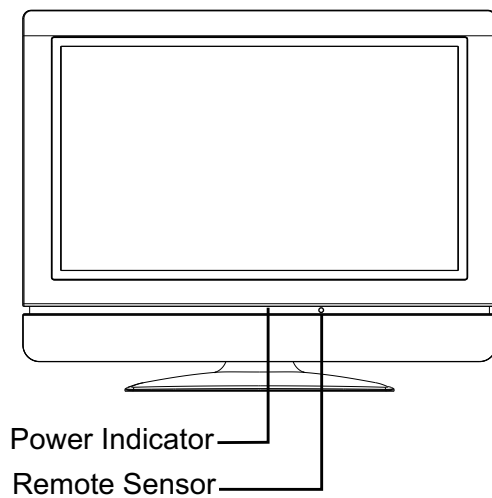

1. POWER

Press this button to turn the unit ON from STANDBY mode. Press it again to turn the set back to STANDBY.

2. SOURCE

To access signal source select menu

3. MENU

Press this button to access the Menu main page.

4. VOL+/-

Press the **VOL+** or **VOL-** button to directly increase or decrease the sound volume level;
In OSD Menu, press these buttons to adjust the value or setting of each item.

5. CH+/-

Press these two buttons to directly change the TV channel;
In OSD Menu, press these buttons to choose the OSD items.

Note:

Functions of **VOL+/-**, **CH+/-**, **MENU**, **SOURCE** and **POWER**  are also provided to the remote control. This operation manual provides a description based on operating functions with the remote control.

Identification of Controls (continued)

Main Unit (rear view)

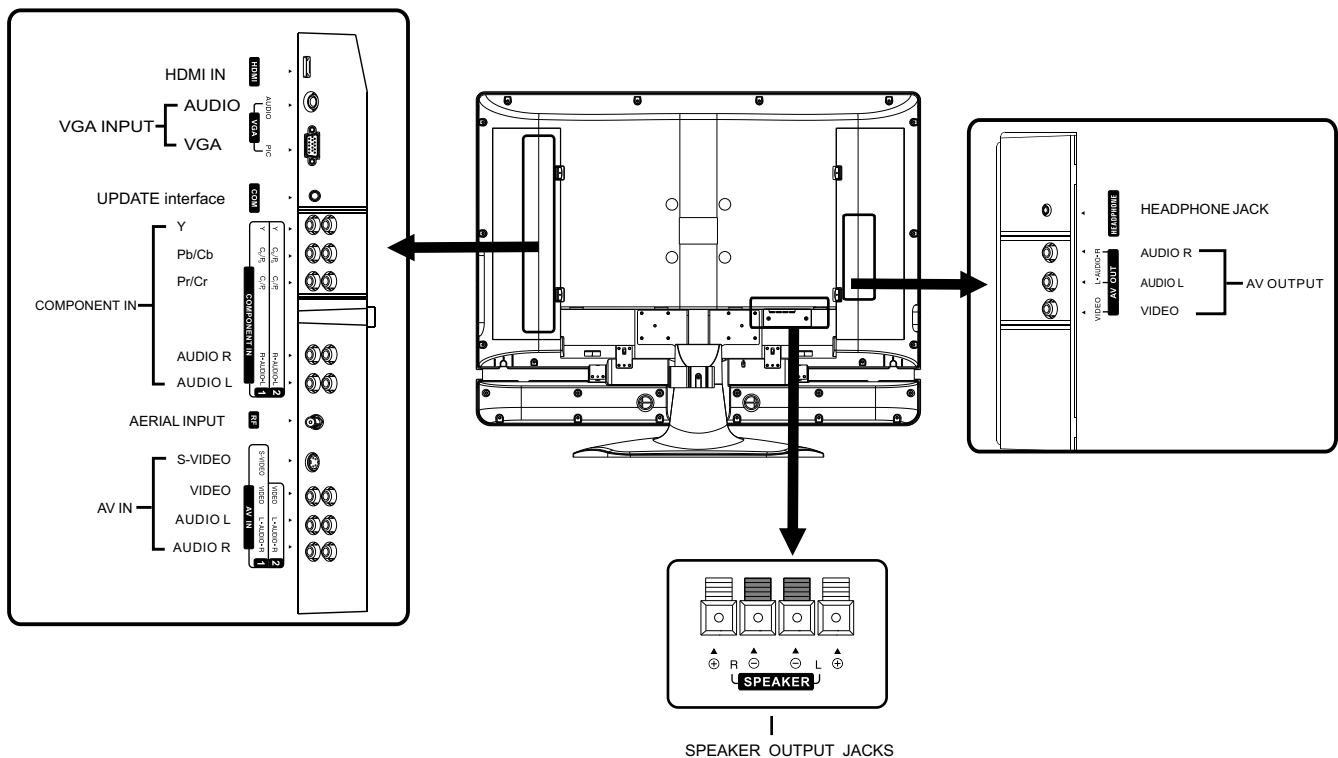

1. HDMI interface

2. VGA input/Audio in

Connect to the VGA /audio output sockets on your PC.

3. COM port

For service only. The user cannot operate the unit through the COM port.

4. Component inputs

Connect to the component and audio output sockets of a DVD player or Set-Top Box.

5. Antenna input

Allows you to connect cable or outdoor antenna.

6. AV inputs (S-Video, Video, Audio L, R)

Receive video/audio signals from external sources such as VCR or DVD player.

7. Headphone jack

8. AV outputs (Video, Audio L, R)

Connect to the VCR input jacks to record programs.

9. Speaker Output jacks

Note: Before you connect external devices with the unit, please remove the back cover firstly.

Identification of Controls (continued)

Remote Control



- 1. POWER** Turn the unit on or off
- 2. SOURCE** To access source select menu
- 3. ADJUST** To rectify the picture automatically in PC mode
- 4. MUTE** To temporarily mute the sound
- 5. CH+/- (▲ / ▼), VOL+/- (◀ / ▶) , MENU**
CH+/- (▲ / ▼)
 To select channels upward or downward; to move upward or downward in menu operation;
VOL+/- (◀ / ▶)
 Used to adjust volume
MENU button: To access or exit the menu main page.
- 6. SOUND** To select the sound mode
- 7. STILL** To freeze current picture
- 8. MTS** To select STEREO, SAP or MONO
- 9. 0-9 NUMBER**
 Use these number buttons to select channel or input password
- 10. CLOSED CAPTION** To select closed caption mode
- 11. SCALE** To select screen aspect ratio
- 12. PICTURE** To select the picture mode
- 13. SLEEP** To set sleep timer
- 14. DISPLAY** To display channel status or signal information
- 15. NR** To select the noise reduction mode
- 16. RETURN** To quickly return to the previous channel

Connections

Cautions before connecting

- Carefully check the terminals for position and type before making any connections.
- The illustration of the external equipment may be different depending on your model.
- Loose connectors can result in image or colour problems. Make sure that all connectors are securely inserted into their terminals.
- Refer to the operating manual of the external device as well.
- When connecting an external device, turn the power off to avoid any issues.

Connect a VCR

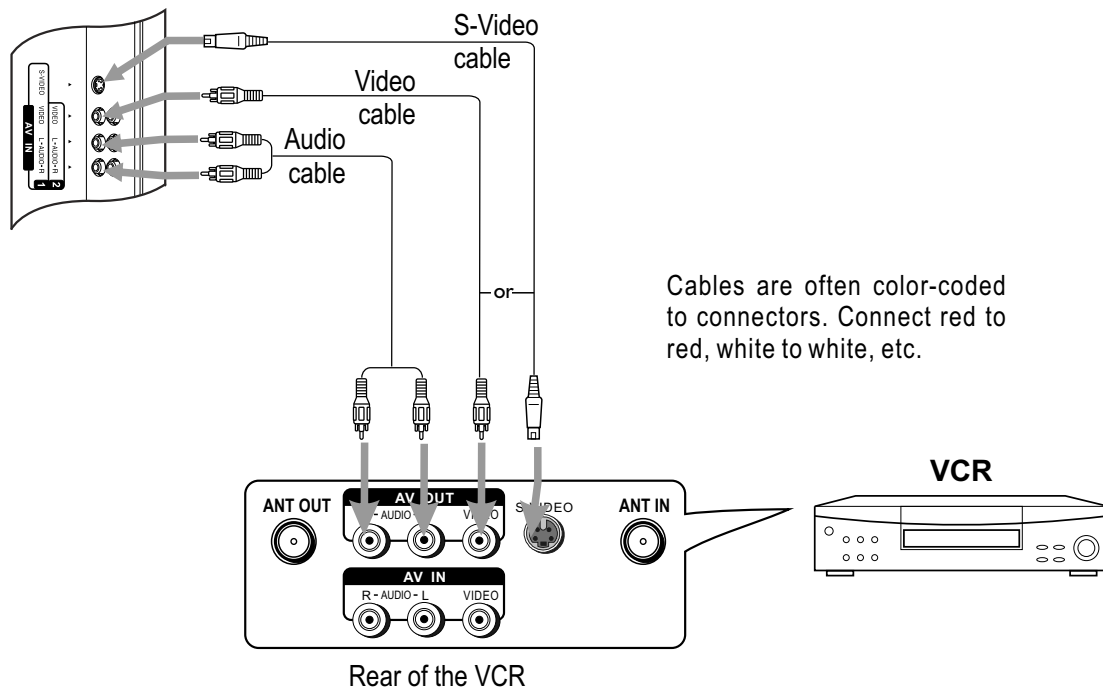

The unit provides two groups of Audio/Video inputs for you to connect external devices such as VCR, Video Camera or Home video game system.

How to connect:

Connect the Audio/Video cables between the Audio (L/R)/Video jacks on the unit and external devices.

To view signal from AV/S-VIDEO inputs

1. Turn on your TV, press **SOURCE** button on the remote control.
2. Use **▲** or **▼** repeatedly to select **AV1** (or **SVIDEO** if the S-Video terminal is connected) and press **◀** or **▶** to confirm.
3. Turn on the external device and play it.

Note:

For better video, you can use the **S-Video** terminal if your source supports it.

The **Video** input terminal on the **AV1 IN** and the **S-Video** input terminal share the same **Audio** input terminals.

SOURCE
PC
HDMI
TV
AV1
AV2
SVIDEO
YPBPR1
YPBPR2
←ADJ

Connections (continued)

Connect a Camcorder

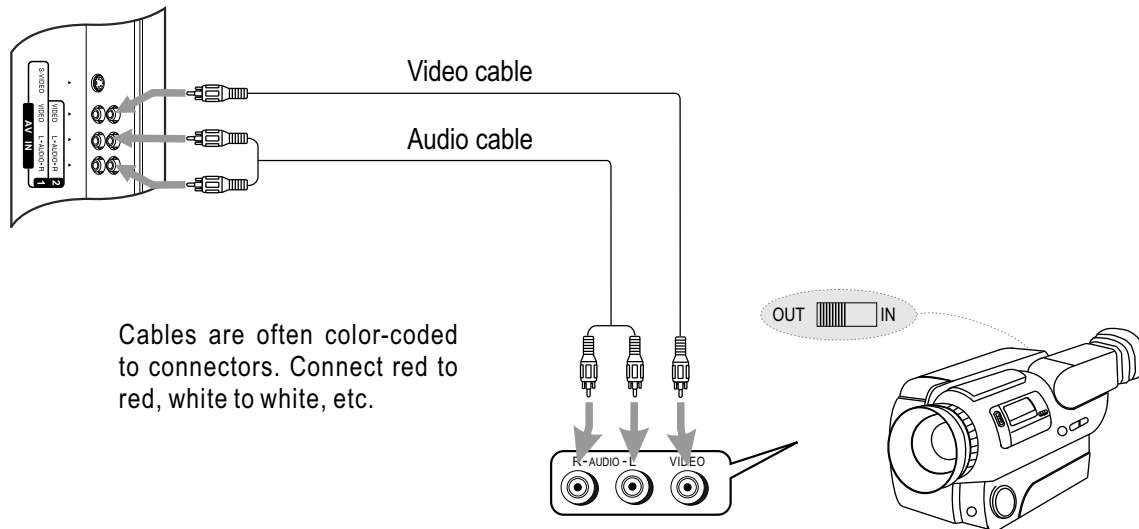

How to connect:

Connect the Audio/Video cables between the Audio (L/R)/Video jacks on the unit and camcorder.

To playback Camcorder

1. Turn on your TV, press **SOURCE**  button on the remote control.
2. Press **▲** or **▼** repeatedly to select **AV2**, and press **◀** or **▶** to confirm.
3. Turn on your camcorder and set it to output mode. (For details, refer to your camcorder user manual.)
4. Insert the tape into the camcorder and press Play button.

Note:

The operations of the camcorder may be different and is dependant on your model. Please read the user manual of your camcorder to confirm operation.

SOURCE

PC
HDMI
TV
AV1
AV2
SVIDEO
YPBPR1
YPBPR2

 ADJ

Connections (continued)

Connect a DVD player or Set-Top Box

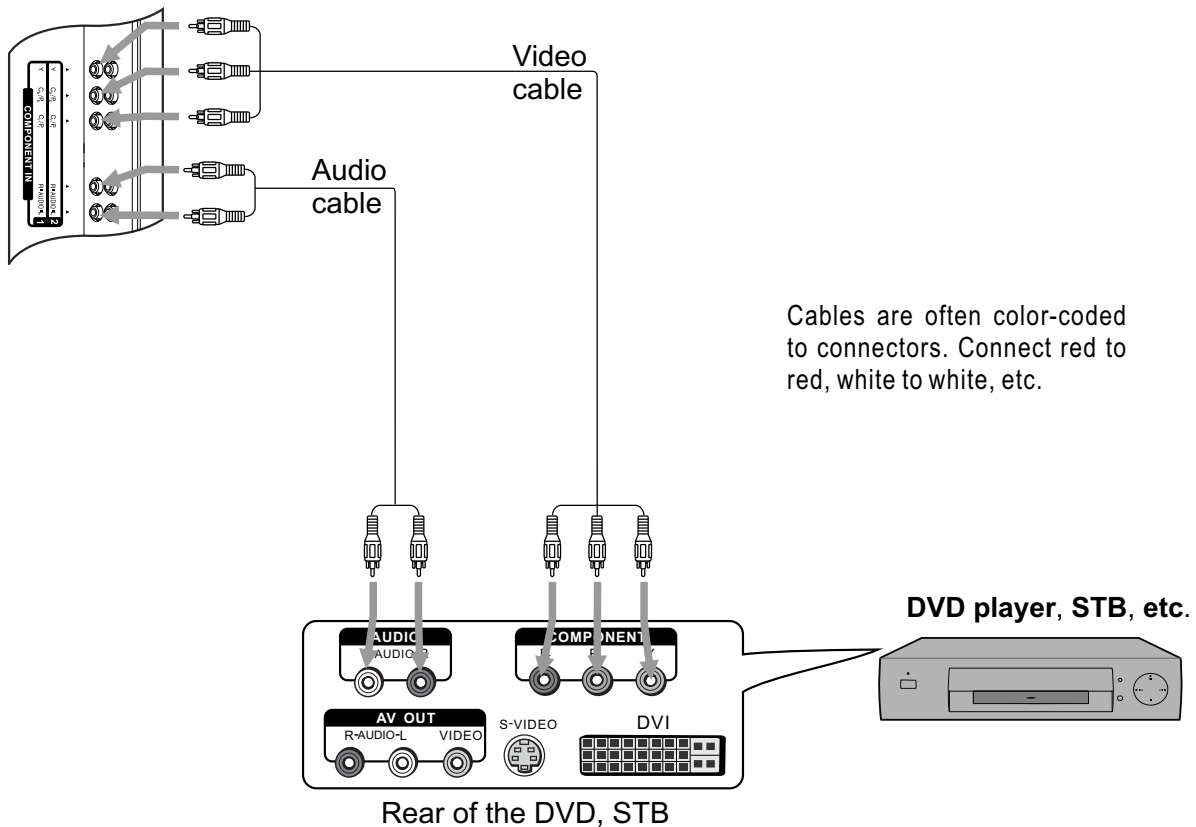

How to connect a DVD Player using Component Video Connections:

Connect the Video cable between the Y, Cb/Pb, Cr/Pr input jacks on the unit and Y, Pb, Pr output jacks on the DVD player. Connect the Audio cable between the AUDIO input jack on the unit and AUDIO output jacks on the DVD player.

To play DVD

1. Turn on your TV, press **SOURCE**  button on the remote control.
2. Press **▲** or **▼** repeatedly to select **YPBPR1** or **YPBPR2**, and press **◀** or **▶** to confirm.
3. Turn on your DVD player, insert a DVD disc and press the Play button.

SOURCE

PC
HDMI
TV
AV1
AV2
SVIDEO
YPBPR1
YPBPR2

↔:ADJ

Note:

The Y, Pb, Pr outputs on your DVD player are sometimes labeled Y, Cb, Cr or Y, B-Y, R-Y. If so, connect the cables to like colours.

Connections (continued)

Connect a HDMI device

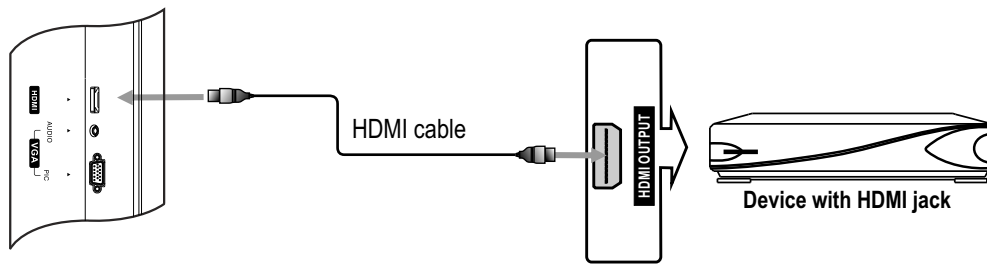

How to connect:

Connect the HDMI cable between the HDMI input jack on the unit and HDMI output jack on the device.

Note:

If the external device has DVI output only, use a DVI to HDMI adapter cable to connect to the HDMI jack. Connect the audio cable to the VGA AUDIO IN jack on the TV rear.

To Play the Device

1. Turn on your TV, press **SOURCE**  button on the remote control.
2. Press **▲** or **▼** repeatedly to select **HDMI** and press **◀** or **▶** to confirm.
3. Turn on your device.

SOURCE

PC
HDMI
TV
AV1
AV2
SVIDEO
YPBPR1
YPBPR2

↔:ADJ

Connect a PC

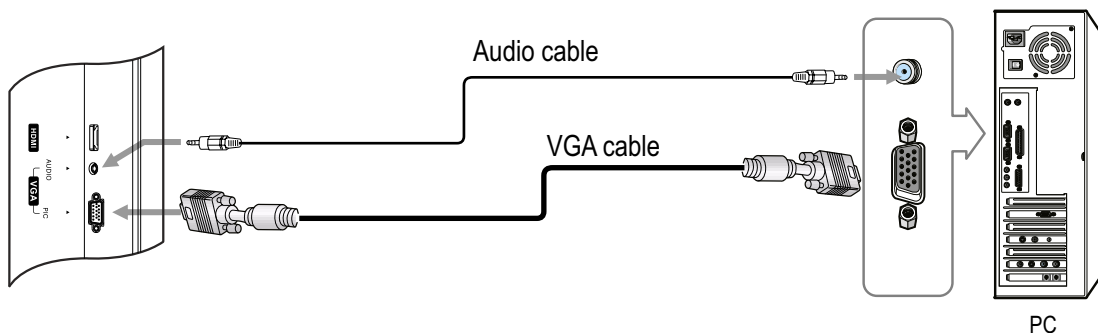

How to connect:

Connect a VGA cable between the VGA interface on the PC and the VGA interface on the unit.

Connect an Audio cable between the AUDIO output on the PC and AUDIO input socket on the unit.

To Watch the PC screen

1. Turn on your TV, press **SOURCE**  button on the remote control.
2. Press **▲** or **▼** repeatedly to select **PC** and press **◀** or **▶** to confirm.
3. Turn on your PC and check for PC system requirements.
4. Adjust the PC screen.

SOURCE

PC
HDMI
TV
AV1
AV2
SVIDEO
YPBPR1
YPBPR2

↔:ADJ

Connections (continued)

Connect a VCR (for recording) or external amplifier

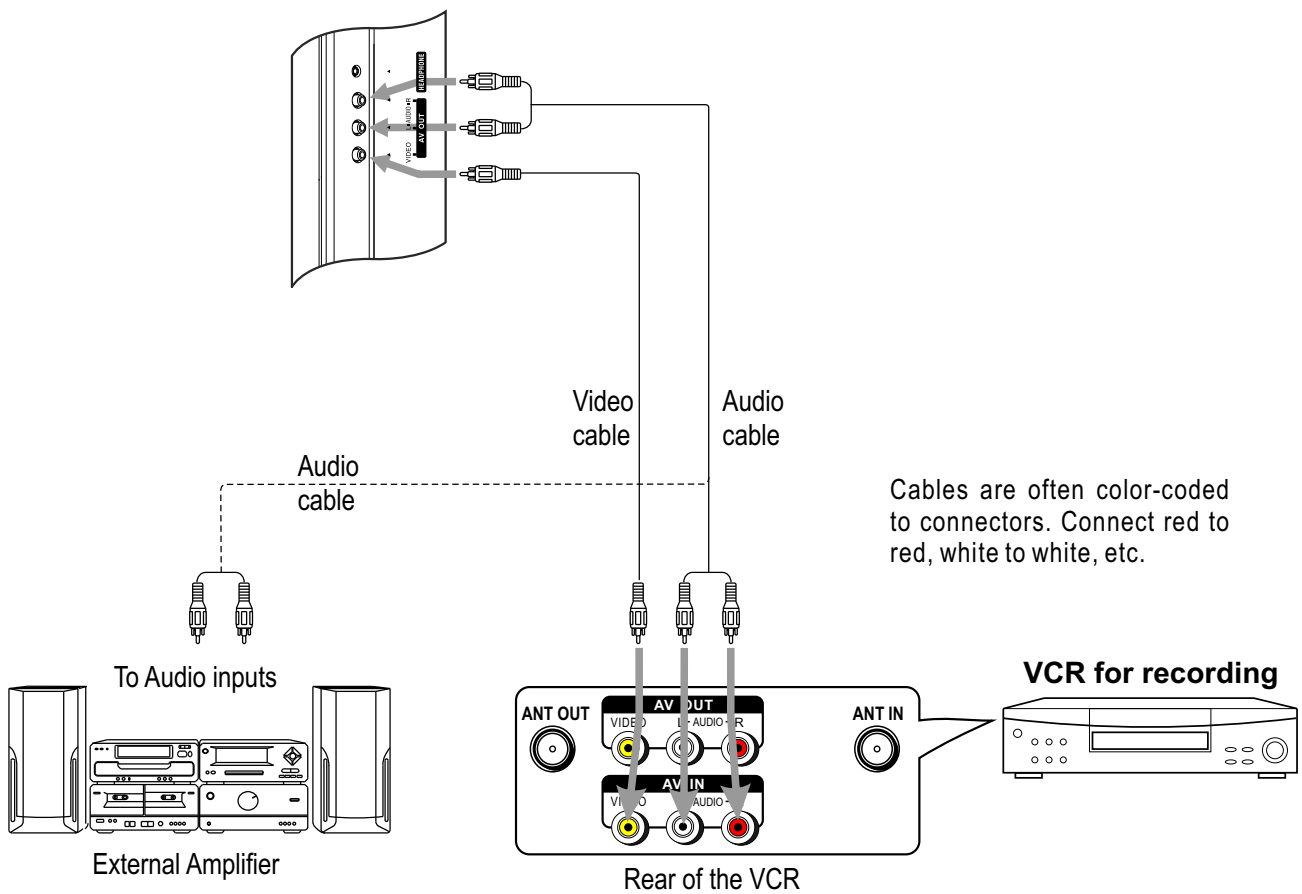

How to connect:

Connect the Audio/Video cables between the Audio (L/R)/Video jacks on the unit and VCR.

- or -

Connect the Audio cables between the Audio (L/R) jacks on the unit and external amplifier.

To record program

1. Turn on your TV, select a program you wish to record.
2. Turn on your VCR, insert a videotape for recording.
3. Press the Record button to begin recording.

To enjoy high-quality sound through an external amplifier

Note:

The operations of the amplifier may be different depending on model. Please read the user manual of your amplifier to confirm proper operation.

Only analog TV programs, AV1, AV2 and SVIDEO input sources can be output through the AV output jacks.

Basic Operations

Turning the Unit On and Off

Turning On

Insert the power cord into the wall outlet.

Press the **Power** ⏻ button on the remote control, the unit will be turned on and you will be ready to use its features.

Turning Off

With the power on, press the **Power** ⏻ button on the remote control to turn off the unit.

Note:

You can also use the **Power** ⏻ button on the Control panel on the main unit.

After you turn off the television, you should wait for some seconds to turn the television on again.

Viewing the Menus and Displays

This unit has a simple, easy-to-use menu system that appears on the screen. This system makes it convenient and fast to use features on the unit. The unit also lets you display the status of many of your TV features.

Viewing the Menus

- 1 With the power on, press the **MENU** button on the remote control. The main menu appears on the screen.
- 2 Press ◀ or ▶ to select menu page, and press ▼ to access.
- 3 Use the ▲ or ▼ to select menu item and ◀ or ▶ to adjust value or setting of the item.
- 4 Press **MENU** button repeatedly to exit.



Note:

To clearly introduce the menu operations, this operation manual provides a description based on operation with the remote control.

Displaying Status Information

Press the **DISPLAY** button on the remote control, the unit will display current status information such as channel number, audio mode or signal source, etc.

Basic Operations (continued)

Changing Channels

Using the Channel Buttons (CH+ or CH-)

Press the **CH+** or **CH-** to change channels.

When you press the **CH+** or **CH-**, the unit changes channels in sequence. You will see all the channels that the unit has memorized. You will not see channels that were skipped.

Direct Accessing Channels

Press the **number buttons** to go directly to a channel.

To select a one-digit channel: input the channel number by pressing the **0-9 number buttons** to display X--, and wait for some seconds the unit goes to the selected channel.

To select a two-digit channel: input the channel number by pressing the **0-9 number buttons** to display XX-, and wait for some seconds the unit goes to the selected channel.

To select a three-digit channel: input the channel number by pressing the **0-9 number buttons** to display XXX, and the unit goes to the selected channel at once.

Note:

"X" is 0-9 number.

When you use the number buttons, you can directly select channels that were skipped.

Using the RETURN (↶) button

Press this button to switch between the current channel and the previous channel.

Selecting Input Source Signal

1 Press the **SOURCE**  button to display the **SOURCE** menu.

2 Press **▲** or **▼** to select a desired input source.

3 Press **◀** or **▶** to confirm.

PC -----Select signal from VGA jack.

HDMI-----Select signal from HDMI terminal.

TV-----Select TV signal.

AV1-----Select signal from AV IN 1 terminals.

AV2-----Select signal from AV IN 2 terminals.

SVIDEO-----Select signal from S-Video terminal.

YPBPR1-----Select signal from COMPONENT IN 1 terminals.

YPBPR2-----Select signal from COMPONENT IN 2 terminals.

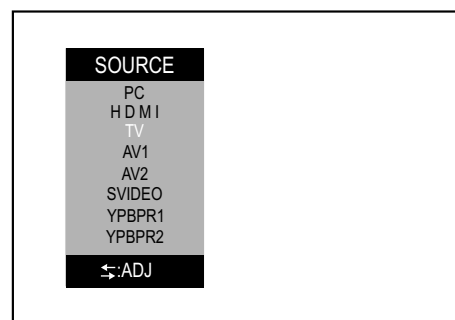

Selecting a Menu Language

1 Press **MENU** to display the menu main page.

2 Press **◀** or **▶** repeatedly to select **OSD** menu.

3 Press **▼** to access the menu.
The [**OSD LANGUAGE**] item will be highlighted automatically.

4 Press **◀** or **▶** to select a desired OSD language.

5 Press **MENU** button repeatedly to exit.



Memorizing the Channels

Your TV can memorize and store all of the available channels. After the available channels are memorized, use CH+/- to scan through the channels.

Selecting the TV Source

Before you start **AUTO SCAN**, it is necessary to specify the type of signal source that is connect to the unit. (i.e., an antenna or cable system).

- 1 Press **MENU** to display the menu main page.
- 2 Press ◀ or ▶ repeatedly to select **TV-CHANNEL** menu, and press ▼ to access. Then the **[SOURCE]** item will be highlighted automatically.
- 3 Press ◀ or ▶ to select **AIR** or **CABLE** item.
In **AIR** mode, the set receives antenna signal.
In **CABLE** mode, the set receives cable TV program.
- 4 Press **MENU** button repeatedly to exit.

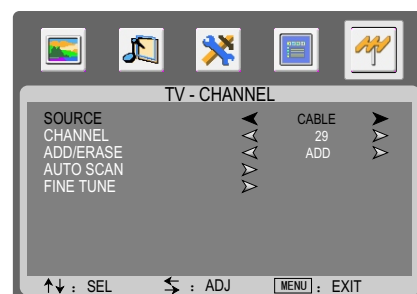

Searching Channels Automatically

- 1 Navigate to the **TV-CHANNEL** menu, and highlight **AUTO SCAN** item.
- 2 Press ◀ or ▶ to begin the auto channel search. The unit will begin memorizing all of the available channels.

Note: During the process of the Auto Scan, you can press **MENU** button to stop the search.

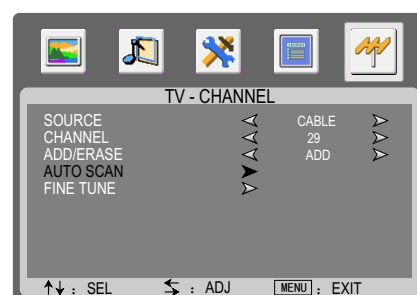

Skipping Channels

- 1 Navigate to the **TV-CHANNEL** menu, and highlight **CHANNEL** item.
- 2 Press ◀ or ▶ to select a channel you want to skip.
- 3 Press ▼ to select **ADD/ERASE** item.
- 4 Use ◀ or ▶ to select **ADD** or **ERASE**.
When the item is set to **ERASE**, the selected channel will be skipped.
When the item is set to **ADD**, the selected channel will not be skipped.
- 5 Press **MENU** button repeatedly to exit.

The skipped channels can not be selected by using CH+/- buttons unless you use number buttons to input channel number directly.

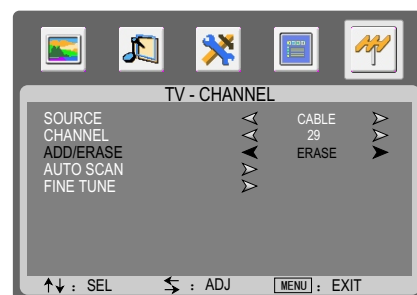

Manual Fine Tuning

- 1 Select a channel you want to perform fine tuning.
- 2 Navigate to the **TV-CHANNEL** menu, and press ▲ or ▼ repeatedly to select **FINE TUNE** item.
- 3 Press ◀ or ▶ to start the fine tune till the best possible picture and sound are obtained.

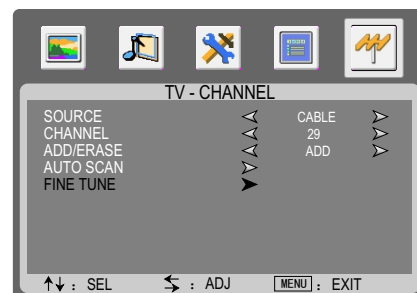

Setting Picture

Customizing the Picture

- 1 Press **MENU** to display the **PICTURE** menu , and press **▼** to access.
- 2 Within the menu, use **▲** , **▼** , **◀** or **▶** to navigate or adjust.
- 3 Press **MENU** button repeatedly to exit.

Notes: The **PICTURE MENU** is shown as an example.
The menu options may be different when the unit works in different mode.



Option	Function	Choice/remarks
Contrast	Adjusts image contrast.	▶ : stronger ◀ : weaker
Brightness	Adjusts screen brightness for easier viewing of dark picture such as night scenes and black hair.	▶ : lighter ◀ : darker
Tint	Adjusts tint for image.	▶ : greenish ◀ : purplish
Saturation	Adjusts color saturation.	▶ : stronger ◀ : weaker
Sharpness	Adjusts image sharpness and displays a sharp image.	▶ : sharper ◀ : softer
Color Tone	Selects one of three automatic color adjustments. Sets to warm to enhance hotter colors such as red, or set to cool to see less intense colors with more blue.	Normal/Warm/Cool
Scale	Adjusts screen aspect ratio.	Normal/Panorama/Full/Zoom1/Zoom2 Note: you may directly press SCALE button on the remote control to select.
Picture Mode	Selects a desired picture mode.	Standard/Movie/Vivid/User Note: you may directly press PICTURE button on the remote control to select.
3D NR	Reduces noise in the picture, commonly called snow.	Low/Mid/High/Off

Note: The Tint item is for NTSC system.

The scale item cannot be adjusted when there is no input signal or the picture is freezed.

Freezing picture

Press the **STILL** button to hold on the image on the screen (the video sources still run).
Press it again to reactivate the image.

Note: For the sake of protecting the screen, please do not freeze a picture for a long time.

Setting Sound

Adjusting the Volume

Using the volume buttons (VOL+ and VOL-)

Press the **VOL +** or **VOL-** to increase or decrease the volume.

Using the MUTE button

At any time, you can temporarily cut off the sound using the **MUTE** button.

- 1 Press the **MUTE** button and the sound cuts off.
- 2 To turn mute off, press the **MUTE** button again.

Customizing the Sound

- 1 Press **MENU** to display the menu main page.
- 2 Press **◀** or **▶** repeatedly to select **SOUND** menu, and press **▼** to access.
- 3 Within the menu, use **▲**, **▼**, **◀** or **▶** to navigate or adjust.
- 4 Press **MENU** button repeatedly to exit.

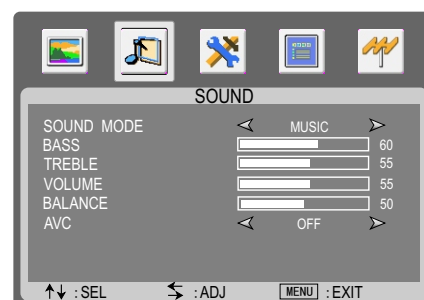

Option	Function	Choice/Remarks
Sound Mode	Selects sound mode.	User/Standard/Movie/Music Note: you may directly press SOUND button on the remote control to select.
Bass	Adjusts Bass (low sounds)	▶ : stronger ◀ : weaker
Treble	Adjusts Treble (high sounds)	▶ : stronger ◀ : weaker
Volume	Adjusts volume	▶ : stronger ◀ : weaker
Balance	Adjusts volume balance (left and right volumes)	▶ : Higher volume from right speaker. ◀ : Higher volume from left speaker.
AVC (Auto Volume Control)	Select "ON" to equalize overall volume levels across all channels.	ON/OFF

Setting Timer and System

Setting Clock Time

Making use of this function can set the current time for the TV.

- 1 Press **MENU** to display the menu main page.
- 2 Press **◀** or **▶** repeatedly to select **FUNCTION** menu, and Press **▼** to access. Then the [**CLOCK**] item will be highlighted automatically.
- 3 Use **0-9 number** buttons to input the current time.
- 4 Press **MENU** button repeatedly to exit.

Note: Before setting the **ON TIMER** and **OFF TIMER**, please set the **CLOCK** item first.

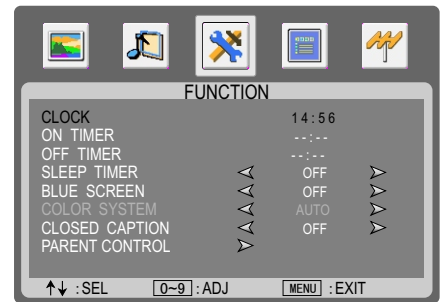

Notes: The above menu is shown as an example. The menu items may be different when the unit works in different mode.

Setting ON timer

With the ON timer, the TV will automatically turn on at a preset time.

- 1 Press **MENU** to display the menu main page.
- 2 Press **◀** or **▶** repeatedly to select **FUNCTION** menu, and press **▼** to access.
- 3 Press **▲** or **▼** repeatedly to select **ON TIMER** item.
- 4 Use **0-9 number** buttons to input the time value.
- 5 Press **MENU** button repeatedly to exit.

Note: The TV must be in STANDBY mode for the ON TIMER to work.

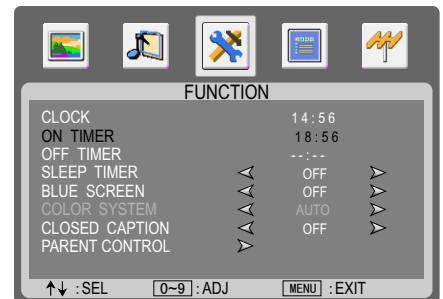

Setting OFF timer

With the OFF timer, the TV will automatically turn off at a preset time.

- 1 Press **MENU** to display the menu main page.
- 2 Press **◀** or **▶** repeatedly to select **FUNCTION** menu, and press **▼** to access.
- 3 Press **▲** or **▼** repeatedly to select **OFF TIMER** item.
- 4 Use **0-9 number** buttons to input time value.
- 5 Press **MENU** button repeatedly to exit.

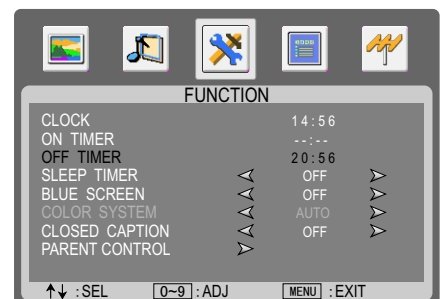

POWER DOWN: 21

Note:

The time interval between CLOCK and OFF TIMER should be above 1 minute. When the last 1 minute comes, the unit will remind you after how many seconds the set will be turned off. During this period if you do not want the unit to be turned off, press any button to exit. If the TV loses power, the clock and timer settings will be cleared and must be reset.

Setting Timer and System (continued)

Setting Sleep Timer

Making use of this function allows you to have the set automatically turn off after a preset time.

- 1 Press **MENU** to display the menu main page.
- 2 Press ◀ or ▶ repeatedly to select **FUNCTION** menu, and press ▼ to access.
- 3 Press ▲ or ▼ repeatedly to select **SLEEP TIMER** item.
- 4 Use ◀ or ▶ to select the amount of time; to turn off the timer, please select **OFF**.
- 5 Press **MENU** button repeatedly to exit.

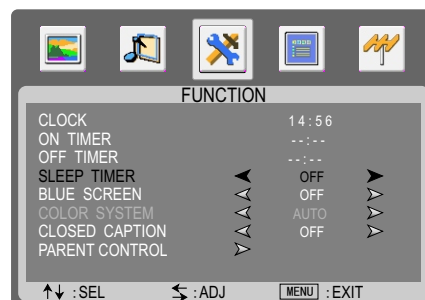

Note: You may quickly set the sleep timer by using the **SLEEP** button on the remote control.

Setting Blue Screen

- 1 Press **MENU** to display the menu main page.
- 2 Press ◀ or ▶ repeatedly to select **FUNCTION** menu, and press ▼ to access.
- 3 Press ▲ or ▼ repeatedly to highlight **BLUE SCREEN** item.
- 4 Press ◀ or ▶ to select **ON** or **OFF**.
- 5 Press **MENU** button repeatedly to exit.

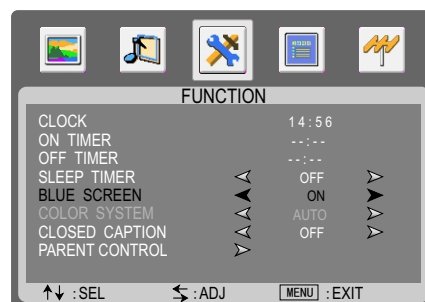

Note: When there is no TV signal input, a blue background appears if you set this item to **ON**.
In TV mode, when there is still no signal input for a certain time, the TV set auto goes to STANDBY mode.

Setting Color System

- 1 Press **MENU** to display the menu main page.
- 2 Press ◀ or ▶ repeatedly to select **FUNCTION** menu, and press ▼ to access.
- 3 Press ▲ or ▼ repeatedly to highlight **COLOR SYSTEM** item.
- 4 Press ◀ or ▶ to select a proper color system (normally please select **AUTO**).
- 5 Press **MENU** button repeatedly to exit.

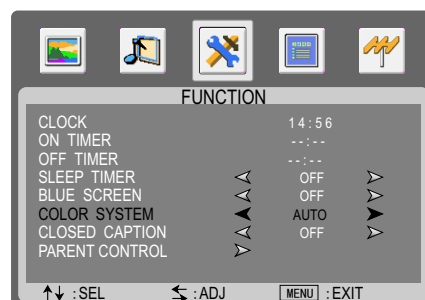

Note: The color system item is adjustable only in **AV1**, **AV2** and **SVIDEO** mode.
In normal circumstances, please set the color system to **AUTO**, and the set can automatically select the proper color system. If the color is still abnormal, then select the proper color system manually.

Viewing Closed Captions

This TV has the capability to decode and display Closed Captioned television programs. Closed Caption will display text on the screen for hearing impaired viewers or it will translate and display text in another language.

Note:

The caption feature only works in TV, AV1, AV2 and SVIDEO modes.

Not all the programs and videos will offer closed captioning.

Setting Closed Caption

- 1 Press **MENU** to display the menu main page.
- 2 Press **◀** or **▶** repeatedly to select **FUNCTION** menu, and press **▼** to access.
- 3 Press **▲** or **▼** repeatedly to highlight **CLOSED CAPTION** item.
- 4 Press **◀** or **▶** to select a desired option. To turn off closed captioning, please select **OFF**.
- 5 Press **MENU** button repeatedly to exit.

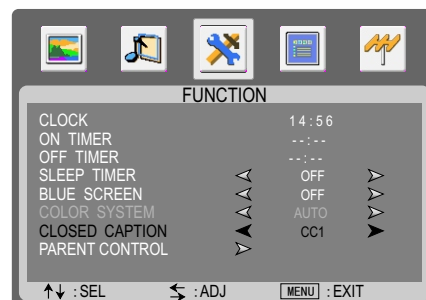

You may select between CC1, CC2, CC3, CC4, TEXT1, TEXT2, TEXT3, TEXT4 and ON MUTE.

The Closed Caption broadcasts can be viewed in two modes: CAPTION and TEXT. For each mode, four channels are available.

The [CAPTION] mode shows subtitles of dialogues and commentaries of video programs while allowing a clear view of the picture.

The [TEXT] mode displays various information over the picture (such as TV program schedule, weather forecast, etc.) that is independent of the video programs.

When **ON MUTE** is selected, the unit will automatically display closed caption when you mute the sound.

Note: You can also use **CLOSED CAPTION** button on the remote control to select a desired caption mode.

Setting Parental Control

Parental Control

This function allows TV programs to be restricted and TV usage to be controlled based on FCC data. It prevents children from watching violent or sexual scenes that may be harmful.

Restriction of TV programs includes two ratings that contain information about the program: the MPAA rating and the TV Parental Guidelines. The MPAA rating is restricted by age. TV Parental Guidelines are restricted by age and content.

Since a TV program may use either the MPAA rating or the TV Guidelines, both should be adjusted for complete control.

[1] Movie Rating (MPAA)

Rating		
age based	G	GENERAL AUDIENCES. All ages admitted.
	PG	PARENTAL GUIDANCE SUGGESTED. Some material may not be suitable for children.
	PG-13	PARENTAL STRONGLY CAUTIONED. Some material may be inappropriate for children under 13.
	R	RESTRICTED. Under 17 requires accompanying parent or adult guardian.
	NC-17	NO ONE 17 AND UNDER ADMITTED.
	X	X Rating is an older rating that is unified with NC-17 but may be encoded in the data of older movies.
	NONE	NOT RATED.

Note:

The Movie rating is only age-based.

Example 1:

"PG-13" in the age-based rating is blocked, this will automatically block the higher ratings: "R", "NC-17", "X" also.

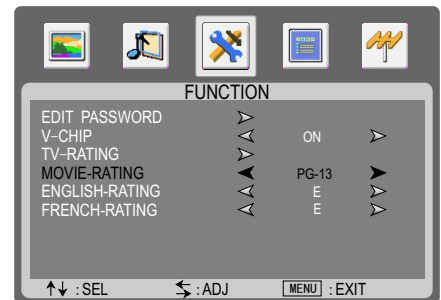

Example 2:

"R" in the age-based rating is blocked, this will automatically block the higher rating: "NC-17", "X" also.

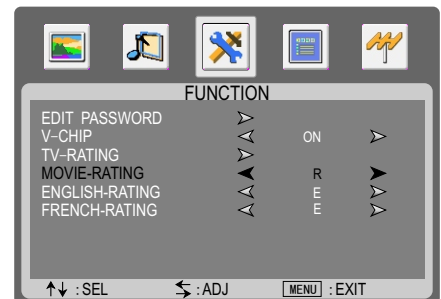

Setting Parental Control (continued)

[2] TV Rating

Rating		← content based →				
		D	V	S	L	FV
age based	TV-Y (All children)	×	×	×	×	×
	TV-Y7 (Direct to Older Children)	×	×	×	×	●
	TV-G (General Audience)	×	×	×	×	
	TV-PG (Parental Guidance Suggested)	●	●	●	●	
	TV-14 (Parents Strongly Cautioned)	●	●	●	●	
	TV-MA (Mature Audience Only)		●	●	●	

- × — Content Rating can be set but this Rating is not normally broadcast by TV Station.
 - — Content Rating can be set.
- D: Sexually Suggestive Dialog
 V: Violence
 S: Sexual Situation
 L: Adult Language
 FV: Fantasy Violence

Note:

Age-based ratings can be modified by the content-based ratings but only in the combinations indicated by an ● in the table above. Choosing lower age-based rating blocks the higher age-based ratings regardless of content ratings settings.

Example 1:

When TV-Y in the age-based rating is set to BLOCK, this will automatically block the higher ratings: TV-Y7, TV-G, TV-PG, TV-14 and TV-MA.

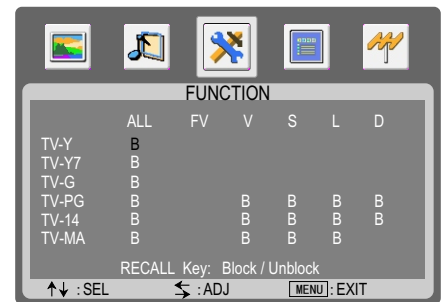

Example 2:

When TV-G in the age-based rating is set to BLOCK, this will automatically block the higher ratings: TV-PG, TV-14, TV-MA.

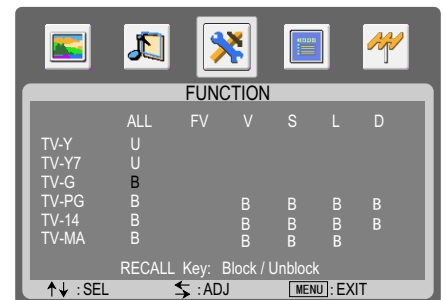

Setting Parental Control (continued)

The Parental Control function enables parents to prevent their children from watching inappropriate programs on TV. To use Parental Control function, you first need to set your password.

Password Setup

- 1 Press **MENU** to display the menu main page.
- 2 Press **◀** or **▶** repeatedly to select **FUNCTION** menu, and press **▼** to access.
- 3 Use **▲** or **▼** repeatedly to select **PARENT CONTROL** item, and then press **◀** or **▶** to access. Now a password is required to input.
- 4 Use **0-9 number** buttons to input the password (four digit, the default password is "0000") to enter into the next-level menu. Then the **[EDIT PASSWORD]** item will be highlighted automatically, and press **◀** or **▶** to access.
- 5 Use 0-9 number buttons to input the new password.
- 6 Input the new password again and then the password has been changed successfully.
- 7 Press **MENU** button repeatedly to exit.

Note:

Be sure to write down your new password and retain it for future use. If you forget the password, the unit provides a super password as "2580" for you to access the locked channels or change password.

Please **DO NOT** let the children know the super password.

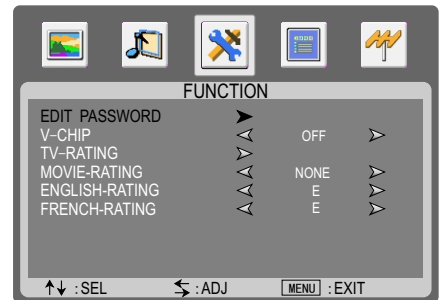
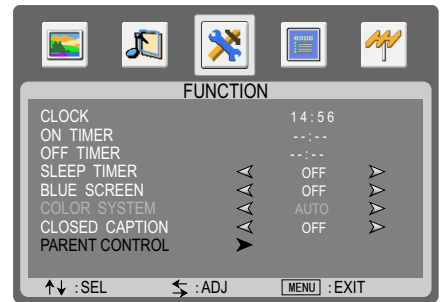

V-Chip Setup

- 1 Input password to navigate to **PARENT CONTROL** sub-menu, press **▲** or **▼** repeatedly to select the **V-CHIP**.
- 2 Press **◀** or **▶** to select **ON** or **OFF**. Before you start rating setup, you must first set **V-CHIP** to **ON**.

When the **V-CHIP** item is set to **OFF**, all the rating blocks will be released.

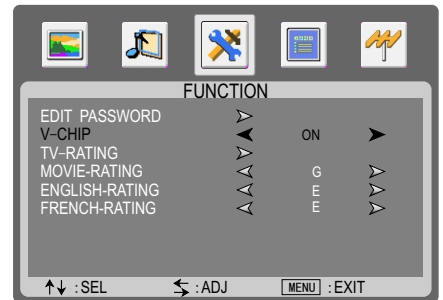

TV Rating Setup

- 1 Input password to navigate to **PARENT CONTROL** sub-menu, press **▲** or **▼** repeatedly to select the **TV-RATING** item, and then use **◀** or **▶** to access.
- 2 Within the menu, use **▲**, **▼**, **◀** or **▶** to navigate, and press **RETURN** (↻) button on the remote control to block or unblock the rating.

When TV-Y in the age-based rating is set to **BLOCK**, this will automatically block the higher ratings: TV-Y7, TV-G, TV-PG, TV-14 and TV-MA.

When TV-G in the age-based rating is set to **BLOCK**, this will automatically block the higher ratings: TV-PG, TV-14, TV-MA.

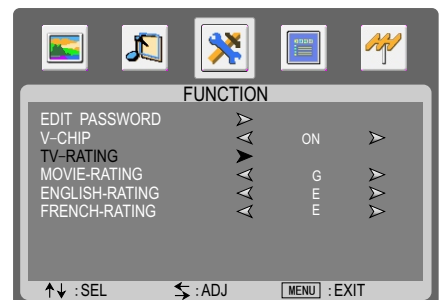

MPAA Rating Setup

- 1 Input password to navigate to **PARENT CONTROL** sub-menu, press **▲** or **▼** repeatedly to select the **MOVIE-RATING** item.
- 2 Use **◀** or **▶** to select a rating that you would like to set.

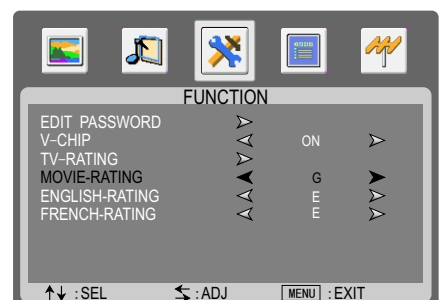

Setting Parental Control (continued)

Canadian English Rating Setup

- 1 Input password to navigate to **PARENT CONTROL** sub-menu, press **▲** or **▼** to highlight the **ENGLISH-RATING** item.
- 2 Use **◀** or **▶** to select a desired rating that you would like to set.

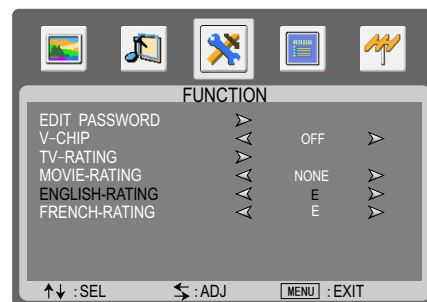

CANADIAN ENGLISH RATING CHART

E	Exempt - Exempt programming includes: news, sports, documentaries and other information programming, talk shows, music videos, and variety programming.
C	Programming intended for children under age 8. No offensive language, nudity or sexual content.
C8+	Programming generally considered acceptable for children 8 years and over. No profanity, nudity or sexual content.
G	General programming, suitable for all audiences.
PG	Parental Guidance suggested. Some material may not be suitable for children.
14+	Programming contains themes or content which may not be suitable for viewers under the age of 14. Parents are strongly cautioned to exercise discretion in permitting viewing by pre-teens and early teens.
18+	Intended for viewers 18 years and older and might contain depictions of violence.

Canadian French Rating Setup

- 1 Input password to navigate to **PARENT CONTROL** sub-menu, press **▲** or **▼** to highlight the **FRENCH-RATING**.
- 2 Use **◀** or **▶** to select a desired rating that you would like to set.

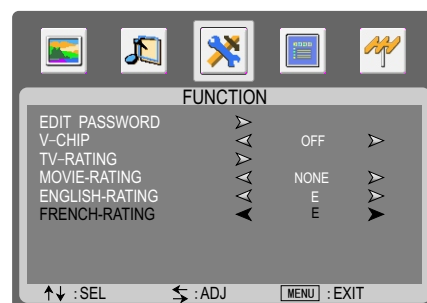

CANADIAN FRENCH RATING CHART

E	Exempt - Exempt programming.
G	General - Programming intended for audience of all ages. Contains no violence, or the violence content is minimal or is depicted appropriately.
8 ANS+	8+ General - Not recommended for young children. Programming intended for a broad audience but contains light or occasional violence. Adult supervision recommended.
13 ANS+	Programming may not be suitable for children under the age of 13 - Contains either a few violent scenes or one or more sufficiently violent scenes to affect them. Adult supervision strongly suggested.
16 ANS+	Programming may not be suitable for children under the age of 16 - Contains frequent scenes of violence or intense violence.
18 ANS+	Only for adult viewing. Could contain frequent violent scenes and extreme violence.

Adjusting On-Screen Display

Adjusting OSD Position

- 1 Press **MENU** to display the menu main page.
- 2 Press **◀** or **▶** repeatedly to select **OSD** menu, and press **▼** to access.
- 3 Press **▲** or **▼** repeatedly to select **OSD H-POSITION** or **OSD V-POSITION**.
- 4 Press **◀** or **▶** to adjust the OSD position.



Adjusting OSD Halftone

- 1 Press **MENU** to display the menu main page.
- 2 Press **◀** or **▶** repeatedly to select **OSD** menu, and press **▼** to access.
- 3 Press **▲** or **▼** repeatedly to select **OSD HALFTONE** item.
- 4 Press **◀** or **▶** to adjust the OSD halftone.



Setting OSD Timeout

This setting allows you to set the time for the main OSD menu to be displayed on screen.

- 1 Press **MENU** to display the menu main page.
- 2 Press **◀** or **▶** repeatedly to select **OSD** menu, and press **▼** to access.
- 3 Press **▲** or **▼** repeatedly to highlight **OSD DURATION** item.
- 4 Press **◀** or **▶** select a proper time.



Adjustment in PC (VGA)/YPBPR Mode

Adjusting the Picture

- 1 Press **MENU** to display the **PICTURE** menu , and press **▼** to access.
- 2 Within the menu, use **▲** , **▼** , **◀** or **▶** to navigate or adjust.
- 3 Press **MENU** button repeatedly to exit.

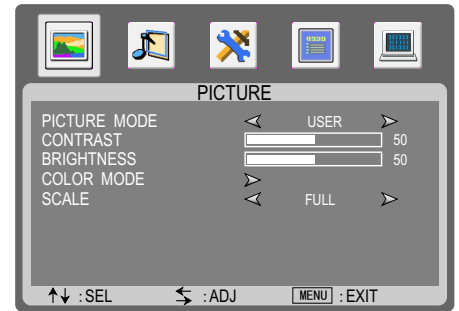

Option	Function	Choice/Remarks
Picture Mode	Selects picture mode.	Outside/User/Standard/Night Note: you may directly press PICTURE button on the remote control to select.
Contrast	Adjusts image contrast.	▶ : stronger ◀ : weaker
Brightness	Adjusts screen brightness for easier viewing of dark picture such as night scenes and black hair.	▶ : lighter ◀ : darker
Color Mode (Color Temperature)	Selects one of three automatic color adjustments. Set to warm to enhance hotter colors such as red, or set to cool to see less intense colors with more blue, or you may customize the color mode by yourself.	Normal/Warm/Cool/User
Scale	Select screen aspect ratio	Normal/Full Note: you may directly press SCALE button on the remote control to select.

Customizing the Color Mode(Color Temperature)

- 1 Navigate to **PICTURE** menu, highlight **COLOR MODE** item, press **◀** or **▶** to access.
- 2 Press **◀** or **▶** to select **USER**.
- 3 Press **▲** or **▼** to select **USER-R**, **USER-G** or **USER-B**.
- 4 Press **◀** or **▶** to adjust.

Note: The color temperature options are adjusted only when you set the **COLOR TEMP.** to **User**.

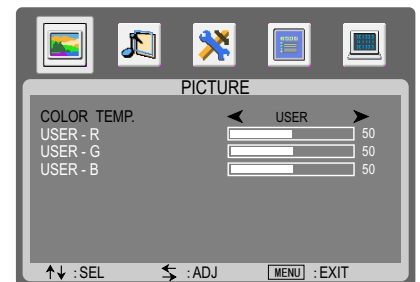

(Only in VGA mode)

Adjusting Image Geometry

- 1 Press **MENU** to display the menu main page.
- 2 Press **◀** or **▶** repeatedly to select **GEOMETRY** menu, and press **▼** to access.
- 3 Within the menu, use **▲** , **▼** , **◀** or **▶** to navigate or adjust.

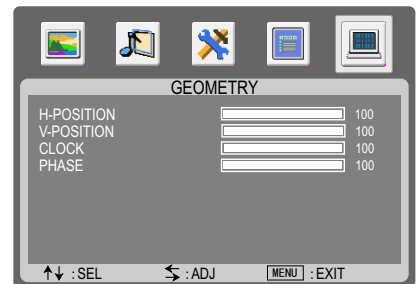

Option	Function	Choice/Remarks
H-Position	Adjust the horizontal position of the image.	▶ : rightward ◀ : leftward
V-Position	Adjust the vertical position of the image.	▶ : downward ◀ : upward
Clock	Adjusts the sample frequency.	
Phase	Improves the focus of stable image.	

Note: You can press the **ADJUST** button on the remote control to rectify the picture automatically.(Only in VGA mode)

Troubleshooting

Before calling for repair service, check the following items for possible remedies to an encountered symptom.

Symptoms	Check item
No power	<ul style="list-style-type: none"> • Check that the AC power cord is plugged into the mains socket. • Unplug the power cord, wait for 60 seconds. Then re-insert plug into the mains socket and turn on the unit again.
No picture	<ul style="list-style-type: none"> • Check video connections at the rear of the unit to see if it is properly connected to the unit. • Adjust the contrast and brightness settings. • Select a correct input. • Is a non-compatible signal being input?
Good picture but no sound	<ul style="list-style-type: none"> • Increase the VOLUME. • Check that the unit is not muted.
Good sound but poor color	<ul style="list-style-type: none"> • Adjust the contrast, color and brightness settings.
Poor picture	<ul style="list-style-type: none"> • Sometimes, poor picture quality occurs when an activated S-VHS camera or camcorder is connected while another activated peripheral is connected. In this case, switch off one of the peripherals. • Check whether the room is too bright.
Horizontal dotted line	<ul style="list-style-type: none"> • This may be caused by electrical interference (e.g. hairdryer, nearby neon lights, etc.). • Turn off the equipment.
Remote operation fails.	<ul style="list-style-type: none"> • Check whether the batteries are working. Replace if necessary. • Clean the remote control sensor lens on the unit. • Do not use the remote control under strong or fluorescent lighting. • The batteries should be inserted with polarity (+, -) aligned.
Snowy picture and noise	<ul style="list-style-type: none"> • Check the A/V connections.
No stable or not synchronized VGA picture	<ul style="list-style-type: none"> • Check if you have selected the correct VGA mode in your PC.
No output from one of the speakers	<ul style="list-style-type: none"> • Adjust Balance in the SOUND menu.
Control buttons do not work.	<ul style="list-style-type: none"> • Unplug the power cord, wait for a few seconds. Then re-plug the power cord and turn on the unit again.

Do not use in hot and cold rooms (locations)

- When the unit is used in rooms (locations) with low temperature, the picture may leave trails or appear slightly delayed. This is not a malfunction, and the unit will recover when the temperature returns to normal.
- Do not leave the unit in a hot or cold location. Also, do not leave the unit in a location exposed to direct sunlight or near a heater, as this may cause the cabinet to deform and the LCD panel to malfunction.

(Storage temperature: 0°C to +50°C Working temperature: 5°C to +40°C)

Note:

*If your problem is not solved, turn your unit off and then on again.
Never attempt to repair a defective TV yourself.*

Care and Maintenance

LCD Display panel information

Important Information Regarding Use of Video Games, Computers, Captions or Other Fixed Image Displays.

The extended use of fixed image program material can cause a permanent "shadow image" on the LCD panel.

This background image is viewable on normal programs in the form of a stationary fixed image. This type of irreversible LCD panel deterioration can be limited by observing the following steps:

- A. Reduce the brightness/contrast setting to a minimum viewing level.
- B. Do not display the fixed image for extended periods of time.
- C. Turn the power off when not in actual use.

Note:

The marking or retained image on the LCD panel resulting from fixed image use is not an operating defect and as such is not covered by Warranty. This product is not designed to display fixed image patterns for extended periods of time.

Cleaning and Maintenance

To clean this unit, wipe with a soft, dry cloth.

If the surfaces are extremely dirty, use a soft cloth dipped in a soap and water solution or a weak detergent solution.

- Use eyeglass cleaner to remove stubborn dirt from the LCD.
- Never use alcohol, paint thinner or benzine to clean this unit.
- Before using a chemically treated cloth, read the instructions that came with the cloth carefully.

Specifications

Screen:	26"	32"	
Power supply:	AC 100-240V,50/60Hz	AC 100-240V,50/60Hz	
Power consumption:	100W	150W	
Unit Dimensions (WxHxD)(inch)	28.1X23.9X9.3	33.0X27.3X10.2	
Weight:	41.8(lbs)	50.6(lbs)	
TV system & Channel coverage:			
System	VHF	UHF	CATV
NTSC-M	2-13	14-69	1-125
TV system:	NTSC-M		



- 1. Design and specifications are subject to change without notice.**
- 2. Weight and dimensions shown are approximate.**
- 3. Specifications and external appearance may be changed for the sake of improvement.**

SANYO COMFORT WARRANTY

WARRANTY APPLICATION

New, unused SANYO Color Television products purchased in Canada through a SANYO authorized dealer are warranted against manufacturing defects in materials and workmanship for ONE YEAR for parts and labor, from the date of purchase by the original retail purchaser for non-commercial use. This warranty only applies in favor of the original retail purchaser of the warranted product.

SANYO CANADA INC.'S RESPONSIBILITY

During the warranty period, SANYO Canada Inc. will repair, or at our option, replace a Color Television product which shows evidence of a manufacturing defect in materials or workmanship.

Replacement PARTS are warranted for the remaining portion of the warranty period.

WHAT IS NOT COVERED

- (a) Color Television products purchased outside Canada.
- (b) Color Television products purchased in a used condition.
- (c) Problems due to product set-up and installation.
- (d) Adjustments that are outlined in the Operating Manual.
- (e) Accessory items including antenna, batteries and connecting cables.
- (f) Damage in or due to transportation.
- (g) Damage due to improper maintenance, accident, abuse, misuse or negligence.
- (h) Damage caused by lightning and power surges.

ORIGINAL RETAIL PURCHASER'S RESPONSIBILITY

You, the original retail purchaser, must present your original, dated bill-of-sale together with this warranty to SANYO Canada Inc. or to an authorized Sanyo Service Depot* when you make a claim under this warranty.

You, the original retail purchaser, are responsible for any costs of TRANSPORTING the product to and from SANYO Canada Inc. or an authorized SANYO Service Depot. You also are responsible for the cost of any MAINTENANCE necessary in respect of the product.

*In-home service is only available to the units whose screen size is 40 inches or over, and limited to the locations within a 30-km radius of any authorized SANYO Service Depot, throughout Canada.

WARRANTY BECOMES VOID This warranty becomes void if the product's serial numbers are altered or removed or if any repair to the product is made other than by SANYO Canada Inc. or by an authorized Sanyo Service Depot.

LIMITATIONS

- (a) SANYO Canada Inc. reserves the right to change or improve the design of the model of the product warranted hereunder without incurring any obligation to make any modifications to or to install any improvement in or on the product.
- (b) In no event shall SANYO Canada Inc. or any of its Authorized Dealers be liable for special or consequential damage arising from the use of this product.

STATUTORY WARRANTIES

The above provisions do not preclude the operation of any applicable provincial statute which in certain circumstances may not allow some of the limitations and exclusions described in this Warranty. Where any terms of this Warranty are prohibited by such a statute, they shall be deemed null and void but the remainder of this warranty shall remain in effect.

HOW TO OBTAIN WARRANTY SERVICE

Please contact the SANYO Authorized Dealer from whom the product was purchased or contact us directly at:

SANYO Canada Inc.
300 Applewood Cres.
Concord Ont. L4K 5C7
(905) 760-9944
1-800-263-2244

Free Manuals Download Website

<http://myh66.com>

<http://usermanuals.us>

<http://www.somanuals.com>

<http://www.4manuals.cc>

<http://www.manual-lib.com>

<http://www.404manual.com>

<http://www.luxmanual.com>

<http://aubethermostatmanual.com>

Golf course search by state

<http://golfingnear.com>

Email search by domain

<http://emailbydomain.com>

Auto manuals search

<http://auto.somanuals.com>

TV manuals search

<http://tv.somanuals.com>