



Model No.:
No. de Modelo: DS24425
Nº de modèle :

Color TV Owner’s Manual
Color TV Manual Del Proprietario
Manuel d’instructions du télécouleur

“Read this manual before assembling
(or using) this product.”

CONTENTS

Important Safety Instructions 2	TV Adjustment and Setup	Warranty (Mexico) 16
Welcome to the World of Sanyo 3	How to Operate the	Warranty (U.S.A. and Canada) 17
Features 3	On-Screen Menu 10	Child Safety Matters Back Cover
Specifications 3	Audio Mode 11	
Basic Set-up and Connections 4	Adjusting Picture/Sound 11	ESPAÑOL 18 ~ 35
Front & Rear Panel 5	Adding or Deleting a Channel 11	Contenido 18
Using the Component Video	Aspect Ratio 12	
and Audio Input Jacks 6	Closed-Captioning 12	FRANÇAIS 36 ~ 51
Using the Front A/V Input Jacks 7	V-Guide (Parental Control) . . . 13 ~ 14	Table des matières 36
Using the Rear A/ V Input Jacks 8	Care and Cleaning 14	
Using the Remote Control 9 ~ 10	Helpful Hints (problems/solutions) . 15	

Importado Por :
Comercializadora México
Americana, S. DE R.L. DE C.V.
Nextengo Nº 78
Col. Santa Cruz Acayucan
Del. Azcapotzalco, México D.F. C.P.
02770, RFC CMA 9109119L0
Telefono: 55-5328-3500

Printed in U.S.A. SMC, March 2005
Impreso en U.S.A. SMC, Marzo 2005
Imprimé aux É.-U. SMC, mars 2005
Part No. / No. de Parte/
Nº de pièce : **1JC6P1P0173A-**
Service Code/Código de Servicio/
Code de service : 610 312 9181

CAUTION

RISK OF ELECTRIC SHOCK DO NOT OPEN

THIS SYMBOL INDICATES THAT DANGEROUS VOLTAGE CONSTITUTING A RISK OF ELECTRIC SHOCK IS PRESENT WITHIN THIS UNIT.



CAUTION: TO REDUCE THE RISK OF ELECTRIC SHOCK, DO NOT REMOVE COVER (OR BACK). NO USER-SERVICEABLE PARTS INSIDE. REFER SERVICING TO QUALIFIED SERVICE PERSONNEL.

THIS SYMBOL INDICATES THAT THERE ARE IMPORTANT OPERATING AND MAINTENANCE INSTRUCTIONS IN THE LITERATURE ACCOMPANYING THIS UNIT.



WARNING: TO REDUCE THE RISK OF FIRE OR ELECTRIC SHOCK, DO NOT EXPOSE THIS APPLIANCE TO RAIN OR MOISTURE.

IMPORTANT SAFETY INSTRUCTIONS

CAUTION: PLEASE ADHERE TO ALL WARNINGS ON THE PRODUCT AND IN THE OPERATING INSTRUCTIONS. BEFORE OPERATING THE PRODUCT, PLEASE READ ALL OF THE SAFETY AND OPERATING INSTRUCTIONS. RETAIN THIS LITERATURE FOR REFERENCE. Follow all instructions...

Positioning the appliance

1. Do not place your appliance on an unstable cart, stand, shelf or table. Serious injury to an individual, and damage to the appliance, may result if it should fall. Your salesperson can recommend approved carts and stands or shelf and wall mounting instructions. An appliance and cart combination should be moved with care. Quick stops, excessive force, and uneven surfaces may cause the appliance and cart combination to overturn. 
2. Slots and openings in the cabinet and in the back or bottom are provided for ventilation. To ensure reliable operation of the appliance and to protect it from overheating, these openings must not be blocked or covered. The openings should never be covered with a cloth or other material, and the bottom openings should not be blocked by placing the unit on a bed, sofa, rug, or other similar surface. This appliance should never be placed near or over a radiator or heat register. This appliance should not be placed in a built-in installation such as a bookcase unless proper ventilation is provided.
3. Do not expose the appliance to rain or use near water . . . for example, near a bathtub, swimming pool, kitchen sink, in a wet basement, etc.

Hooking Up Outdoor Antenna

LIGHTNING PROTECTION FOR YOUR ANTENNA AND SET AS PER NATIONAL ELECTRICAL CODE INSTRUCTIONS.

EXAMPLE OF ANTENNA GROUNDING ACCORDING TO NATIONAL ELECTRICAL CODE, ANSI/NFPA 70

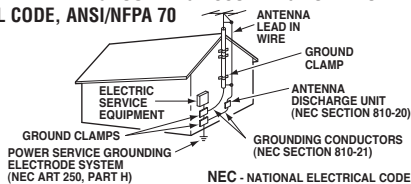

"Note to CATV system installer:

This reminder is provided to call the CATV system installer's attention to Article 820-40 of the NEC that provides guidelines for proper grounding and, in particular, specifies that the cable ground shall be connected to the grounding system of the building, as close to the point of cable entry as practical."

4. If an outside antenna is connected to the receiver, be sure the antenna system is grounded so as to provide some protection against voltage surges and built up static charges. Article 810 of the National Electrical Code, ANSI/NFPA 70, provides information with respect to proper grounding of the mast and supporting structure, grounding of the lead in wire to an antenna discharge unit, size of grounding conductors, location of antenna discharge unit, connection to grounding electrodes, and requirements for the grounding electrode.

An outside antenna system should not be located in the vicinity of overhead power lines or other electric light or power circuits, or where it can fall into such power lines or circuits. When installing an outside antenna system extreme care should be taken to keep from touching such power lines or circuits as contact with them might be fatal.

Plug in the power cord

5. This product should be operated only from the type of power source indicated on the marking label. If you are not sure of the type of power supply to your home, consult your product dealer or local power company. This product is equipped with a polarized alternating current line plug (a plug having one blade wider than the other). This plug will fit into the power outlet only one way. This is a safety feature. If you are unable to insert the plug fully into the outlet, try reversing the plug. If the plug should still fail to fit, contact your electrician to replace your obsolete outlet. Do not defeat the safety purpose of this polarized plug. Do not overload wall outlets, extension cords, or integral convenience receptacles as this can result in a risk of fire or electric shock.
6. Power-supply cords should be routed so that they are not likely to be walked on or pinched by items placed upon or against them, paying particular attention to cords at plugs, convenience receptacles, and the point where they exit from the product.

Cleaning

7. Before cleaning, unplug the unit from the wall outlet. Do not apply liquid cleaners or aerosol cleaners directly to the unit. Use a dry cloth for cleaning.

Service & Repair

8. Unplug the appliance from the wall outlet and refer servicing to qualified service personnel under the following conditions:
 - A. If the power cord or plug is damaged or frayed.
 - B. If liquid has been spilled into the appliance.
 - C. If the appliance has been exposed to rain or water.
 - D. If the appliance has been dropped or the cabinet has been damaged.
 - E. If the appliance exhibits a distinct change in performance.
 - F. If the appliance does not operate normally by following the operating instructions, adjust only those controls that are covered in the operating instructions. Improper adjustment of other controls may result in damage and will often require extensive work by a qualified technician to restore the appliance to normal operation.
9. Upon completion of any service or repair, request the service technician's assurance that only Factory Authorized Replacement Parts that have the same characteristics as the original parts were used, and that routine safety checks have been performed to determine that the appliance is in safe operating condition. Unauthorized substitutions may result in fire, electrical shock, or other hazards.
10. Never add accessories that have not been specifically designed for use with this appliance as they may cause hazards.
11. For added protection during a lightning storm, or when the set is left unattended and unused for long periods of time, unplug it from the wall outlet and disconnect the antenna. This will prevent damage to the set due to lightning or power line surges.
12. Never push objects of any kind into this product through openings as they may touch dangerous voltage points or short-out parts that could result in a fire or electric shock. Never spill liquid of any kind on the product.

2 **Need help?** Visit our Web site at www.sanyoctv.com or Call **1-800-877-5032**

Welcome to the World of Sanyo

Thank you for purchasing a Sanyo Color Television. You made an excellent choice for Performance, Styling, Reliability, and Value. The TV is designed with easy to use on-screen set-up instructions and operating features. Please retain this owner's manual for future reference. **Need assistance? Visit our Web site at www.sanyoctv.com or call toll free 1-800-877-5032. We can help!**

FEATURES

- ◆ Trilingual On-Screen Menu
 - ◆ Automatic Channel Search
 - ◆ Auto Shut Off
 - ◆ Closed-Captioning/Quikcap
 - ◆ Digital picture controls with on-screen display
 - ◆ MTS stereo/SAP Decoder
 - ◆ Auto Flesh Tone
 - ◆ Factory preset adjustments for picture/sound
 - ◆ Front Surround Sound
 - ◆ Tone
 - ◆ V-Guide (Parental Control)
- ◆ Game Mode
 - ◆ Aspect Ratio setting
 - ◆ 480i Component AV Input Jacks
 - ◆ Audio/Video In Jacks
2 sets—Front (AV1), Rear (AV2)
 - ◆ S-Video In Jack
 - ◆ Sleep Timer (3 hours)
 - ◆ TV Reset
 - ◆ **181 Channel Tuning System**
VHF Channels 2-13
UHF Channels 14-69
Cable TV (CATV) 1, 14-125
- ◆ **Automatic Fine Tuning**
VHF and Cable Channels
 - ◆ **24-Key Remote Control**
0~9 Numbered Channel Selection
Channel Scanning
Volume Mute
Power Recall
Display Sleep
Caption Reset
Menu V-Guide
Input

SPECIFICATIONS

PICTURE TUBE SIZE, True Flat Screen (Measured Diagonally)	24-inches
PICTURE RESOLUTION	260 Lines
Video Input	400 Lines
ANTENNA INPUT	UHF/VHF/CATV 75Ω
POWER REQUIREMENT	120VAC 60Hz
POWER	78 watts
HORIZONTAL DIM. (Width)	26.6 in. (677mm)
VERTICAL DIM. (Height)	20.6 in. (524mm)

DEPTH DIM. (Thickness)	18.9 in. (480mm)
WEIGHT (Approx.)	60.1 lbs. (27.3 Kg.)
SOUND (2 Speakers)	Size: 5x9 cm
AMPLIFIER	Built-in with 1W/ch
AUDIO/VIDEO INPUT JACKS	Video Input Audio Input (2 sets, R/L – Front/Rear) S-Video Input

480i COMPONENT VIDEO

INPUT JACKS Component Video Inputs (Y, Pb, Pr – R/L)

CAUTION: FCC Regulations state that improper modifications or unauthorized changes to this unit may void the user's authority to operate the unit.



This symbol on the nameplate means the product is Listed by Underwriters' Laboratories Inc. It is designed and manufactured to meet rigid U.L. safety standards against risk of fire, casualty and electrical hazards.

Need help? Visit our Web site at www.sanyoctv.com or Call 1-800-877-5032

BASIC SET-UP AND CONNECTIONS

INITIAL SET-UP

1. Install batteries in remote control, see page 9.
2. Connect signal, see below.
3. Plug in AC power cord.
4. Press **POWER** key to turn on TV.
5. Follow on-screen instructions, see pages 10 ~ 12.

CONNECTING CABLE SERVICE, OR RF ANTENNA, OR SATELLITE DISH RECEIVER TO TV

- ① Cable Box OR ① Satellite Receiver OR ① RF Antenna

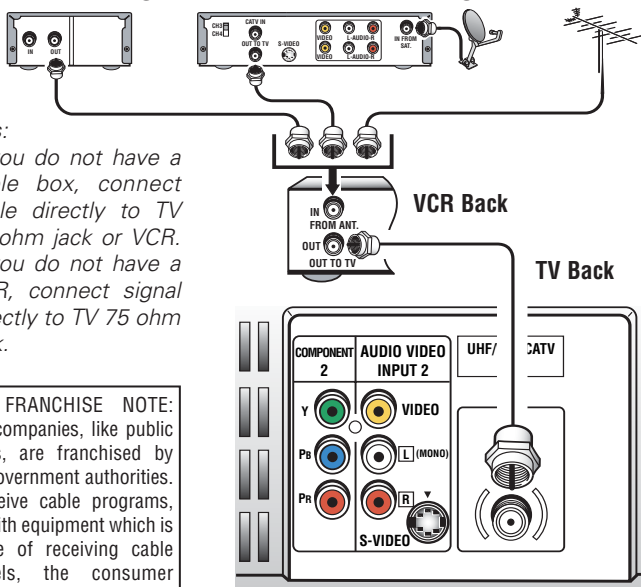

Notes:

- If you do not have a cable box, connect cable directly to TV 75 ohm jack or VCR.
- If you do not have a VCR, connect signal directly to TV 75 ohm jack.

CATV FRANCHISE NOTE: Cable companies, like public utilities, are franchised by local government authorities. To receive cable programs, even with equipment which is capable of receiving cable channels, the consumer must subscribe to the cable company's service.

Operational Tip for No Signal Connection:

If the TV is used as a monitor only, with a DVD player or some other type of external equipment, and no cable or antenna signal is available, the following setup is necessary:

- Your TV is designed to automatically search for available channels. Therefore, the initial start up requires that you press the **MENU** key, enabling the TV to automatically go through the channel search process before you can operate the TV. After the initial channel search is completed, you must press the **MENU** key again to complete the channel search process. This may take several minutes.
- After the channel search process is complete (2 searches), you can press the **INPUT** key on the remote control to use the TV as a monitor.

Quick Tips

- The TV will automatically select the correct Antenna mode for the type of RF signal you connect.
- TV will switch off automatically after 15 minutes if there is no signal reception (cable out or station not broadcasting).
- **Exception**—When the Video mode is selected, the TV will not automatically switch off when signal reception has stopped for 15 minutes.
- If you move the TV to a new location, press the **RESET** key twice after connecting the signal and turning on the TV.

FRONT AND REAR PANELS

FRONT

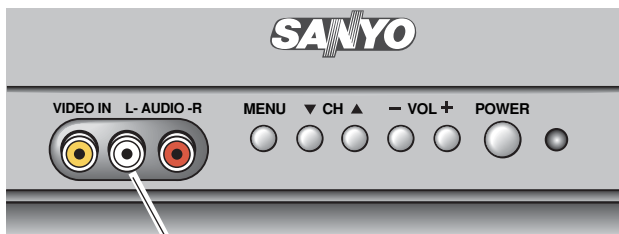

Audio Video Input Jacks (AV1)

Connect video equipment here (see page 7).

BACK

480i Component Video In Jacks (Component 2: Y, Pb, Pr)

Connect video equipment here
(see page 6).

*Note: Audio Video Input 2 (AV2) and
Component inputs share the same
audio (R/L) input jacks.*

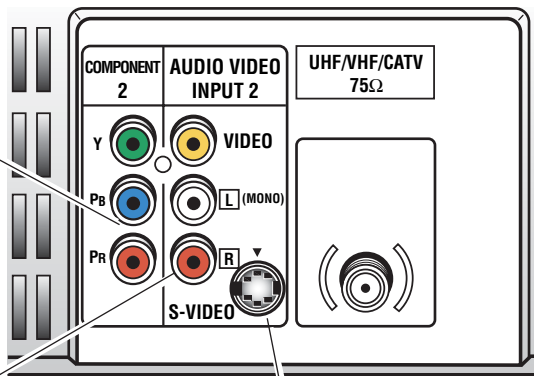

Audio Video Input 2 Jacks (AV2)

Connect video equipment here (see pages 6 and 8).

*Note: S-Video connection will override an AV2
video connection.*

S-Video In Terminal

To enhance video detail use the AV2
S-Video jack instead of the AV2 Video jack,
if available on your external equipment. (An
S-Video connection will override connection to
the AV2 video input jack. See page 8.)

POSITIONING THE TV

Do not position the TV in a confined
area. Allow space for normal air
circulation around electronic parts.

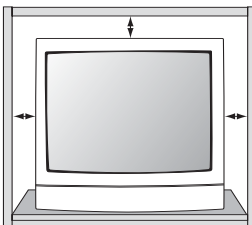

Need help? Visit our Web site at www.sanyoctv.com or Call 1-800-877-5032

USING THE COMPONENT VIDEO AND AUDIO INPUT JACKS

CONNECTING A DVD PLAYER

Switch off TV and external equipment before connecting cables. (Cables are not supplied.)

- 1 Connect a DVD Player or other equipment's interlaced Component Video Out to the TV Component Video In (Y-Pb-Pr) Jacks.
- 2 Connect the DVD Player's Audio Out to the TV AV2 Audio In (L/R) Jacks.
- 3 Press **POWER** to turn on the TV. Turn on external equipment also.
- 4 To access Audio Video inputs, press the **INPUT** key to select COMPONENT2.

Notes: DVD Player component output **must** be set to Interlaced (480i).

Audio Video Input 2 (AV2) and Component inputs share the same audio (R/L) input jacks.

Connect equipment to the Component2 video input or the AV2 video input, but not both types at the same time.

What you will need for connections:

- 1 Component video cable – 1
- 2 Audio Cable – 1

Remote Control

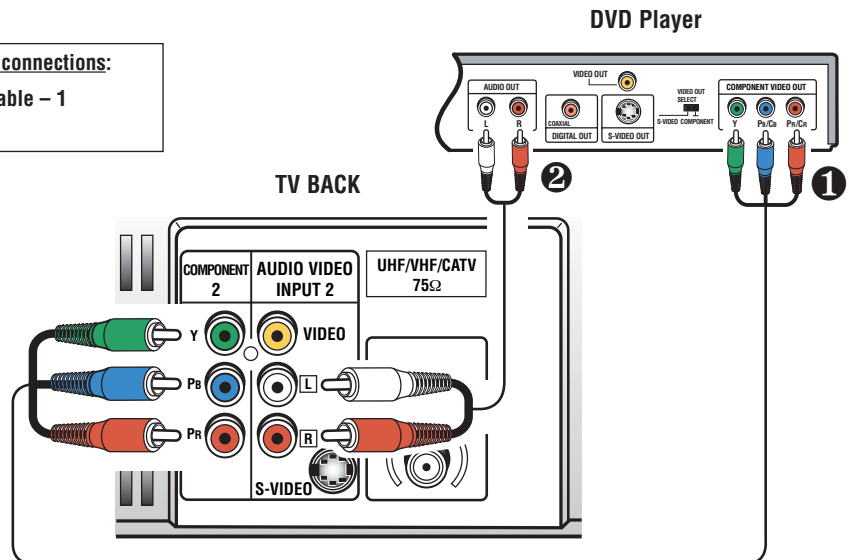
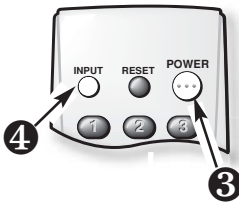

Quick Tips

■ A solid Blue screen with COMPONENT2 displayed means that the Video mode is selected, but no signal is being detected at the Component jacks. Check connection, and turn on external equipment.

■ Press **INPUT** key after connecting cables to access the AV inputs. There is NO need to tune to a blank channel.

6 **Need help?** Visit our Web site at www.sanyoctv.com or Call 1-800-877-5032

USING THE FRONT VIDEO AND AUDIO INPUT JACKS

CONNECTING A VIDEO GAME OR OTHER EQUIPMENT

Switch off TV and external equipment before connecting cables. *(Cables are not supplied.)*

❶ Connect game Audio Output (R/L) to the TV Audio Input (R/L). Then connect game Video Output to the TV Video Input.

❷ Press **POWER** to turn on the TV. Turn on external equipment also.

❸ To access Audio Video inputs, press the **INPUT** key to select GAME or select using the menu.

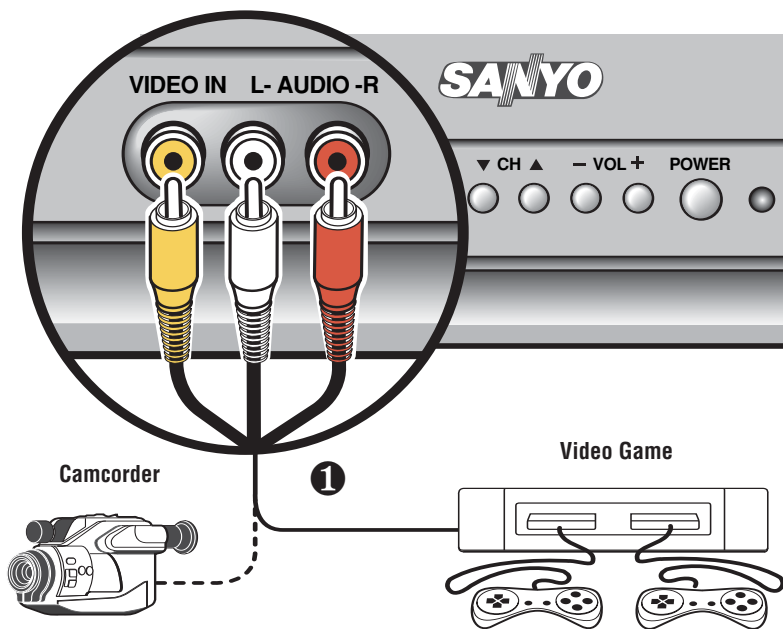

What you will need for connections:

❶ Audio Cable - 1

Remote Control

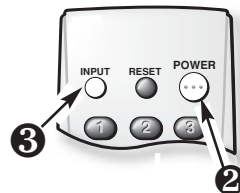

Quick Tips

■ A solid Blue screen with the word *VIDEO1* displayed, means that the Video mode is selected, but no signal is being detected at the Video jacks. Check connections, turn on external equipment.

■ Press **INPUT** key after connecting cables to access the AV inputs. There is **NO** need to tune to a blank channel.

USING THE REAR AUDIO / VIDEO INPUT JACKS

CONNECTING A VCR OR OTHER EQUIPMENT

Switch off TV and external equipment before connecting cables. (*Cables are not supplied.*)

- 1 Connect VCR or other equipment's Audio Video Out to the TV Audio Video Input.

For Mono VCR (Single Audio Jack) connect VCR Audio Out to TV Audio (L) Input.

- 1 OR

Connect DVD Player or other equipment's S-Video Out and Audio Out to the TV S-Video and Audio In Jacks.

Using the S-Video jack overrides the Video (AV2) jack.

- 2 Press **POWER** to turn on the TV. Turn on external equipment also.
- 3 To access Audio Video inputs, press the **INPUT** key to select VIDEO2.

Note: Audio Video Input (AV2) and Component inputs share the same audio (R/L) input jacks.

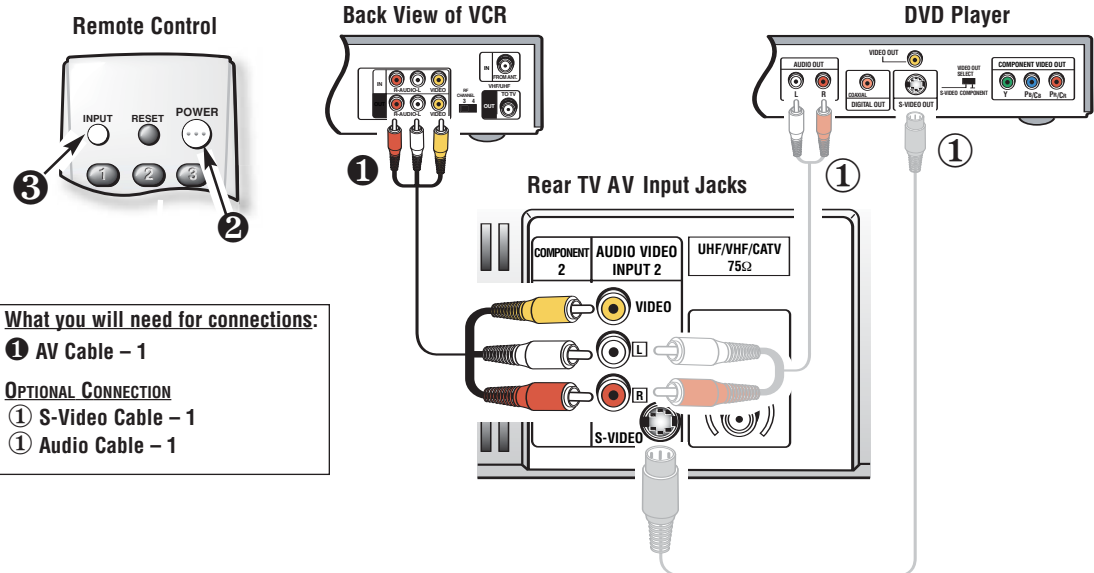

Quick Tips

- Make sure all cable connectors are fully seated on jacks.
- Always match AV cables according to the colors; red for right audio, white for left audio and yellow for video.
- Press **INPUT** key after connecting cables to access the A/V inputs. There is NO need to tune to a blank channel.
- A solid Blue screen with the word VIDEO2 displayed, means that the Video mode is selected, but no signal is being detected at the Video jacks. Check connections, turn on external equipment.

USING THE REMOTE CONTROL

INSTALL BATTERIES AS SHOWN (2 AAA, not included)

Notes:

- Do not mix old batteries with new ones or mix different types of batteries together.
- Remove the batteries if the remote control will not be used for a month or more. Weak batteries may leak and cause damage. (Normal battery life is roughly six months.)

IMPORTANT NOTE: Spent or discharged batteries must be recycled or disposed properly in compliance with all applicable laws. For detailed information, contact your local County Solid Waste Authority.

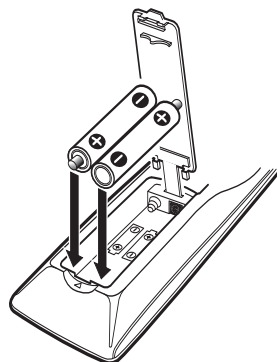

REMOTE CONTROL KEYS

- ① **Power Key**—Press to turn TV ON or OFF.
- ② **Input Key**—Press to select the program source to watch: TV signal or signal from DVD Player or other equipment you have connected to the A/V jacks.
- ③ **Number Keys**—Press two keys to select a channel. *Example:* Press **0** then **6** to select channel 6. For cable channels 100 through 125, press and hold the **1** key until C1— appears. Then press the other two numbers.
- ④ **Caption Key**—(See page 12.)
- ⑤ **Menu Key**—Use this key with the ▲▼ and – + keys to navigate and adjust features of the on-screen menu system. (See pages 10 ~ 12.)
- ⑥ **Channel Scanning (CH ▲▼) and Volume (VOL – +) Keys**—Press to scan through the channels in memory and to adjust the volume.

Quick Tips

- Be sure batteries are installed correctly.
- Point the remote control toward the TV. Objects between the remote control may cause misoperation of the remote control function.
- Cannot select channel with number keys. Press “0” in front of numbers 1~9. *Example:* Channel 05.
- Adjusting the volume level: Flashing Right arrow indicates volume is increasing and flashing Left arrow indicates volume is decreasing.

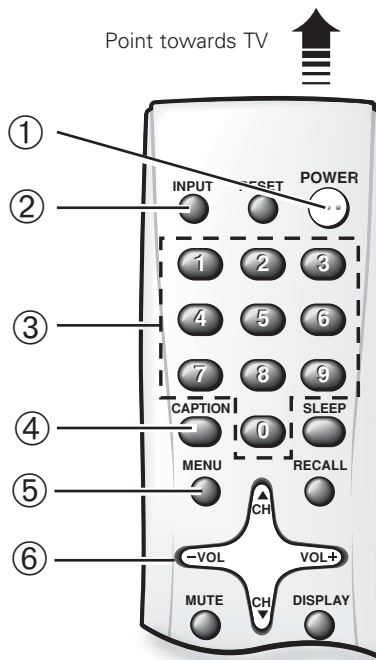

(Continued on page 10.)

Need help? Visit our Web site at www.sanyoctv.com or Call 1-800-877-5032

REMOTE CONTROL KEYS (CONTINUED)

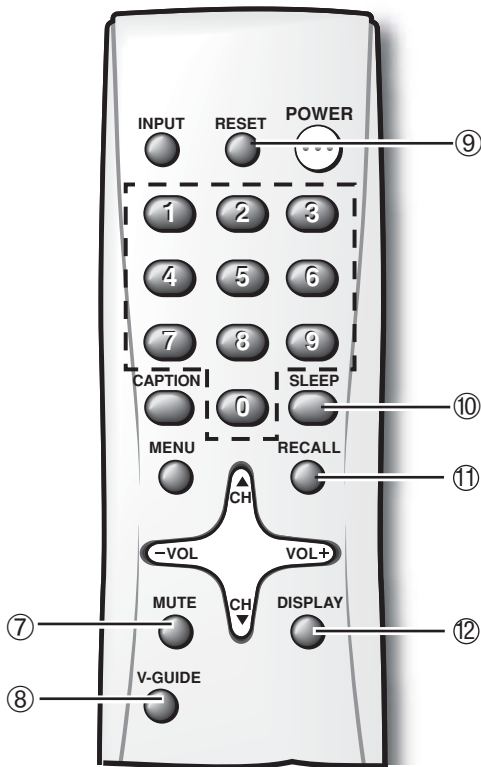

- ⑦ **Mute Key**—Press once to minimize the volume. Press again to restore.
- ⑧ **V-Guide Key**—See pages 13 ~ 14.
- ⑨ **Reset Key**—Press this key **twice** to restore factory settings. The TV will automatically start Channel Search and clear all customized settings. These features will automatically reset:
- Picture Adjustments: Color, Tint, Contrast, Bright, Sharpness, Tone, and Surround
 - Audio to Stereo
 - Aspect Ratio to 4:3 (normal)
 - Channel Memory
 - Caption to OFF
 - V-Guide to OFF
 - Language to English
 - Sleep Timer
 - Video to TV
- If desired, personal settings can be made again using the menu options.
- ⑩ **Sleep Key**—Press this key then press the “0” key to set the Sleep Timer. The desired time can be set from 30 minutes up to 3 hours in 30-minute increments. Sleep Timer will switch off the TV automatically.
- Note: The Sleep Timer cancels when the TV is turned off or if a power failure occurs.*
- ⑪ **Recall Key**—Press to switch between the last two channels you selected.
- ⑫ **Display Key**—Press once to display the channel number. Press twice to display the channel number continuously. Press again to remove the channel number.

TV ADJUSTMENT AND SETUP

The on-screen menu provides the viewer with easy access to adjustments and settings. Just use the keys on the remote control and follow the on-screen instructions.

HOW TO OPERATE THE ON-SCREEN MENU

1. Press **MENU** key.
2. Use the ▲▼ keys to highlight the desired feature.
3. Use the – + keys to choose desired option. (▶ indicates selected item.)
4. Press the **MENU** key to exit.

Items with submenus require additional steps.

Note: The menu will display on the screen for approximately 20 seconds. Press Menu again to redisplay.

▲▼ keys	– + keys	
Audio	▶Stereo	Mono
SAP		
Picture /Sound	▶Auto Game	Manual
Antenna	▶Cable	VHF/UHF
CH. Search	▶NO	Start
CH. Scan Memory	C 34	Added
Aspect Ratio	▶4:3	16:9
Menu Language	▶English	Espanol Francais
Press MENU key to exit		

10 **Need help?** Visit our Web site at www.sanyoctv.com or Call 1-800-877-5032

SETTING AUDIO MODE

Select desired sound setting, Stereo, Mono, or SAP (secondary audio program).

Note: Stereo and SAP must be part of the broadcast signal.

1. Choose Stereo, Mono, or SAP from the Audio options.

Note: The TV will automatically reset to stereo if unplugged or a power failure occurs.



ADJUSTING PICTURE/SOUND

For automatic picture/sound adjustment

Choose Auto from the Picture/Sound options.

Adjust the picture/sound manually

1. Choose Manual from the Picture/Sound options.
2. Press the **MENU** key to open the picture/sound settings submenu.
3. Use the ▲▼ keys to highlight the picture or sound setting you want to change.
4. Use the - + keys to adjust settings.

For automatic game settings

1. Choose Game from the Picture/Sound options. The screen and sound will automatically change to factory preset settings.
2. Press the **MENU** key to exit.

*Note: Select the front A/V input jacks by pressing the **INPUT** key on the remote control.*

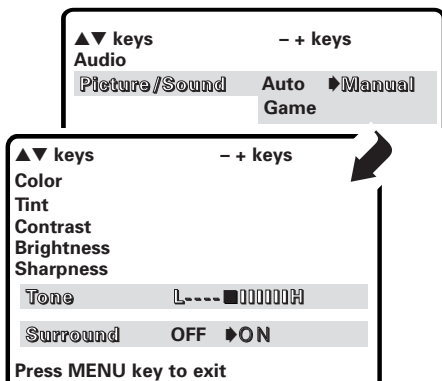

RESETTING THE ANTENNA/CABLE MODE AND CHANNEL SEARCH

Resetting the Antenna/Cable Mode or CH. (Channel) Search is required *only* if additional channels become available, such as moving to another city or having a cable service installed.

1. Choose Start from the Ch. Search menu options.

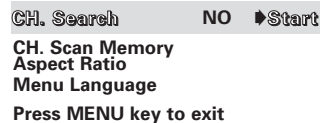

ADDING OR DELETING CHANNELS

1. Press the **MENU** key.
2. Use the ▲▼ keys to highlight CH. Scan Memory.
3. Press the + key to highlight channel number entry area.
4. Enter the channel number you want to add or delete (example): C34. For cable channels above 99, press and hold the **1** key until C1-- appears. Then enter the other two numbers.
5. Press the + key to change the present setting. *Example:* Added will change to Deleted. This takes about three seconds. During that time, the word "Added" or "Deleted" will become yellow.
6. Use the 0 ~ 9 or ▲▼ keys to choose other channels to delete or add, or press the **MENU** key to exit.

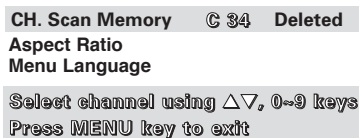

Quick Tips

- The menu will display on the screen for approximately 20 seconds. Press **MENU** again to redisplay.
- Under weak stereo signal conditions, you may receive better quality sound in the "Mono" position.
- Surround sound will expand the sound effect while receiving MTS stereo signals.
- When setting the Antenna mode, choose Cable if your TV is connected to a cable system, otherwise choose VHF/UHF.
- Channels deleted from scan memory can be selected with the number keys.
- Restoring deleted channels, use the on-screen menu to manually add channels, or start CH. (Channel) Search from the menu, or press the **RESET** key twice. (It may take a few minutes to search thru the available channels.)

ASPECT RATIO

Use this feature when equipment is connected to the component input jacks. The 4:3 setting is for normal viewing. The 16:9 setting changes the picture image to widescreen viewing with minimal portion of top and bottom compressed.

1. Press the **MENU** key.

2. Use the **▲▼** keys to highlight Aspect Ratio.
3. Press the **- +** keys to select 4:3 or 16:9.

Aspect Ratio ▶4:3 16:9
Menu Language
Press MENU key to exit

CLOSED-CAPTIONING **CC**

Captioning is text information transmitted along with the picture and sound so it can be displayed on the TV screen. Because different types of captions can be transmitted with the TV signal, separate captioning modes are provided. The captioning modes recognized by this model are: Caption1, Caption2, Text1, and Text2. Local broadcasters decide which caption signals to transmit.

CAPTION1: Main mode used for program captioning (words match the program you are watching). These captions are generally one or two lines.



Caption1/2

CAPTION2: An alternative mode for program captioning. Caption2 may be used by the broadcaster to provide captions in another language, such as, Spanish or French.

TEXT1: This mode is used to display large amounts of text. This text will appear within a black box that may be nearly as large as the TV screen. Text displayed in this manner does not generally relate to the program. Captions may be used by broadcasters to provide weather reports, community bulletins, etc.

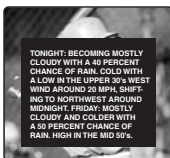

Text1/2

TEXT2: An alternative mode used to display large amounts of text (same as Text1).

QUIKCAP: Allows captions to toggle on and off with the Mute function. Press the **MUTE** key on the remote control to block the TV sound; the captions display automatically. Press the **MUTE** key again to restore the sound, the captions will disappear. Quikcap displays program captions in the Caption1 mode.

SETTING CAPTIONS

1. Press the **CAPTION** key on the remote control.
2. Press the **0** key on the remote control to select options: OFF, CAPTION1, CAPTION2, TEXT1, TEXT2, or QUIKCAP.

Quick Tips

- If Caption Text mode is selected and no captioned text is broadcasted, a black box may appear and remain on the TV screen as shown.

To remove this black box, set captioning to any mode other than Text1 or Text2 or press the **RESET** key to cancel captioning and other customized settings.



- Channel number will not display continuously when captioning is on.

V-GUIDE (PARENTAL CONTROL)

NOTE: THIS FEATURE IS DESIGNED TO COMPLY WITH THE UNITED STATES OF AMERICA'S FCC V-CHIP REGULATIONS. THEREFORE, IT MAY NOT FUNCTION WITH BROADCASTS THAT ORIGINATE IN OTHER COUNTRIES.

ABOUT MPAA AND TV PARENTAL GUIDELINES

MPAA and TV Parental Guidelines are rating systems that provide advance cautionary information to parents about the content of movie and television programming.

The V-Guide system contain both age-based and content-based settings. This gives parents discretionary ways of choosing appropriate material for their children to view.

Content ratings are represented by the initials D (Suggestive Dialog), L (Adult Language), S (Sexual Situations), V (Violence), and FV (Fantasy Violence). When program-

ming contains any or all of these conditions, these letters become part of the icon that is displayed on the TV screen.

A rating icon will generally appear in the upper left hand corner of the TV screen for about fifteen seconds at the beginning of a program and should be repeated at the beginning of the second hour of a long program. It may also appear when returning from commercials. There may be other instances when these icons will be displayed as well. Parents are encouraged to become familiar with these icons and their meanings.



V-GUIDE OPERATION

Use this feature to supervise television viewing for young children. This television can be set to automatically block programs with content you deem as inappropriate for your children to view, including: suggestive dialog, adult language, sexual situations, violence, and fantasy violence.

The ability of the television to block the reception of specific programming content depends upon several conditions: 1) The program must be rated, 2) Networks must broadcast the rating code data, 3) Cable companies must transmit the rating code signal, and 4) The TV must be properly setup to decode the signal.

SETTING MPAA MOVIE RATING

1. Press the **V-GUIDE** key on the remote control to display menu.
2. Press the **+** key to switch V-Guide ON.
3. Press the **+** key again. Then use the **▲ ▼** keys to highlight rating.
4. Press the **MENU** key to Block (B) or Unblock (U) selected rating.
(⇒ Arrow indicates selection.)
5. Press the **-** key to return to the V-Guide Options menu.

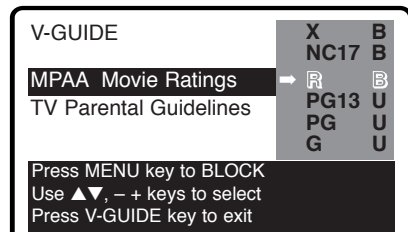

Quick Tips

- Use the **CHANNEL ▲ ▼** keys and the **VOLUME - +** keys to navigate through the menus.
- The V-Guide display remains on screen for approximately 20 seconds. If it disappears, press the **V-GUIDE** key.
- V-Guide feature is accessible only from the remote control.

(Continued on page 14.)

Need help? Visit our Web site at www.sanyoctv.com or Call 1-800-877-5032

13

SETTING TV PARENTAL GUIDELINES

- Use the ▲▼ keys to highlight TV Parental Guidelines.
- Press the + key. Then use the ▲▼ keys to highlight rating.
- Press the **MENU** key to Block (B) or Unblock (U) selected rating. (⇒ Arrow indicates selection.)

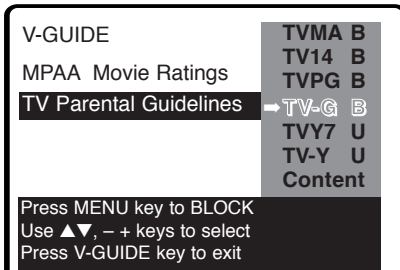

SETTING CONTENT-BASED GUIDELINES

- Follow steps 6 and 7. Use the ▲▼ keys to highlight Content.

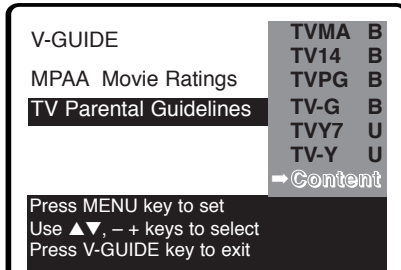

- Press the **MENU** key to display the Content Option menu.
- Use the ▲▼ keys to highlight a category (D-Suggestive Dialog, L-Adult Language, S-Sexual Situations, V-Violence, FV-Fantasy Violence).
- Press the + key. Then use the ▲▼ keys to highlight a rating.
- Press the **MENU** key to Block (B) or Unblock (U) selected rating. (⇒ Arrow indicates selection.)
- Press the **V-GUIDE** key to exit; or press the - key to return to the Content Options menu.
- Repeat steps 11 through 13 to Block (B) or Unblock (U) additional content ratings, if desired.

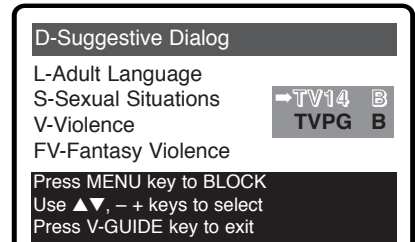

TURNING OFF THE V-GUIDE

- Press the **V-GUIDE** key.
- Use the -+ keys to select OFF.

Note: Networks and local stations may or may not include the content ratings portion of the TV Parental Guidelines.

Quick Tips

- The TV will automatically block (B) ratings above or unblock (U) ratings below selection. For example, if you block rating R, NC17 and X will be blocked as well.
- Blocking TVY7 does not block higher ratings.
- You can block a content rating such as TVPG-V and still be able to watch TVPG programs with ratings of S-L-D provided TVPG is unblocked (U).
- To temporarily unblock or view Blocked (B) programs, set V-GUIDE to OFF, or press the **RESET** key twice to clear all Blocked (B) ratings and other customized settings.

CARE AND CLEANING

The surface of the cabinet can be damaged if not properly maintained. Many common household aerosol sprays, cleaning agents, solvents, and polishes will cause permanent damage to the fine surface.

- Unplug the power cord before cleaning the television.**
- Clean the screen and cabinet with a soft dry cloth.

Note: Never spray liquids on the screen because it can run down and drip onto the chassis. This may cause component failure not covered under Warranty.



14 *Need help?* Visit our Web site at www.sanyoctv.com or Call 1-800-877-5032

HELPFUL HINTS (Problems/Solutions)

Because of the Quality we build into our product, very few problems are actual TV defects. Most problems only involve simple hookup or setup changes that can be solved by the customer. Please check the chart below and try the solutions listed for your problem. If the problem still persists, **before returning your TV**, please visit our website at www.sanyoctv.com or call us toll free at **1.800.877.5032**. *We can Help!*

Problem:	Check these Conditions:	Try these Solutions:	Page No.
TV turns off automatically.	<ul style="list-style-type: none"> • Check signal (Cable/Ant.) connection. • Power surge protection feature. 	<ul style="list-style-type: none"> • Press POWER key. • The sleep timer may have been set. • Unplug TV momentarily. 	4
No picture, poor picture, or wavy lines in picture.	<ul style="list-style-type: none"> • Check antenna connections. • May be station trouble. • Brightness or Contrast misadjusted. • Possible interference from household appliance. 	<ul style="list-style-type: none"> • Adjust antenna. • Try a different channel. • Select AUTO from Picture/Sound on-screen menu or press RESET key. • Turn off Mixer, Drill, Blender, etc. 	4, 11
No sound, poor sound. No sound on some channels.	<ul style="list-style-type: none"> • May be station trouble. • MUTE function may be on. • Check Audio/Video connections. 	<ul style="list-style-type: none"> • Try a different channel. • Adjust Volume. 	6~9
Black box on screen.	<ul style="list-style-type: none"> • Caption Text Mode without display information. 	<ul style="list-style-type: none"> • Press RESET key twice. • Switch OFF Captions (see page 12). 	12
No Cable channels above number 13.	<ul style="list-style-type: none"> • Cable Channel Indicator C should appear next to channel number. 	<ul style="list-style-type: none"> • Select CABLE from Antenna on-screen menu; then start CH. (channel) Search using the menu. 	11
No Captioning.	<ul style="list-style-type: none"> • Check if station is broadcasting a Closed-Caption signal. 	<ul style="list-style-type: none"> • Press CAPTION key to select Captioning. 	12
Poor color or no color.	<ul style="list-style-type: none"> • Check if program is in color. • Check antenna connections. • Color or Tint misadjusted. • May be station trouble. 	<ul style="list-style-type: none"> • Try a different channel. • Adjust antenna. • Press RESET key to restart channel search. 	11
Blue Screen with Video1, Video2, or Component2 displayed.	<ul style="list-style-type: none"> • Check Audio/Video connections. • Check external equipment. • Check external equipment setting. • check DVD setting. 	<ul style="list-style-type: none"> • Press INPUT key. • Switch on external equipment. • Set external equipment output connections to match input connections. 	6 ~ 8
No TV Stereo or SAP sound.	<ul style="list-style-type: none"> • Check if station is broadcasting a true MTS stereo signal or a SAP signal. 	<ul style="list-style-type: none"> • Select STEREO or SAP from Audio on-screen menu. 	11
Cannot select or scan some channels.	<ul style="list-style-type: none"> • Channel may be removed from memory. • Check antenna connections. • V-Guide is set to block programming. 	<ul style="list-style-type: none"> • Select CH. SCAN MEMORY and manually add channels or start CH. (channel) search. • Set V-GUIDE to OFF or press RESET key to clear all setting. 	11 13 ~ 14
Remote Control will not work TV.	<ul style="list-style-type: none"> • Check the batteries. • Check if TV is plugged in. 	<ul style="list-style-type: none"> • Replace batteries. • Aim remote control at front of TV. 	9 ~ 10
Menu System words seem misspelled.	<ul style="list-style-type: none"> • May be a different language is selected. 	<ul style="list-style-type: none"> • Reselect menu language choice using the on-screen menu. 	10
Cabinet makes popping sound.	<ul style="list-style-type: none"> • This is a normal condition during warm-up and cool down of the plastic cabinet parts. 		

Need help? Visit our Web site at www.sanyoctv.com or Call **1-800-877-5032**

MEXICO GUARANTEE

IMPORTADOR:

COMERCIALIZADORA MEXICO
AMERICANA, S.DE R.L. DE C.V.
AV. NEXTENGO N° 78
COL. SANTA CRUZ ACAYUCAN
DEL. AZCAPOTZALCO, MÉXICO, C.P. 02770
RFC: CMA9109119L0

DESCRIPTION: Television
BRAND: SANYO
MODEL: DS24425

GUARANTEE

THE APPARATUS THAT YOU HAVE ACQUIRED HAS A ONE YEAR GUARANTEE FOR MANUFACTURING DEFECTS AND A ONE YEAR SERVICE WARRANTY FROM THE DATE OF PURCHASE GRANTED BY:

COMERCIALIZADORA MEXICO-AMERICANA, S. DE R.L. DE C.V.

UNDER THE FOLLOWING CONDITIONS:

1. TO MAKE THE GUARANTEE EFFECTIVE, SIMPLY SHOW THIS POLICY FILLED OUT BY THE STORE OR SUPPLIER UNIT OR THIS SALES INVOICE, WITH THE APPARATUS IN ANY OF THE SERVICE CENTERS INDICATED ON THIS GUARANTEE.
2. IF THE FAULT IS ATTRIBUTED TO A MANUFACTURING DEFECT, THE APPARATUS WILL BE REPLACED OR YOUR MONEY REFUNDED. DURING THE 30 DAYS SUBSEQUENT TO THE PURCHASE THE GUARANTEE WILL BE VALID AT THE STORE WERE THE APPARATUS WAS PURCHASED, PRESENTING THE ABOVE DOCUMENTS.
3. REPAIR TIME WILL NEVER BE MORE THAN 30 DAYS. IF THIS TIME HAS ELAPSED, AND THE PRODUCT ISN'T REPAIRED, COMERCIALIZADORA MEXICO AMERICANA, S. DE R.L. DE C.V. WILL PROCEED TO EFFECTUATE THE EXCHANGE FOR AN EQUIVALENT APPARATUS OR THE RETURN OF THE BUYING-SALE COST RESPECTIVELY.
4. THIS GUARANTEE WILL COVER ITS TOTALITY OF PIECES, COMPONENTS AND SERVICE REPAIR OF PRODUCT, AND THE RESPECTIVE COST OF TRANSPORTATION.

THIS GUARANTEE WILL BE NULL AND VOID IN THE FOLLOWING CIRCUMSTANCES:

- * WHEN PRODUCT HAS BEEN USED IN A DIFFERENT CONDITION THAN ITS NORMAL USE.
- * WHEN PRODUCT HASN'T BEEN OPERATING CORRECTLY ACCORDING TO THE INSTRUCTIONS IN THIS MANUAL.
- * WHEN PRODUCT HAS BEEN CHANGED OR REPAIRED BY PERSONS NOT AUTHORIZED FROM THE MANUFACTURER, IMPORTER, OR MERCHANT RESPONSIBLE RESPECTIVE.

CENTRO DE SERVICIO Y LUGAR DONDE OBTENER PARTES, COMPONENTES, CONSUMIBLES Y ACCESORIOS:

SUCURSAL VALLEJO
Poniente 126 N° 288 B
Col. Nueva Vallejo
México, D.F.
Tels. 5567-5378
5368-0105, 8589-8033

SUCURSAL MINERVA
Silos N° 135, Col. Minerva
Deleg. Iztapalapa
México, D.F. 09810
Tels. 5646-4551
5646-4550

STAMP, DATE AND SIGNATURE
OF
STORE

DESCRIPTION: _____ BRAND: _____ MODEL: _____

CLIENT'S NAME: _____

ADDRESS: _____

EXTERIOR NUMBER: _____ INTERIOR NUMBER: _____

SUB DIVISION: _____ STATE/DELEGATION: _____

TELEPHONE: _____

16 *Need help?* Visit our Web site at www.sanyoctv.com or Call 1-800-877-5032

UNITED STATES AND CANADA WARRANTY

ONE-YEAR LIMITED WARRANTY

THIS LIMITED WARRANTY IS VALID ONLY ON SANYO TELEVISIONS PURCHASED AND USED IN THE UNITED STATES OF AMERICA, CANADA, AND PUERTO RICO, EXCLUDING THE UNITED STATES' OTHER TERRITORIES AND PROTECTORATES. THIS LIMITED WARRANTY APPLIES ONLY TO THE ORIGINAL PURCHASER, AND DOES NOT APPLY TO PRODUCTS USED FOR INDUSTRIAL OR COMMERCIAL PURPOSES.

FOR ONE YEAR from the date of purchase, Sanyo Manufacturing Corporation will replace any defective TV.

To insure proper warranty exchange, keep the original sales receipt for evidence of purchase. Return the defective TV to the retailer along with the receipt and the included accessories, such as the remote control. The defective TV will be exchanged for the same model, or a replacement model of equal value, if necessary. Replacement model will be contingent on availability and at the sole discretion of Sanyo Manufacturing Corporation.

THE FOREGOING WARRANTY IS EXCLUSIVE AND IN LIEU OF ALL OTHER WARRANTIES OF MERCHANTABILITY OR FITNESS FOR A PARTICULAR PURPOSE.

OBLIGATIONS

For one year from the date of purchase, Sanyo Manufacturing Corporation warrants this product to be free from defects in material and workmanship under normal use and conditions. Should replacement be necessary under this warranty for any reason due to manufacturing defect or malfunction during the first year from date of original purchase, Sanyo Manufacturing Corporation will provide a new TV via exchange at the retailer.

For customer assistance, whether during or out of the warranty period, call toll free 1-800-877-5032.

Weekdays 7:30 AM – 7:00 PM Central Time

Saturday 7:30 AM – 4:00 PM Central Time

This warranty expresses specific contractual rights; retail purchasers may have additional statutory rights which vary from state to state.

(EFFECTIVE: August 1, 2002)

For your protection in the event of theft or loss of this product, please fill in the information requested below and **KEEP IN A SAFE PLACE FOR YOUR OWN PERSONAL RECORDS.**

Model No. _____ Date of Purchase _____

Serial No. _____ Purchase Price _____

(Located on back of unit)

Where Purchased _____



Sanyo Manufacturing Corp.
3333 Sanyo Road, Forrest City, AR 72335

Need help? Visit our Web site at www.sanyoctv.com or Call 1-800-877-5032

17

Free Manuals Download Website

<http://myh66.com>

<http://usermanuals.us>

<http://www.somanuals.com>

<http://www.4manuals.cc>

<http://www.manual-lib.com>

<http://www.404manual.com>

<http://www.luxmanual.com>

<http://aubethermostatmanual.com>

Golf course search by state

<http://golfingnear.com>

Email search by domain

<http://emailbydomain.com>

Auto manuals search

<http://auto.somanuals.com>

TV manuals search

<http://tv.somanuals.com>