

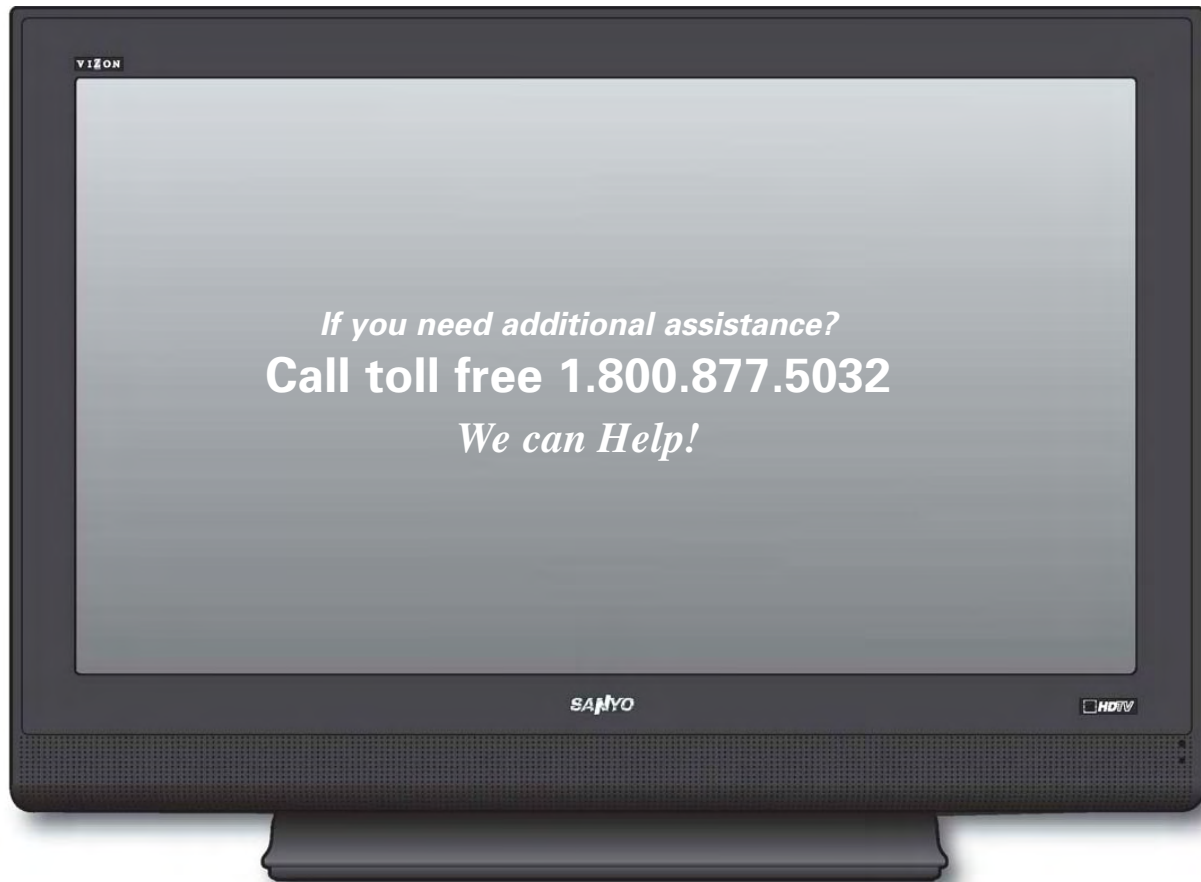

---

Model No: **DP42647**



**Owner's Manual**

Table of Contents . . . . . 5  
Frequent Asked  
Questions (FAQ) . . . . . 47

## ***Welcome to the World of Sanyo***



*Thank you for purchasing this Sanyo High-Definition Digital Television. You made an excellent choice for Performance, Reliability, Features, Value, and Styling.*

### ***Important Information***

*Before installing and operating this DTV, read this manual thoroughly. This DTV provides many convenient features and functions. Operating the DTV properly enables you to manage those features and maintain it in good condition for many years to come.*

*If your DTV seems to operate improperly, read this manual again, check operations and cable connections and try the solutions in the “Helpful Hints” sections of this manual.*

*If the problem still persists, please call **1-800-877-5032. We can help!***

<b>CAUTION</b> RISK OF ELECTRIC SHOCK DO NOT OPEN	THIS SYMBOL INDICATES THAT DANGEROUS VOLTAGE CONSTITUTING A RISK OF ELECTRIC SHOCK IS PRESENT WITHIN THIS UNIT. 
CAUTION: TO REDUCE THE RISK OF ELECTRIC SHOCK, DO NOT REMOVE COVER (OR BACK). NO USER-SERVICEABLE PARTS INSIDE. REFER SERVICING TO QUALIFIED SERVICE PERSONNEL.	THIS SYMBOL INDICATES THAT THERE ARE IMPORTANT OPERATING AND MAINTENANCE INSTRUCTIONS IN THE LITERATURE ACCOMPANYING THIS UNIT. 

**WARNING: TO REDUCE THE RISK OF FIRE OR ELECTRIC SHOCK, DO NOT EXPOSE THIS APPLIANCE TO RAIN OR MOISTURE.**

## IMPORTANT SAFETY INSTRUCTIONS

**CAUTION: PLEASE ADHERE TO ALL WARNINGS ON THE PRODUCT AND IN THE OPERATING INSTRUCTIONS. BEFORE OPERATING THE PRODUCT, PLEASE READ ALL OF THE SAFETY AND OPERATING INSTRUCTIONS. RETAIN THIS LITERATURE FOR REFERENCE. *Follow all instructions...***

1. Read these instructions.
2. Keep these instructions.
3. Heed all warnings.
4. Follow all instructions.
5. Do not use this apparatus near water.
6. Clean only with dry cloth.
7. Do not block any ventilation openings. Install in accordance with the manufacturer's instructions.
8. Do not install near any heat sources such as radiators, heat registers, stoves, or other apparatus (including amplifiers) that produce heat.
9. Do not defeat the safety purpose of the polarized or grounding-type plug. A polarized plug has two blades with one wider than the other. A grounding-type plug has two blades and a third grounding prong. The wide blade or the third prong are provided for your safety. If the provided plug does not fit fully into your outlet, consult an electrician for replacement of the obsolete outlet.
10. Protect the power cord from being walked on or pinched particularly at plugs, convenience receptacles, and the point where they exit from the apparatus.
11. Only use attachments/accessories specified by the manufacturer.
12. Use only with the cart, stand, tripod, bracket, or table specified by the manufacturer, or sold with the apparatus. When a cart is used, use caution when moving the cart/apparatus combination to avoid injury from tip-over.
13. Unplug this apparatus during lightning storms or when unused for long periods of time.
14. Refer all servicing to qualified service personnel. Servicing is required when the apparatus has been damaged in any way, such as power-supply cord or plug is damaged, liquid has been spilled or objects have fallen into the apparatus, the apparatus has been exposed to rain or moisture, does not operate normally, or has been dropped.



**(CONTINUED ON NEXT PAGE.)**

# IMPORTANT SAFETY INSTRUCTIONS

**CAUTION: PLEASE ADHERE TO ALL WARNINGS ON THE PRODUCT AND IN THE OPERATING INSTRUCTIONS. BEFORE OPERATING THE PRODUCT, PLEASE READ ALL OF THE SAFETY AND OPERATING INSTRUCTIONS. RETAIN THIS LITERATURE FOR REFERENCE. Follow all instructions...**

15. If an outside antenna is connected to the television equipment, be sure the antenna system is grounded so as to provide some protection against voltage surges and built up static charges. In the U.S. Selection 810-21 of the National Electrical Code provides information with respect to proper grounding of the mast and supporting structure, grounding of the lead-in wire to an antenna discharge unit, size of grounding conductors, location of antenna discharge unit, connection to grounding electrodes, and requirements for the grounding electrodes.
16. An outside antenna system should not be located in the vicinity of overhead power lines or other electrical light or power circuits, or where it can fall into such power lines or circuits. When installing an outside antenna system, extreme care should be taken to keep from touching such power lines or circuits as contact with them might be fatal.
17. Wall or Ceiling Mounting—The product should be mounted to a wall or ceiling only as recommended by the manufacturer.

18. "Apparatus shall not be exposed to dripping or splashing and no objects filled with liquids, such as vases, shall be placed on the apparatus."
19. When the MAINS plug is used as the disconnect device, the disconnect device shall remain readily operable.

## EXAMPLE OF ANTENNA GROUNDING ACCORDING TO NATIONAL ELECTRICAL CODE, ANSI/NFPA 70

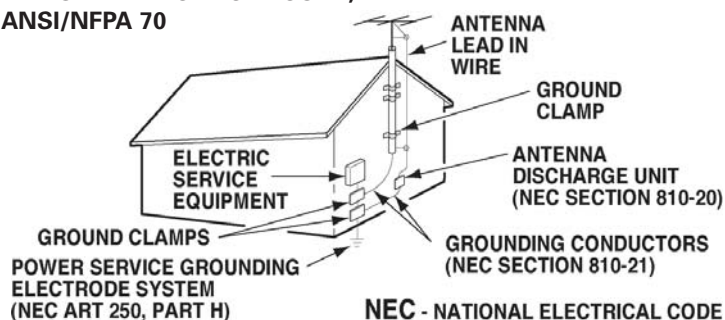

"Note to CATV system installer:

This reminder is provided to call the CATV system installer's attention to Article 820-40 of the NEC that provides guidelines for proper grounding and, in particular, specifies that the cable ground shall be connected to the grounding system of the building, as close to the point of cable entry as practical."

## PROTECTING THE LCD DTV SCREEN

The screen is likely to be damaged if it is not maintained properly. Do not use hard objects such as hard cloth or paper. Do not use excessive pressure when cleaning the screen; excessive pressure can cause permanent discoloration or dark spots.



NEVER spray liquids on the screen.

## HANDLING PRECAUTIONS

- Handle by the cabinet only. Never touch the screen when handling.
- Excessive pressure on the screen can cause permanent discoloration or dark spots.
- Handling damage is **not** covered under warranty.

# CONTENTS

<b>TO THE OWNER</b> .....	2
<b>IMPORTANT SAFETY INSTRUCTIONS</b> .....	3 ~ 4
<b>FEATURES</b> .....	6
<b>SPECIFICATIONS</b> .....	7
<b>DTV BACK LEFT SIDE PANEL—JACKS LOCATIONS &amp; FUNCTIONS</b> .....	8
<b>DTV BACK RIGHT SIDE PANEL—JACKS LOCATIONS &amp; FUNCTIONS</b> .....	9 ~ 10
<b>OPTIONAL FEATURES</b> .....	11
<b>POSITIONING THE LCD DTV</b> .....	11
<b>GLOSSARY OF CABLES</b> .....	12
<b>CHOOSE YOUR CONNECTION</b> .....	13
<b>GETTING STARTED (REQUIRED INITIAL SETUP)</b> .....	14
Installing two “AA” Batteries .....	14
Initial Signal Connections Integrated Digital (DTV) / Analog (RF) Antenna Connection .....	14
All Channel Search .....	15
<b>DIGITAL AV CONNECTIONS</b>	
<b>HDMI CONNECTIONS</b>	
OPTION 1: Connect a DVD Player or Game System .....	16
<i>Helpful Hints for HDMI Input 2/3 connections</i> .....	16
OPTION 2: Connect a Set-Top (STB) to DVI .....	17
<i>Helpful Hints for HDMI Input 1 connections</i> .....	17
<b>VIDEO2 / VIDEO3 Component Jacks</b>	
OPTION 1: Connect a Set-Top (STB) .....	18
<i>Helpful Hints for Video2/3 connections</i> .....	18
OPTION 2: Connect a DVD Player .....	19
<i>Helpful Hints for Video2/3 connections</i> .....	19
OPTION 3: Connect a Game System .....	20
<i>Helpful Hints for Video2/3 connections</i> .....	20
<b>ANALOG AV CONNECTIONS</b>	
<b>VIDEO1 COMPOSITE JACKS</b>	
OPTION 1: Connect Analog Cable, Cable Box, VCR, and an Antenna .....	21
<i>Helpful Hints for Video1 connections</i> .....	21
OPTION 2: Connect Analog Cable, VCR, and an Antenna ..	22
<i>Helpful Hints for Video1 connections</i> .....	22
OPTION 3: Connect a DVD Player .....	23
<i>Helpful Hints for Video1 connections</i> .....	23
<b>AUDIO CONNECTIONS</b>	
Connecting an AV Receiver .....	24
<i>Helpful Hints for Digital Audio Out connections</i> .....	24
Connecting a Stereo Amplifier .....	25
<i>Helpful Hints for Analog Audio Out connections</i> .....	25

## USING THE REMOTE CONTROL

Remote Control Keys (functions) .....	26 ~ 29
<i>Helpful Hints for Remote Control</i> .....	29

## DTV ADJUSTMENT AND SETUP

How to Operate the On-Screen Menu .....	30
Menu Navigation Map .....	30

## MENU OPTIONS

All Channel Search .....	31
Digital Cable Search (Optional) .....	32
<i>Helpful Hints for Digital Cable Search</i> .....	32
Digital Add-On Search .....	33
<i>Helpful Hints for Digital Add-On Search</i> .....	33
Analog Antenna Signal (Optional) .....	34
<i>Helpful Hints for Analog Antenna Signal</i> .....	34
Channel Scan Memory: Deleting Channels .....	35
<i>Helpful Hints for Channel Scan Memory</i> .....	35
Channel Scan Memory: Adding Channels .....	36
<i>Helpful Hints for Channel Scan Memory</i> .....	36
Digital Caption .....	37
Changing the Look of Digital Captioning .....	37
To View Captions .....	38
<i>Helpful Hints for Digital Caption</i> .....	38
V-Guide (Parental Control) .....	39
To Block MPAA Movie or TV Programs .....	39
To Setup V-Guide Ratings .....	39
On-Screen View of Blocked TV program .....	40
To Temporarily Unblock MPAA Movie or TV Rating ..	40
To Unblock All MPAA Movie or All TV Rating .....	40
TV Ratings (Age and Content-Based)	
Symbol Explanation .....	41
MPAA Movie Ratings (Age-Based)	
Symbol Explanation .....	41
Picture/Sound Adjustment .....	42 ~ 43
<i>Helpful Hints for Picture/Sound</i> .....	43
Menu Language .....	44
Energy (Power) Saver .....	45
<b>GLOSSARY OF TERMS</b> .....	46
<b>FAQ (FREQUENTLY ASKED QUESTIONS)</b> .....	47
<b>WARRANTY</b> .....	48

## FEATURES

- ◆ 42" Wide-Screen LCD-HDTV
- ◆ Detachable Stand
- ◆ Trilingual Menu Options (English, Spanish, or French)
- ◆ Integrated Digital/Analog Tuner
- ◆ Energy Saver Mode (Backlight)
- ◆ Automatic Channel Search
- ◆ 3-D Y/C Comb Filter
- ◆ V-Chip for Movies and TV guidelines rating limits (parental control)
- ◆ Closed-Captioning: Analog EIA-608B  
Digital EIA-708B
- ◆ Audio Modes: Digital—Main and Sub  
Analog—Stereo, Mono, and SAP
- ◆ Front speakers (two): 6 x 12 cm
- ◆ Factory preset adjustments for picture/sound: Auto, Manual with Tone Control
- ◆ Picture Shape: PIX1 ~ PIX4
- ◆ Audio Format: Dolby® Digital for ATSC (DTV) and Analog for NTSC
- ◆ Receivable Formats: Digital Tuner for ATSC terrestrial broadcasts and nonscrambled (ClearQAM) cable channels.  
NTSC analog tuner for VHF/UHF or CATV
- ◆ Channel Scan Memory
- ◆ Receives 181 Analog Channels (VHF 2~13 and UHF 14~69; Cable 14~125); and 99 Digital Channels
- ◆ XDS (Extended Data Services) displays station call letters, title of show, and ratings when broadcast
- ◆ Sleep Timer (3 hours)
- ◆ 32-Key Remote Control
- ◆ TERMINIAL and CONNECTORS:  
RF Antenna Input Jack: Digital and Analog  
HDMI (w/HDCP) (Three sets)  
Component Video (Y-Pb-Pr) Input (Two Sets)  
S-Video Input  
Rear Composite AV Input Jacks  
Coaxial Digital Audio Out  
Fixed Audio (Left/Right) Out

# SPECIFICATIONS

SCREEN SIZE:	42" Wide-Screen
SCANNING FORMAT:	720p (All Signals are Converted to 720p)
RESOLUTION (PANEL):	1366 x 768 (WXGA)
RF ANTENNA INPUT:	75 ohm—Digital/Analog
POWER REQUIREMENT:	Source: AC 120V, 60Hz
POWER CONSUMPTION:	224 Watts (Average)
SOUND:	Two Speakers, size: 6 x 12 cm
MOUNTING BRACKET:	Vesa Standard or Universal 400 x 400
AMPLIFIER:	Built-in with 5.0W/ch
JACKS / CONNECTORS:	
VIDEO1	Composite Video and Audio R/L S-Video
VIDEO2	Component (Y/ Pb/Pr) with Audio R/L Input
VIDEO3	Component (Y/ Pb/Pr) with Audio R/L Input
Digital Audio Output:	Dolby® Digital (Coaxial Cable)
Analog Audio Output:	Audio R/L
HDMI 1 Input:	19-pin connector (Picture/Sound with HDCP)
HDMI 2 Input:	19-pin connector (Picture/Sound with HDCP)
HDMI 3 Input:	19-pin connector (Picture/Sound with HDCP) HDMI3 with DVI Interface port

## SIZE AND WEIGHT (APPROXIMATELY):

Horizontal Dim. (Width):	41.3 in. (1049mm)
Vertical Dim. (Height):	29.7 in. (755mm)
Depth Dim. (Thickness):	10.2 in. (258mm)
Weight:	55.1 (lbs.) 25.0(Kg)

Specifications are subject to change without notice.

CAUTION: FCC Regulations state that improper modifications or unauthorized changes to this unit may void the user's authority to operate the unit.

## Trademarks Information:

Manufactured under license from Dolby Laboratories. "Dolby" is a trademark of Dolby Laboratories.

**VIZON®** with a double "Z" is a registered trademark of Sanyo Manufacturing Corporation.



This symbol on the nameplate means the product is Listed by Underwriters' Laboratories Inc. It is designed and manufactured to meet rigid U.L. safety standards against risk of fire, casualty and electrical hazards.



"As an ENERGY STAR® Partner, Sanyo Manufacturing Corporation has determined that this product meets the ENERGY STAR® guidelines for energy efficiency."

## RIGHT SIDE PANEL (VIEWED FROM FRONT)

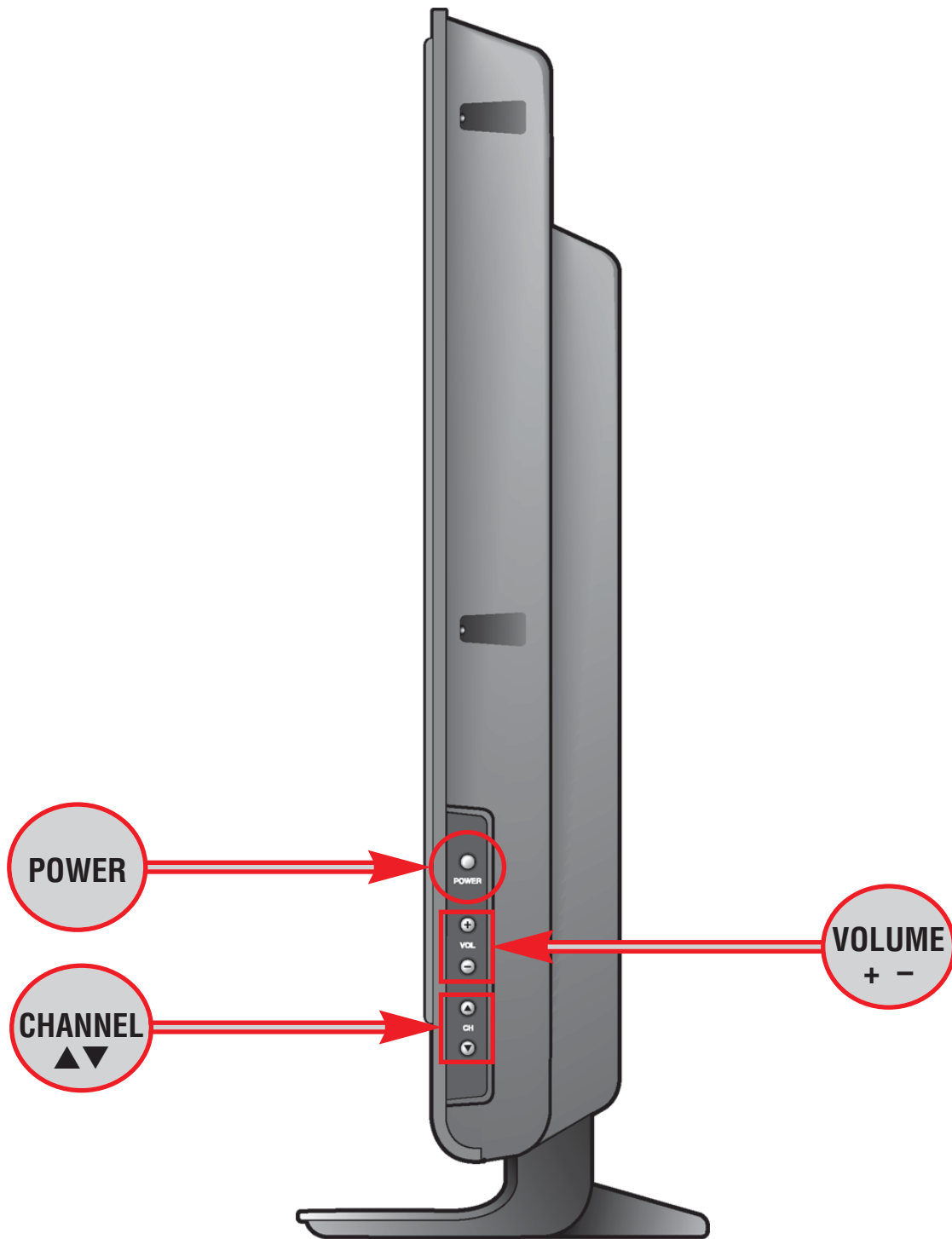

These keys operate exactly like the Remote Control keys.  
(Go to page 24, for more detail information, if needed.)



## DTV BACK—RIGHT SIDE (VIEWED FROM BACK)

**S-Video Input (VIDEO1)**—To enhance video detail use the S-Video jack instead of the Video jack, if available on your external equipment. (S-Video connection will override a connection to the Video input jack [VIDEO1]). **See PAGES 19 and 21 for S-Video connection.**

**Component Video Input (VIDEO2 or VIDEO3)**—Connect digital video equipment to the Y (green), Pb (blue), Pr (red) and Audio L/R jacks. These jacks will automatically detect the type of signal being received. **See PAGES 16, 17, and 18 for Component jack connections.**

**Analog Audio Out (L/R) Jacks**—Connect external audio equipment here. **See PAGE 23 for Audio Out jack connections.**

**Analog / Digital Antenna Input**—Connect an RF antenna or Analog Cable system to this jack. **See PAGE 14 for Signal connections.**

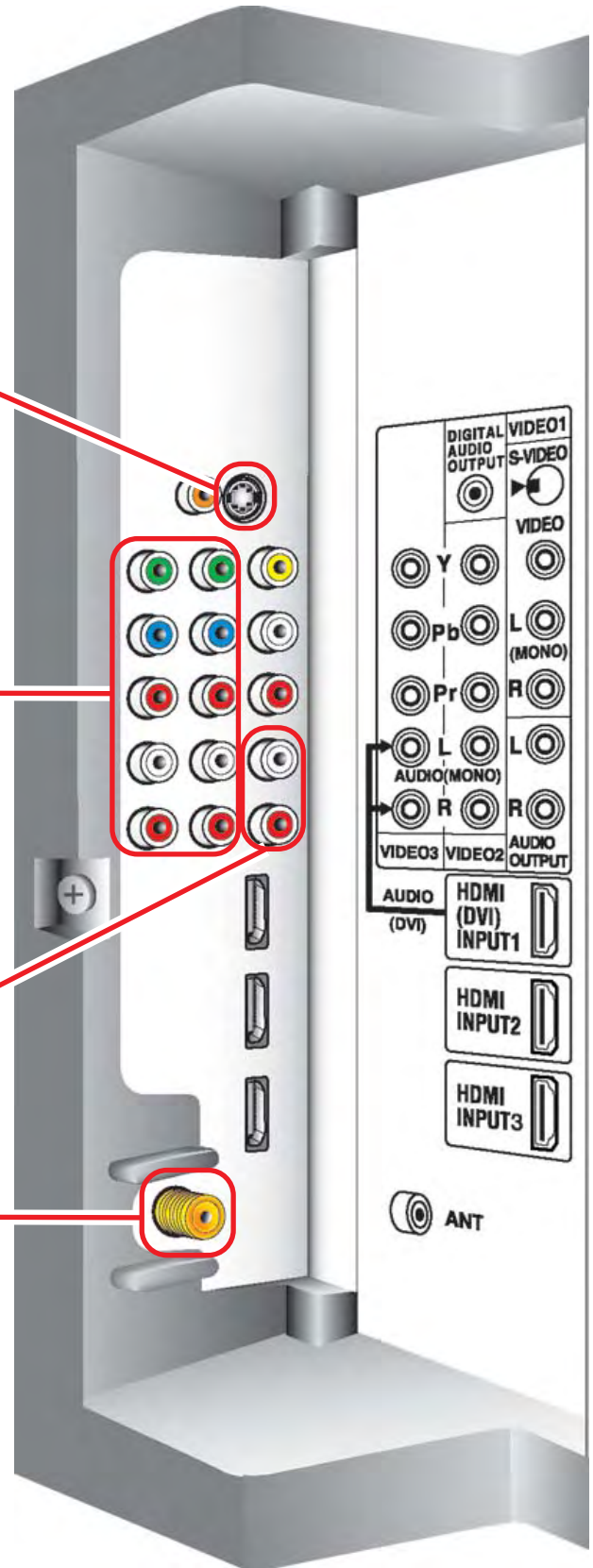

(CONTINUED ON NEXT PAGE.)

**Digital Audio Output**—Use a Phono-Type Coaxial Digital Audio Out Cable to connect Digital Audio Output to an advanced stereo home theater system equipped with Dolby® Digital 5.1. **See PAGE 22 for Digital Audio Out jack connection.**

**Audio/Video Input (VIDEO1)**—Connect analog video equipment here. **See PAGES 19, 20, and 21 for AV VIDEO1 jack connection.**

*Note: S-Video connection overrides the (Video1) composite video connection.*

**HDMI INPUT1/2/3 (High-Definition Multimedia Interface), PAGE 7**—Connect digital video equipment to this jack. It takes only one cable (not supplied) to communicate between audio/video equipment and this DTV. HDMI (DVI) INPUT1 jack is compatible with DVI equipped AV devices. (Separate audio connection and an adapter are required for DVI device.) **See PAGES 19, 20, and 21 for HDMI connection.**

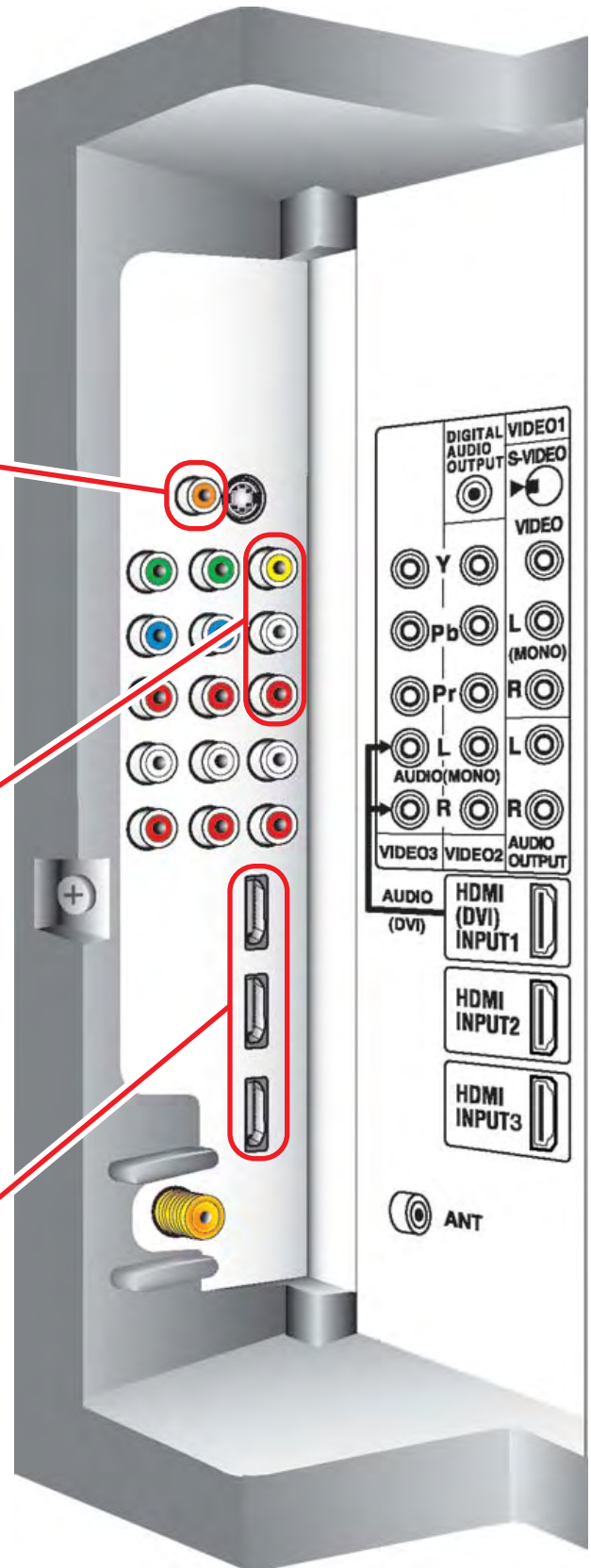

## OPTIONAL FEATURES

### WALL MOUNTING

Use the threaded inserts on the back of your DTV to secure it using a wall mounting kit. (VESA standard interface 200 x 200.)

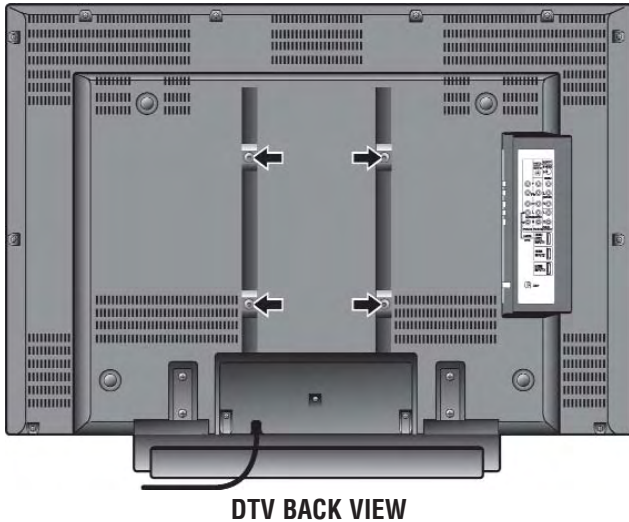

DTV BACK VIEW

Note: Wall Mounting kit is not supplied.  
LCD Mounting screws measurements:  
M6 Diameter, Length—12mm (maximum).

### REMOVING THE DTV STAND (Optional)

**Tools Needed:** Phillips screwdriver

**Important Note:** Place DTV face down on a padded or cushioned surface to protect the screen and finish. Handling by more than two people is recommended.

1 Remove four (4) screws from the metal bracket. **CAUTION:** Hold the stand firmly as you remove the last screw.

2 Carefully remove the DTV stand.

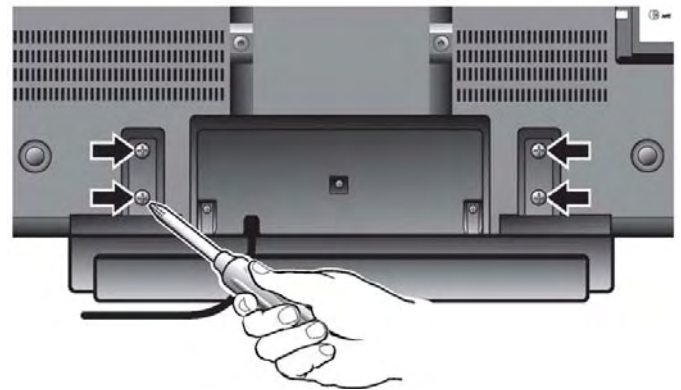

## POSITIONING THE LCD DTV

Always use an appropriate table or stand when positioning your DTV. **Do not position the DTV in a confined area. Allow adequate space for proper ventilation.**

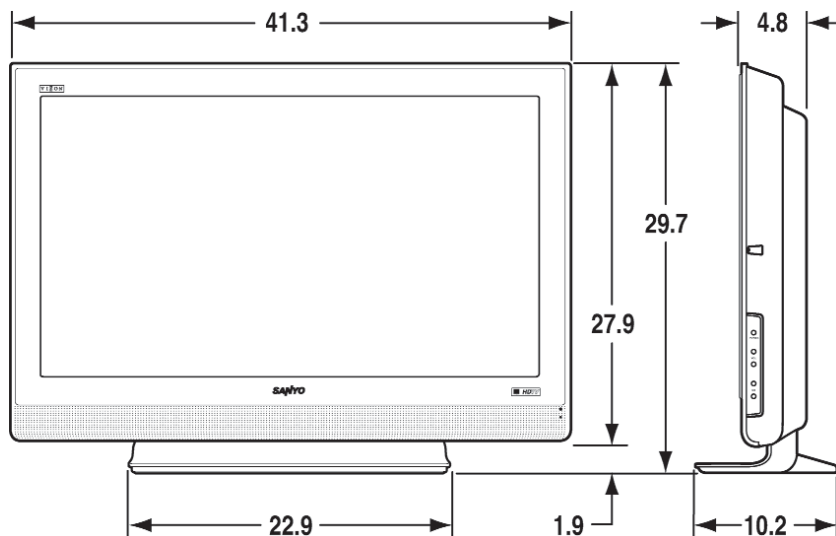

Note: All dimensions are in inches.

## GLOSSARY OF CABLES

**Audio Cables**—Provides analog left/right audio for your external equipment connections.

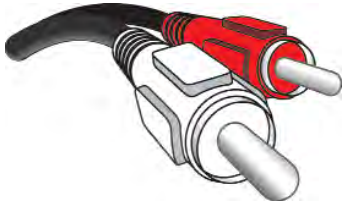

**75 Ohm Coaxial Cable with F-Connector**—Used to connect a signal to your digital or Analog RF Antenna In terminal.



**Component: Y, Pb, Pr**—Use these cables to connect your component equipment. This connection provides the best picture, but does not include sound. (Cable colors: Y = green, Pb = blue, and Pr = red.)

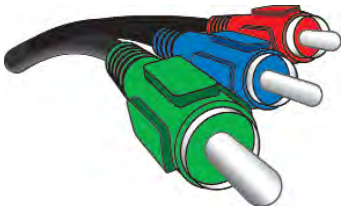

**Coaxial Digital Audio**—Use this cable to connect the DTV's digital audio output to a multichannel audio receiver.



**Composite Audio/Video (RCA type)**—Use these cables for standard analog audio/video connections. Normally cables are color coded: Yellow for Video, White for (L) Audio, and Red for (R) Audio.

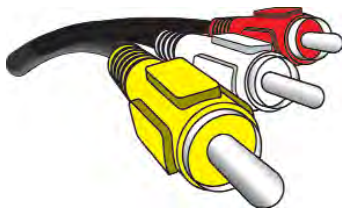

**S-Video Cable**—This cable provides separate luminance and color signals for higher resolution and better picture quality. Use this cable instead of the regular composite video cable (RCA type), when available.













*NOTE: None of these cables are supplied with this DTV.*

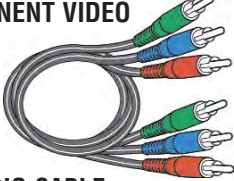
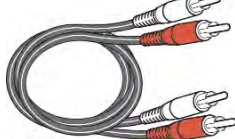

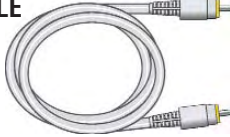
# CHOOSE YOUR CONNECTION

This DTV is designed to handle several different connections making it compatible with Digital and Analog devices.

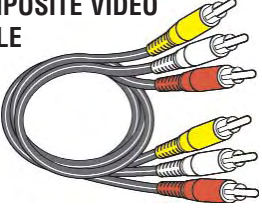
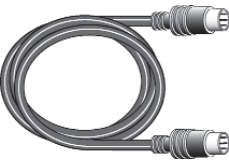
In order to receive the best performance from your DTV, choose your connection using this chart; then go to the specified page for detailed instructions.

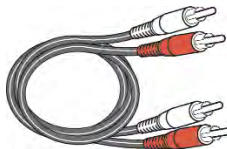
Digital Signal Connections	Compatible External Equipment	Cables Needed (Not Supplied)	Go to Page
<b>HDMI</b> <i>Will accept HDTV (High Bandwidth Video component)</i>	  <p><b>DIGITAL SET-TOP BOX or DVD PLAYER</b></p> <p><b>VIDEO GAME</b></p>	 <p><b>19 PIN HDMI</b></p>	<b>16</b> <b>17</b> <b>18</b>
<b>COMPONENT (Y, Pb, Pr) IN</b> <i>Will accept HDTV, EDTV, or SDTV Video content.</i> <i>(Requires separate audio connections.)</i>	  <p><b>DIGITAL SET-TOP BOX or DVD PLAYER</b></p> <p><b>VIDEO GAME</b></p>	  <p><b>COMPONENT VIDEO CABLE</b></p> <p><b>AUDIO CABLE</b></p>	<b>16</b> <b>17</b> <b>18</b>
<b>DIGITAL AUDIO OUT</b> <i>(Only available when received as part of the Digital RF signal displayed on-screen.)</i>	  <p><b>AV RECEIVER</b></p>	 <p><b>COAXIAL DIGITAL CABLE</b></p>	<b>22</b>
Analog Signal Connections	Compatible External Equipment	Cables Needed (Not Supplied)	Go to Page
<b>COMPOSITE VIDEO OR S-VIDEO IN</b>  <b>LEFT / RIGHT ANALOG AUDIO IN</b>	  <p><b>DVD PLAYER</b></p>  <p><b>VCR</b></p>	  <p><b>COMPOSITE VIDEO CABLE</b></p> <p><b>S-VIDEO CABLE</b></p>	<b>19</b> <b>20</b> <b>21</b>
<b>ANALOG AUDIO OUT JACKS</b>	  <p><b>STEREO AMPLIFIER SYSTEM</b></p>	 <p><b>AUDIO CABLE</b></p>	<b>23</b>

## GETTING STARTED (REQUIRED INITIAL SETUP)

- 1** Install batteries in remote control (2AA, not included).



### PRECAUTIONS

To ensure safe operation, please observe the following precautions:

Replace both batteries at the same time. Do not use a new battery with a used battery.

Risk of explosion, if battery is replaced by an incorrect type.

Do not expose the Remote Control Unit to moisture or heat.

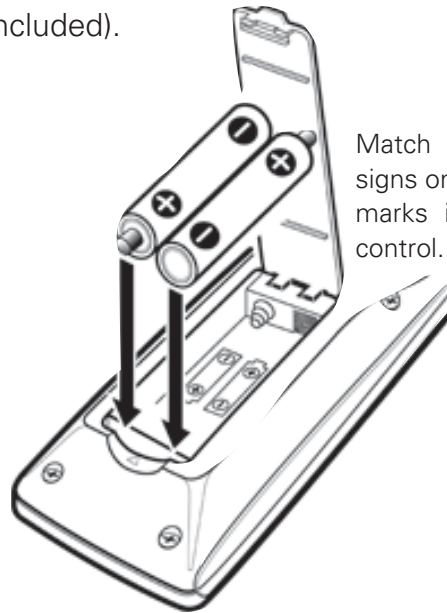

Match the "+" and "-" signs on the batteries with marks inside the remote control.

- 2** Connect Signal to the DTV's Integrated Analog / Digital 75 ohm Antenna Input terminal.

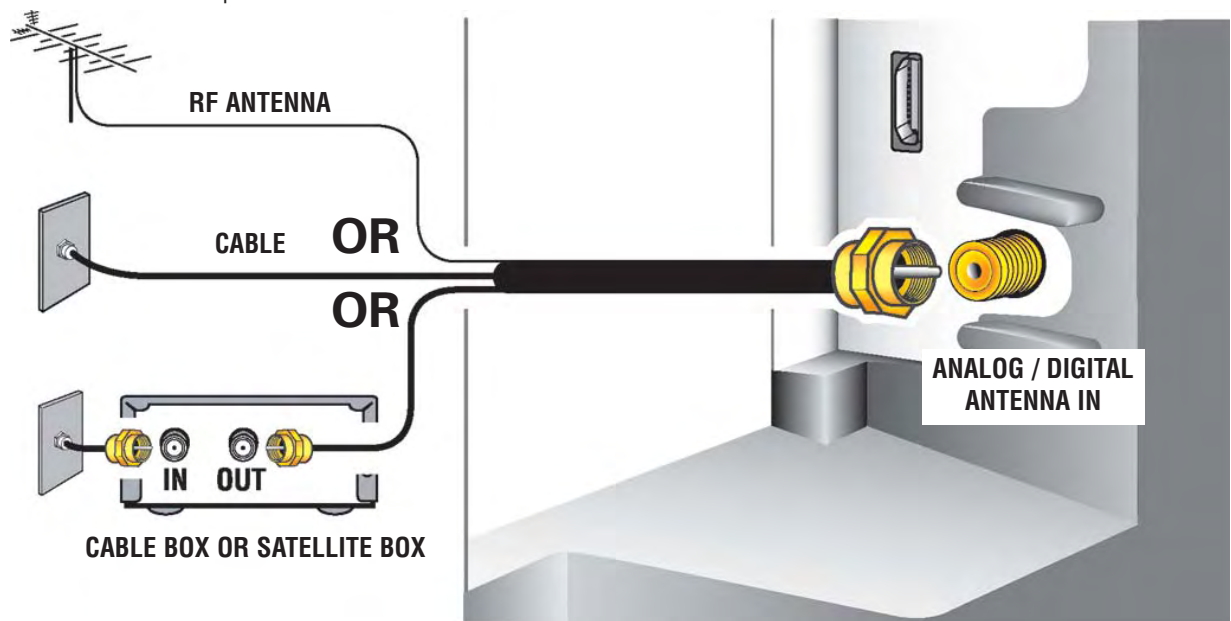

DTV RIGHT SIDE (VIEWED FROM BACK)

*THE TUNER IN THIS DTV CAN RECEIVE:*

1. Digital and / or Analog Off-Air Signals from an RF antenna.

OR

2. Analog or ClearQAM cable channels.

Note: You must search for ClearQAM channels using the "Digital Cable Search" menu option.

OR

3. The output from a VCR or cable box.

Digital signals from a Set-top (STB) Box should be received through the Component jacks.

This DTV can receive ANY unscrambled RF signal being broadcast.

(CONTINUED ON NEXT PAGE.)

# GETTING STARTED (REQUIRED INITIAL SETUP) *Continued*

- 3** Plug AC Power Cord (supplied) into an electrical outlet as shown here.

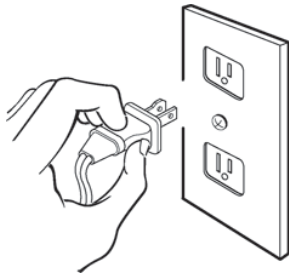

To 120 V AC outlet.

- 4** Press the **POWER** key. (Follow on-screen instructions).

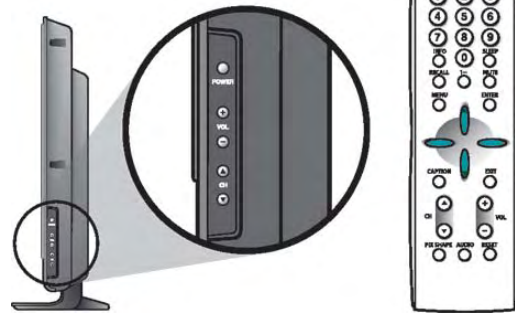

- 5** Perform "All Channel Search." The All Channel Search will search for off-air digital and analog channels, and analog cable channels. The DTV can receive cable or off-air channels, but not at the same time. *If after two searches the DTV still fails to detect any channels, the DTV will tune to Video1.*

*Note: If **EXIT** is pressed, the DTV will skip Channel Search and tune to **Video1** without storing any channels in the Channel Map databases.*

## INITIAL ON-SCREEN ALL CHANNEL SEARCH

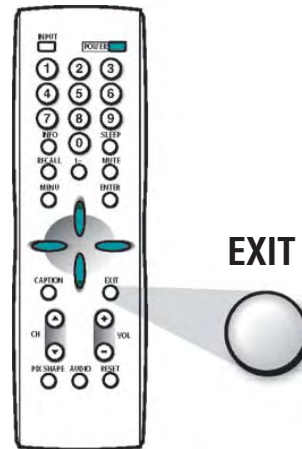
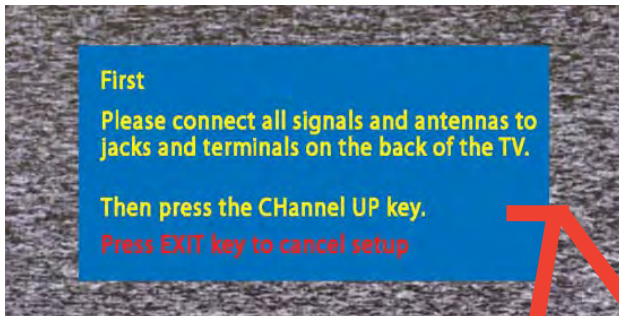

## ANALOG CHANNELS

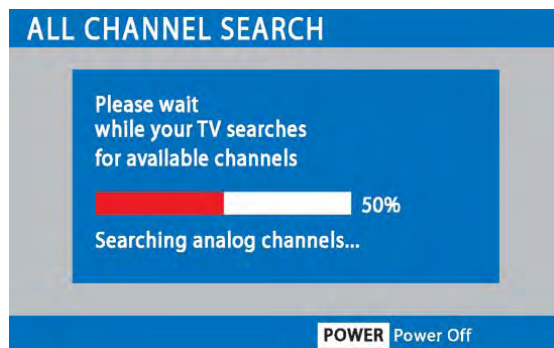

## DIGITAL CHANNELS



## HDMI INPUT 2 OR INPUT 3 CONNECTION: *Connection Option 1*

### HDMI CONNECTIONS (INCLUDES HDCP COPY PROTECTION)—*Receiving the ultimate picture*

1 Connect the external equipment's HDMI Output to a DTV HDMI Input.

2 Press **INPUT** to select HDMI 2 or HDMI 3 to view the digital program.

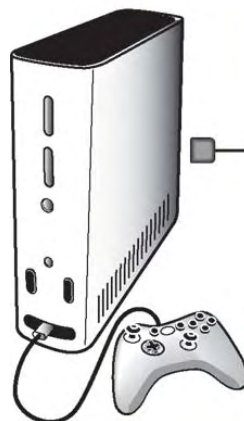
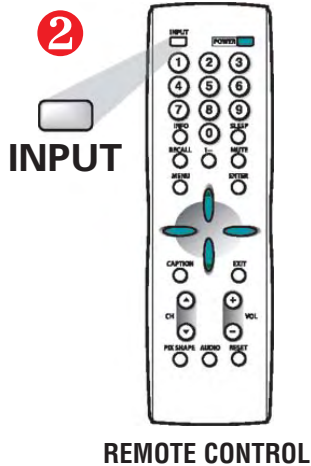

#### DTV HDMI INPUT2 / INPUT 3

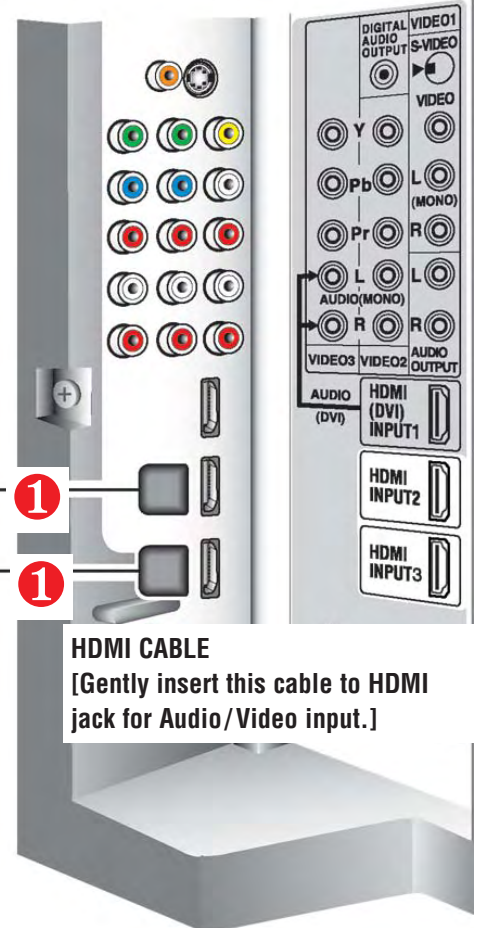

#### OPERATING TIPS:

- ◆ Press the **INPUT** key after connecting cables to access the HDMI2 or HDMI3 input. There is NO need to tune to a blank channel.
- ◆ HDMI INPUT2, and HDMI INPUT3 jacks have identical functions with HDMI INPUT1 having an additional feature for DVI connection. Compatible video devices can be connected to either set of jacks.
- ◆ Refer to the owner's manuals and user's guides that came with your external equipment for connection options.

## HELP HINTS (PROBLEMS/SOLUTIONS)

#### SYMPTOM

"No Signal" will appear randomly on the screen when no signal is detected at the video jack.

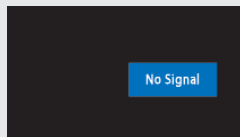

#### CHECK THESE CONDITIONS

- Check Audio/Video connections.
- Check external equipment connections.
- Check external equipment setting.

#### TRY THESE SOLUTIONS

- Press the **INPUT** key.
- Switch on external equipment.
- Set external equipment output connections to match input connections.

*If you continue to experience problems, please call toll free  
**1-800-877-5032. We can Help!***



## HDMI INPUT1 CONNECTION: *Connection Option 2*

### DVI TO HDMI INPUT1 CONNECTIONS (INCLUDES HDCP COPY PROTECTION)—*Receiving the ultimate picture*

- 1 Connect the Set-top Box (STB) DVI Output to the DTV's HDMI INPUT1.
- 2 Connect the STB Audio out to the DTV's VIDEO3 Audio In L/R.

- 3 Press **INPUT** to select *HDMI 1* to view the digital program.

**IMPORTANT FACT:** Only the HDMI INPUT1 jack can accept a DVI (digital video interface) signal.

Note: Check with your local electronics store for a DVI to HDMI Adapter Cable that matches your equipment and the DTV.

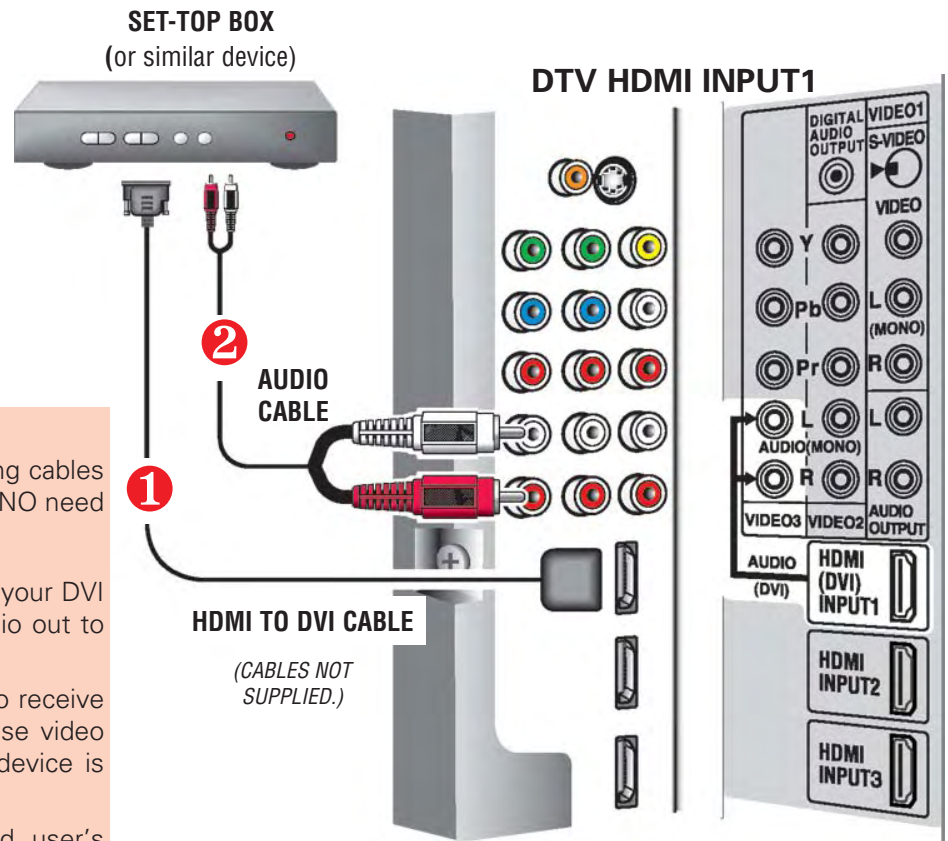
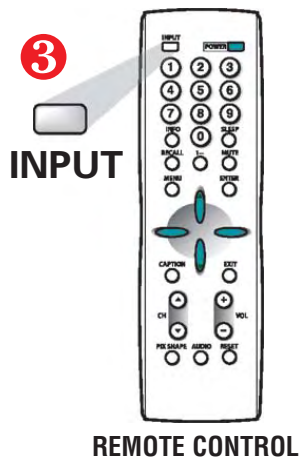

#### OPERATING TIPS:

- ◆ Press the **INPUT** key after connecting cables to access the HDMI1 input. There is NO need to tune to a blank channel.
- ◆ Use HDMI (DVI) INPUT1 to connect your DVI device, make sure you connect Audio out to the DTV's VIDEO 3 Audio In.
- ◆ The VIDEO 3 audio jacks are used to receive the audio from the DVI device. These video jacks cannot be used when a DVI device is connected.
- ◆ Refer to the owner's manuals and user's guides that came with your external equipment for connection options.

## HELP HINTS (PROBLEMS/SOLUTIONS)

#### SYMPTOM

"No Signal" will appear randomly on the screen when no signal is detected at the video jack.

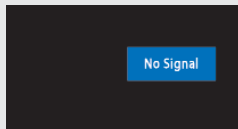

#### CHECK THESE CONDITIONS

- Check Audio/Video connections.
- Check external equipment connections.
- Check external equipment setting.

#### TRY THESE SOLUTIONS

- Press the **INPUT** key.
- Switch on external equipment.
- Set external equipment output connections to match input connections.

*If you continue to experience problems, please call toll free  
1-800-877-5032. We can Help!*

# VIDEO2 & 3 COMPONENT JACKS: *Connection Option 1*

## CONNECTING A SET-TOP (STB)

- 1 Connect a Component Cable to the VIDEO2 Green, Blue, and Red video jacks.
- 2 Connect an Audio Cable to the matching VIDEO2 White and Red audio jacks.

- 3 Press **INPUT** to select *Video 2* to view the program.

*Note: VIDEO2 and VIDEO3 jacks have identical functions. Compatible video devices can be connected to either or both set of jacks.*

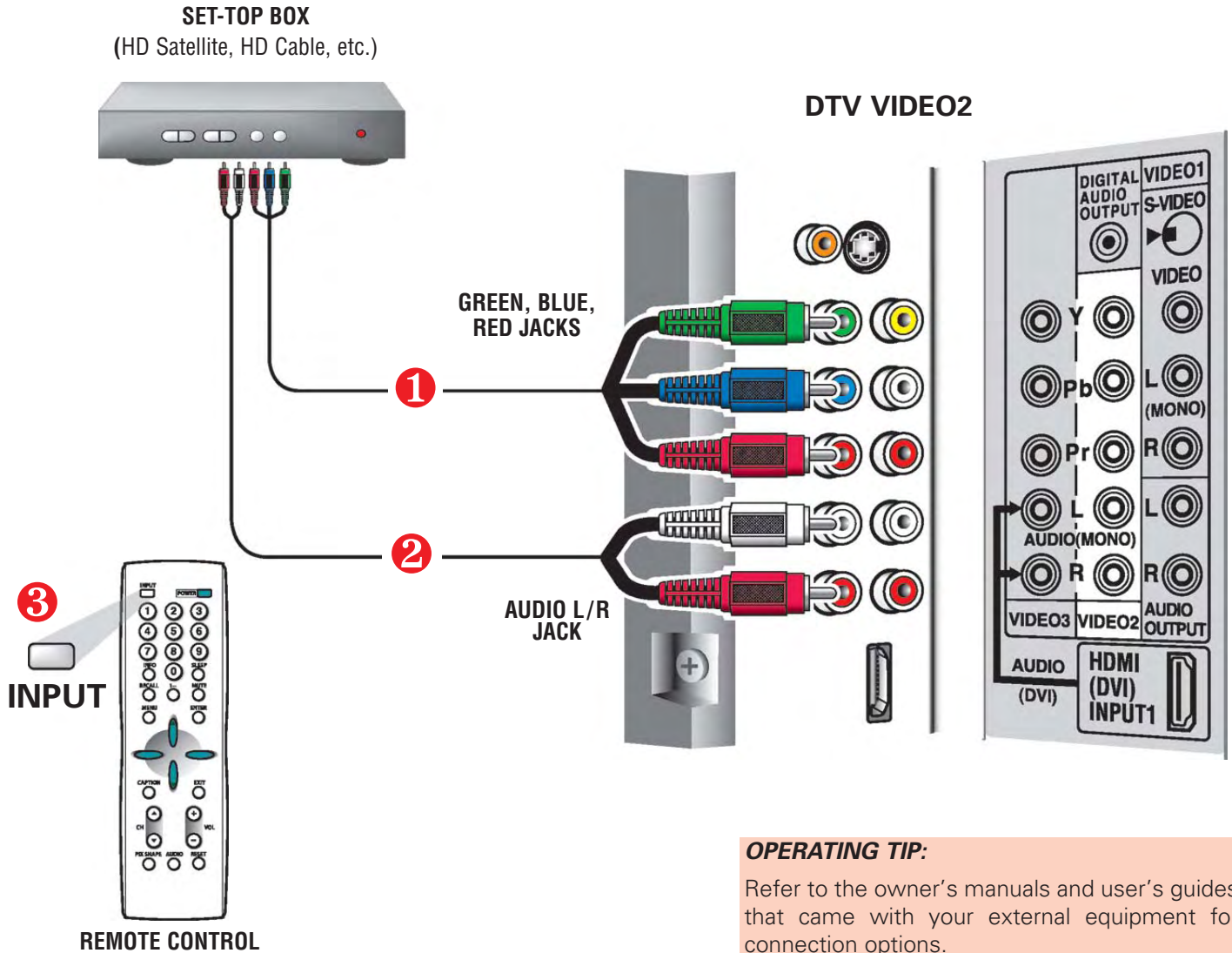

## HELP HINTS (PROBLEMS/SOLUTIONS)

### SYMPTOM

"No Signal" will appear randomly on the screen when no signal is detected at the video jack.

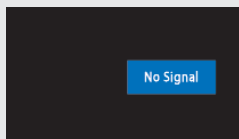

### CHECK THESE CONDITIONS

- Check Audio/Video connections.
- Check external equipment connections.
- Check external equipment setting.

### TRY THESE SOLUTIONS

- Press the **INPUT** key.
- Switch on external equipment.
- Set external equipment output connections to match input connections.

*If you continue to experience problems, please call toll free  
**1-800-877-5032. We can Help!***

# VIDEO2 & 3 COMPONENT JACKS: *Connection Option 2*

## CONNECTING A DVD PLAYER

- 1 Connect a Component Cable to the VIDEO3 Green, Blue, and Red video jacks.
- 2 Connect an Audio Cable to the matching VIDEO3 White and Red audio jacks.

- 3 Press **INPUT** to select *Video 3* to view the program.

*Note: VIDEO2 and VIDEO3 jacks have identical functions. Compatible video devices can be connected to either or both set of jacks.*

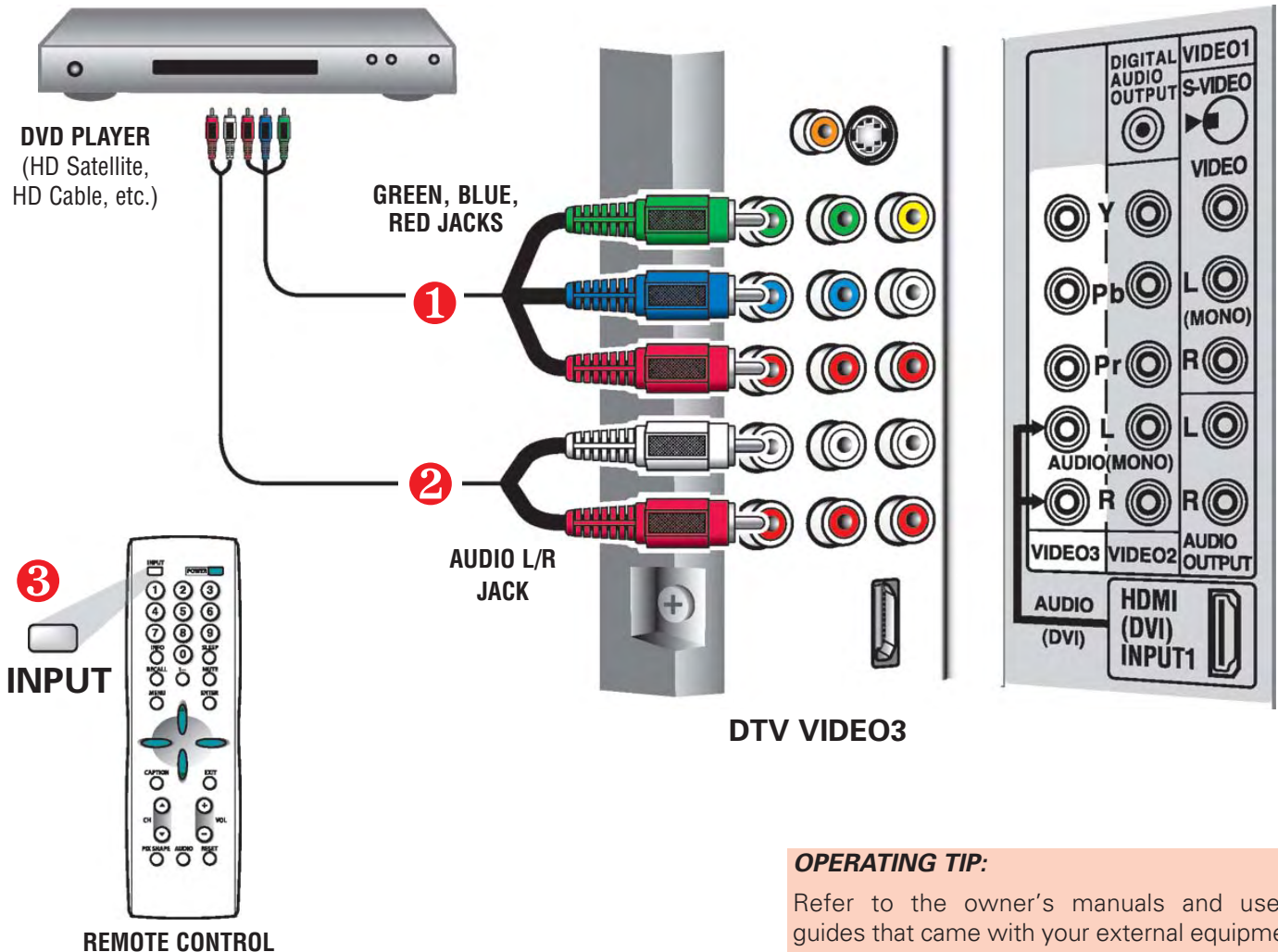

## HELP HINTS (PROBLEMS/SOLUTIONS)

### SYMPTOM

"No Signal" will appear randomly on the screen when no signal is detected at the video jack.

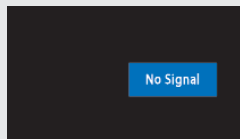

### CHECK THESE CONDITIONS

- Check Audio/Video connections.
- Check external equipment connections.
- Check external equipment setting.

### TRY THESE SOLUTIONS

- Press the **INPUT** key.
- Switch on external equipment.
- Set external equipment output connections to match input connections.

*If you continue to experience problems, please call toll free 1-800-877-5032. We can Help!*

## VIDEO2 & 3 COMPONENT JACKS: *Connection Option 3*

### CONNECTING A GAME SYSTEM

- 1 Connect a Component Cable to the VIDEO2 / 3 Green, Blue, and Red video jacks.
- 2 Connect an Audio Cable to the VIDEO2 / 3 White and Red audio jacks.
- 3 Press **INPUT** to select *Video 2 or Video 3* to view the program.

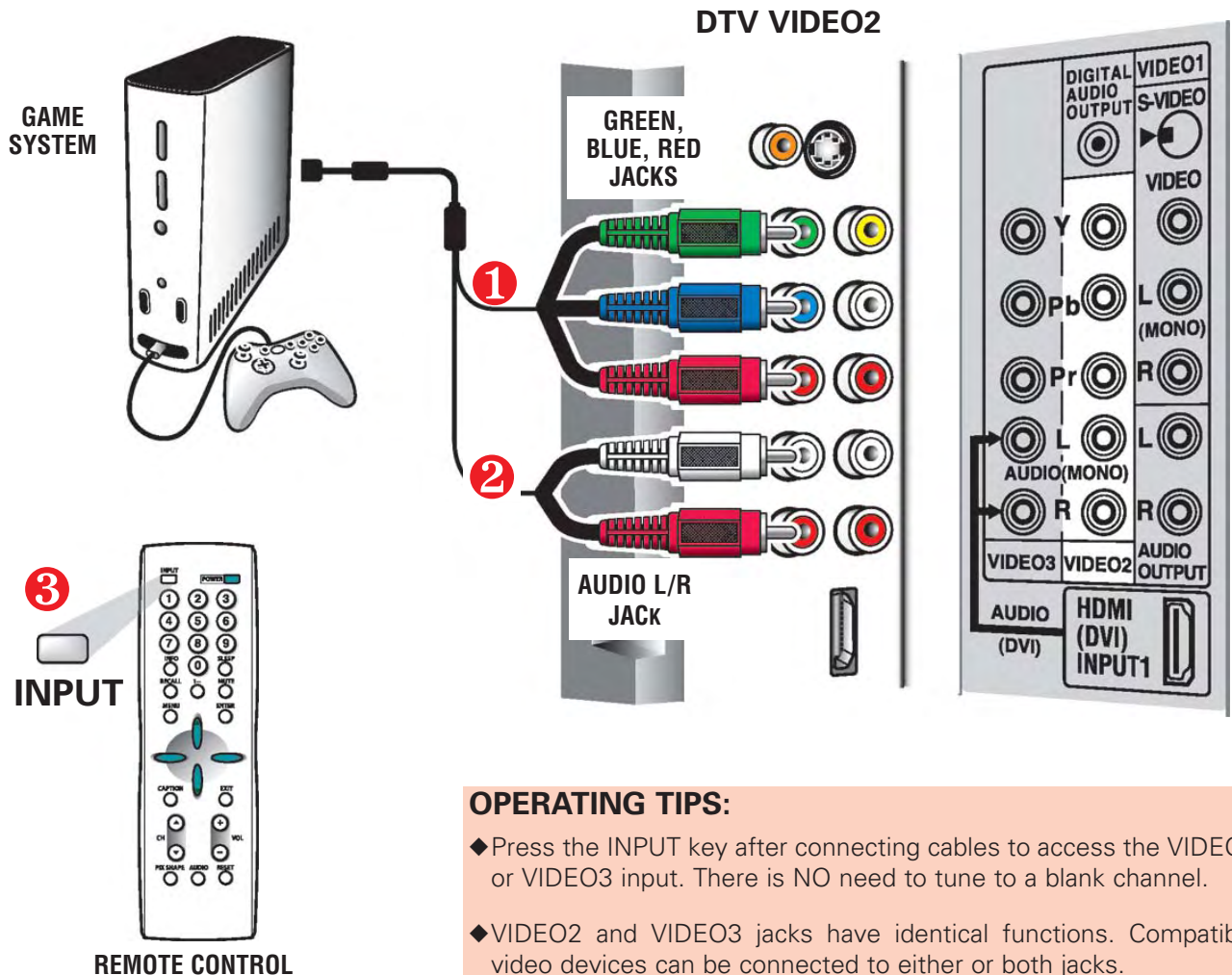

#### OPERATING TIPS:

- ◆ Press the **INPUT** key after connecting cables to access the VIDEO2 or VIDEO3 input. There is NO need to tune to a blank channel.
- ◆ VIDEO2 and VIDEO3 jacks have identical functions. Compatible video devices can be connected to either or both jacks.
- ◆ Refer to the owner's manuals and user's guides that came with your external equipment for connection options.

### HELP HINTS (PROBLEMS/SOLUTIONS)

#### SYMPTOM

"No Signal" will appear randomly on the screen when no signal is detected at the video jack.

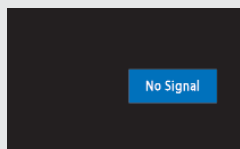

#### CHECK THESE CONDITIONS

- Check Audio/Video connections.
- Check external equipment connections.
- Check external equipment setting.

#### TRY THESE SOLUTIONS

- Press the **INPUT** key.
- Switch on external equipment.
- Set external equipment output connections to match input connections.

*If you continue to experience problems, please call toll free  
1-800-877-5032. We can Help!*

## VIDEO1 COMPOSITE (ANALOG) JACKS: *Connection Option 1*

### CONNECTING ANALOG CABLE, CABLE BOX, VCR, AND AN ANTENNA TO THE DTV

- 1 Connect Analog Cable Box "Antenna Out" to the VCR "Antenna In."
- 2 Connect the VCR AV out jacks to VIDEO1 Yellow, White, and Red jacks.
- 3 *OPTIONAL FOR A SUPER VHS VCR*  
Connect VCR to the DTV S-Video In Jack. Disconnect the VIDEO1 yellow jack.
- 4 Connect an Antenna to the DTV ANT terminal.
- 5 Tune VCR to channel 3 or 4 to match your Cable Box.
- 6 Press **INPUT** to select *Video 1* to watch Analog Cable channels OR to TV channels to watch Antenna channels.
- 7 Select Cable channels with the cable box remote control. Select Antenna channels with the DTV remote control.

Note: S-Video jack connection overrides a Video jack connection (VIDEO1).

**IMPORTANT FACTS:**  
Composite jacks offer only 480i (SDTV) resolution.

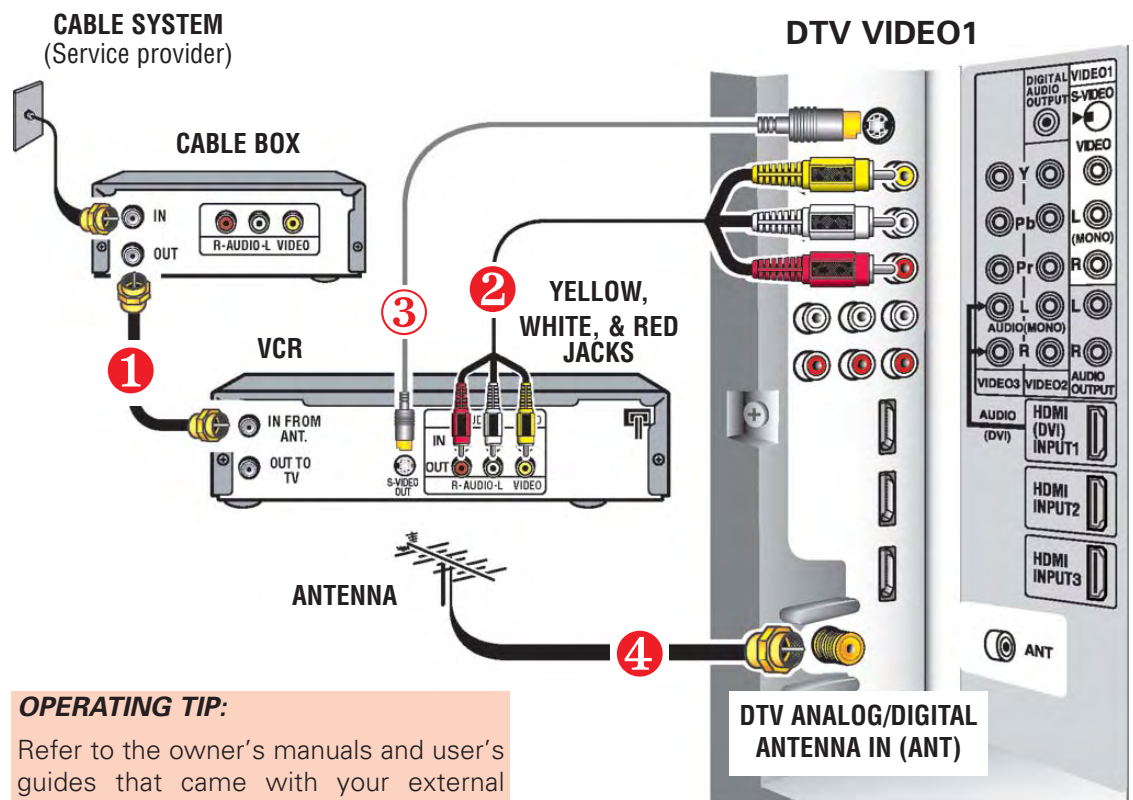
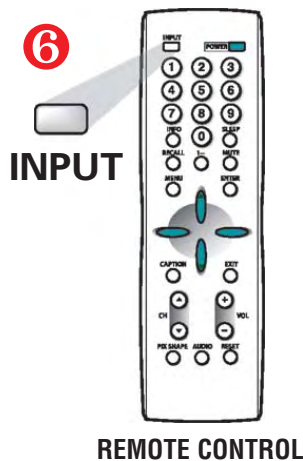

### HELP HINTS (PROBLEMS/SOLUTIONS)

#### SYMPTOM

"No Signal" will appear randomly on the screen when no signal is detected at the video jack.

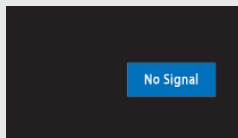

#### CHECK THESE CONDITIONS

- Check Audio/Video connections.
- Check external equipment connections.
- Check external equipment setting.

#### TRY THESE SOLUTIONS

- Press the **INPUT** key.
- Switch on external equipment.
- Set external equipment output connections to match input connections.

*If you continue to experience problems, please call toll free  
1-800-877-5032. We can Help!*

## VIDEO1 COMPOSITE (ANALOG) JACKS: *Connection Option 2*

### CONNECTING ANALOG CABLE, VCR, AND AN ANTENNA TO THE DTV

- 1 Connect Analog Cable system to the VCR "Antenna In."
- 2 Connect the VCR AV out jacks to VIDEO1 Yellow, White, and Red jacks.
- 3 Connect an Antenna to the DTV ANT terminal.
- 4 Press **INPUT** to select *Video 1* to watch Analog Cable channels OR to TV channels to watch Antenna channels.
- 5 Select channels with the VCR's remote control. Select Antenna channels with the DTV remote control.

#### IMPORTANT FACT:

Composite jacks offer only 480i (SDTV) resolution.

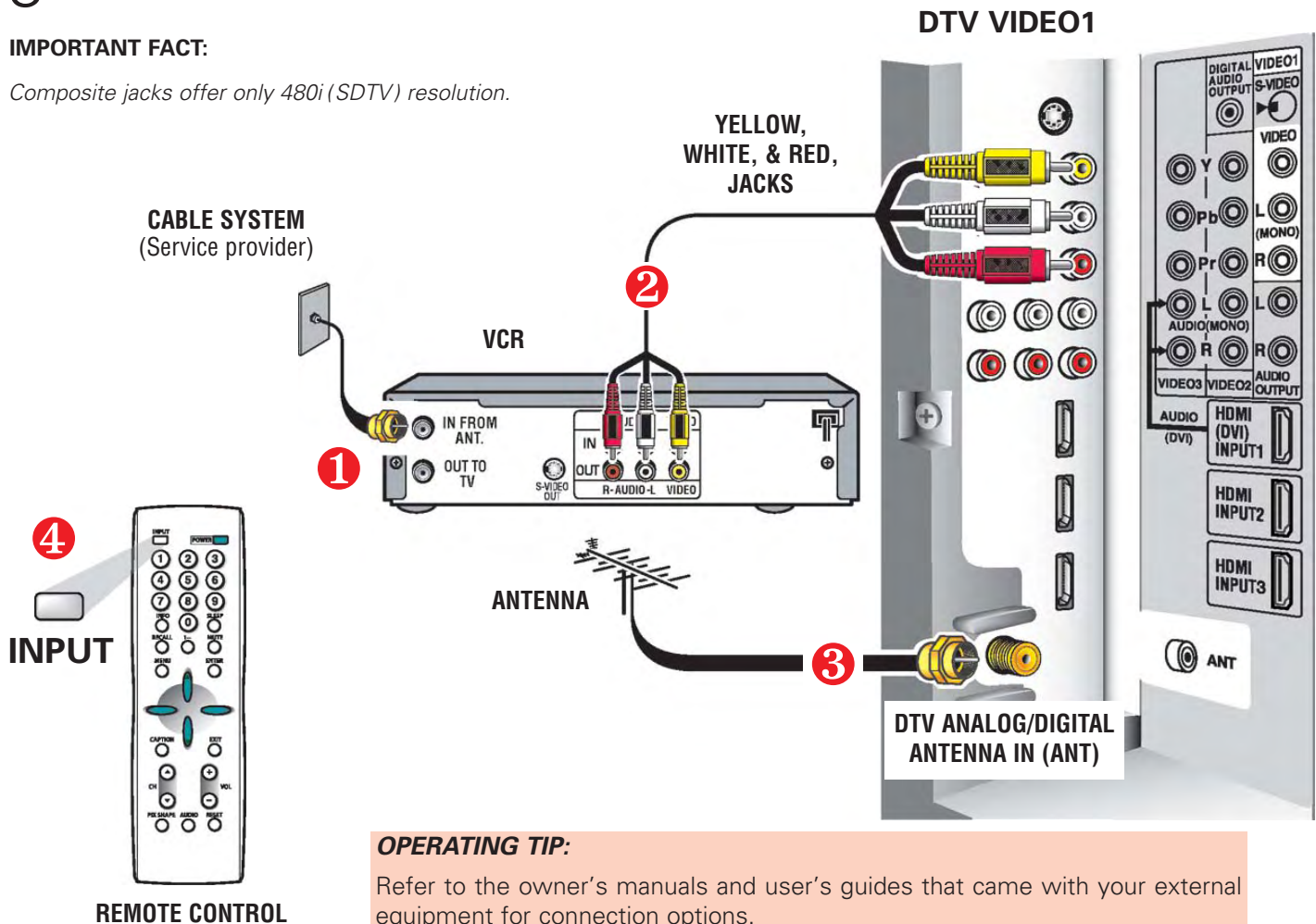

#### OPERATING TIP:

Refer to the owner's manuals and user's guides that came with your external equipment for connection options.

## HELP HINTS (PROBLEMS/SOLUTIONS)

#### SYMPTOM

"No Signal" will appear randomly on the screen when no signal is detected at the video jack.

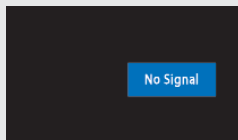

#### CHECK THESE CONDITIONS

- Check Audio/Video connections.
- Check external equipment connections.
- Check external equipment setting.

#### TRY THESE SOLUTIONS

- Press the **INPUT** key.
- Switch on external equipment.
- Set external equipment output connections to match input connections.

*If you continue to experience problems, please call toll free  
1-800-877-5032. We can Help!*

## VIDEO1 COMPOSITE (ANALOG) JACKS: *Connection Option 3*

### CONNECTING A DVD PLAYER TO THE DTV

- 1 Connect DVD to the TV S-Video In Jack.
- 2 Connect an Audio cable to the VIDEO1 White and Red AV jacks.
- 3 Press **INPUT** to select *Video1* to view the DVD program.

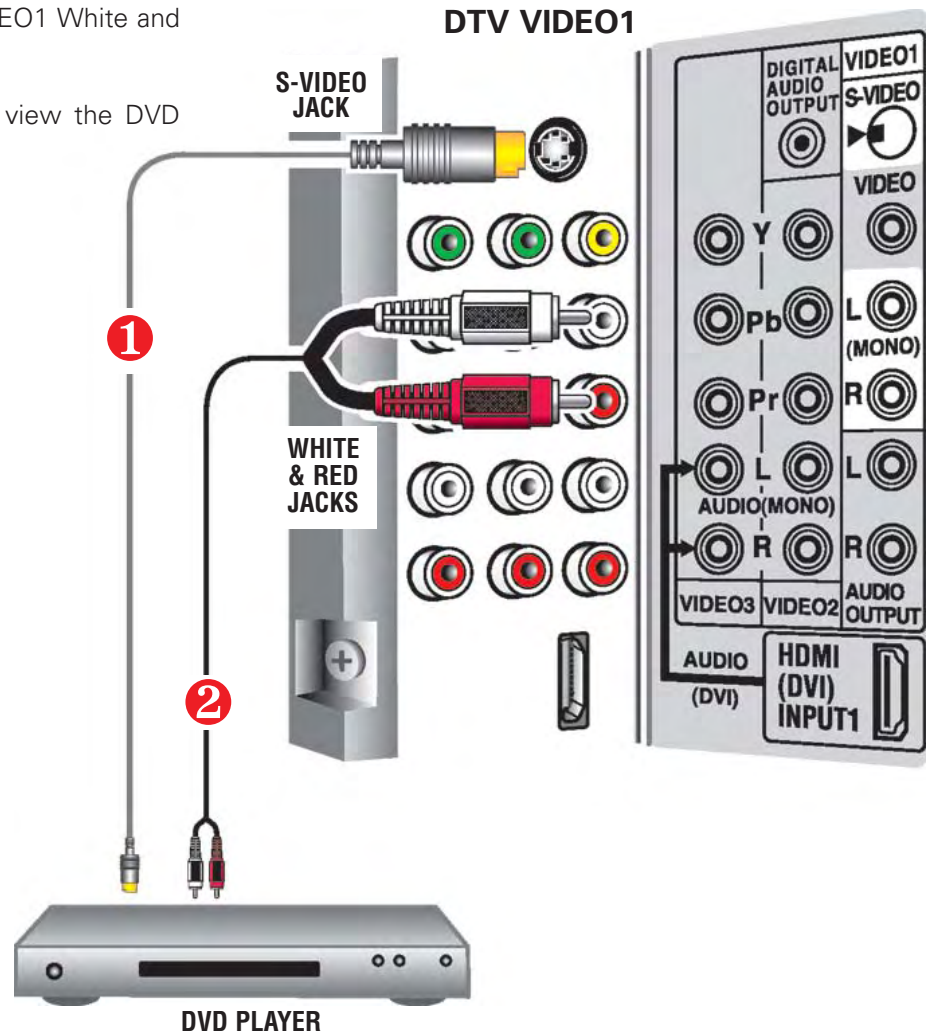
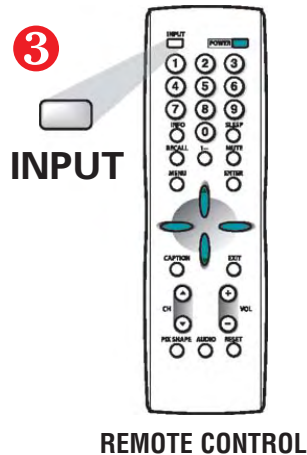

#### OPERATING TIP:

Refer to the owner's manuals and user's guides that came with your external equipment for connection options.

## HELP HINTS (PROBLEMS/SOLUTIONS)

### VIDEO1 jack connection

#### SYMPTOM

"No Signal" will appear randomly on the screen when no signal is detected at the video jack.

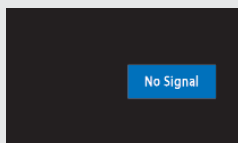

#### CHECK THESE CONDITIONS

- Check Audio/Video connections.
- Check external equipment connections.
- Check external equipment setting.

#### TRY THESE SOLUTIONS

- Press the **INPUT** key.
- Switch on external equipment.
- Set external equipment output connections to match input connections.

*If you continue to experience problems, please call toll free  
1-800-877-5032. We can Help!*

## DTV AUDIO OUT JACKS (DIGITAL & ANALOG)

### CONNECTING AN AV RECEIVER TO THE DTV

- 1 Connect a Coaxial Digital Audio cable from the DTV Digital Audio Output jack to a Coaxial Digital Audio In jack on an AV Receiver.
- 2 Connect an Audio cable from the DTV Audio Out jacks to Audio In jacks on the AV Receiver.

Note: *Dolby® Digital 5.1 audio is available at the Digital Audio Output only when received as part of a Digital Antenna signal.*

#### OPERATING TIP:

Refer to the owner's manual that came with your external equipment for connection options.

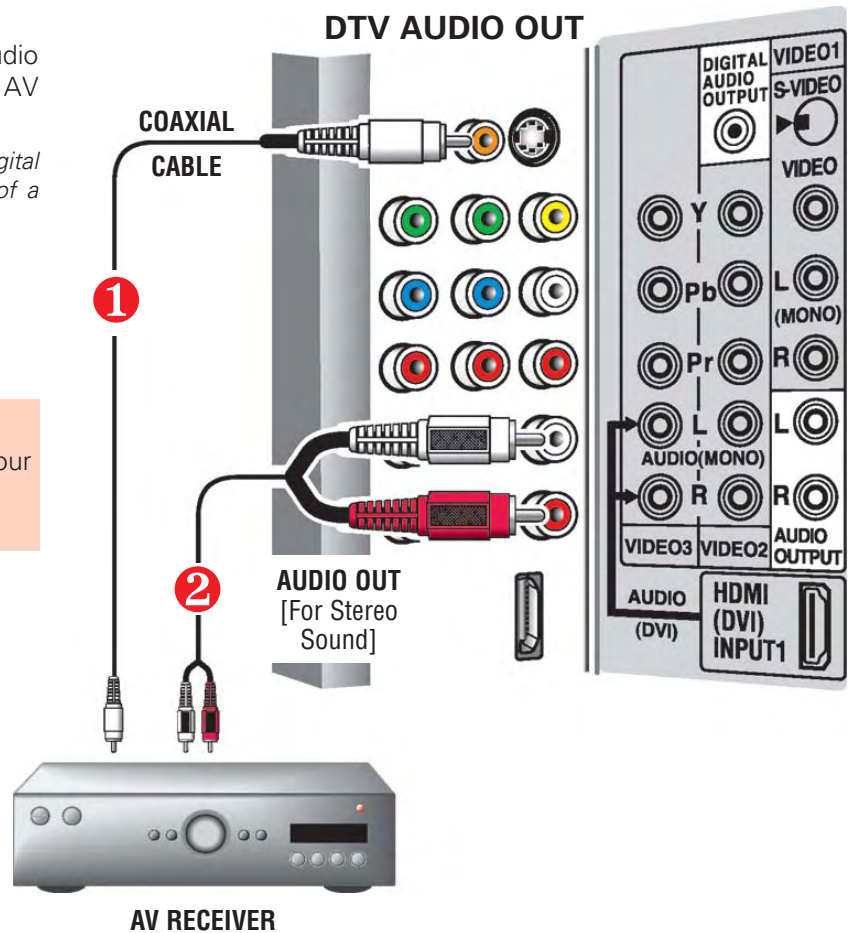

### HELP HINTS (PROBLEMS/SOLUTIONS)

#### SYMPTOM

No Sound or Poor Sound

#### CHECK THESE CONDITIONS

- Check external equipment connections.

#### TRY THESE SOLUTIONS

- Switch on external equipment.

*If you continue to experience problems, please call toll free  
1-800-877-5032. We can Help!*



## DTV AUDIO OUT JACKS (ANALOG)

### CONNECTING A STEREO AMPLIFIER TO THE DTV

1 Connect a Stereo Amplifier to the TV Audio Out jacks as shown.

Note: **Do not** connect external speakers directly to the DTV.

#### OPERATING TIP:

Refer to the owner's manual that came with your external equipment for connection options.

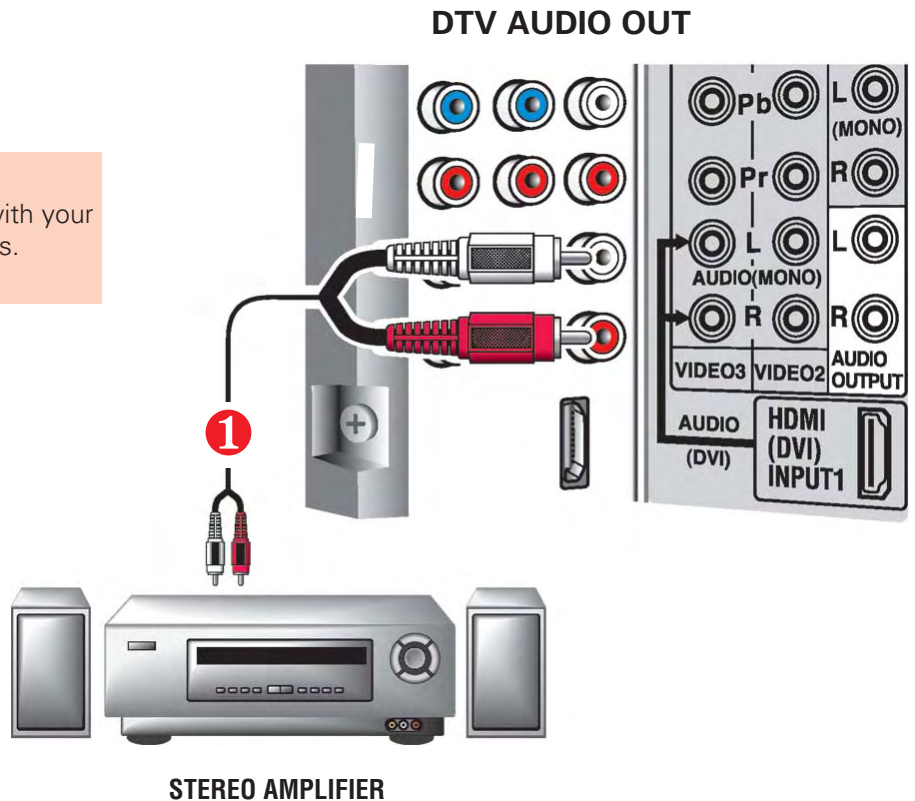

### HELP HINTS (PROBLEMS/SOLUTIONS)

#### SYMPTOM

No Sound or Poor Sound

#### CHECK THESE CONDITIONS

- Check external equipment connections.

#### TRY THESE SOLUTIONS

- Switch on external equipment.

*If you continue to experience problems, please call toll free  
1-800-877-5032. We can Help!*

# REMOTE CONTROL OPERATION

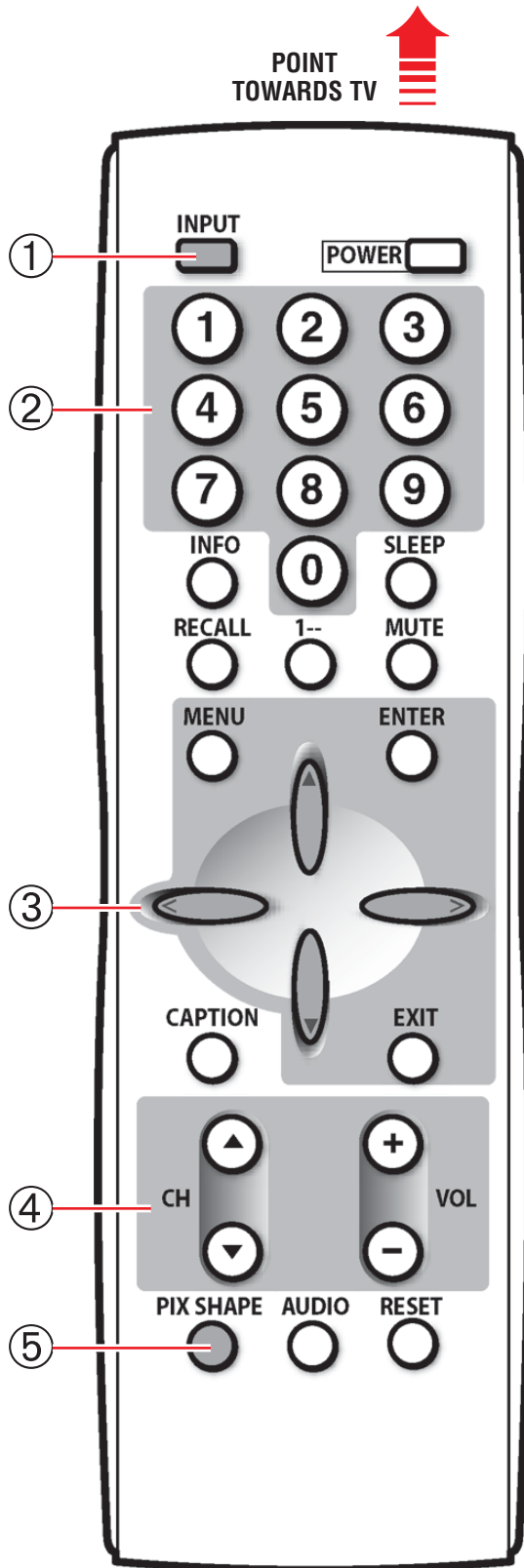

① **Input Key**—Press to select the program source to watch: Analog RF ➔ Digital RF ➔ Video 1 ➔ Video 2 ➔ Video 3 ➔ HDMI 1 ➔ HDMI 2 ➔ HDMI 3 ➔ Analog RF.

② **Number Keys**—Two keys must be pressed to select a direct channel. *Example:* Press **0** then **6** to select channel 6. (See item #5 below.)

*Note: Numerical direct channel selection works for either Analog or Digital channels in memory but not both at the same time.*

③ **Menu Navigational Keys:**

**Menu**—Press to display on-screen menu.

**Cursor ▲ (up) ▼ (down) keys**—Press these keys to move the cursor up and down within the menu.

**Cursor < (left) > (right) keys**—Press these keys to move the cursor left and right within the menu.

**Enter Key**—Press to select an option from the menu system, when required.

**Exit Key**—Press to exit from the menu system.

④ **Channel Scanning (CH ▲ ▼) Keys**—Press to scan through the channels in memory.

**Volume Keys**—Press **VOL - +** to adjust.

⑤ **PIX Shape Key**—Use to change the video display format. Available options depend on signal received and the broadcast's aspect ratio.

*Note: If you cannot display picture on a full screen. Check Aspect Ratio of broadcast. Then press the **PIX Shape key** to change setting.*

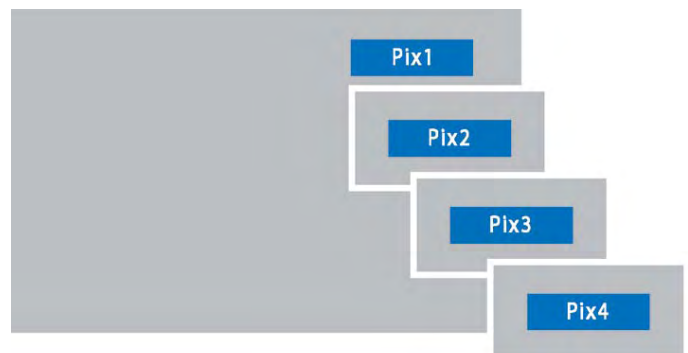

(CONTINUED ON NEXT PAGE.)

# REMOTE CONTROL OPERATION

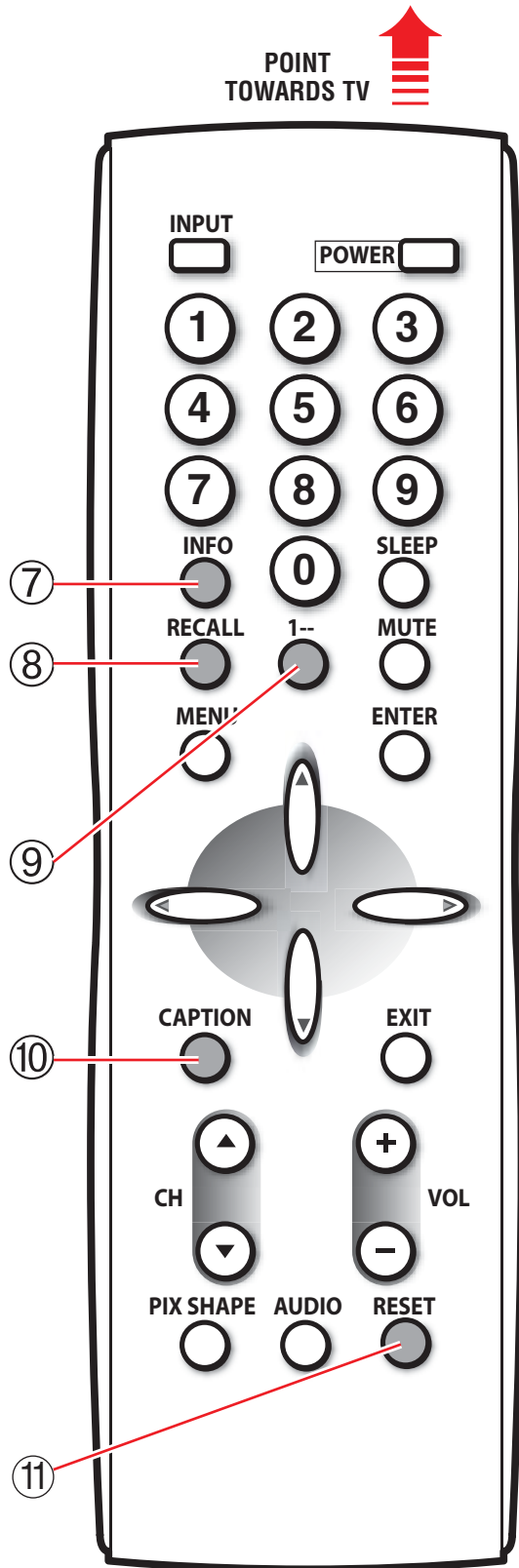

- ⑦ **Info Key**—Press to display the Digital and Analog Full Banner information. The banner contains the following: program title, station ID, program rating, signal strength, channel number, tuner ID, and audio information.

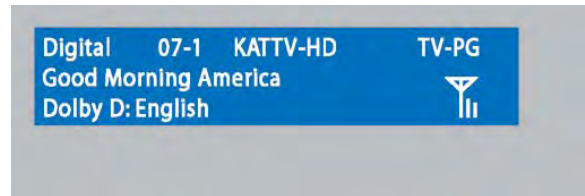

DIGITAL INFO BANNER



ANALOG INFO BANNER

- ⑧ **Recall Key**—Press to switch between the last two channels selected. The Recall key cannot toggle between a Digital channel and an Analog channel.
- ⑨ **1-- Key**—For Analog Cable channels above 100, press this key, then press the other two numbers.
- ⑩ **Caption Key**—Captioning is text information transmitted along with the picture and sound so it can be displayed on the TV screen.

Press CAPTION to select mode options: Digital CC1 ~ Digital CC6, or Analog CC1 ~ CC4, OFF, or QuikCap. (QuikCap switches captions on and off with the Mute function.) Digital Captions can be changed using the menu settings.

- ⑪ **Reset Key**—Press this key twice to restore factory settings. The TV will automatically start Channel Search and clear all customized settings.

*Note: Channel scan memory database list of digital and analog channels will be replaced. If desired, personal settings can be made again using the menu options.*

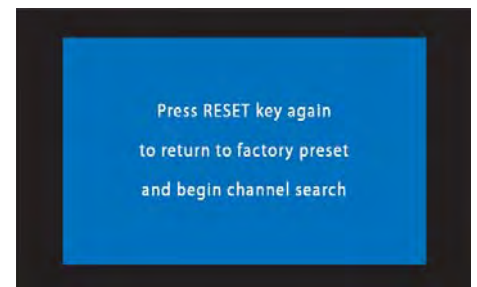

(CONTINUED ON NEXT PAGE.)

## REMOTE CONTROL OPERATION (Continued)

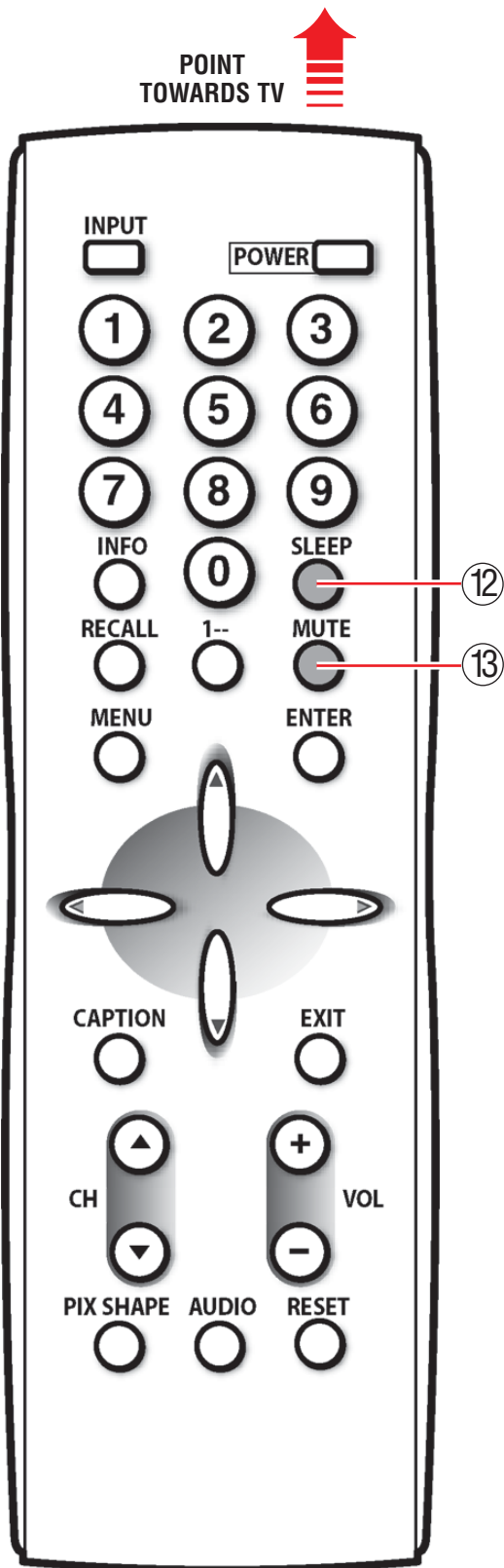

- ⑫ **Sleep Key**—Press this key then the “0” key to set the Sleep Off Timer. Time can be set in 30-minute increments up to 3 hours.

*Note: The Sleep Timer cancels when the TV is turned off or if a power failure occurs.*

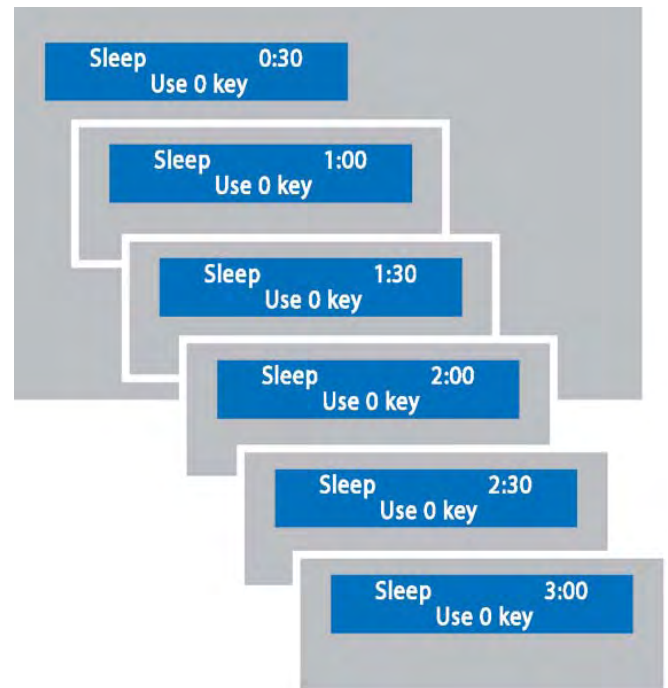

- ⑬ **Mute Key**—Press once to mute the sound. Press again to restore the sound.

(CONTINUED ON NEXT PAGE.)

## REMOTE CONTROL OPERATION (Continued)

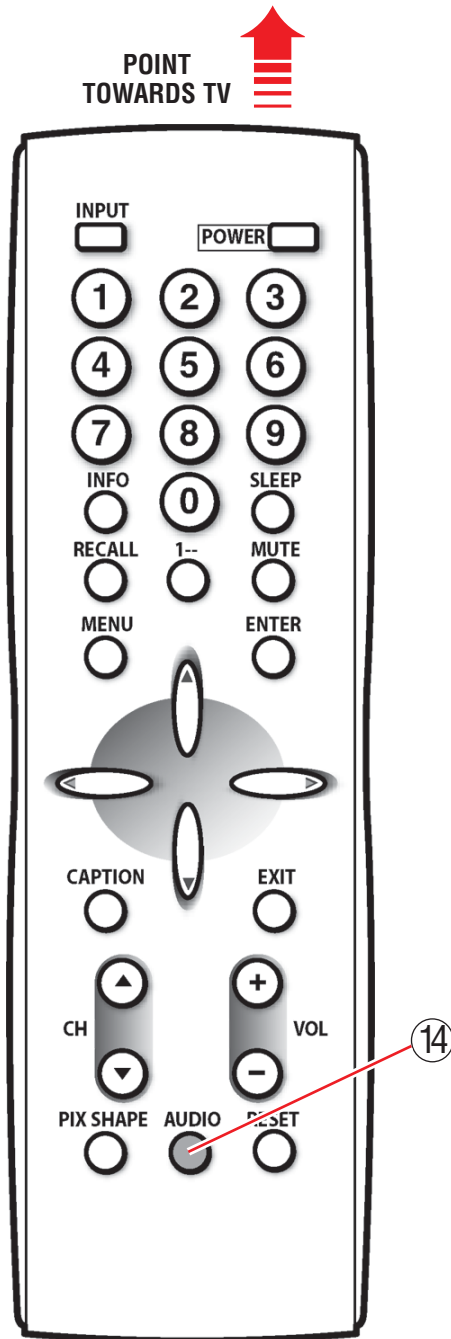

⑭ **Audio Key**—Press to select the desired audio mode (if available as part of the broadcast signal).

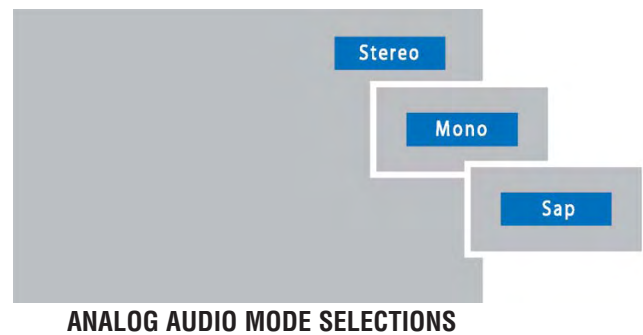
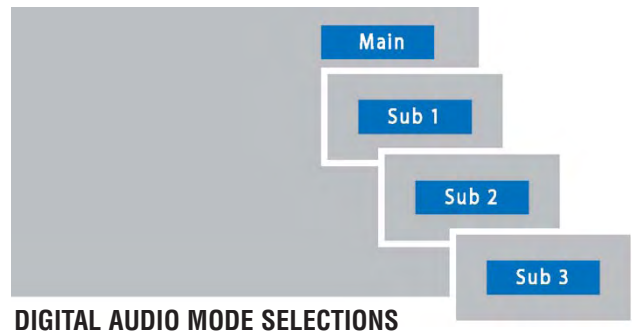

## HELP HINTS (PROBLEMS/SOLUTIONS)

### SYMPTOM

Remote Control will NOT work the TV.

### CHECK THESE CONDITIONS

- Check batteries.
- Check if TV is plugged in

### TRY THESE SOLUTIONS

- Replace batteries.
- Aim remote control at front of TV.

*If you continue to experience problems, please call toll free  
1-800-877-5032. We can Help!*

# DTV ADJUSTMENT AND SETUP

## HOW TO OPERATE THE MENU

- 1 Press the **MENU** key to display the Main menu.
- 2 Use the **CURSOR ▲▼** keys to highlight menu item.
- 3 Use the **CURSOR < >** keys to select or adjust menu item.
- 4 Press **ENTER** to activate setting, if needed.
- 5 When you have finished making adjustments, press the **EXIT** key to return to normal TV viewing.

*Note: For menu items that have sub menus, follow on-screen instructions to select and make adjustments.*

### OPERATING TIPS:

- Some Menu options are specific to Digital or Analog signals. To access these options, you must first tune the TV to a digital or Analog channel. Use the **INPUT** key on the remote to step through the input options. (See **INPUT** key on page 24.)
- **"Not Available"** will be displayed on the screen if an unavailable menu option is selected.

Not Available

### REMOTE CONTROL NAVIGATION KEYS

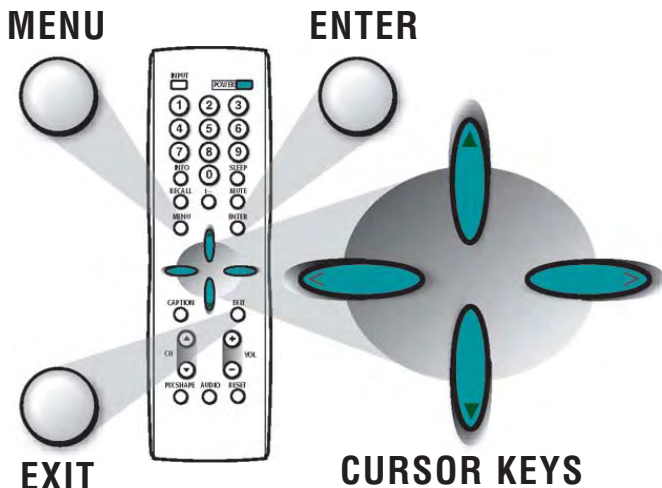

## MENU NAVIGATION MAP (Composite view)

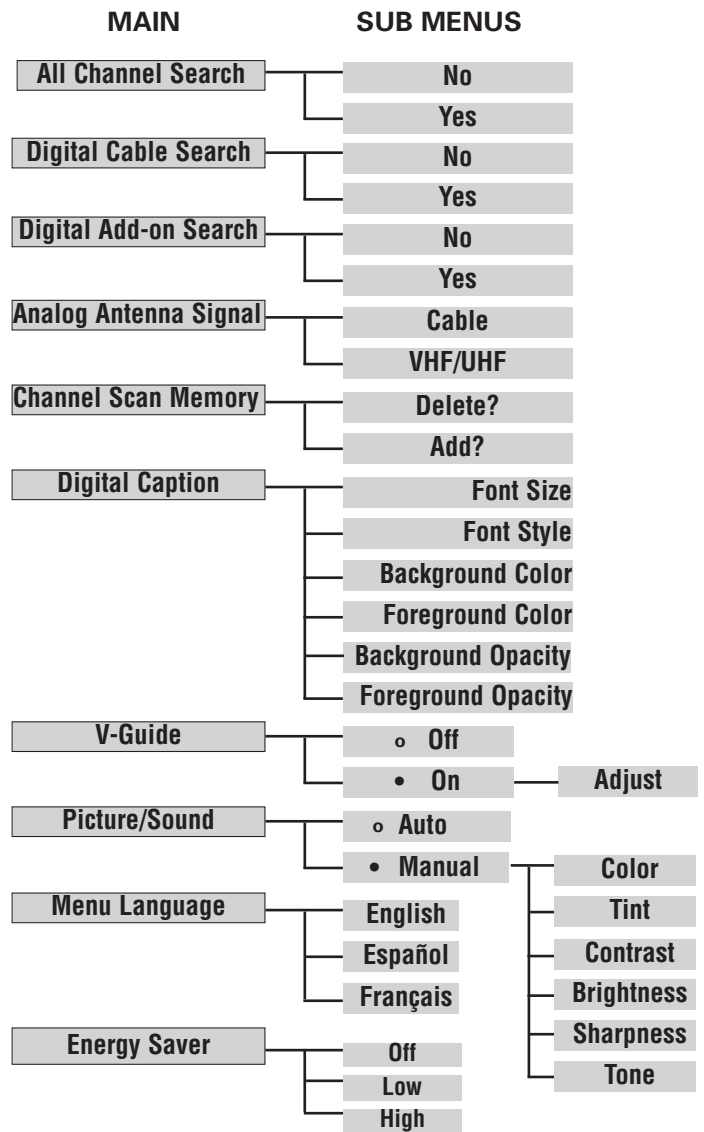

### MENU options:

Along with the on-screen instructions, each menu feature is explained in detail on the following pages.

## MENU OPTION—ALL CHANNEL SEARCH

The All Channel Search will search for off-air digital and analog channels, and analog cable channels. The DTV can receive cable or off-air channels, but not at the same time. *If after two searches the DTV still fails to detect any channels, the DTV will tune to Video1.*

- 1 Press the **MENU** key to display the Main menu.

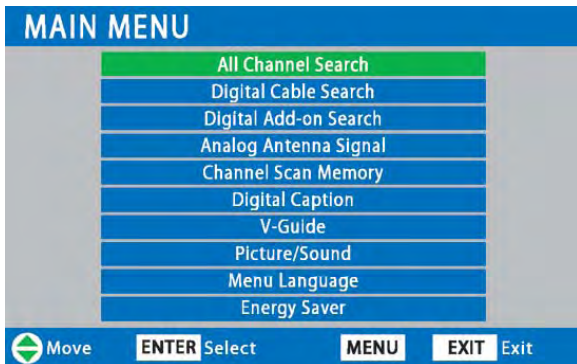

- 2 Use the **CURSOR** **▲▼** keys to highlight the *All Channel Search*. Press **ENTER**.

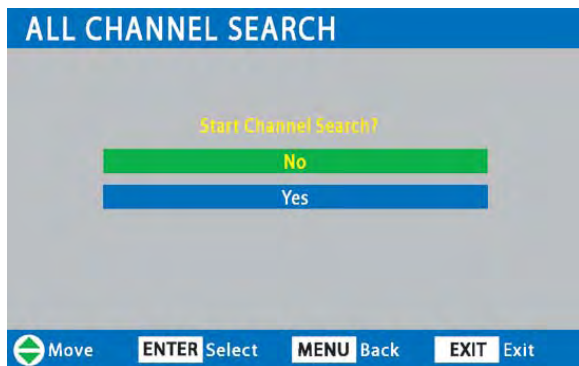

- 3 Use the **CURSOR** **▼** key to select Yes. Press **ENTER**.

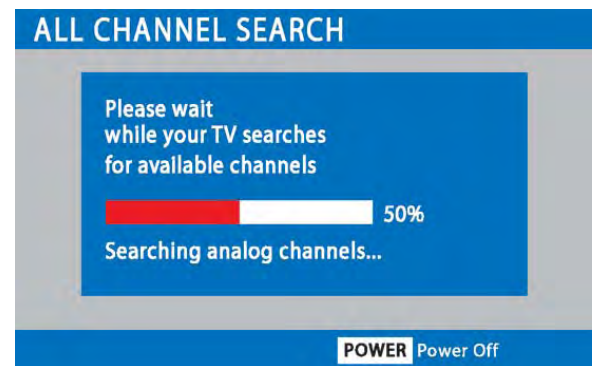
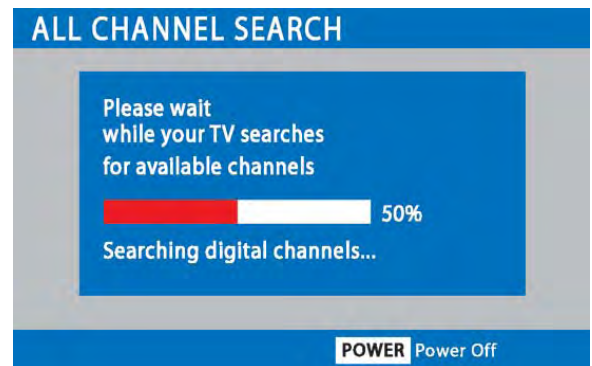
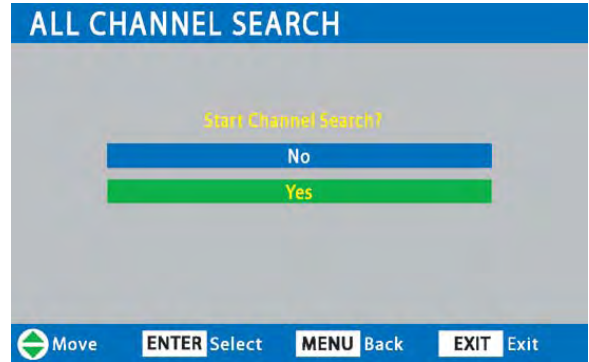

### OPERATING TIPS:

- DTV will select the correct Antenna mode for the type of signal connected automatically.
- If you move the DTV to a new location, press the **RESET** key twice after connecting the signal and turning on the DTV.

## MENU OPTION—DIGITAL CABLE SEARCH (Optional)

This DTV can receive unscrambled (ClearQAM) digital cable channels, when available. However, not all cable companies provide ClearQAM digital channels.

Digital Cable Search process will take about 10 minutes, please be patient.

- 1 Tune to a Digital Channel.
- 2 Press the **MENU** key to display the Main menu.
- 3 Use the **CURSOR ▲▼** keys to highlight the *Digital Cable Search*. Press **ENTER**.

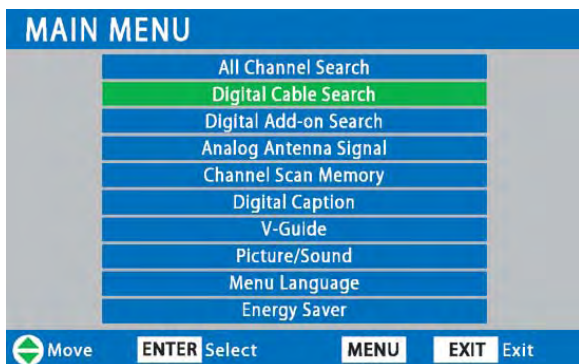

**IMPORTANT FACTS:** This DTV maintains only one database of digital channels. Therefore, when you search for ClearQAM digital cable channels, the database of antenna digital channels will be deleted. You will be able to receive only those ClearQAM channels your cable company provides.

To restore the antenna digital channel database, reconnect the antenna and use the menu system to perform an All Channel Search.

- 4 Use the **CURSOR ▼** key to select Yes. Press **ENTER**.

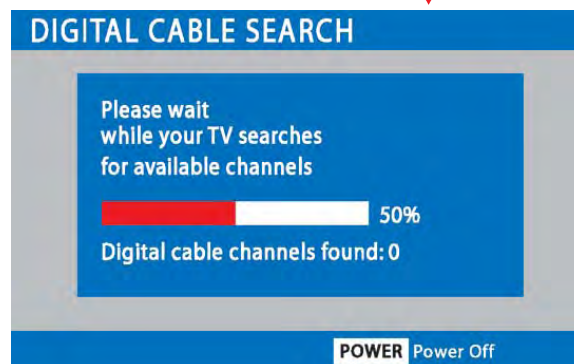
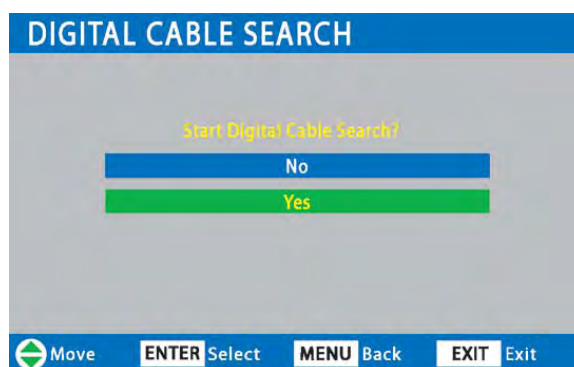
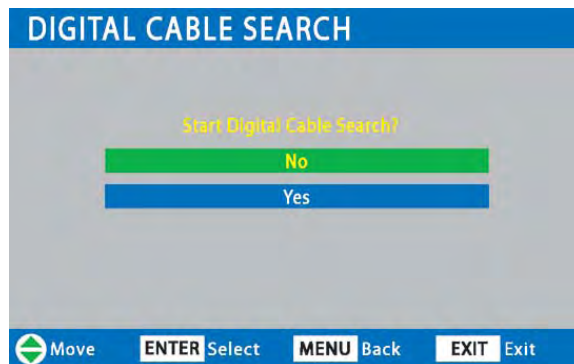

NOTE: After Channel Search is complete, the DTV will tune to the lowest Digital Cable channel.

## HELP HINTS (PROBLEMS/SOLUTIONS)

### SYMPTOM

Cannot select menu option, DIGITAL CABLE SEARCH.

### CHECK THESE CONDITIONS

- Did the word **Not Available** appear on-screen?
- DTV must be connected to a digital signal.

### TRY THESE SOLUTIONS

- The DTV is in the Analog mode, therefore, try performing another "All Channel Search."

*If you continue to experience problems, please call toll free  
1-800-877-5032. We can Help!*



## MENU OPTION—DIGITAL ADD-ON SEARCH

To add new digital channels to the existing antenna channel database, use Digital Add-on Search. Also, use this feature to add channels when broadcast towers are in multiple directions from your location.

For more info go to [www.antennaweb.org](http://www.antennaweb.org) and type in your zip code to obtain specific tower and antenna information. Then adjust your antenna and repeat the Digital Add-on Search.

- 1 Tune to a Digital Channel.
- 2 Press the **MENU** key to display the Main menu.
- 3 Use the **CURSOR** **▲▼** keys to highlight the *Digital Add-on Search*. Press **ENTER**.

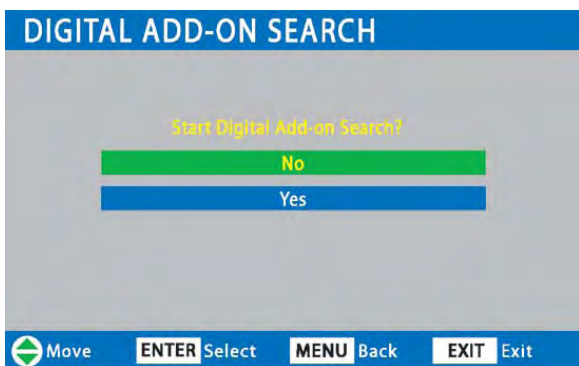
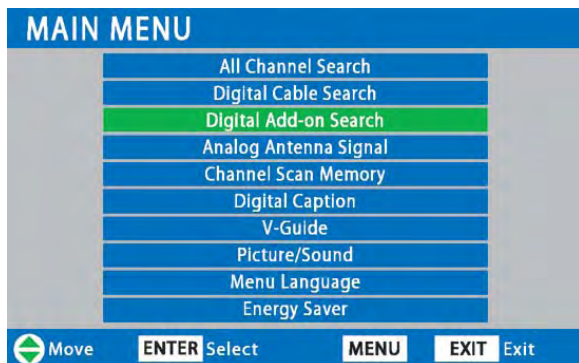

- 4 Use the **CURSOR** **▼** key to select Yes. Press **ENTER**.

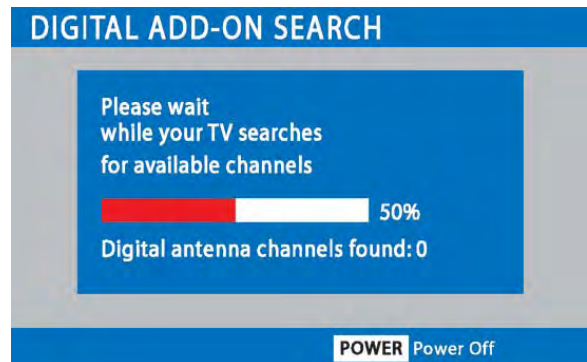
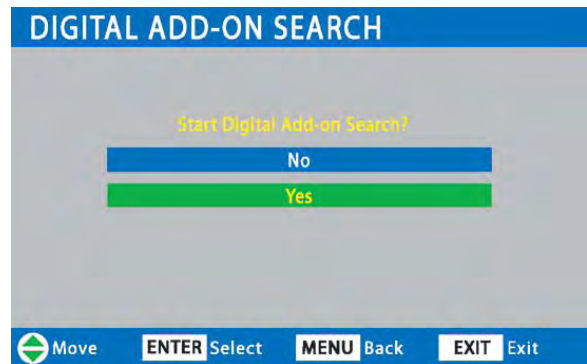

## HELP HINTS (PROBLEMS/SOLUTIONS)

### SYMPTOM

Cannot select menu option, DIGITAL ADD-ON SEARCH.

### CHECK THESE CONDITIONS

- Did the word **Not Available** appear on-screen?
- DTV must be connected to a digital signal.

### TRY THESE SOLUTIONS

- The DTV is in the Analog mode, therefore, try performing another "All Channel Search."

*If you continue to experience problems, please call toll free  
**1-800-877-5032. We can Help!***

## MENU OPTION—ANALOG ANTENNA SIGNAL (Optional)

Use this feature to switch between analog off-air channels and analog cable channels.

- 1 Tune to an Analog Channel.
- 2 Press the **MENU** key to display the Main menu.
- 3<sup>2</sup> Use the **CURSOR ▲▼** keys to highlight *Analog Antenna Signal*. Press **ENTER**.

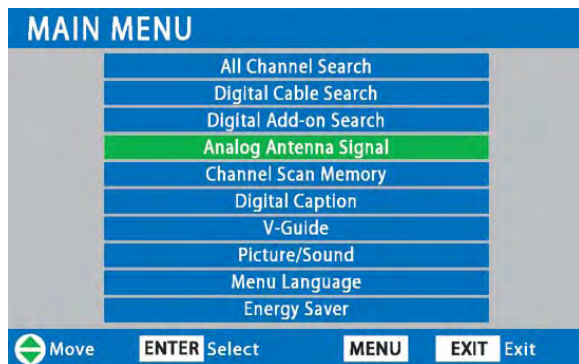

- 4 Use the **CURSOR ▲▼** keys to choose *Cable* or *VHF/UHF*. Press **ENTER**.

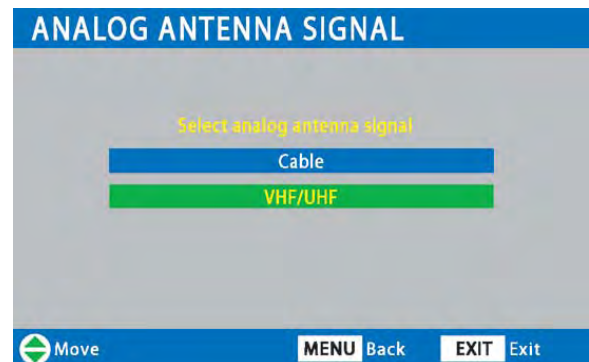
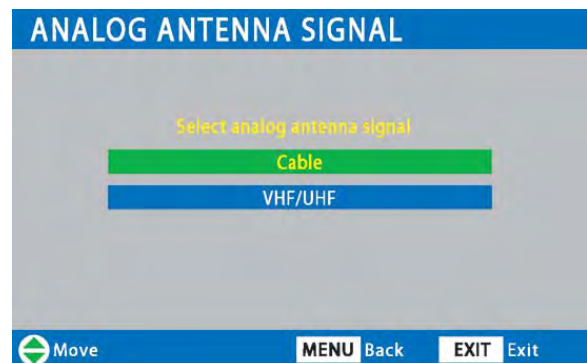

## HELP HINTS (PROBLEMS/SOLUTIONS)

<u>SYMPTOM</u>	<u>CHECK THESE CONDITIONS</u>	<u>TRY THESE SOLUTIONS</u>
Cannot select menu option, ANALOG ANTENNA SIGNAL.	<ul style="list-style-type: none"> <li>● Did the word <b>Not Available</b> appear on-screen?</li> </ul>	<ul style="list-style-type: none"> <li>● Press <b>INPUT</b> Key to select TV Analog mode.</li> </ul>
NO Cable channels above number 13	<ul style="list-style-type: none"> <li>● Cable Channel Indicator "C" should appear next to channel number.</li> </ul>	<ul style="list-style-type: none"> <li>● Switch Menu option—Analog Antenna Signal selection to CABLE.</li> </ul>
NO UHF; VHF Channels OK.	<ul style="list-style-type: none"> <li>● Cable Channel Indicator <b>C</b> should <b>not</b> appear next to the channel number.</li> </ul>	<ul style="list-style-type: none"> <li>● Switch Menu option—Analog antenna signal to VHF/UHF.</li> </ul>

*If you continue to experience problems, please call toll free  
1-800-877-5032. We can Help!*

## MENU OPTION—CHANNEL SCAN MEMORY

### DELETING ANALOG OR DIGITAL CHANNELS FROM MEMORY

Channel Scan Memory is a list of active channels that you can scan through using the **Channel Scan CH ▲** (up) **CH ▼** (down) keys. This list can be customized by deleting and/or adding channels.

- 1** Press the **MENU** key to display the Main menu.
- 2** Use the **CURSOR ▲▼** keys to highlight *Channel Scan Memory*. Press **ENTER**.

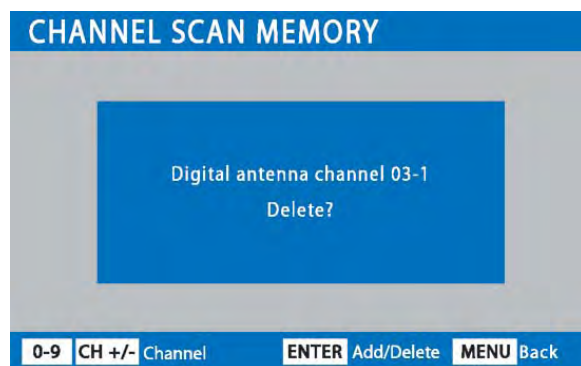
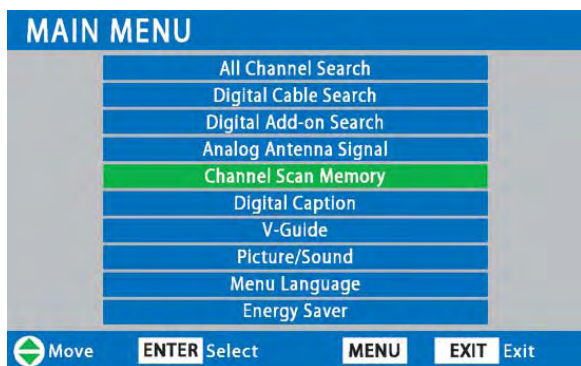

- 3** Use the **CHANNEL (CH ▲▼)** keys or numerical **0 ~ 9** keys to select desired channel.
- 4** Press the **ENTER** key to delete the channel. The display will change to "deleted."

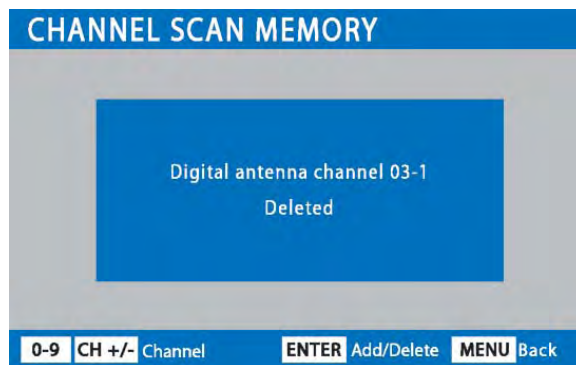

After 3 seconds the TV screen will display "Add?"

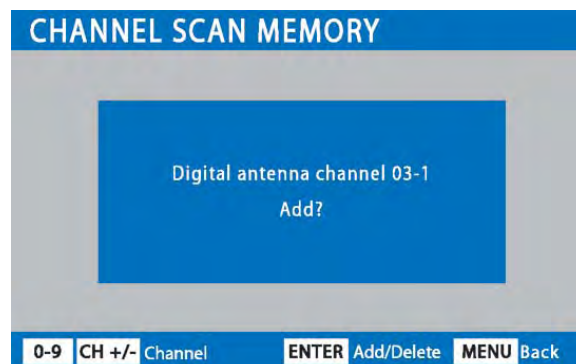

#### **OPERATING TIPS:**

- When a digital channel is deleted, all of that channel's sub-channels are deleted as well.
- Only previously deleted digital channels can be added back to the Channel Scan Memory.

## HELP HINTS (PROBLEMS/SOLUTIONS)

### **SYMPTOM**

Cannot select or scan some channels.

### **CHECK THESE CONDITIONS**

- Channels may be removed from memory.
- Check antenna connections.
- NO digital signal being broadcast.
- Weak Signal.
- V-Guide is set to block programming.

### **TRY THESE SOLUTIONS**

- Select Channel Scan memory and manually add channels or start an "All Channel Search."
- Turn antenna, install signal booster.
- Set V-Guide to "Off" or press **RESET** key to clear all settings and restart channel search.

*If you continue to experience problems, please call toll free  
**1-800-877-5032. We can Help!***

## MENU OPTION—CHANNEL SCAN MEMORY

### ADDING DIGITAL OR ANALOG CHANNELS TO MEMORY

Channel Scan Memory is a list of active channels that you can scan through using the **Channel Scan CH ▲** (up) **CH ▼** (down) keys. This list can be customized by deleting and/or adding channels.

- 1 Press the **MENU** key to display the Main menu.
- 2 Use the **CURSOR ▲▼** keys to highlight *Channel Scan Memory*. Press **ENTER**.

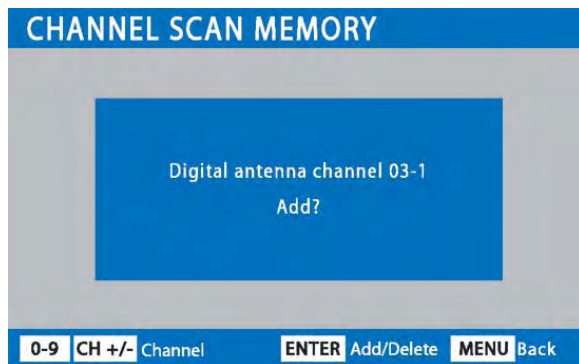
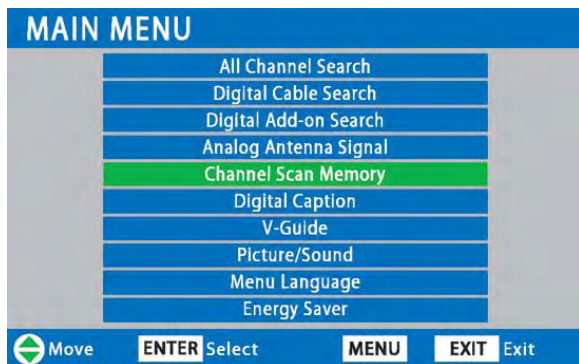

- 3 Use the **CHANNEL (CH ▲▼)** keys or numerical **0 ~ 9** keys to select desired channel.
- 4 Press the **ENTER** key to add the channel. The display will change to "added."

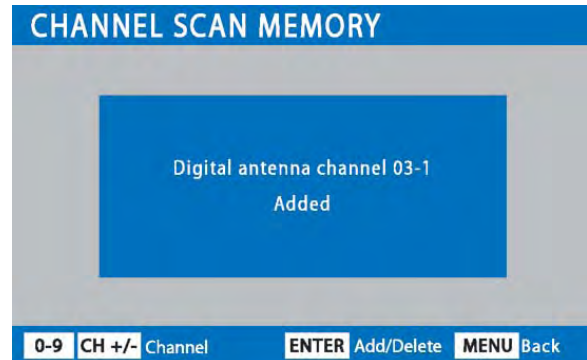

After 3 seconds the TV screen will display "Delete?"

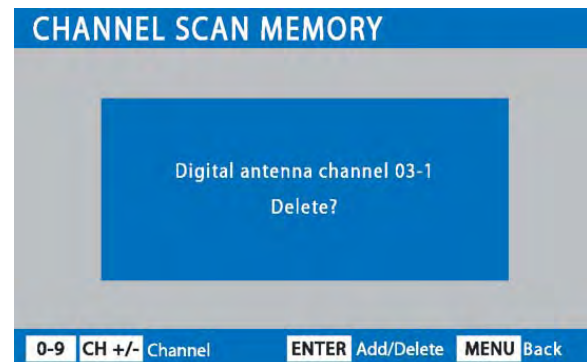

#### OPERATING TIP:

- If one digital sub-channel is added back to the Channel Scan Memory list, all of that channel's sub-channels will be added back.

## HELP HINTS (PROBLEMS/SOLUTIONS)

### SYMPTOM

Cannot select or scan some channels.

### CHECK THESE CONDITIONS

- Channels may be removed from memory.
- Check antenna connections.
- NO digital signal being broadcast.
- Weak Signal.
- V-Guide is set to block programming.

### TRY THESE SOLUTIONS

- Select Channel Scan memory and manually add channels or start an "All Channel Search."
- Turn antenna, install signal booster.
- Set V-Guide to "Off" or press **RESET** key to clear all settings and restart channel search.

*If you continue to experience problems, please call toll free  
1-800-877-5032. We can Help!*

## MENU OPTION—DIGITAL CAPTION

Closed-Captioning is text information transmitted along with the picture and sound. Turning Captioning ON causes the DTV to open these captions (digital or analog) and superimpose them on the screen. (Local broadcasters decide which caption signals to transmit.)

Digital Captions can be changed using the menu settings as shown.

- 1** Tune to a Digital Channel.
- 2** Press the **MENU** key to display the Main menu.

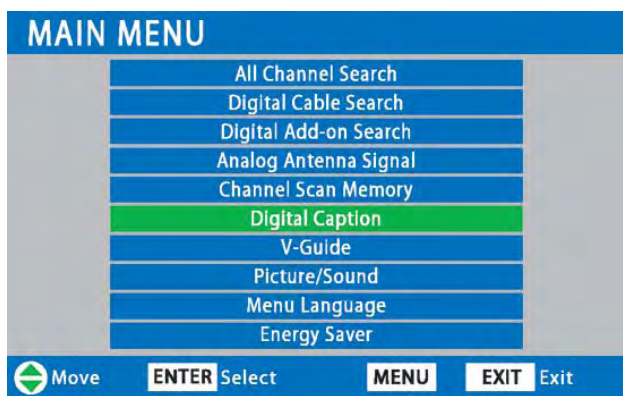

- 3** Use the **CURSOR ▲▼** keys to highlight *Digital Caption*. Press **ENTER**.
- 4** Use the **CURSOR ▲▼** keys to highlight an option. Press **ENTER**.

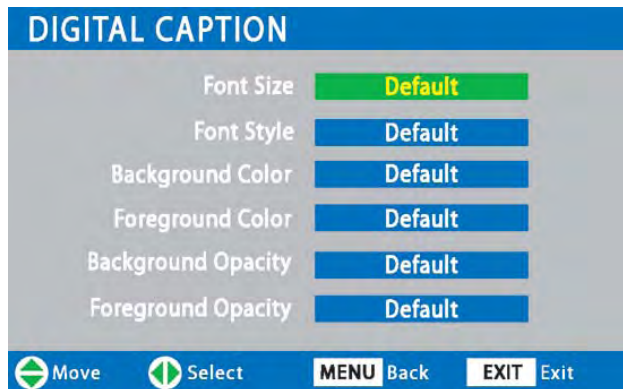

- 5** Use the **CURSOR <>** keys to select the desired effect.



### OPERATING TIPS:

- If Background Opacity is set to transparent, captions may be difficult to see.
- Only true EIA 708B Digital Closed-Captions are affected by all of these settings.

### QUIKCAP OPERATION

QuikCap turns captioning on and off with the Mute function. Press the **MUTE** key on the remote control to block the TV sound; the captions display automatically, if available. Press the **MUTE** key again to restore the sound. Captions will disappear.

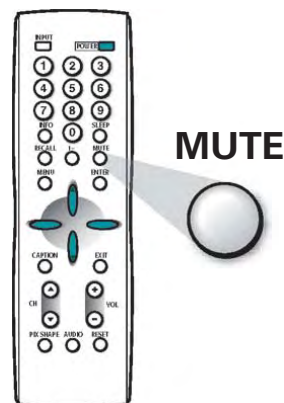
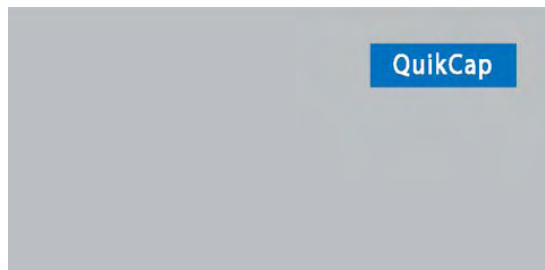

(CONTINUED ON NEXT PAGE.)

## MENU OPTION—DIGITAL CAPTION (Continued)

### TO VIEW CAPTIONS

Press the CAPTION key to select caption modes.

**Digital modes:** Digital CC1 through Digital CC6, QuikCap, and Off.

**Analog modes:** CC1 through CC4, QuikCap, and Off.

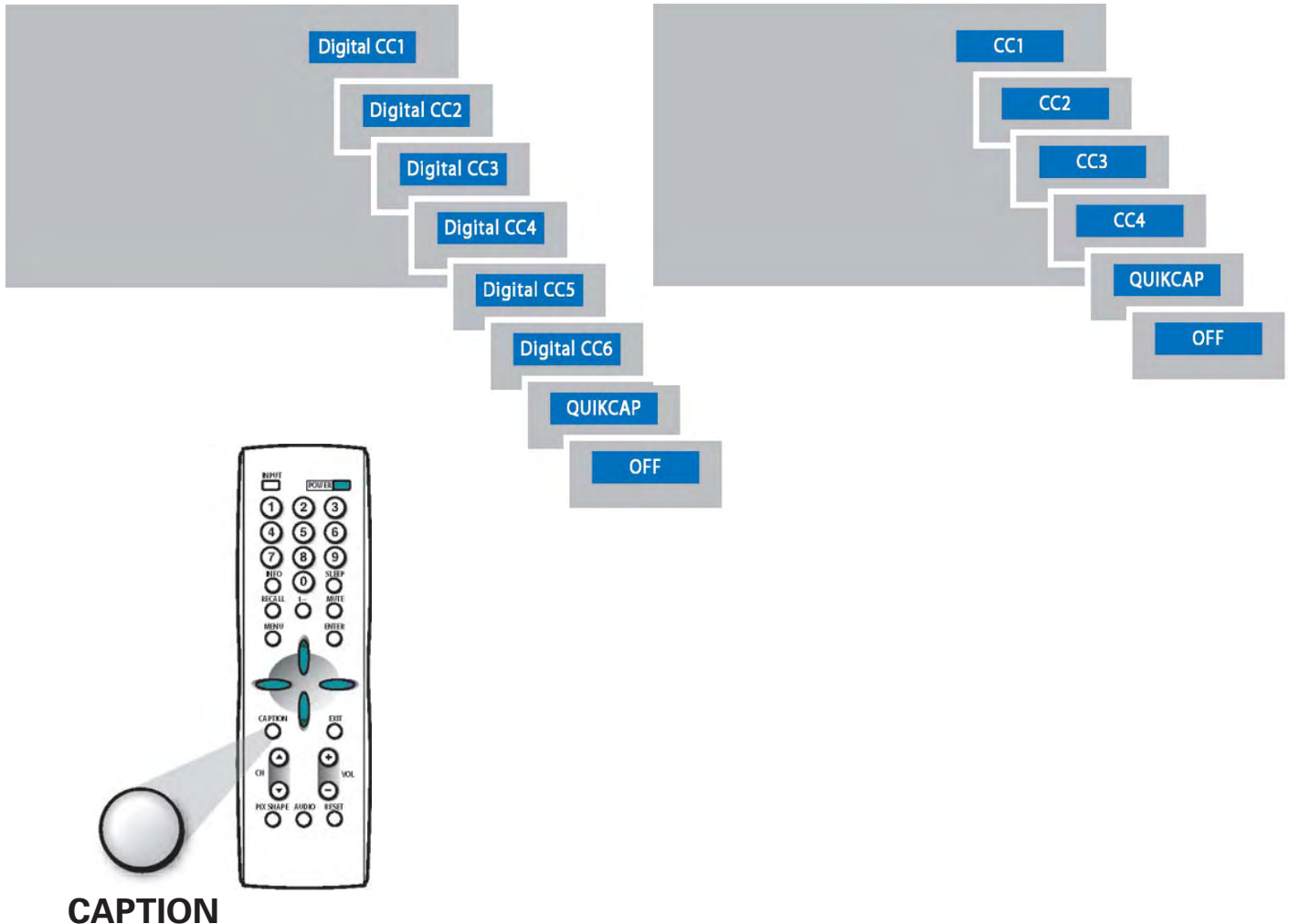

### HELP HINTS (PROBLEMS/SOLUTIONS)

SYMPTOM	CHECK THESE CONDITIONS	TRY THESE SOLUTIONS
NO Captioning	<ul style="list-style-type: none"> <li>● Check if station is broadcasting a Closed-Caption signal.</li> </ul>	<ul style="list-style-type: none"> <li>● Press <b>CAPTION</b> key to select Captioning.</li> </ul>
Cannot customize Caption.	<ul style="list-style-type: none"> <li>● Digital Caption signal not broadcast.</li> </ul>	<ul style="list-style-type: none"> <li>● Press <b>CAPTION</b> key to select Analog captioning.</li> </ul>

*If you continue to experience problems, please call toll free  
1-800-877-5032. We can Help!*

## MENU OPTION—V-GUIDE (PARENTAL CONTROL)

**NOTE: THIS FEATURE IS DESIGNED TO COMPLY WITH THE UNITED STATES OF AMERICA'S FCC V-CHIP REGULATIONS. THEREFORE, IT MAY NOT FUNCTION WITH BROADCASTS THAT ORIGINATE IN OTHER COUNTRIES.**

Use this feature to automatically block programs with content you deem as inappropriate for children to view.

This Sanyo television is equipped with an electronic V-Chip to interpret MPAA (Motion Picture Association of America) and TV Parental Guidelines rating codes. When these codes are detected, the DTV will automatically display or block the program, depending upon choices you make when setting up the V-Guide system.

### TO BLOCK MOVIE OR TV PROGRAM

- 1 Press the **MENU** key to display the Main menu.
- 2 Use the **CURSOR** **▲▼** keys to highlight *V-Guide*. Press **ENTER**.

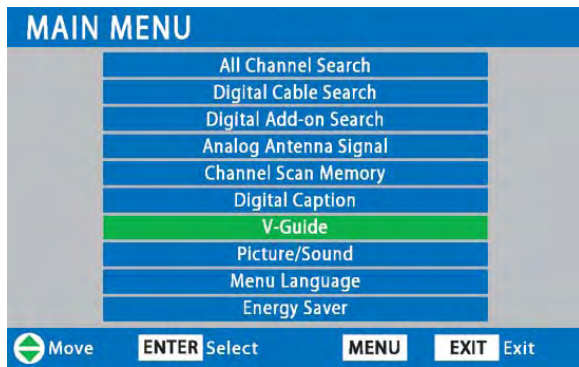

- 3 Use the **CURSOR** **▲▼** keys to select *ON*. Press **ENTER**.

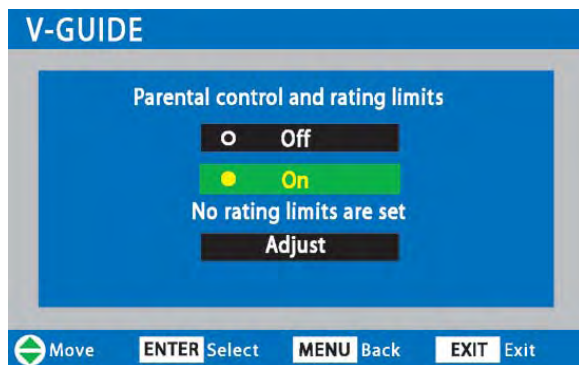

### TO SETUP V-GUIDE RATINGS

- 4 Use the **CURSOR** **▼** to select *Adjust*. Press **ENTER**.

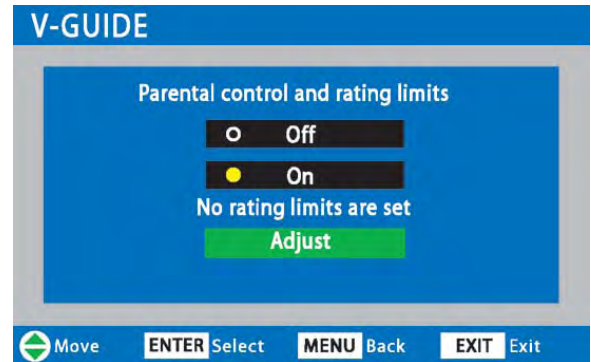

- 5 Press **CURSOR** **▲▼** and **<>** keys to select *MOVIE*, *TV Rating*, or *Content Ratings*. (A green square will appear beside the selected item.)

Content ratings are represented by the initials: FV (fantasy violence), L (adult language), S (sexual situations), V (violence), and D (suggestive dialog).

- 6 Press the **ENTER** key to Block or Unblock selected option. A lock will appear beside the selected rating option indicating it is blocked.

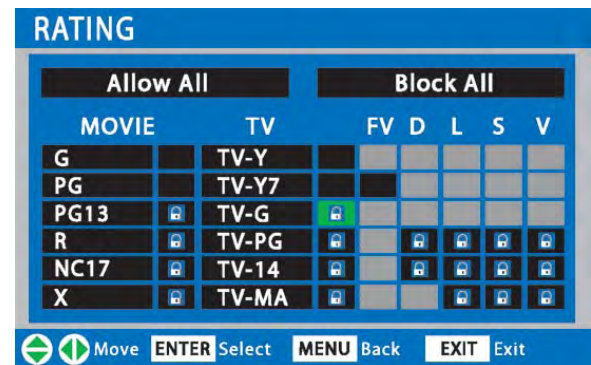

*(CONTINUED ON NEXT PAGE.)*

## MENU OPTION—V-GUIDE (PARENTAL CONTROL) *Continued*

### ON-SCREEN VIEW OF BLOCKED TV PROGRAM

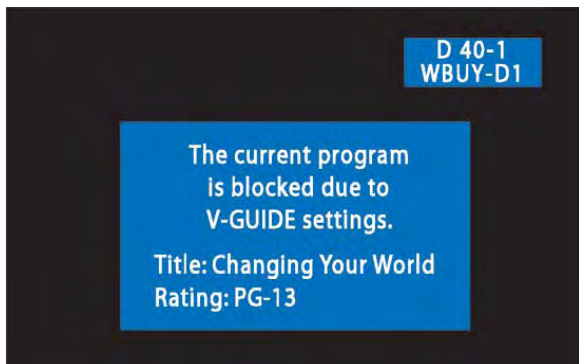

### TO TEMPORARILY UNBLOCK MOVIE OR TV PROGRAM

- 1 Press the **MENU** key to display the Main menu.
- 2 Use the **CURSOR** **▲▼** keys to highlight *V-Guide*. Press **ENTER**.
- 3 Use the **CURSOR** **▲▼** keys to select *OFF*. Press **ENTER**.

This will temporarily set V-Guide to *OFF*. When V-Guide is reset to *ON* (follow steps 1~2), the DTV will automatically revert to previously selected block ratings.

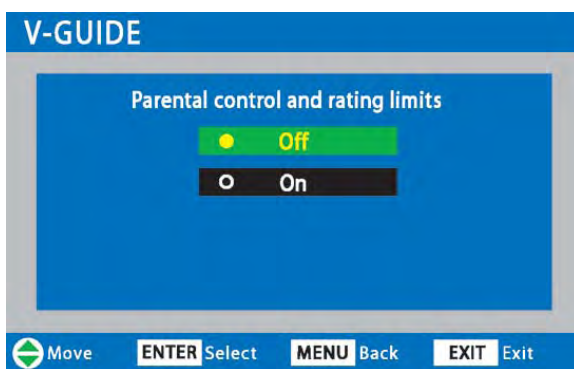

### TO UNBLOCK ALL MOVIE OR ALL TV RATING

- 1 Press the **MENU** key to display the Main menu.
- 2 Use the **CURSOR** **▲▼** keys to highlight *V-Guide*. Press **ENTER**.
- 3 Press **ENTER** to select *Adjust*.
- 4 Highlight the “Allow All” option using the **CURSOR** **▲▼** and **< >** keys, if needed. Press **ENTER**.

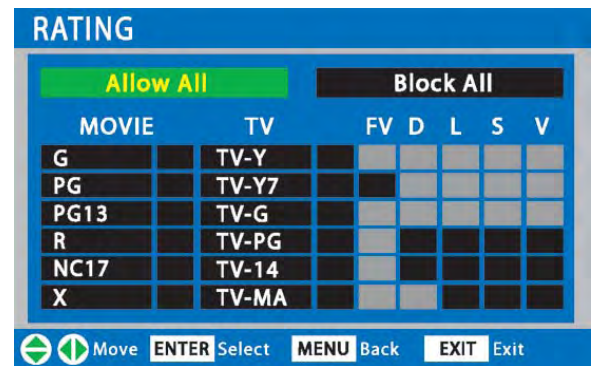

#### OPERATING TIPS:

- You can block portions of a DTV rating by choosing one or more of the Content ratings (D, L, S, and V). By blocking just the L and S content ratings of TV-14, for example, TV-14 rated programs with a D and/or V content rating could still be viewed.
- V-Guide limits on programming received via the Analog antenna input, Digital antenna input, Video 1 input, and any 480i signals received through the Component jacks can be controlled by this DTV.
- V-Guide Limits on digital programming received through the component jacks are controlled by the external equipment connected to these jacks. Refer to your external device's owner's manual for instructions on setting V-Guide Limits.

**(CONTINUED ON NEXT PAGE.)**



## MENU OPTION—V-GUIDE (PARENTAL CONTROL) *Continued*

### TV RATINGS (AGE/CONTENT-BASED)



**ALL CHILDREN**—Program is designed to be appropriate for children ages 2-6.



**DIRECTED TO OLDER CHILDREN**—Program is designed for children 7 and above. Material may include mild fantasy violence (FV) or comedic violence.



**GENERAL AUDIENCE**—Program suitable for all ages. Contain little or no violence, no strong language or sexual dialogue or situations.



**PARENTAL GUIDANCE SUGGESTED**—Program contains material that may be unsuitable for younger children. Material contains one or more for the following: moderate violence (V), some sexual situations (S), infrequent coarse language (L), or some suggestive dialogue (D).



**PARENTS STRONGLY CAUTIONED**—Some material is unsuitable for children under 14 years of age. Parents are strongly urged to use caution against letting children under age 14 watch unattended. Material contains intense violence (V), intense sexual situations (S), strong coarse language (L), or intensely suggestive dialogue (D).



**MATURE AUDIENCE ONLY**—Program is designed to be viewed by adults and therefore may be unsuitable for children under 17 years of age.

### MPAA MOVIE RATINGS (AGE-BASED)

**G GENERAL AUDIENCES**—All ages admitted.

**PG PARENTAL GUIDANCE SUGGESTED**—Some material may not be suitable for children.

**PG-13 PARENTAL GUIDANCE CAUTIONED**—Some material may be inappropriate for children under 13.

**R RESTRICTED**—Under 17 requires accompanying parent or adult guardian

**NC-17 NO ONE 17 AND UNDER ADMITTED**

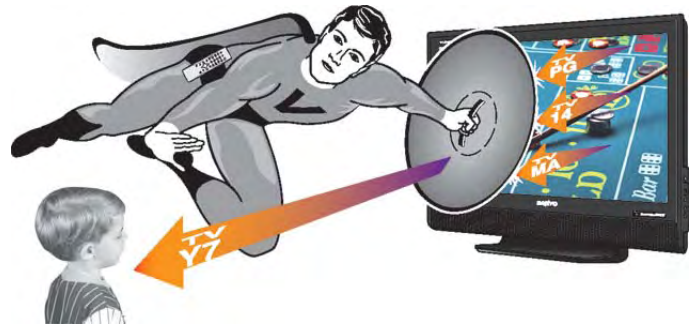

When codes are being transmitted and received, and V-Guide is set to ON, the V-Chip blocks programming according to the settings you choose.

## MENU OPTION—PICTURE/SOUND

- 1 Press the **MENU** key to display the Main menu.
- 2 Use the **CURSOR** **▲▼** keys to highlight *Picture/Sound*. Press **ENTER**.
- 3 Use the **CURSOR** **▲▼** keys to highlight *Auto* (factory preset settings) or *Manual*. Press **ENTER**.

### MANUAL ADJUSTMENTS

- 4 Use the **CURSOR** **▲▼** keys to select the option you want to adjust.
- 5 Then use the **CURSOR** **< >** keys to make an adjustment.

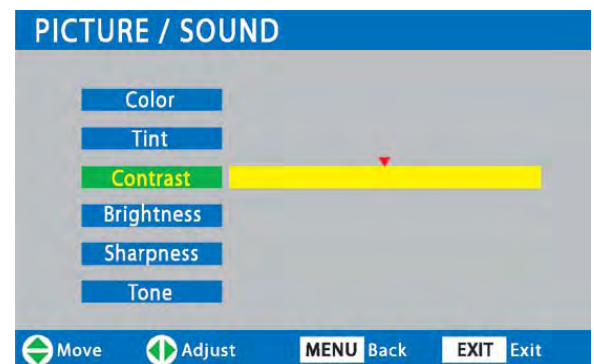
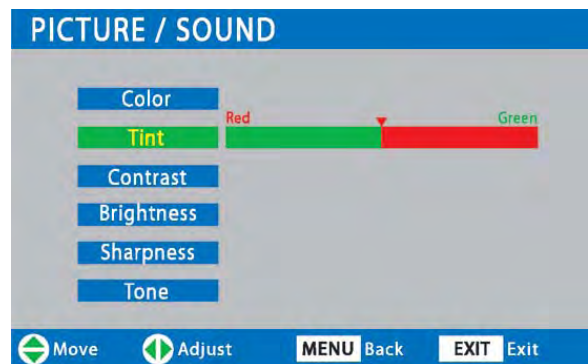
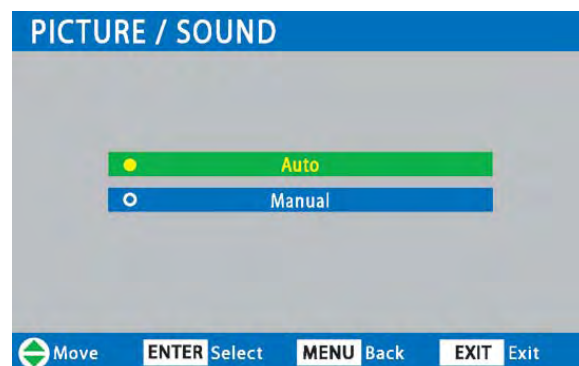
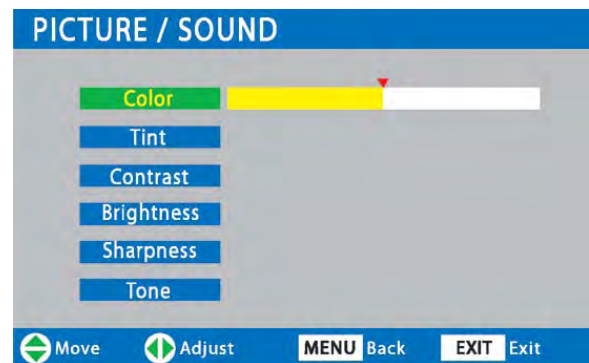
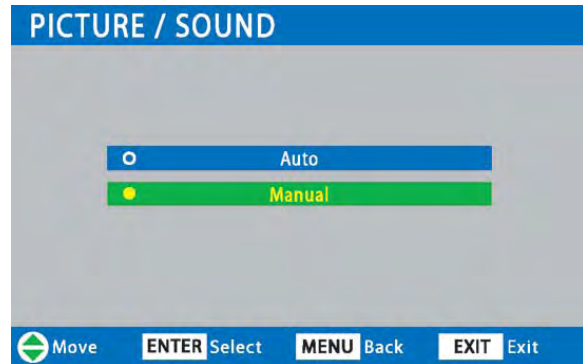
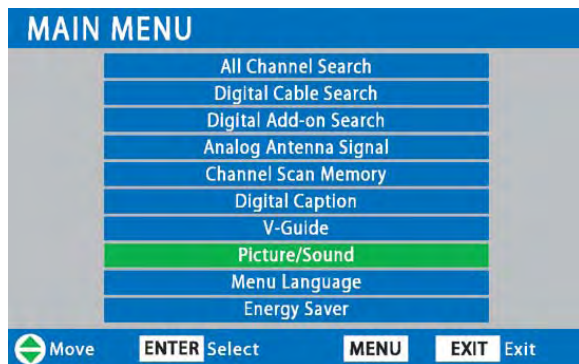

(CONTINUED ON NEXT PAGE.)

## MENU OPTION—PICTURE/SOUND (Continued)

### MANUAL ADJUSTMENTS (CONTINUED)

**4** Use the **CURSOR ▲▼** keys to select the option you want to adjust.

**5** Then use the **CURSOR < >** keys to make an adjustment.

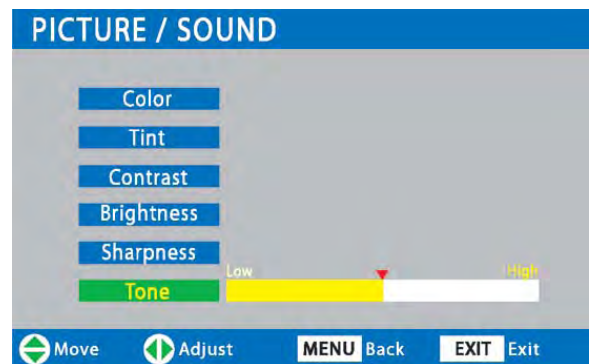
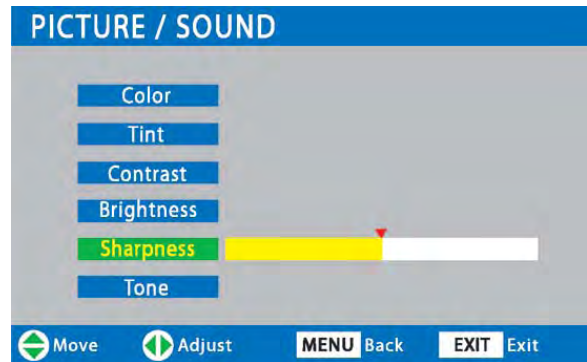
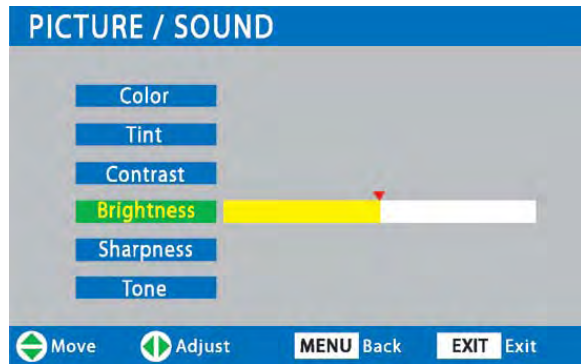

## HELP HINTS (PROBLEMS/SOLUTIONS)

<u>SYMPTOM</u>	<u>CHECK THESE CONDITIONS</u>	<u>TRY THESE SOLUTIONS</u>
No picture, sound (Digital Picture)	<ul style="list-style-type: none"> <li>● Weak Signal.</li> <li>● Check antenna/external connections.</li> <li>● May be station trouble, NO signal broadcast.</li> <li>● MUTE function may be on.</li> </ul>	<ul style="list-style-type: none"> <li>● Adjust antenna. Install booster</li> <li>● Press the <b>RESET</b> key to restart channel search.</li> <li>● Try a different channel.</li> <li>● Adjust Volume.</li> </ul>
Poor Picture/Sound (watching Analog)	<ul style="list-style-type: none"> <li>● Check if program is in color.</li> <li>● Check antenna/external connections.</li> <li>● Color or Tint misadjusted.</li> <li>● May be station trouble.</li> <li>● May be MUTE function is on.</li> </ul>	<ul style="list-style-type: none"> <li>● Try a different channel.</li> <li>● Adjust antenna.</li> <li>● Press the <b>RESET</b> key to restart channel search.</li> </ul>

*If you continue to experience problems, please call toll free  
**1-800-877-5032. We can Help!***

## MENU OPTION—MENU LANGUAGE

- 1 Press the **MENU** key to display the Main menu.
- 2 Use the **CURSOR ▲▼** keys to highlight *Menu Language*. Press **ENTER**.
- 3 Use the **CURSOR ▲▼** keys to select *English*, *Español*, or *Français*.

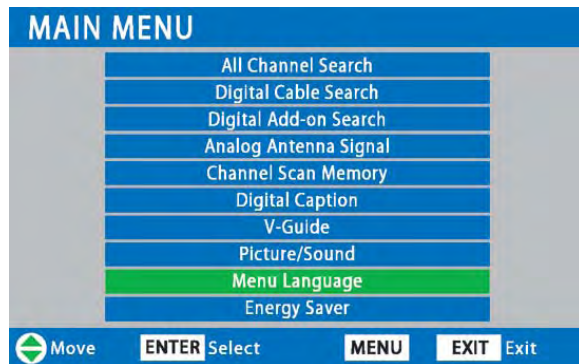

## MENU OPTION—ENERGY (POWER) SAVER

This power saving feature reduces the brightness level. The power saving function options:

- OFF – the feature is off and the power consumption is normal.
- LOW – power saving level is low and the brightness level is lower than normal.
- HIGH – power saving level is high and the brightness is set to the lowest level.

**1** Press the **MENU** key to display the Main menu.

**2** Use the **CURSOR ▲▼** keys to highlight *Energy Saver*. Press **ENTER**.

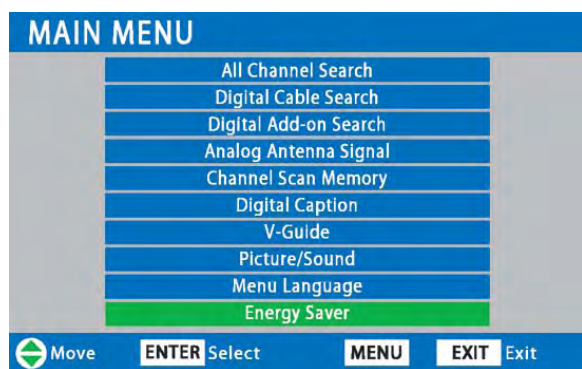

**3** Use the **CURSOR ▲▼** keys to highlight desired option.

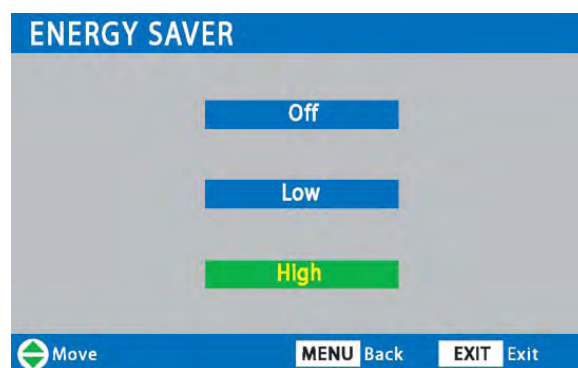
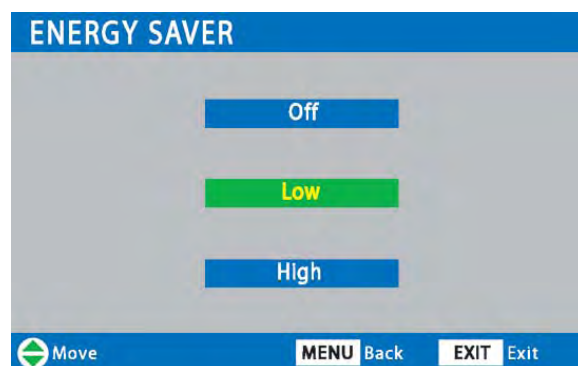
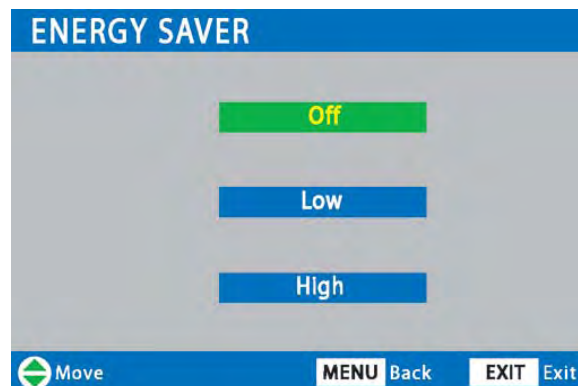

## GLOSSARY OF TERMS

**Analog**—Commonly refers to the current NTSC transmission standard for televisions.

**Aspect Ratio**—The ratio of the width to the height of a TV screen independent of the screen size (x units wide by x units high). Analog is 4:3; Digital can be 4:3 or 16:9 (also called wide screen).

**ATSC**—Advanced Television Systems Committee

**AV Jacks**—Audio Video Jacks

**Bandwidth**—The range of frequencies assigned to a broadcast channel. A TV channel is 6 MHz wide.

**Component Jacks (Y Pb Pr)**—Green, Blue, and Red video jacks that accept 480i, 480p, 720p, and 1080i signals. By separating the Green (Y), Blue (Pb), and Red (Pr) video signal components, clearer, more-defined images that exceed the performance of S-Video and Composite video jacks are achieved.

**Composite Jacks**—White, Red, and Yellow AV jacks. The White and Red jacks carry the Left and Right audio signals while the Yellow jack carries the composite video signal.

**Dolby® Digital (Formally known as Dolby AC-3)**—A 5.1 channel (Front L/R, Rear L/R, Center, and Bass) surround sound audio standard for digital television.

**Downconverting**—The removal of pixels. Frame rate and/or scanning format may also change. Broadcasters may use this process to make room in their bandwidth for additional services, such as, sub-channels.

**DTV (Digital Television)**—Comprises four elements, HDTV, EDTV, SDTV, and Multicasting.

**DVI**—Digital Visual Interface. A pure digital video interface that can pass standard-definition and high-definition video signals. It supports the HDCP copy protection standard, allowing transmission of copy-protected digital content.

**EDTV**—Enhanced-Definition TV (480p)

**HDMI**—High-Definition Multimedia Interface. An all digital audio/video interface that accepts uncompressed video signals for the very best picture possible. It supports the HDCP copy protection standard, allowing transmission of copy-protected digital content. The signal can also include Dolby® Digital or PCM audio, when available.

**HDTV**—High-Definition TV (720p, 1080i, & 1080p)

**Input / Output Jacks**—Used to receive (input) and send (output) signals from one device to another. Such as, from a DVD player (Output) to the TV (Input).

**Interlaced Scanning**—The process of scanning two fields of video then combining (interlacing) them to make one frame of video (or one complete image).

**Letter Box**—This term is used to describe a 16:9 ratio image being displayed on a 4:3 ratio display device. Black bands appear at the top and bottom of the screen.

**MPEG2**—A compression scheme for moving images and audio. It was developed by the Motion Picture Experts Group. This makes HDTV and multicasting possible.

**Multicasting**—The dividing of a station's broadcast signal into sub-channels of programming or data services. The resolution of the main channel must be reduced to make room for sub-channels.

**NTSC**—National Television Systems Committee

**Pillar Boxing**—This term is used to describe a 4:3 ratio image being displayed on a 16:9 ratio display device. Black bars (or pillars) appear at the sides of the screen.

**Pixel**—Picture Element

**Progressive Scanning**—The process of scanning lines sequentially. One scan produces one frame of video (or one complete image).

**Set-Top Box (STB)**—A device that receives and converts signals for display on a television screen (can be digital or analog). Many digital STBs have cable and over-the-air tuners.

**SDTV**—Standard-Definition TV (480i)

**Signal**—The picture, sound, and data transmitted or received through the air to an antenna, over a Cable TV system, from a Satellite to a dish and receiver, or between external components of an Audio/Video system.

**Simulcast**—Simultaneously broadcasting the same program on two or more channels. This is required by the FCC during the transition from analog to digital. Simulcasting is scheduled to end and only digital broadcasts will continue after February 17, 2009.

**S-Video Jack**—A round 4-pin jack that accepts separated luminance and chroma signals from a DVD player, Super VHS VCR, or similar analog device. The resolution of this input exceeds that of a composite video input (yellow connector), but is lesser than the resolution of component inputs (Y Pb Pr).

**Terrestrial**—An over-the-air broadcast to an antenna.

**Upconverting**—A process of converting original analog programming to digital for DTV broadcasting. Pixels may be duplicated and inserted between existing pixels to simulate HDTV. This does not increase the resolution. The resolution of an image is set during the recording process. It cannot be increased through conversion processes.

**Wide Screen**—Used to describe a 16:9 or greater aspect ratio. 16:9 is the standard aspect ratio for HDTV digital displays. Movies screens are often slightly wider.

## FREQUENTLY ASKED QUESTIONS (FAQ)

### 1. What channel do I put my television on to watch a DVD player?

To determine where the DVD player is connected, turn the DVD player and TV on and set the TV on channel 3. Then press the INPUT key on the remote control to scroll through the signal inputs to locate the DVD player startup screen.

### 2. I am not receiving all of my VHF and UHF channels or cable channels?

Make sure an antenna or your cable service is connected to the "ANT" Terminal. If there is a VCR connected, make sure it is turned off. Press the **RESET** key on the remote two times to begin an automatic channel search.

### 3. How do you turn the caption on and off?

To turn captioning on or off, press and release the **CAPTION** key on the remote until the desired caption mode appears (CC1 and Digital CC1 are used most commonly).

### 4. I'm connected to a satellite system. How do I get my television to go to channel 73?

Turn on the satellite receiver then press the **RESET** key on the remote twice to begin a channel search. If after the search no satellite channels appear. Tune the TV to channel 3. Press the **MENU** key on the remote and select "Analog Antenna Signal." Use the **CURSOR** keys to select CABLE. Press the **EXIT** key, then press in channel 73.

### 5. How do I get a full picture on the screen?

If you are connected to a Cable box or Satellite receiver, bring up the box menus and select 4:3 as the screen aspect ratio. Then press the **PIX SHAPE** key on the television remote control for the desired screen shape.

### 6. Is my remote universal?

No, this remote control is designed to operate a Sanyo television only.

### 7. When I do a channel search some of my digital channels disappear. What is wrong?

Many digital stations are not on-the-air 24 hours a day. After doing the initial channel search, always use the menu system to perform a "Digital Add-on Search" to add new digital channels, so that stations not on-the-air during the search will not be erased.

### 8. There is no picture, sound is ok?

Check appropriate video connection to make sure it corresponds to the audio connection being used. If the sound is associated with component jacks on a DVD player, it may be necessary to access the DVD menu to select the component outputs or S-Video output.

### 9. There is no sound, picture is clear?

If you are connecting your television through the Composite jacks (Video1), S-Video jack (Video1), or Component jacks (Video2 or Video3) the matching audio jacks must also be connected.

### 10. The picture is not as clear as it should be. Am I using the best quality connection?

*Picture quality is classified as follows:*

Analog RF signal (off-air or cable) . . . . .	Basic
Video1 (Composite – yellow) . . . . .	Good
Video1 (S-Video) . . . . .	Better
Video2 (Component – green, blue, red) . . . . .	Exceptional
Video3 (Component – green, blue, red) . . . . .	Exceptional
Digital RF (off-air, when the signal is HD) . . . . .	Ultimate
HDMI 1 / 2 / 3 . . . . .	Ultimate

### 11. How do I register my television warranty?

No registration is necessary, just hold on to your sales receipt. We will warranty the television from the date on the receipt.

### 12. Where is the code for a Sanyo television to program into my universal remote?

You must obtain the code from the manufacturer of the remote control you want to program. Refer to the remote's owner's manual.

### 13. When I adjust the volume on the television why does the volume level on the surround sound system remain steady?

The audio output jacks are set to a fixed level and do not vary with the television volume. The volume control on the surround sound system must be used.

### 14. My digital channel number doesn't match the station number.

On some digital channels the channel number displayed on the television will be different than the channel ID number. This is determined by the digital package broadcasted from the local station through the digital signal.

### 15. What is the recommended method for cleaning the cabinet and screen?

Clean the cabinet with a soft-dry cloth. Clean the screen using a damp-soft-cotton cloth.



## ONE-YEAR LIMITED PARTS AND LABOR WARRANTY

THIS LIMITED PARTS AND LABOR WARRANTY IS VALID ONLY ON SANYO TELEVISIONS PURCHASED AND USED IN THE UNITED STATES OF AMERICA, CANADA, AND PUERTO RICO, EXCLUDING ALL OTHER U.S. TERRITORIES AND PROTECTORATES. THIS LIMITED WARRANTY APPLIES ONLY TO THE ORIGINAL RETAIL PURCHASER, AND DOES NOT APPLY TO PRODUCTS USED FOR INDUSTRIAL OR COMMERCIAL PURPOSES.

### WARRANTY APPLICATION

**FOR ONE YEAR** from the date of original retail purchase Sanyo Manufacturing Corporation (SMC) warrants this TV to be free from manufacturing defects in materials and workmanship under normal use and conditions for parts and labor.

For the **FIRST 90 DAYS** from the date of original retail purchase, Sanyo Manufacturing Corporation will replace any defective TV via exchange at the retailer. **To ensure proper warranty application, keep the original-dated-sales receipt for evidence of purchase. Return the defective TV to the retailer along with the receipt and the included accessories, such as the remote control. The defective TV will be exchanged for the same model, or a replacement model of equal value, if necessary. Replacement model will be contingent on availability and at the sole discretion of Sanyo Manufacturing Corporation.**

THE FOREGOING WARRANTY IS EXCLUSIVE AND IN LIEU OF ALL OTHER WARRANTIES OF MERCHANTABILITY OR FITNESS FOR A PARTICULAR PURPOSE.

### OBLIGATIONS

For one year from the date of purchase, Sanyo Manufacturing Corporation warrants this product to be free from defects in material and workmanship under normal use and conditions. During the first 90 days under this warranty for any manufacturing defect or malfunction Sanyo Manufacturing Corporation will provide a new TV via exchange at the retailer.

### HOW TO MAKE A CLAIM UNDER THIS WARRANTY

**Please call 1-800-877-5032.** Please be prepared to give us the television's model number and serial number when you call. The model number and serial number are **printed on a label attached to** the back of the unit.

**For customer assistance, call toll free 1-800-877-5032.**

**Weekdays 7:30 AM – 7:00 PM Central Time**

**Saturday 7:30 AM – 4:00 PM Central Time**

This warranty expresses specific contractual rights; retail purchasers may have additional statutory rights which vary from state to state.

(EFFECTIVE: March 1, 2007)

For your protection in the event of theft or loss of this product, please fill in the information requested below and **KEEP IN A SAFE PLACE FOR YOUR OWN PERSONAL RECORDS.**

Model No. \_\_\_\_\_

Date of Purchase \_\_\_\_\_

Serial No. \_\_\_\_\_

Purchase Price \_\_\_\_\_

(Located on back of unit)

Where Purchased \_\_\_\_\_



Sanyo Manufacturing Corp.  
3333 Sanyo Road, Forrest City, AR 72335



## Free Manuals Download Website

<http://myh66.com>

<http://usermanuals.us>

<http://www.somanuals.com>

<http://www.4manuals.cc>

<http://www.manual-lib.com>

<http://www.404manual.com>

<http://www.luxmanual.com>

<http://aubethermostatmanual.com>

Golf course search by state

<http://golfingnear.com>

Email search by domain

<http://emailbydomain.com>

Auto manuals search

<http://auto.somanuals.com>

TV manuals search

<http://tv.somanuals.com>