

OPERATING INSTRUCTIONS

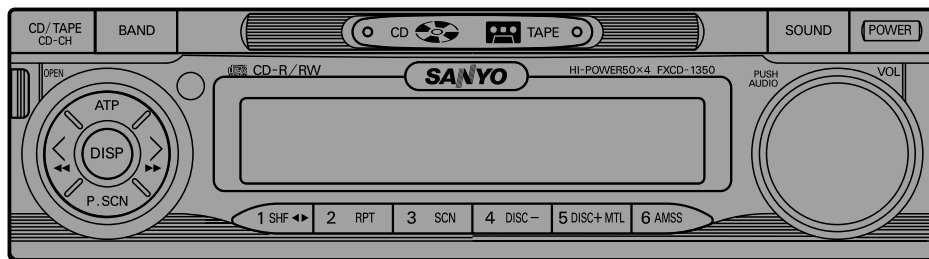

FXCD-1350

**Fold Down Design Full Panel Detachable
FM Stereo/AM Receiver
Auto Reverse Cassette Player
Compact Disc Player
With CD Changer Controller
ISO Mounting with Removable Trim Ring**



(English)

OPERATING INSTRUCTIONS..... 1~29

(Español)

LIBRITO DE INSTRUCCIONES..... 30~57

GB

E

**SANYO MOBILE AUDIO
MODEL FXCD-1350
LIMITED WARRANTY**

OBLIGATIONS

In order to obtain warranty service, the product must be delivered to and picked up from an Authorized Sanyo Factory Service Center at the user's expense, unless specifically stated otherwise in this warranty. The names and addresses of Authorized Sanyo Service Center may be obtained by calling the toll-free number listed below.

For product operation, authorized service center referral, service assistance or problem resolution, call

CUSTOMER INFORMATION 1-800-421-5013

Weekdays 8:00 AM - 5:00 PM Pacific Time

For accessories and/or parts not available from an authorized dealer, call

PARTS ORDER INFORMATION 1-800-726-9662

Weekdays 8:00 AM - 5:00 PM Pacific Time

THIS WARRANTY IS VALID ONLY ON SANYO PRODUCTS PURCHASED AND USED IN THE UNITED STATES OF AMERICA. THIS WARRANTY APPLIES ONLY TO THE ORIGINAL RETAIL USER, AND DOES NOT APPLY TO PRODUCTS USED FOR ANY INDUSTRIAL, PROFESSIONAL OR COMMERCIAL PURPOSE. THE ORIGINAL DATED BILL OR SALE OR SALES SLIP MUST BE SUBMITTED TO THE AUTHORIZED SANYO SERVICE CENTER AT THE TIME WARRANTY SERVICE IS REQUESTED.

Subject to the OBLIGATIONS above and EXCLUSIONS below, SANYO FISHER COMPANY(SFC) warrants this SANYO product against defects in materials and workmanship for the periods specified below. SFC will repair or replace (at its option) the product and any of its parts which fail to conform to this warranty. The warranty period commences on the date the product was first purchased at retail.

LABOR	PARTS
1 YEAR	1 YEAR

EXCLUSIONS

This warranty does not cover (A) the adjustment of customer-operated controls as explained in the appropriate model's instruction manual, or (B) the repair of any product whose serial number has been altered, defaced or removed.

This warranty shall not apply to the cabinet or cosmetics parts, knobs or routine maintenance.

This warranty does not apply to uncrating, setup, installation, removal of the product for repair or reinstallation of the product after repair.

This warranty does not apply to repairs or replacements necessitated by any cause beyond the control of SFC including, but not limited to, any malfunction, defect or failure caused by or resulting from unauthorized service or parts, improper maintenance, operation contrary to furnished instructions, shipping or transit accidents, modification or repair by the user, abuse, misuse, neglect, accident, incorrect power line voltage, fire, flood or other Acts of God, or normal wear and tear.

The foregoing is in lieu of all other expressed warranties and SFC does not assume or authorize any party to assume for it any other obligation or liability.

THE DURATION OF ANY WARRANTIES WHICH MAY BE IMPLIED BY LAW (INCLUDING THE WARRANTIES OF MERCHANTABILITY AND FITNESS) IS LIMITED TO THE TERM OF THIS WARRANTY. IN NO EVENT SHALL SFC BE LIABLE FOR SPECIAL, INCIDENTAL OR CONSEQUENTIAL DAMAGES ARISING FROM OWNERSHIP OR USE OF THIS PRODUCT, OR FOR ANY DELAY IN THE PERFORMANCE OF ITS OBLIGATIONS UNDER THIS WARRANTY DUE TO CAUSES BEYOND ITS CONTROL. SOME STATES DO NOT ALLOW LIMITATIONS ON HOW LONG AN IMPLIED WARRANTY LASTS AND/OR DO NOT ALLOW THE EXCLUSION OR LIMITATION OF CONSEQUENTIAL DAMAGES, SO THE ABOVE LIMITATIONS AND EXCLUSIONS MAY NOT APPLY TO YOU.

THIS WARRANTY GIVES YOU SPECIAL LEGAL RIGHTS. YOU MAY HAVE OTHER RIGHTS, WHICH VARY FROM STATE TO STATE.

ATTENTION

For your protection in the event of theft or loss of this product, please fill in the information below for your own personal records.

Model No. _____ Serial No. _____
(Located on back or bottom side of unit)

Date of Purchase _____ Purchase Price _____

Where Purchased _____

WARNING : TO PREVENT FIRE OR SHOCK HAZARD, DO NOT EXPOSE THIS APPLIANCE TO RAIN OR MOISTURE.

CONTENTS

COMPACT DISC CARE	3
REMOTE CONTROLLER	5
DIGITAL DISPLAY	7
DETACHABLE FRONT PANEL	8
GENERAL OPERATION	9
RADIO OPERATION	11
TAPE OPERATION	13
CD OPERATION	15
CD CHANGER OPERATION	17
ERROR SIGNS	19
CLOCK	20
HINTS FOR PROPER AND SAFE OPERATION	21
TROUBLESHOOTING	22
ACCESSORIES AND HARDWARE	23
INSTALLATION	23
UNIT REMOVAL	26
ELECTRICAL CONNECTIONS	27
LINE OUT / CD CHANGER CONNECTIONS	28
SPECIFICATIONS	29

NOTE

This equipment has been tested and found to comply with the limits for a Class B digital device, pursuant to Part 15 of the FCC Rules. These limits are designed to provide reasonable protection against harmful interference in a residential installation. This equipment generates, uses, and can radiate radio frequency energy and, if not installed and used in accordance with the instructions, may cause harmful interference to radio communications. However, there is no guarantee that interference will not occur in a particular installation. If this equipment does cause harmful interference to radio or television reception, which can be determined by turning the equipment off and on, the user is encouraged to try to correct the interference by one or more of the following measures:

- Reorient or relocate the receiving antenna.
- Increase the separation between the equipment and receiver.
- Connect the equipment into an outlet on a circuit different from that to which the receiver is connected.
- Consult the dealer or an experienced radio/TV technician for help.

CAUTION

- This unit is designed to operate on 12 volts DC, NEGATIVE ground electrical systems only.
- When fuse replacement is necessary, use only a 15 amp fuse. Do not replace with a higher rated fuse. If the fuse blows often, carefully check all electrical connections for any short circuits and have your car's voltage regulator checked also.
- Do not install the unit where it will be exposed to direct sunlight or hot air discharged from the car heater.
- Do not expose the unit to water or moisture.
- To avoid damaging the unit, never insert anything other than a compact disc into the disc slot.
- This unit should not be adjusted or repaired by anyone except qualified service personnel. If servicing is required, return the unit to an authorized SANYO mobile audio dealer.
- Use of controls or adjustments or performance of procedures other than those specified herein may result in hazardous radiation exposure.
- Changes or modifications not expressly approved by Sanyo may void the user's authority to operate this equipment.

COMPACT DISC CARE

Dirt, dust, scratches and warpage can cause a deterioration in the sound or intermittent skipping some tracks during play.



- This unit has been designed to play compact discs bearing the identification logo shown on the left. Discs bearing other types of identification logos may not play properly.
- Playback may not be possible due to the characteristics of the CD recorder or the CD-R/RW used, or due to scratches or dirt on the CD.
- For some CD-R/RWs, depending on the quality of their recording or storage media used, playback may not be possible due to deterioration of recorded material.

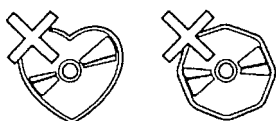

- Do not use non-conventional discs such as heart-shaped, octagonal discs, etc. The player could be damaged.

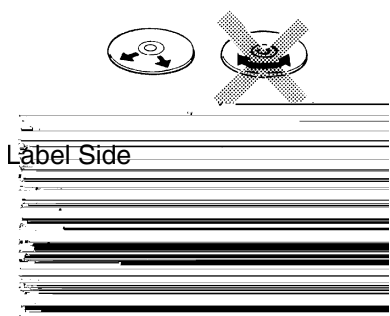

- Fingerprints and dust should be carefully wiped from the signal surface of the disc (glossy side) with a soft cloth. Wipe in a straight motion from the inside to the outside of the disc. Unlike conventional records, the compact disc has no grooves to collect dust and debris. Small dust particles will have no effect on reproduction quality.
- Do not insert a disc which is cracked into the unit.
- Do not apply paper or write anything on the disc.

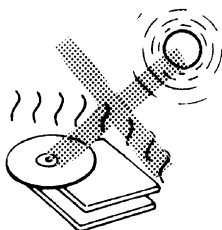

- To prevent warping the disc, do not expose it to direct sunlight, high humidity or high temperatures for extended periods.

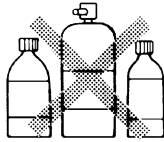

Benzene Thinner Cleaning spray



- Never use chemicals such as record cleaning sprays, antistatic sprays or fluids, benzene or thinner to clean compact discs. These chemicals will permanently damage the plastic surface of the disc.
- When not using the disc player for extended periods, remove the compact disc and return it to the plastic storage case. This will protect the disc from dust and exposure to the sun.

- **Mixed-mode CDs**

This product can only play audio tracks on mixed-mode CDs.

The initial track contains non-audio data, and so it does not produce any sound.

Playback will start from the next track.

(Mixed-mode CDs are CDs which contain both non-audio data and audio tracks.)

- **CDs containing copy control protection technology.**

It is possible that some CDs with copy control protection (added to prevent computer duplication) may not play on this unit.

This is due to the CD with copy control protection not conforming to CD standards and is not due to a malfunction of this unit.

If there are any problems playing a CD with copy control protection, consult the store where the CD was purchased.



REMOTE CONTROLLER

REMOTE CONTROLLER OPERATION

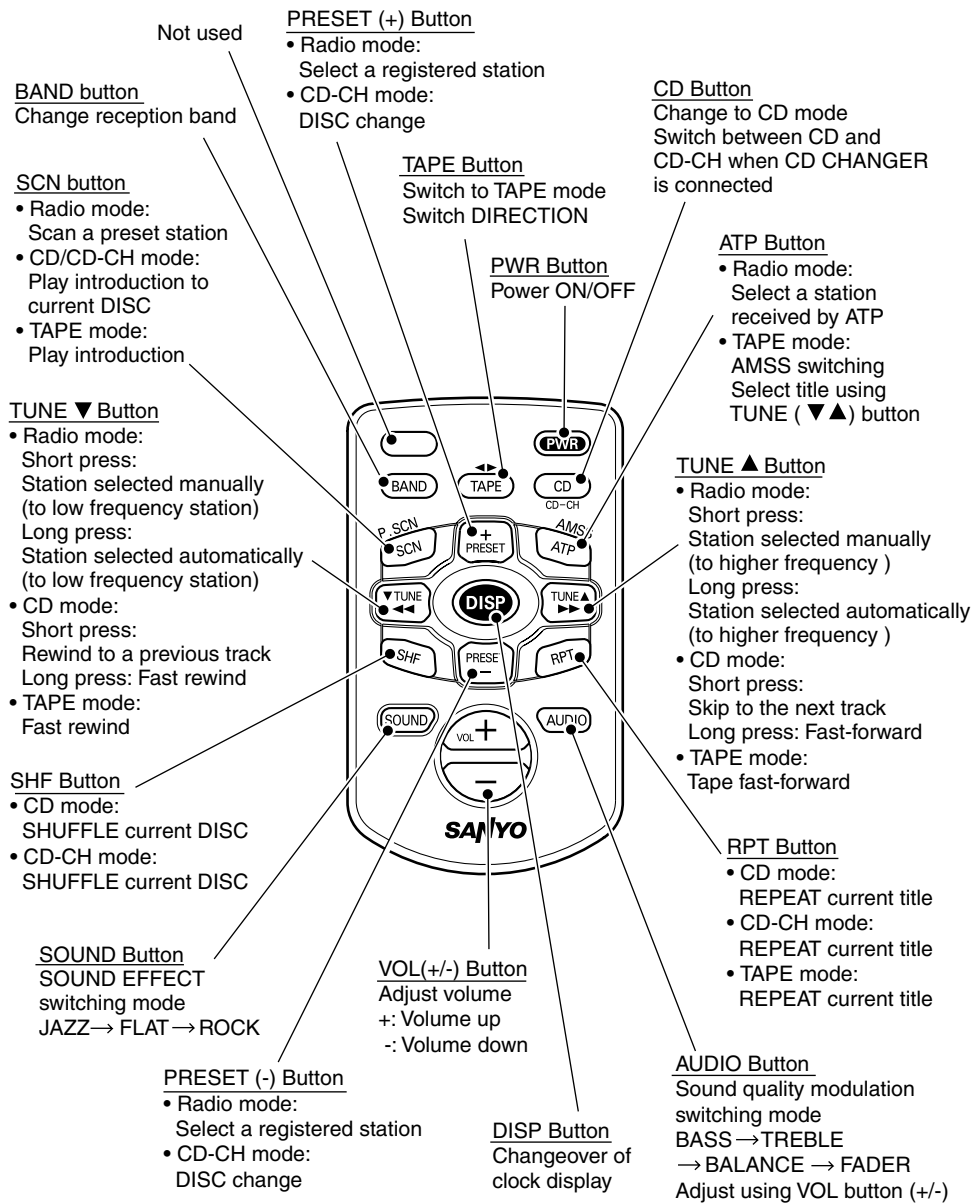

CAUTION

- For the purpose of safe driving, a passenger other than a driver should operate a remote controller while the vehicle is being driven, or the operation should be done after parking the vehicle in a safe area.

BATTERY INSTALLATION

Install a lithium battery (CR2025) with the poles facing the correct direction.

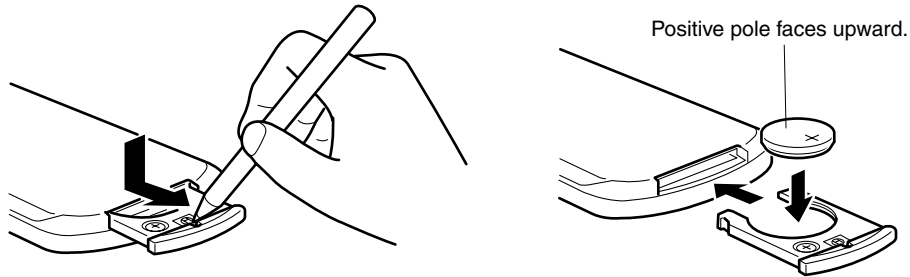

BATTERY REPLACEMENT TIMING

When battery power is depleted, the buttons may not be operable.

If the remote controller does not operate, replace the battery and check the operation.

CAUTIONS REGARDING BATTERY

Be sure to follow the instructions to prevent battery leakage, over-heating, ignition, or explosion.

⚠ WARNING

- Do not expose the battery to flame. Do not short circuit, disassemble, or heat the battery.
- Do not charge the battery.
- Use the specified type battery.
- Keep the button-shaped battery away from children to prevent accidental swallowing.
- If the battery is swallowed, contact a doctor immediately.

⚠ CAUTION

- Install the battery with the poles facing the correct direction.
- When not in use for a long period of time, or if the battery is dead, remove the battery from the remote controller.

If battery leakage has occurred, wipe the container first, then install a new battery. If the battery solution contacts the skin, wash off with water completely.

CAUTIONS REGARDING REMOTE CONTROLLER

- Do not leave the remote controller in an area exposed to direct sunlight, such as on the dashboard or steering wheel. The remote controller may deform because of the heat. (Be especially careful of the dashboard exposed to direct sunlight in the summer, as it will become extremely hot.)
- When the vehicle is parked in an area exposed to direct sunlight, remove the remote controller from its holder and put it in a shaded spot such as the glove box.
- Under direct sunlight, signal reception from the remote controller becomes weakens. If this happens, hold the remote controller close to the signal receptor on the front panel.

DIGITAL DISPLAY

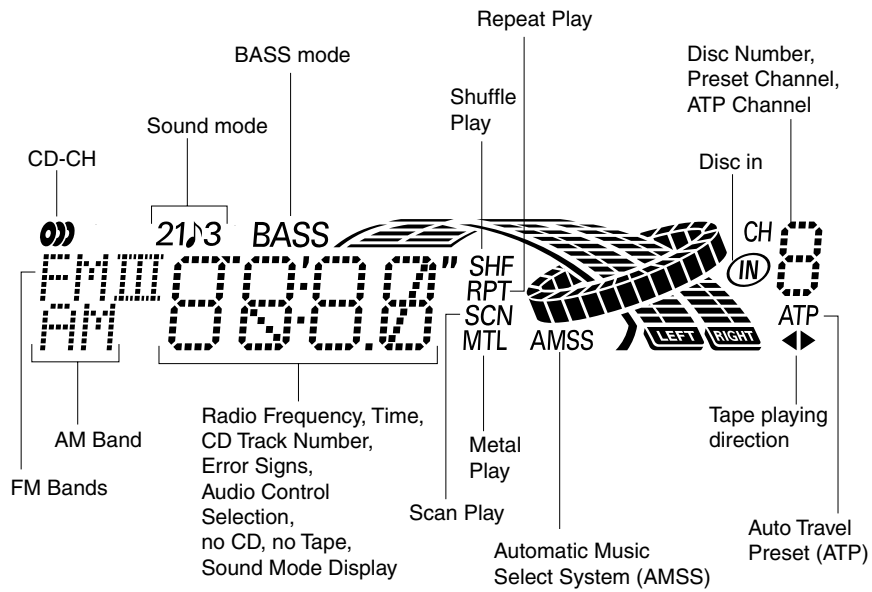

DETACHABLE FRONT PANEL

The front panel is designed to be removable for antitheft purposes. It is recommended that you remove and carry the front panel with you when you leave your car. A carrying case is provided with the unit for this purpose.

HOW TO DETACH THE FRONT PANEL

- 1 Press the open button to open the door.
- 2 Pull the right side of the panel, then pull the left side of the panel to remove it from the unit.

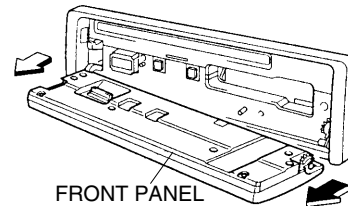
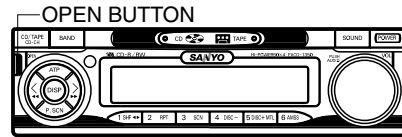

HOW TO REPLACE THE FRONT PANEL

Align the right side of the panel with the stopper, and then push the left side of the panel into the unit until it clicks.

Note

The unit will not operate if it is installed incorrectly.

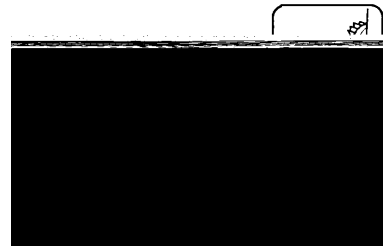

SECURITY

To avoid theft or loss of the front panel, you can inactivate the release knob by installing the screw provided as shown.

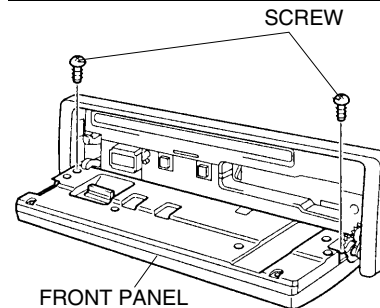

CAUTION

- Do not attempt to remove the panel in a manner other than that described above.
- When installing the panel, do not force it into the unit.
- Do not touch the connection terminals of the panel or the unit. It may cause poor contact.
- Use a clean, dry cloth when cleaning the terminals.
- Keep the panel out of direct sunlight and high temperatures.
- Prevent the panel from coming into contact with benzene, thinner, or insecticides.
- Do not drop the panel.
- Do not attempt to remove the radio front panel that takes your attention away from safety driving your vehicle.

GENERAL OPERATION

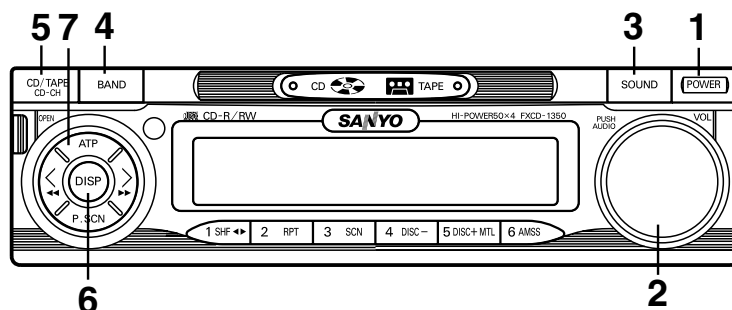

TURNING THE POWER ON..... 1

Install the front panel and press the POWER button ① when ACC is on.

TURNING THE POWER OFF 1

Press the POWER button ① to stop the current operation.
The button dims when the power is off (ACC on).

ELECTRONIC CONTROLS..... 2

Press the AUDIO button ②, then press the AUDIO button ② to select the audio functions as shown in the table below.

Turn the VOL knob ② to adjust the selected function ; bass, treble, balance, fade, or volume.

Note

While no other mode is displayed, the VOL knob function as a volume control.

MODE	Turn left (Min)	Turn right (Max)
bAS(bass)	Down -5	UP +5
TRE(treble)	Down -5	UP +5
bAL(balance)	Left L9	Right R9
FAd(fader)	Rear R9	Front F9
VOL(volume)	Down 0	UP 35

SOUND EFFECT BUTTON 3

Press the SOUND Button ③ for less than 1.5 second.

Each time the button is pressed, the function changes as shown below.

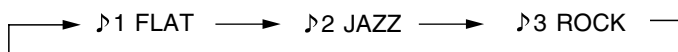

BASS CONTROL..... 3

Press the SOUND button ③ for more than 1.5 second to switch ON/OFF of the BASS mode. When the BASS mode is on, "BASS" is displayed and the bass enhances.

RADIO SELECTION BUTTON (BAND) 4

Press the BAND button ④ to switch from CD player, CD changer or tape mode to radio. Each time the button is pressed, the function changes as shown below.

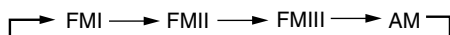

TAPE, CD PLAYER OR CD CHANGER* SELECTION BUTTON (CD/TAPE/CD-CH) 5

Press the CD/TAPE/ CD-CH button ⑤ to switch from radio or tape mode to CD player or CD changer* mode. *If a CD changer is connected.

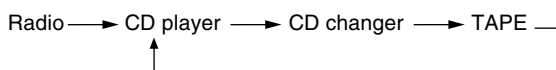

Notes

- When a CD is not loaded in the CD player, the CD player mode is skipped.
- When a cassette is not loaded in the cassette player, the TAPE mode is skipped.
- When a CD changer is not connected, the CD changer mode is skipped.

CLOCK BUTTON (DISP) 6

Press the DISP button ⑥ to switch between the clock and audio display. When an audio function is performed while the time display is selected, the audio display will appear for 5 seconds, then the display will return to the time mode.

TO CANCEL THE BEEP TONES 1, 7

- 1 Turn off the power by depressing the POWER button ①.
- 2 To cancel all beep tones, press the POWER button ① and the ATP button ⑦ simultaneously for more than 3 seconds and then "bP : OF" is displayed.
- 3 To turn on the beep tones again, perform the same procedure. The beep tones are set and "bP : on" is displayed.

RADIO OPERATION

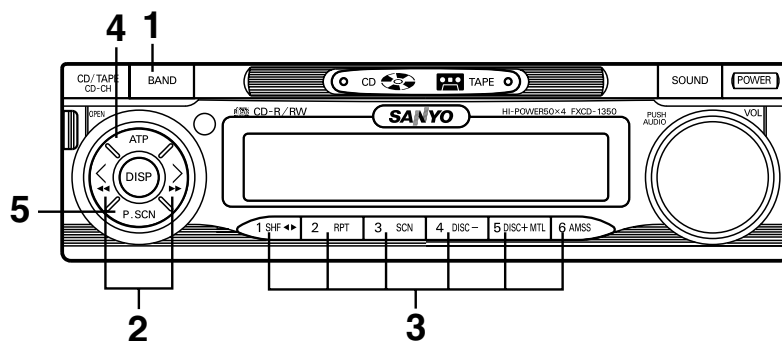

SELECTING RADIO MODE 1

Press the BAND button ① to switch from CD player, CD changer or tape mode to the radio. Each time the BAND button is pressed, the selected band changes as shown below.

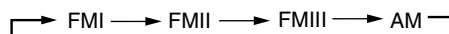

RADIO TUNING 2

- Automatic tuning Press the > or < button ② for more than 0.5 second until it beeps twice if the beep tones are on. When the button is released, the system will start automatic tuning and stop at the next receivable station.
- Manual tuning To select higher frequency stations, press the > button for less than 0.5 second. To select lower frequency stations, press the < button for less than 0.5 second. To quickly scan up or down in frequency, press and hold the > or < button. Release the button when the display approaches the desired frequency, then press and release the button repeatedly until the desired frequency is displayed.

STORING PRESET STATIONS 3

The preset buttons ③ can be used to store 6 stations in each band (FMI, FMII, FMIII and AM) for convenient access to your favorite stations.

- Programming stations.....
 - 1 Select the desired band, then tune in the station you want to store in memory.
 - 2 Press and hold one of the preset buttons for more than 2 seconds. Repeat steps 1 and 2 to program additional stations.
- Quick tuning Select the desired band, then press one of the six preset buttons.

ATP (AUTO TRAVEL PRESET) OPERATION..... 4

The Auto Travel Preset function searches for and memorizes the 6 strongest stations in one of the two bands (FM, AM) in the order of signal strength.

This feature is useful when you are driving in an unfamiliar location and want to memorize local stations without changing the standard preset stations.

A total of 12 stations (6 FM and 6 AM) can be programmed.

- To set the stations.....
 - 1 Select the desired band.
 - 2 Press and hold the ATP button ④ for more than 2 seconds.
“ATP” appears in the display.
When the stations have been memorized, scanning stops and the strongest station is selected.
- Quick Tuning of ATP Stations
 - 1 Select the desired band.
 - 2 Press the ATP button if the “ATP” indicator does not appear in the display.
 - 3 While ATP is illuminated, press the ATP button and the unit seeks ATP1-6. If there is no preset ATP, - 0 - appears in the display.
- To scan programmed stations..... See “PRESET-SCAN-BUTTON OPERATION”.

Notes

- If no station can be received, “- 0 -” appears in the display.
- If fewer than 6 stations can be received, the system will memorize as many stations as possible, then select the strongest one.
- If ATP mode is selected in FMII band, FM ATP mode is selected.

To cancel the ATP, press the BAND button ①. When ATP is canceled, the ATP indicator disappears and ATP mode is canceled.

PRESET-SCAN-BUTTON OPERATION 1, 4, 5

This function scans each of the preset stations stored in the selected band (both manual preset and auto travel presets).

- 1 Select the desired band or ATP mode.
Press the BAND button ① for FMI, FMII, FMIII or AM. Press the ATP button ④ to select the ATP mode.
- 2 Press the P.SCN button . The system will select and receive each preset station for five-second.
- 3 To stop scanning and retain the station currently selected, press the P.SCN button again during this five-second period.

TAPE OPERATION

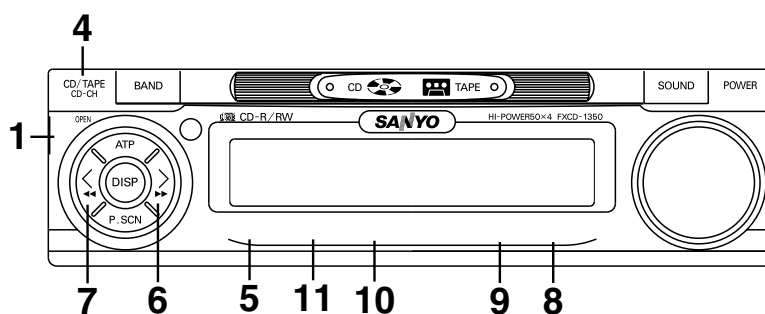

LOADING AND EJECTING THE TAPE 1, 2, 3

Press the OPEN button ① to open the door.

Insert a cassette into the tape slot ② and the tape player will start.

Press the eject button ③ to eject a tape.

⚠ CAUTION

- Only cassette tapes that play no longer than 90 minutes should be used. Tapes exceeding 90 minutes are thin and may easily break.

SELECTING TAPE MODE 4

Inserting a cassette into the tape slot as start the tape player. If radio, CD player or CD changer* is in operation with a tape loaded, press the TAPE button ④ to switch to tape mode.

* If a CD changer is connected.

SWITCHING THE TAPE DIRECTION 5

Press the button .

When the tape reaches the end of one side, the unit will automatically switch to the opposite side of the tape.

FAST FORWARD AND REWIND 6, 7







Press the > button ⑥ to fast forward and press the < button ⑦ to rewind the tape.

Pressing the button during fast forward and rewind operation resumes tape playing.

LOCATING THE BEGINNING OF A PROGRAM

(AMSS) 6, 7, 8

This system is equipped with a function that allows you to skip forward or backward to locate the beginning of a particular selection on the tape. (Automatic Music Select System : AMSS)

- 1 Press the AMSS button . "AMSS" is displayed.
- 2 Press the > button  to skip forward up to 9 selections from the current location on the tape.
e.g.) With "AMSS" displayed, press button  three times. "F3" is displayed.
The system will search for 3 blank spaces between selections in the forward direction, then begin playing the third selection from the starting point.
- 3 Press the < button  to skip backward to the beginning of the current selection, or up to 8 selections from the current location on the tape.
e.g.) With "AMSS" displayed, press button  five times. "R5" is displayed.
The system will search for 5 blank spaces between selections in the backward direction, then begin playing the fourth selection from the starting point. (The blank space before the current selection counts as one blank space.)
- 4 To cancel AMSS mode, press button  again.



Notes

- If AMSS detects 15 seconds of blank space, it will automatically advance the tape to the next selection.
- AMSS may not operate properly if
 - A tape was recorded at a low level.
 - A tape has long, silent intervals.
 - A tape is a live recording.

METAL PLAY MODE 9

If a metal or high-position tape is used, press the MTL button  to make the player in metal play mode. MTL is indicated.

SCAN MODE 10

Scan helps to find a program by playing about the first 10 seconds of each selection. Press the SCN button  during play to start scan operation. "SCN" is displayed. To cancel scan, press the SCN button  again.

REPEAT MODE..... 11

This operation makes it possible to listen repeatedly to a selection. Press the RPT button  during play. "RPT" is displayed, the selection playing will continue until RPT is pressed again.

Notes

- RPT/SCN may not operate properly if
 - A tape was recorded at a low level.
 - A tape has long, silent intervals.
 - A tape is a live recording.

CD OPERATION

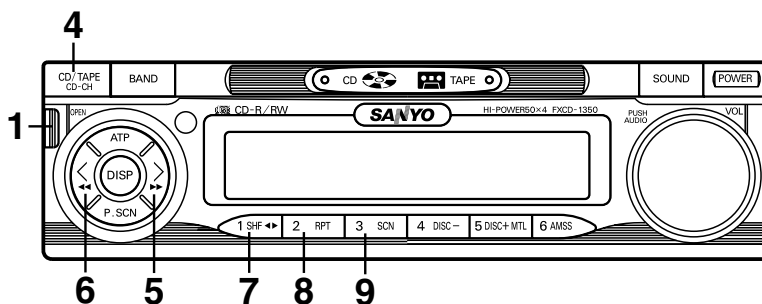

LOADING AND EJECTING THE CD 1, 2, 3

Press the OPEN button ① to open the door.

Insert a disc into the CD slot ② and the CD player will start.

Press the eject button ③ to eject a disc.

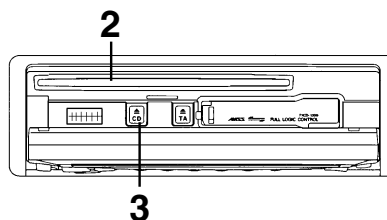

⚠ CAUTION

- This CD player is not designed for 8 cm CDs. Please do not use an 8 cm CD nor 8 cm CD adaptor.
- If the unit is already loaded with a CD, please do not attempt to insert another disc, which may result in damage to both of the discs and the unit.

Note

When the CD is ejected, "no" "Cd" will be flash alternately.

SWITCHING TO CD MODE..... 4

Press the CD / TAPE / CD-CH button ④ to switch from radio or tape or CD changer* mode to CD player mode.

When the CD mode is switched on while a disc is loaded, play resumes from the point at which play was stopped.

When the entire disc has played, the unit returns to the first track and play resumes.

The CD player continues playing the disc until the POWER button is pressed, the other mode is selected, or the disc is ejected.

* If a CD changer is connected.

SKIPPING TRACKS..... 5, 6

Press the > button to skip to the beginning of the next track.

Press the < button Ⓢ to skip to the beginning of the track currently playing.

Press the < button Ⓢ twice to skip to the beginning of the previous track.

Press and hold the > or < button for more than 0.5 seconds to search quickly (with sound) in the forward or reverse direction.

When the button is released, the CD resumes normal play.

SHUFFLE MODE..... 7

This function plays the tracks on a CD in random order.

Press the SHF button Ⓢ to begin shuffle play. The SHF indicator lights.

Press the > or < button to select another random track.

To cancel this mode, press the SHF button Ⓢ again or eject the CD.

Notes

If a disc is already loaded under the following conditions, shuffle play will resume from the point at which play was stopped:

- *If the vehicle ignition is turned off, then on again.*
- *If the power is switched off, then on again with the ON/OFF button.*

REPEAT MODE..... 8

Press the RPT button Ⓢ to play the current track repeatedly. The RPT indicator lights.

To cancel this mode, press the RPT button Ⓢ again or eject the CD.

Notes

If a disc is already loaded under the following conditions, repeat play will resume:

- *If the vehicle ignition is switched off, then on again.*
- *If the power is switched off, then on again with the ON/OFF button.*

SCAN MODE (PLAYING THE BEGINNING OF EACH TRACK)..... 9

This function plays the first 10 seconds of each track sequentially.

Press the SCN button Ⓢ to begin the scan mode. The SCN indicator lights.

To cancel this mode, press the SCN button Ⓢ again.

Note

Scan mode will be canceled when the vehicle ignition is turned off, or when the disc is ejected.

CD CHANGER OPERATION

THE UNIT CAN BE USED TO CONTROL THE FUNCTIONS OF THE COMPATIBLE SANYO CD CHANGERS. (If a CD changer switch is equipped, always set it to "1".)

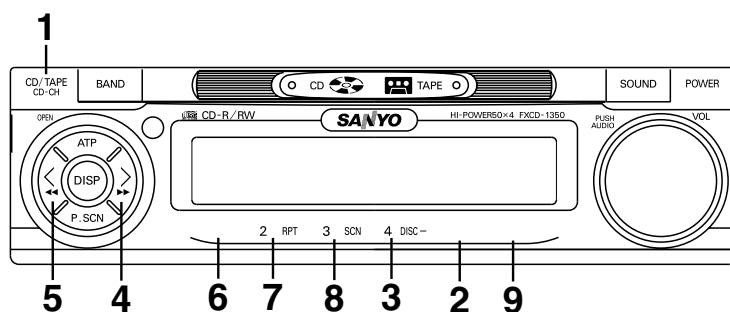

SELECTING CD CHANGER MODE 1

Press the CD/TAPE/CD-CH button ① to switch from radio, tape or CD player mode to CD changer mode.

SELECTING A DISC 2, 3

Press the DISC + button ② to select the next disc.

Press the DISC - button ③ to select the preceding disc.

SKIPPING TRACKS 4, 5

Press the > button ④ to skip to the beginning of the next track.

Press the < button ⑤ to skip to the beginning of the track currently playing.

Press the < button ⑤ twice to skip to the beginning of the previous track.

Press and hold the > or < button for more than 0.5 second to search quickly (with sound) in the forward or reverse direction.

When the button is released, the CD resumes normal play.

SHUFFLE MODE 6



This function plays the tracks on one CD or all CDs in the magazine in random order.

- "Shuffle-playing" tracks; Press the SHF button ⑥ to play tracks on the current disc in random order. The SHF indicator lights.
- "Shuffle-playing" discs; Press the SHF button ⑥ for more than 1.5 seconds. The SHF indicator blinks. The system selects a disc at random and plays all tracks on that disc. When all tracks have been played, the next disc is selected and "shuffle-play" is repeated.

To cancel the track shuffle or disc shuffle mode, press the SHF button ⑥ again, press the DISC + or - button or eject the magazine.

The system will remain in this mode until it is cancelled.

REPEAT MODE..... 7



- Repeat tracks Press the RPT button  to play the current track repeatedly. The RPT indicator lights.
- Repeat discs Press the RPT button  for more than 1.5 seconds to play the current disc repeatedly. The RPT indicator blinks.

To cancel the track repeat or disc repeat mode, press the RPT button  again, press the DISC + or - button or eject the magazine.

The system will remain in this mode until it is cancelled.

SCAN MODE (PLAYING THE BEGINNING OF TRACKS OR DISCS) 8

This function plays the first 10 seconds of each track or disc sequentially.

- Playing the beginning of tracks Press the SCN button  to play the first 10 seconds of each track on the current disc in order. The SCN indicator lights.
- Playing the beginning of discs..... Press the SCN button  for more than 1.5 seconds to play the first 10 seconds of each disc in the magazine. The SCN indicator blinks.

To cancel the track scan or disc scan mode, press the SCN button  again or press the DISC + or - button.

Note

Scan mode will be canceled when the vehicle ignition is turned off or when the magazine is ejected.

ERROR SIGNS

CD Player

If a problem should occur while operating the built-in CD player, one of the following error signs may be displayed:

Symptom	Cause	Solution
E01	Abnormal CD mechanism function.	Press the eject button. Turn the power off and then on again. If it is not corrected, contact the place of purchase.
E07	The disc was inserted incorrectly.	Insert the disc properly.
	The disc is dirty.	Clean the disc.
	The disc is defective.	Use another disc.
	There is condensation on the optical lens.	Leave the disc player off for an hour or so, then try again.
E99	Internal connection check error.	Turn the power off and then on again. If it is not corrected, contact the place of purchase.

CD Changer

If a problem should occur while operating the connected CD changer, one of the following error signs may be displayed.

Symptom	Cause	Solution
E01	Abnormal mechanism function	Contact the place of purchase.
E07	The disc was inserted incorrectly.	Insert the disc properly.
	The disc is dirty.	Clean the disc.
	The disc is defective.	Use another disc.
	There is condensation on the optical lens.	Leave the disc player off for an hour or so, then try again.
		Refer to the instructions supplied with the CD changer.
no Cd	The magazine is not fully inserted into the changer. No discs in the magazine.	Completely insert the magazine into the changer until it clicks into place. Load discs into the magazine.

CLOCK

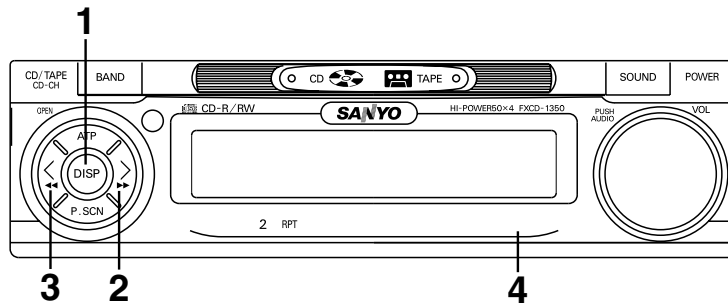

DISPLAY MODE CHANGE..... 1

The display on the unit can be changed by pressing DISP button ①. Press the DISP button ① to switch between the clock and audio display. When a radio, tape and CD function is performed while the time display is selected, the audio display will appear for 5 seconds, then the display will return to the time mode.

ADJUSTING THE TIME 1, 2, 3

To adjust the time, press the DISP button ① for more than 2 seconds. The time display blinks.

To adjust the minute, press the > button ②.

To adjust the hour, press the < button ③.

To advance the time rapidly, hold the > or < button continuously.

Press DISP button ① again to start the clock.

CLOCK RESET 1, 4

Press DISP button ① for more than 2 seconds and the time display blinks. While blinking, press preset button 6 ④ to skip to the nearest half-hour as follows:

Example: 3:00 – 3:29 → 3:00

3:30 – 3:59 → 4:00

HINTS FOR PROPER AND SAFE OPERATION

- **Condensation**

Moisture can condense on the optical lens of the CD player during humid or rainy days, or after the car heater is turned on. If this occurs the disc player may not function properly. To remedy the situation, remove the disc from the unit and wait approximately one hour. This should allow the moisture to evaporate and restore normal operation.

- **Temperature Consideration**

The unit may not operate correctly in extremely hot or cold temperatures. Avoid exposing the unit to extremely high or low temperatures.

- **Interruptions in the sound (skipping)**

When the car is driven on very rough surfaces, the sound from the CD player may skip and be interrupted. This will not cause any damage to the disc or the player. If this occurs, wait for the road surface to improve before using the CD player.

- **Safety**

For safer driving, keep the volume at a moderate level to enable you to hear outside sounds (such as emergency vehicle sirens).

- **Cleaning the unit**

Clean the unit with a soft, dry cloth. Stains should be removed by wiping the surfaces with a soft cloth immersed in lukewarm water and wrung dry. Never use strong chemicals or solvents. These will damage the finish of the unit.

- **Disc care**

When not using the disc player for extended periods, remove the compact disc and return it to the plastic storage case. Do not leave a disc partially ejected from the player.

- **Servicing**

Should a problem develop, do not open the unit or try to repair it yourself. If servicing is required, bring the unit to a Sanyo Authorized Service Center.

TROUBLESHOOTING

Sometimes a simple operational error or a mistake in the wiring can appear to be a problem with the unit. Before having the unit serviced, refer to the troubleshooting chart below.

Symptom	Cause	Solution
The compact disc does not play when inserted into the unit.	The volume control is turned down.	Turn up the volume control.
	The power connections are not wired correctly.	Check the +12V and ground connections.
No sound is coming out.	The speaker code connection is incomplete.	Check the connection of the speaker code, and press the ON/OFF button.
No power.	The vehicle ignition is switched off.	Switch the ignition to the "ON" or "ACC" position.
	The fuse is blown.	Replace the fuse with another 15A fuse.
The unit does not work properly (Eject, Load, Play).	The microcomputer has been affected by electrical noise.	Eject the disc, then insert it again.
The sound from the CD player skips.	The road surface is rough.	Wait for the road surface to improve before playing a disc.
	The unit is not mounted securely.	Install the unit securely.
	The disc is defective.	Try another disc. If it plays properly, the first disc may be defective.
	The disc is dirty.	Clean the disc as explained on pages 3-4.
No radio reception.	The antenna cable is not connected.	Insert the antenna cable firmly into the antenna jack on the unit.
The radio does not stop on any stations when automatic tuning is used.	The signals are weak.	Select a station using manual tuning.

ACCESSORIES AND HARDWARE

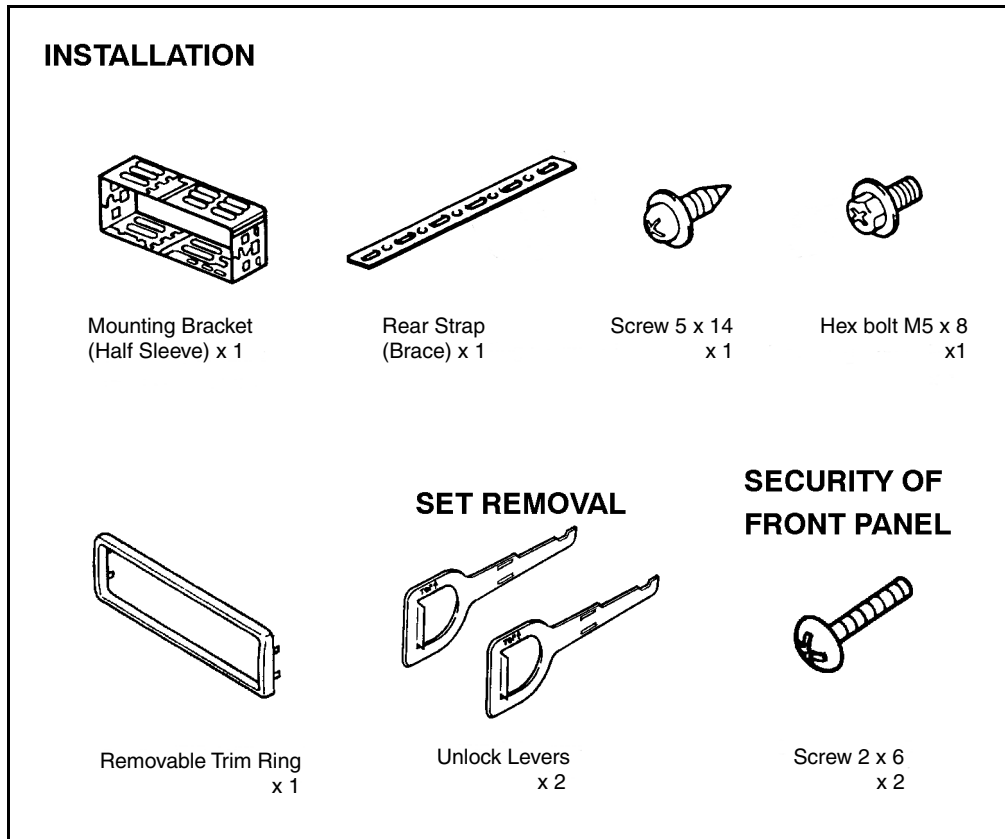

INSTALLATION

1. BEFORE INSTALLATION

When mounting the unit in a car, keep the unit as level as possible. If the unit must be mounted at an angle, due to the design of the vehicle, make sure the unit does not tilt by more than 30°.

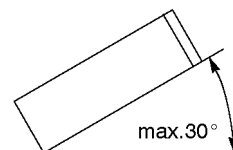

2. ISO MOUNTING WITH REMOVABLE TRIM RING

When mounting the unit into a DIN-standard cutout (182 × 53 mm) in the dashboard or console, attach the provided Removable Trim Ring to the unit.

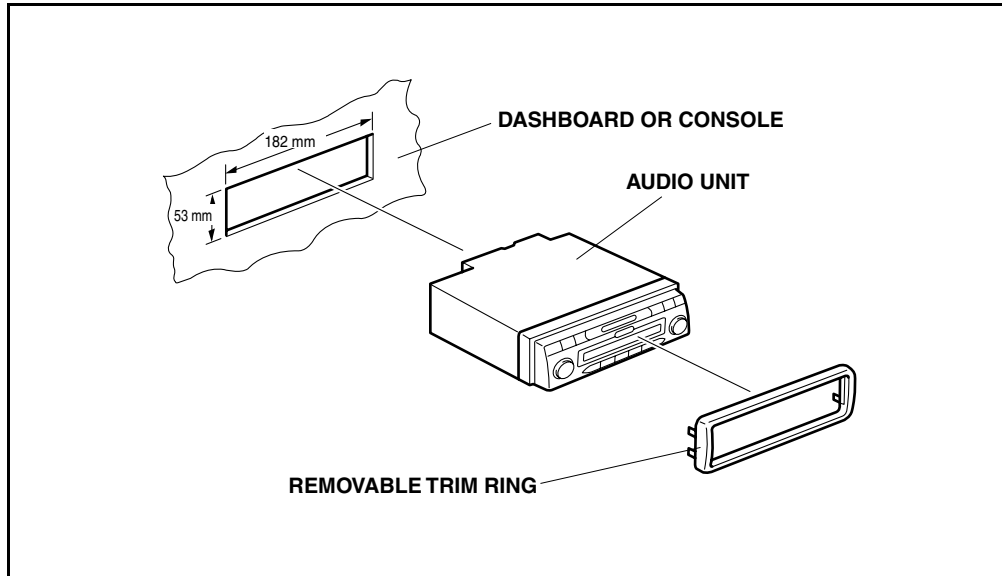

3. INSTALLATION PROCEDURES

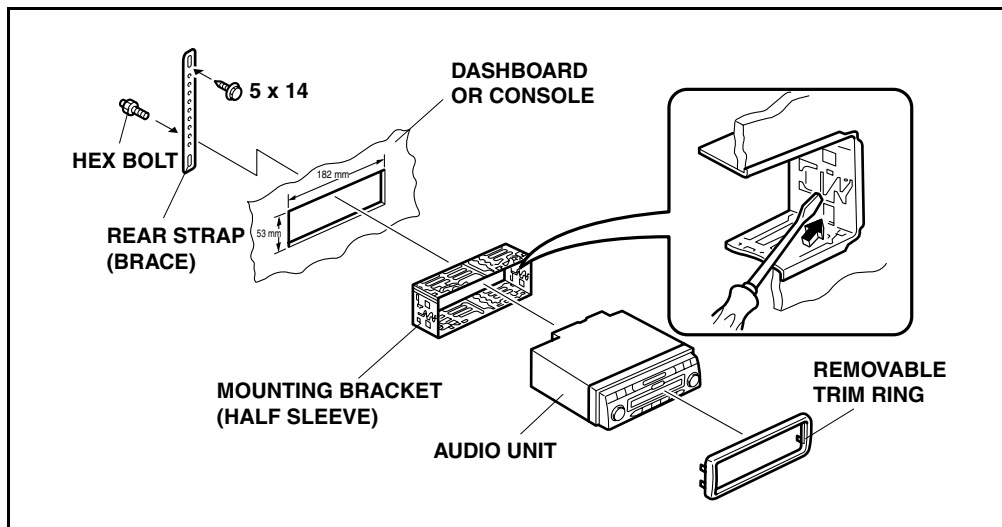

1. Insert the mounting bracket into the DIN-standard cutout (182 × 53 mm) in the dashboard or console.
2. Bend the mounting bracket stopper outward until the bracket fits snugly in the cutout.
3. Push the unit into the mounting bracket until it locks in place.
4. Secure the rear strap to the audio unit and vehicle dashboard.

4. Installation to TOYOTA/NISSAN Vehicles

Install the unit using the existing TOYOTA/NISSAN Mounting Bracket and Screws. Use mounting holes in the unit chassis. "T" or "N" is engraved next to each mounting hole. Use "T" holes for Toyota vehicles and "N" holes for Nissan vehicles.

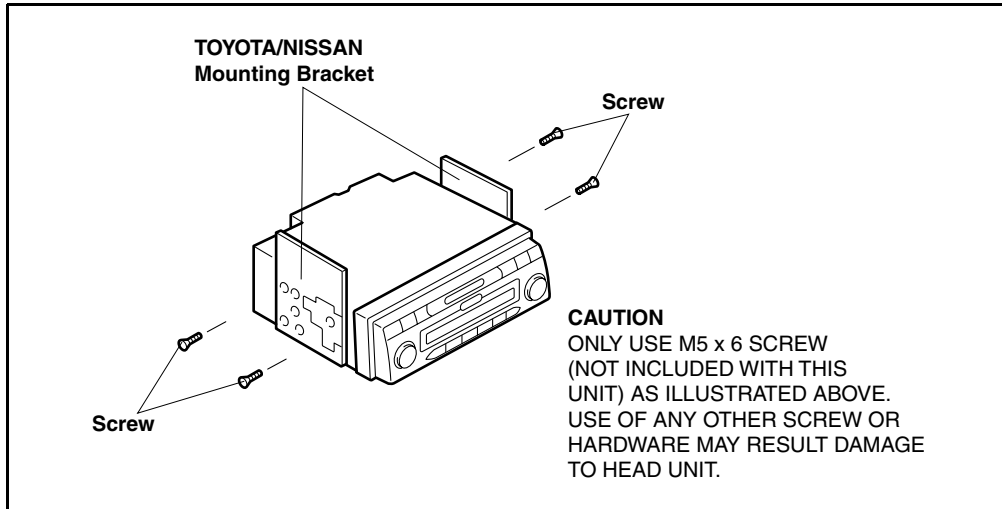

UNIT REMOVAL

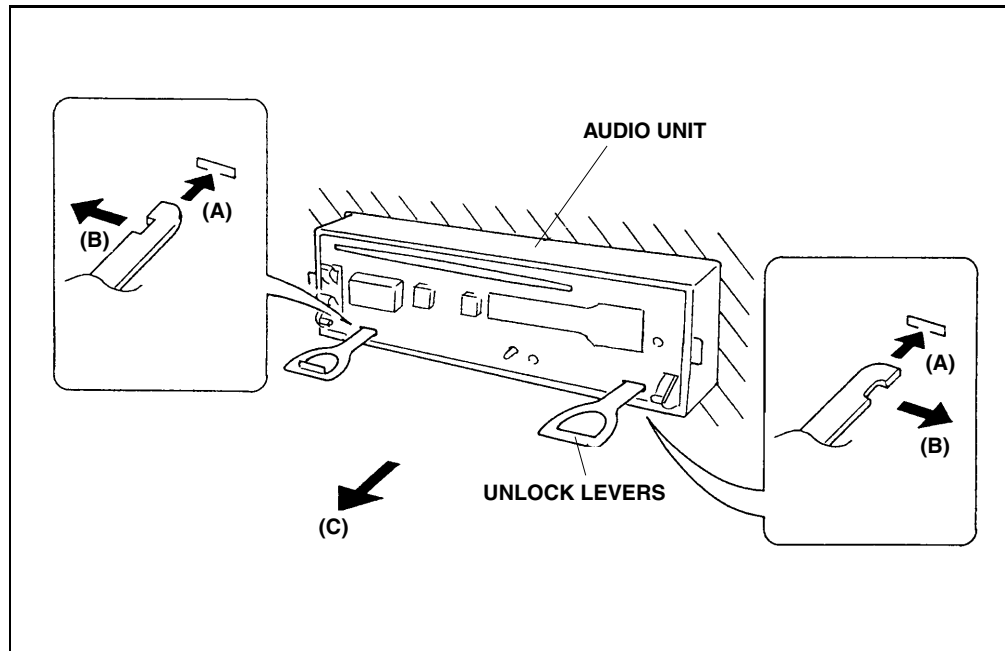

1. Press the open button to open the door.
2. Pull the right side of the front panel, then pull the left side of the panel to remove it from the unit.
3. Insert the unlock levers into the slots as illustrated in (A).

Note

The jagged side of the unlock lever should face outward.

4. Slide both levers outward as illustrated in (B) and pull to remove the audio unit as illustrated in (C).

ELECTRICAL CONNECTIONS

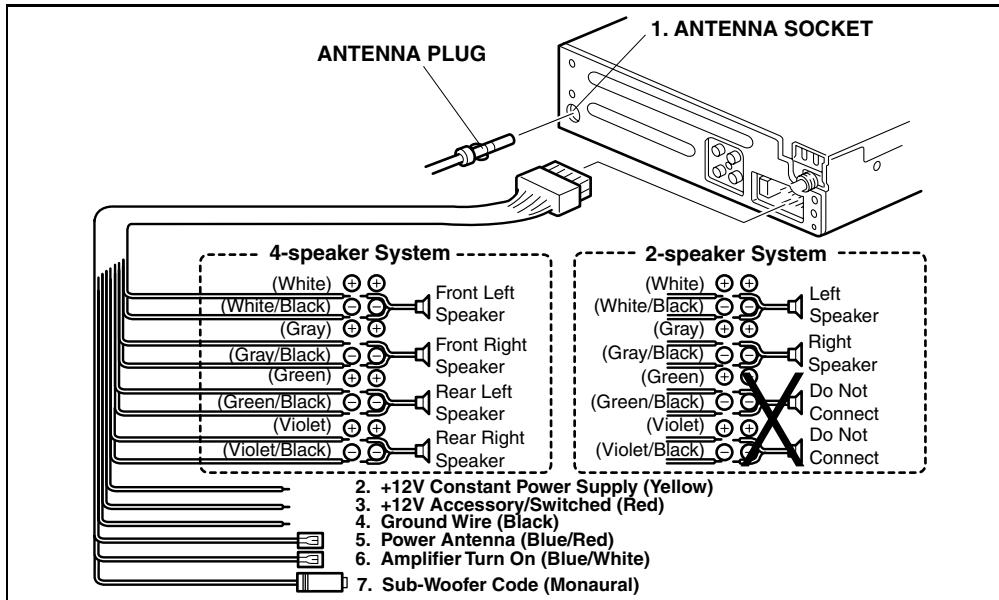

⚠ CAUTION

- DO NOT connect any speaker wires to the metal body or chassis of the vehicle.
- DO NOT connect the speaker common (-) wires to each other.
- Connect each speaker wire directly to each speaker terminal.
- All speaker common (-) wires must remain floating.
- When wiring the amplifier for the sub-woofer, noise may occur depending on where the ground (earth) terminal is installed.

1 Antenna socket

- Insert the plug from the antenna installed in your vehicle into this socket. (If your vehicle has a dual antenna system, a dual antenna to single antenna cable adaptor may be required.)

2 +12V Constant Power Supply (Yellow)

- Connect this wire to the +12V power terminal which receives power continuously.
- Connect to location drawing 10 A amperage or more.

3 +12V Accessory/Switched (Red)

- Connect this wire to the terminal which receives power while the ignition switch is at ON or ACCESSORY position.
- If the ignition switch does not have an ACC position, connect this wire to a +12V power terminal which receives power continuously. (Same as item 2.)
- Connect to location drawing 100 mA amperage or more.

4 Ground wire (Black)

- Connect this wire to the vehicle chassis.

5 Power Antenna (Blue/Red)

- Connect this wire to the control terminal of a Power Antenna.
- When not using a Power Antenna, this wire is not connected.

6 Amplifier Turn On (Blue/White)

- Connect this wire to an external amplifier.
- When not using an external amplifier, this wire is not connected.

7 Sub-Woofer Cord (Monaural)

- Connect this wire to an external sub-woofer amplifier.
- When not using an external sub-woofer amplifier, this wire is not connected.

Notes

- When using a two-speaker installation, the Green, Green/Black, Violet, Violet/Black wires, which are used for a four-speaker installation, are not used. The ends of these wires must be covered with electrical tape to prevent them from shorting to the unit or the vehicle chassis.

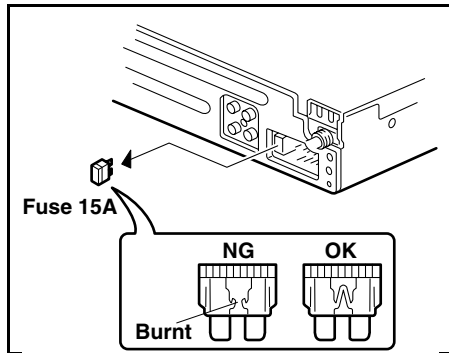

- When using a two-speaker installation, set the FADER control to the center position.
- When fuse replacement is necessary remove the blown fuse by using pliers. Then install the new 15 amp. fuse.

LINE OUT/CD CHANGER CONNECTIONS

- The unit has a built-in CD changer controller and line output terminals. You can use a compatible Sanyo CD changer and a separate amplifier to upgrade your system.

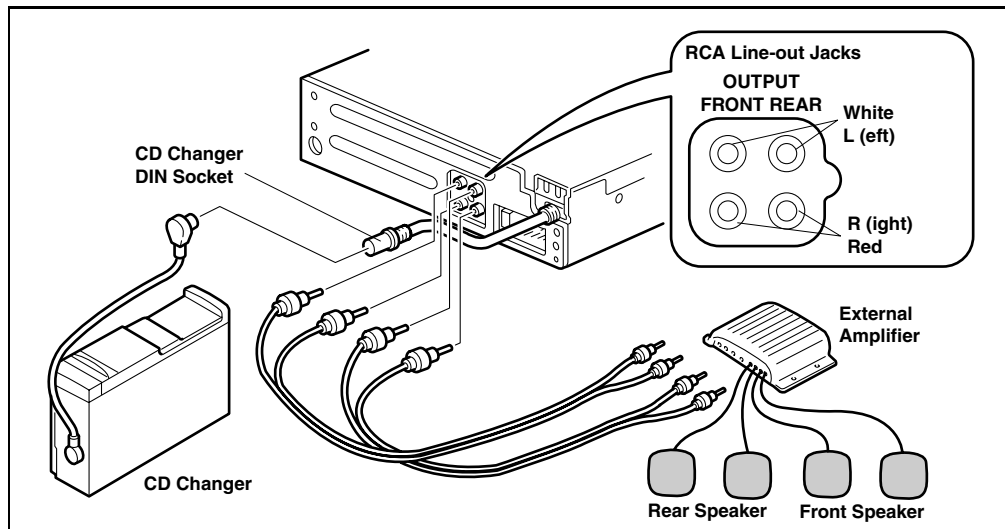

CD Changer DIN Socket

- Connect the 8-pin DIN cable, which is supplied with the compatible Sanyo CD changer, to the DIN socket on the back of the unit.

RCA Line-out Jacks (For Speakers)

- Connect a patch cable (not supplied) from the White (left channel) and Red (right channel) RCA line output jacks to the line input terminals of the external amplifier.

SPECIFICATION

FM TUNER SECTION

Frequency Range	87.5MHz–107.9MHz
Usable Sensitivity	15dBf
50dB Quieting Sensitivity	30dBf
Frequency Response (± 3 dB)	.50Hz–12.5kHz
I.F. Rejection	100dB
Image Rejection	.65dB
Signal-to-Noise Ratio	.60dB
Selectivity	.65dB
Stereo Separation	.27dB
Capture Ratio	.2dB
Antenna Impedance	75 Ω

AM TUNER SECTION

Frequency Range	530kHz–1710kHz
Usable Sensitivity (S/N 20dB)	20 μ V
I.F. Rejection	.80dB
Image Rejection	.75dB
S/N Ratio	.50dB
Antenna Impedance	75 Ω

TAPE SECTION

Wow and Flutter	.01%
S/N Ratio (Normal)	.52dB
Separation	.50dB
Frequency Response	50Hz–15kHz

CD SECTION

Disc size	5"
Channels	2-channel stereo
Sampling Frequency	44.1kHz
D/A Converter	Twin, 1-bit
Pickup	Optical 3-beam semiconductor laser
Digital Filter	4 fs
Frequency Response	20Hz–20kHz
Total Harmonic Distortion	0.1% (1 kHz)
Dynamic Range	.85dB
Signal-to-Noise Ratio	.90dB
Wow and Flutter	Below measurable limits
Channel Separation (1kHz)	.85dB

AUDIO SECTION

RMS Power Rating (3% THD)	20W \times 4 (14.4 V)
RMS Power Rating (10% THD)	24W \times 4 (14.4 V)
Maximum Output Power	.50W \times 4CH (15.5 V)
Load Impedance	4 Ω

GENERAL

Operating Voltage	12V (10.5–15.5 V)
Operating Current Maximum	13A

IMPORTANT INFORMATION

Because its products are subject to continuous improvement, SANYO reserves the right to modify product designs and specifications without notice and without incurring any obligation.



Printed in Malaysia

21605 Plummer Street
Chatsworth, CA91311

1ED6P10A18800
Rev.0

Free Manuals Download Website

<http://myh66.com>

<http://usermanuals.us>

<http://www.somanuals.com>

<http://www.4manuals.cc>

<http://www.manual-lib.com>

<http://www.404manual.com>

<http://www.luxmanual.com>

<http://aubethermostatmanual.com>

Golf course search by state

<http://golfingnear.com>

Email search by domain

<http://emailbydomain.com>

Auto manuals search

<http://auto.somanuals.com>

TV manuals search

<http://tv.somanuals.com>