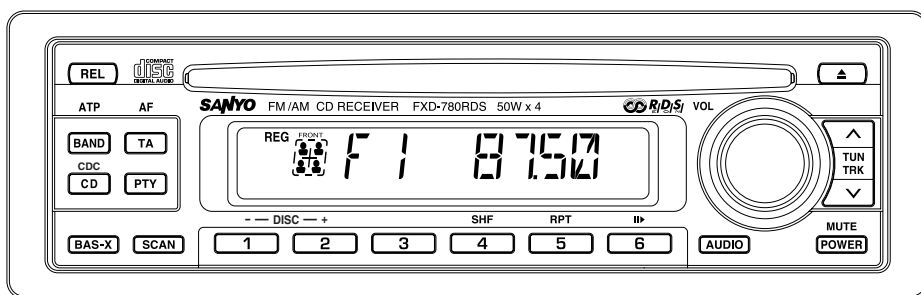

FXD-780RDS

 with CD Changer Control

Full Panel Detachable
High Power FM/AM Stereo Receiver
Compact Disc Player with CD Changer Controller
ISO Mounting with Removable Trim Ring

OPERATING INSTRUCTIONS 1~24

CONTENTS

COMPACT DISC CARE	2
DIGITAL DISPLAY	3
DETACHABLE FRONT PANEL	4
GENERAL OPERATION	5
RADIO OPERATION	9
RDS OPERATION	11
CD OPERATION	14
CD CHANGER OPERATION	16
ERROR SIGNS	18
HINTS FOR PROPER AND SAFE OPERATION	19
TROUBLESHOOTING	20
ACCESSORIES AND HARDWARE	21
UNIT REMOVAL	22
ELECTRICAL CONNECTIONS	23
LINE OUT CONNECTIONS	24

CAUTION

- This unit is designed to operate on 12 volts DC, **NEGATIVE** ground electrical systems only.
- When fuse replacement is necessary, use only a 10 amp fuse. Do not replace with a higher rated fuse. If the fuse blows often, carefully check all electrical connections for any short circuits and have your car's voltage regulator checked also.
- Do not install the unit where it will be exposed to direct sunlight or hot air discharged from the car heater.
- Do not expose the unit to water or moisture.
- To avoid damaging the unit, never insert anything other than a compact disc into the disc slot.
- This unit should not be adjusted or repaired by anyone except qualified service personnel. If servicing is required, return the unit to an authorized SANYO mobile audio dealer.
- Use the Controls or adjustments or performance of procedures other than those specified herein may result in hazardous radiation exposure.
- Changes or modifications not expressly approved by SANYO may void the user's authority to operate this equipment.

COMPACT DISC CARE

Dirt, dust, scratches and warpage can cause a deterioration in the sound or intermittent skipping some tracks during play.



- This unit has been designed to play compact discs bearing the identification logo shown on the left. No other discs can be played.



- Do not use non-conventional discs such as heart-shaped, octagonal discs, etc. The player could be damaged.

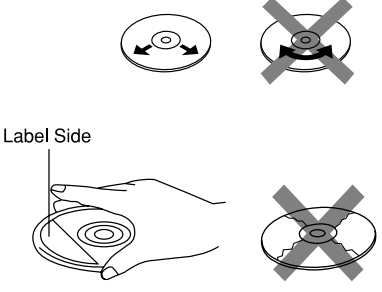

- Fingerprints and dust should be carefully wiped off the signal surface of the disc (glossy side) with a soft cloth. Wipe in a straight motion from the inside to the outside of the disc. Unlike conventional records, the compact disc has no grooves to collect dust and debris. Small dust particles will have no effect on reproduction quality.
- Do not insert a disc which is cracked into the unit.
- Do not apply paper or write anything on the surface of the disc.



- To prevent warping the disc, do not expose it to direct sunlight, high humidity or high temperatures for extended periods of time.



Benzene Thinner Cleaning spray

- Never use chemicals such as record cleaning sprays, antistatic sprays or fluids, benzene or thinner to clean compact discs. These chemicals will permanently damage the plastic surface of the disc.
- When not using the disc player for extended periods of time, remove the compact disc and return it to the plastic storage case. This will protect the disc from dust and exposure to the sun.

Recommended CD-R Media

Data may not be properly written to CD-R media depending on the quality of the media. If this happens, the data may not be reproduced correctly. We recommend the following manufacturers to insure proper quality of the media.

CD-R Media

TDK USA Corp., Taiyo Yuden (U.S.A.), Inc., Ricoh Corporation, Eastman Kodak Company, Maxell Corporation of America, Mitsubishi Chemical Corporation, Fuji Photo Film U.S.A., Inc., Mitsui Chemicals, Inc., Sony Corporation of America, Philips Electronics North America Corporation, Imation Corp.

Additionally, CD-R media compatible with various speeds such as 2X and 1X-4X are available. Please refer to the instruction manuals of the drive and the recording software you are using to selection of the correct media.

DIGITAL DISPLAY

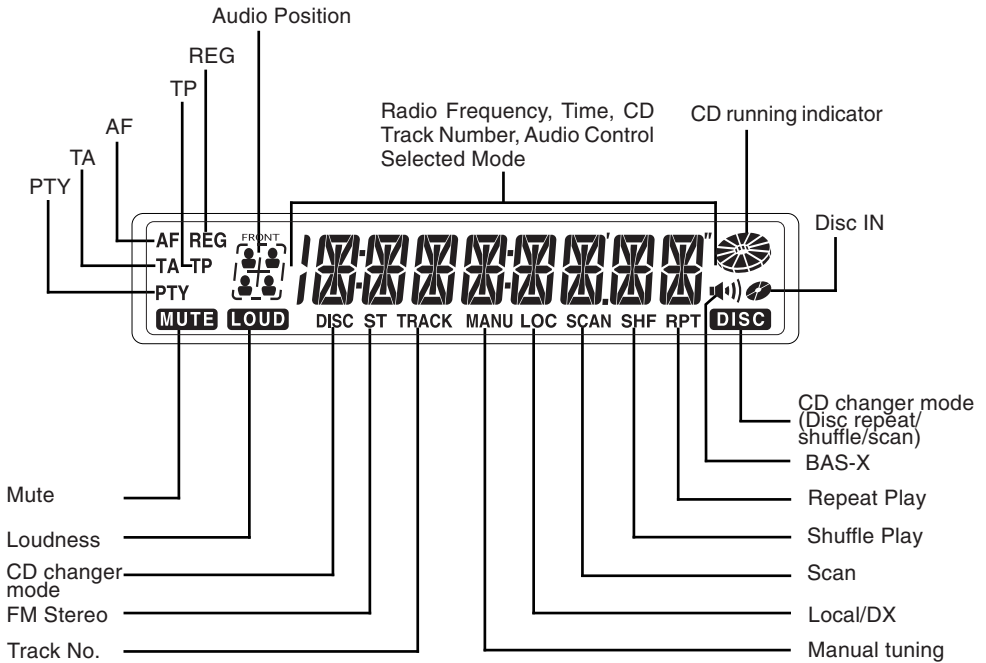

DETACHABLE FRONT PANEL

The front panel is designed to be removable for antitheft purposes. It is recommended that you remove and carry the front panel with you when you leave your car.

HOW TO ATTACH THE FRONT PANEL

Align the right side of the panel with the stopper, and then push the left side of the panel into the unit until it clicks.

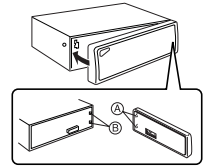

HOW TO DETACH THE FRONT PANEL

Press the release button (REL) to release the front panel. Pull the entire panel to remove it from the unit.

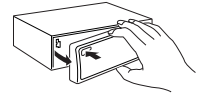

RETURNING TO THE INITIAL SETTINGS

When the eject button is pressed for more than 10 seconds, the micro-computer of the unit returns to the initial settings. If the display window is not properly shown or the unit malfunctions, press the eject button for more than 10 seconds.

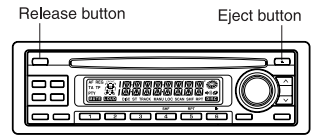

Note

The unit will not operate if it is installed incorrectly.

⚠ CAUTION

- Do not attempt to remove the panel in a manner other than that described above.
- When installing the panel, do not force it into the unit.
- Do not touch the connection terminals of the panel or the unit. It may cause poor contact.
- Use a clean, dry cloth when cleaning the terminals.
- Keep the panel out of direct sunlight and high temperatures.
- Prevent the panel from coming into contact with benzene, thinner, or insecticides.
- Do not drop the panel.

SECURITY INDICATOR

When the front panel is detached, you can find an RED indicator on the front side of the unit. This indicator is designed to deter theft, and continues to flash. This unit is not equipped with any other security systems such as a security alarm, so there are limitations to its effectiveness.

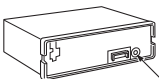

Security system indicator

GENERAL OPERATION

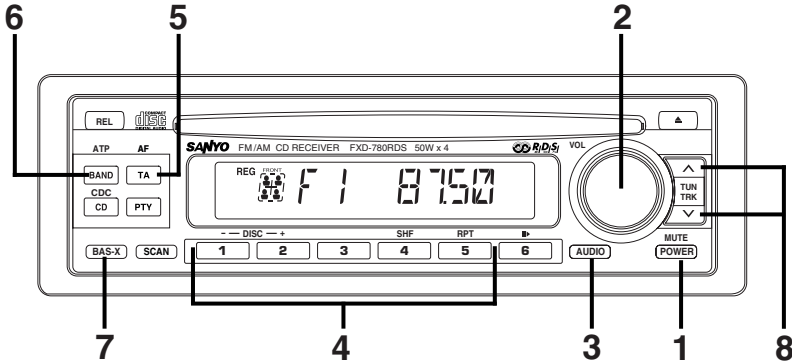

TURNING THE POWER ON 1

Install the front panel and press the PWR MUTE button 1 when ACC is on.

TURNING THE POWER OFF 1

Press the PWR MUTE button for more than 2 seconds. Display will revert to clock indication.

VOLUME LEVEL CONTROL 2

Rotate the VOL dial 2 to adjust the volume level.

MUTING THE SOUND 1

Press the PWR MUTE button 1 while the receiver is on. While muting the sound, the MUTE indicator **MUTE** on the display is blinking. To restore the previous volume level, press PWR MUTE button again.

SETTING THE CLOCK 3, 2, 6, 8

The clock uses a 24-hour display system.

1. Press the AUDIO button 3 for more than 2 seconds.

2. Press the following buttons to set the clock.

VOL dial 2 : Adjust the hour and minutes.

TUN/TRK ^ 8 : To activate Hour blink.

TUN/TRK v 8 : To activate Minute blink.

BAND ATP 6 : Adjust the minutes to zero.

(Example) 12:29 → 12:00

12:30 → 13:00

3. Press the AUDIO button 3 to activate the clock.

CT(Clock Time) select 5

Press the TA AF button 5 while the clock indicator flashes in order to select or deselect the CT if so desired. (The CT function is initially set to ON when shipped)

The CT function of the RDS enables the built-in clock in the unit to automatically synchronize with the CT data. When you select "CT ON", the clock is automatically adjusted to the local time transmitted by an RDS station.

Notes

- The CT function may not work even though an RDS station.
- The time set by the CT function may not be accurate.

SWITCHING THE DISPLAY 3

Each time you press the AUDIO button 3, the item changes as follows ;

Initial set

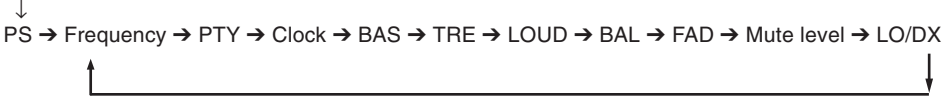

DISPLAY PRIORITY SELECTOR 3

You can adjust with which priority items are to be displayed. Display priority can be set for the following four items ;

- PS (Programme Service name)
- Frequency
- PTY (Programme Type)
- Clock

Press the AUDIO button 3 until your requested item being displayed, then hold the AUDIO button 3 pressed for more than 2 seconds (Beep tone will be heard) to set priority to the item.

ADJUSTING THE SOUND CHARACTERISTICS 2, 3

1. Each time you press the AUDIO button 3 until the desired mode is displayed.
2. Rotate the VOL dial 2 to adjust the selected item. Make the adjustment within 5 seconds after selecting. After 5 seconds, the display window will revert to display priority.
 - MUTE LEVEL controls the volume level used when the sound is muted. You can adjust the level by the volume is reduced from the previous volume level.

Adjustment Range

BASS (BAS 0)	BAS -5	BAS +5
TREBLE (TRE 0)	TRE -5	TRE +5
LOUDNESS (LOUD OFF)	LOUD ON	LOUD OFF
BALANCE (L 0:R 0)	BAL L9 R0 (Full left)	BAL L0 R9 (Full right)
FADER (R 0:F 0)	FAD R0 F9 (Full front)	FAD R9 F0 (Full rear)
MUTE LEVEL (MUTE -20)	MUTE - 0	MUTE -80
Local/DX(SENS DX)	SENS DX	SENS LO

LOUDNESS EFFECT

When listening to music at low volume levels, this feature will boost the extremes of the bass and treble ranges to compensate for the negative characteristics of human hearing.

LOCAL/DISTANT(LO/DX) SELECTION





This feature is used to select the strength of the signals at which the radio will stop during Automatic Tuning. Select the Local (LO) setting and only the strongest (local) stations will be received. The "LOC" indicator appears in the display window.

Select the Distant setting and the radio will stop at a wider range of signals, including weaker more distant stations. The "LOC" indicator will go out on the display window.

ENHANCING THE BASS SOUND (BAS-X)..... 7

Press the BAS-X button 7 to display the BAS-X INDICATOR () on the display window.

Each time you press the BAS-X button 7, current mode appears on the display window and the mode change as follows.

(No display)	BAS-X 0 (No BASS enhanced)
↓	
	BAS-X 1 (Enhanced BASS level : LOW)
↓	
	BAS-X 2 (Enhanced BASS level : Middle)
↓	
	BAS-X 3 (Enhanced BASS level : High)
↓	
	BAS-X 4 (Enhanced BASS level : Very high)

Note

Settings for BASS, TREBLE, LOUDNESS and BAS-X can be made to each of the following modes independently: FM, AM, and CD.

ADJUSTING THE SOUND STAGE 4

You can adjust the position of sound stage to best serve a particular seat.

TO MEMORY THE SOUND STAGE 4

1. Adjust the BALANCE & FADER.
2. Press the appropriate Preset buttons 4 for more than 2 seconds. The balance & fader indicator blinks and adjusted sound stage is stored.

TO CALL THE SOUND STAGE 4

Press the appropriate Preset buttons 4 to call the desired sound stage during the BALANCE & FADER adjustment mode. The Preset buttons are factory-set to the following conditions.

		BALANCE	FADER
P 1		(L0 R2)	(R4 F0)
P 2		(L0 R0)	(R4 F0)
P 3		(L2 R0)	(R4 F0)
P 4		(L0 R0)	(R0 F4)
P 5		(L0 R0)	(R0 F0)

Each time you press the Preset buttons 4 in the BALANCE & FADER adjustment mode, the audio position indicator changes as follows ;

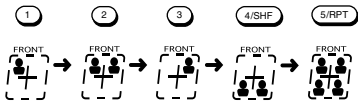

TEL MUTE FUNCTION

Shut down the audio system temporarily whenever an incoming call is received.

When the telephone rings:

When a call is received, “TEL–MUTE” is displayed and all the unit functions are temporarily interrupted.

Turning TEL Mute Function Off After Phone Call:

Hang the phone up.

“TEL–MUTE” disappears from the display window. The original source (i.e., the one used before the phone call) is returned to automatically, and the volume restored.

Note

The function will not work if a cable is not connected to the car phone.

IGNITION-OFF CLOCK RECALL 3

Press the AUDIO button 3 while the ignition switch is in the “OFF” position.

The display will illuminate showing the time and then automatically shut off after 5 seconds.

RADIO OPERATION

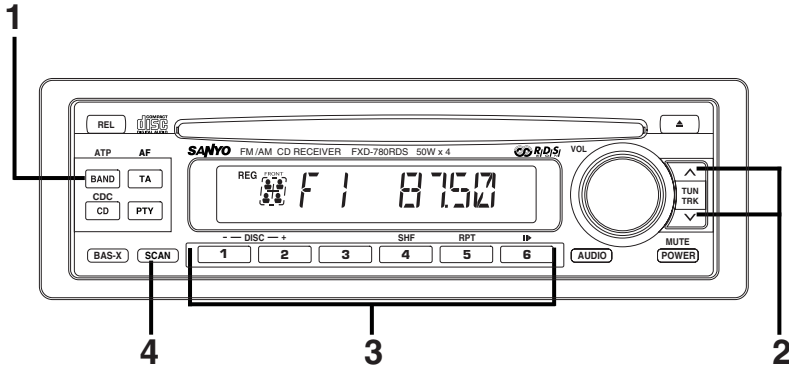

SELECTING RADIO MODE

Press the BAND ATP button 1 to switch from CD mode to the radio mode. Each time the BAND ATP button is pressed, the selected band changes as shown below.

FM 1(F 1) → FM 2(F 2) → FM 3(F 3) → AM 1(A 1) → AM 2(A 2)



RADIO TUNING 2

- Automatic tuning Press the TUN/TRK \wedge or \vee Button 2.
When the button is pressed, the system will start automatic tuning and stop at the next receivable station.
- Manual tuning To select higher frequency station, press the TUN/TRK \wedge button for more than 0.5 seconds. The "MANU" indicator appears in the display window. To select lower frequency stations, press the TUN/TRK \vee button for more than 0.5 seconds. To quickly scan up or down in frequency, press and hold the TUN/TRK \wedge or \vee button. Release the button when the display approaches the desired frequency, then press and release the button repeatedly until the desired frequency is displayed. After 4 seconds of completing Manual Tuning, the tuning control will revert to the Automatic Tuning mode.

STORING PRESET STATIONS 3

The preset buttons 3 can be used to store 6 stations in each band (FM 1, FM 2, FM 3 and AM 1, AM 2) for convenient access to your favorite stations.

- Programming stations 1. Select the desired band, then tune in the station you want to store in memory.
2. Press and hold one of the preset buttons 3 for more than 2 seconds until the frequency indicator flashes twice. Repeat steps 1. and 2. to program additional stations.
- Quick tuning Select the desired band, then press one of the 6 preset buttons 3.

ATP (AUTO TRAVEL PRESET) OPERATION 1

The Auto Travel Preset function searches for and memorizes the 6 strong stations in one of the two bands (FM 3, AM 2) in order of signal strength.

This feature is useful when you are driving in an unfamiliar location and want to memorize local stations without changing the standard preset stations.

A total of 12 stations (6 FM and 6 AM) can be programmed.

- To set the stations Select the desired band. Press and hold the BAND ATP button 1 for more than 2 seconds.
- Quick tuning of ATP stations Select the desired band, then press one of the 6 preset buttons 3.

Note

This function is available for FM 3 and AM 2.

SCAN OPERATION 4

- 1.** Press the BAND ATP button 1 to select the desired band.
- 2.** Press the SCAN button 4. The system will select and receive each station for 10 seconds.
- 3.** To stop scanning and retain the station currently selected, press the SCAN button 4 again.

PRESET SCAN OPERATION 4

This function scans each of the preset stations stored in the selected band (both manual preset and auto travel presets).

- 1.** Press the BAND ATP button 1 to select the desired band.
- 2.** Press the SCAN button 4 for more than 2 seconds. The system will select and receive each preset station for 10 seconds.
- 3.** To stop scanning and retain the station currently selected, press the SCAN button 4 again.

RDS OPERATION

Radio Data System (RDS) is a digital information system that sends additional digital information along with the regular FM radio programme signal. As soon as a radio station has been identified, the station name, including a regional identifier if applicable, will appear in the display window, for example SWF4MZ (local radio station of Rhein hassen, Germany). This is also one of the RDS functions. Your car stereo offers you more convenience when receiving FM stations with RDS.

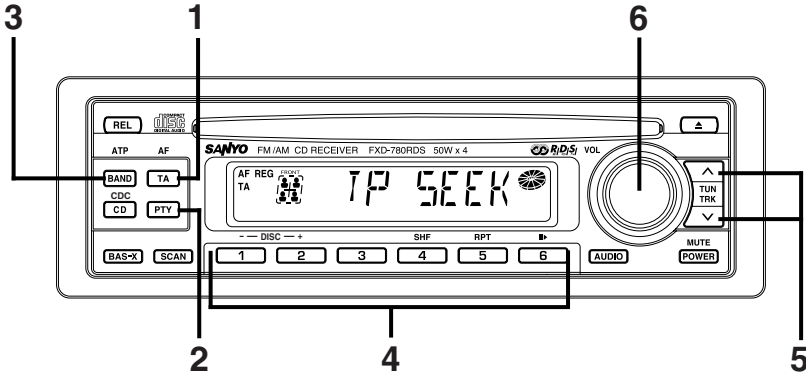

CHANGING THE DISPLAYED ITEMS

SELECTING AF MODE 1

Hold the TA AF button 1 for more than 2 seconds to display “AF” indicator in the display window. Press again for more than 2 seconds to cancel this feature.

AF : The unit will automatically tune to a frequency offering better reception of the same RDS programme. Seek tuning in the AF mode causes the unit to receive RDS stations only, with “RDS SEEK” appearing in the display window.

SELECTING TA MODE 1

Press the TAAAF button 1 to display “TA” indicator in the display window. Press again to cancel this feature.

TA : The unit will only play stations offering traffic announcements. Seek tuning in the TA mode causes the unit to receive traffic information only, with “TP SEEK” appearing in the display window.

Notes

- In the AF mode, “NO ALTERNATIVE FREQUENCY AVAILABLE” appears in the display window when the unit receives a weak signal and fails to find an alternative station.
- In the TA mode, the display window shows “NO TRAFFIC INFO AVAILABLE” when the unit does not receive any traffic information.
- In the AF mode, “PI SEEK” appears on the display window when the unit fails to find any RDS stations after you press the preset button for predefined RDS stations. In this case, the unit will automatically seek the same programme corresponding to a preset station.

AUTOMATIC RE-TUNING 1,3,5

The Alternative Frequencies (AF) function automatically selects and tune to the station with the strongest signal in a network. By using this function, you can continuously listen to the same programme during a long-distance drive without having to re-tune the station manually.

- 1.** Press the BAND ATP button 3 to select the FM band.
- 2.** Hold the TA AF button 1 for more than 2 seconds to display the “AF” indicator in the display window.
- 3.** Press the TUN/TRK \wedge or \vee buttons 5 to tune in to a desired RDS station includes the AF data, the units starts searching for an alternative station with a stronger signal in the same network.

SELECTING REG ON OR REG OFF 2

Hold the PTY button 2 for more than 2 seconds to select REG OFF. The “REG” indicator will go out in the display window.

Hold the PTY button 2 again for more than 2 seconds to select REG ON. (There may be cases where this function may not be activated in some areas, especially in the United Kingdom)

- REG ON** : The tuner remains tuned to the current regional programmes.
REG OFF : The tuner may tune to another regional programme in the network.

RECEIVING TRAFFIC ANNOUNCEMENTS 1,3

The Traffic Announcement (TA) and Traffic Programme (TP) data allows the radio to automatically tune in to an FM station which broadcasts traffic announcements while you are listening to other programme sources.

- 1.** Press the BAND ATP button 3 to select the FM band.
- 2.** Press the TA AF button 1 to display the “TA” indicator in the display window. Press the TA AF button again to cancel.
You can listen to traffic announcements by using the Automatic or Manual tuning. “TP” appears in the display window when the unit receives an RDS station broadcasting traffic announcements.
During reception of a traffic announcement, the “TA” indicator flashes in the display window. Then press the TAAF button 1 to cancel Traffic announcement (but still in TA mode). To cancel the TA mode, press the TA AF button 1 again during NO-reception of a traffic announcement.

PRESETTING THE VOLUME OF TRAFFIC ANNOUNCEMENTS 6

You can preset the volume level of the traffic announcements.
When a traffic announcement starts, the volume will be automatically adjusted to the preset level.
Rotate the VOL dial 6 to adjust to the desired volume level during reception of the traffic announcements.

LOCATING A STATION WITH PTY2,4,5,6

You can locate the station you want to listen to by selecting one of the programmes from the following table.

Programme types	Display	Programme types	Display
News	NEWS	Weather	WEATHER
Current Affairs	AFFAIRS	Finance	FINANCE
Information	INFO	Children's programme	CHILDREN
Sport	SPORT	Social Affairs	SOCIAL
Education	EDUCATE	Religion	RELIGION
Drama	DRAMA	Phone In	PHONE IN
Culture	CULTURE	Travel	TRAVEL
Science	SCIENCE	Leisure	LEISURE
Varied	VARIED	Jazz Music	JAZZ
Pop music	POP M	Country Music	COUNTRY
Rock music	ROCK M	National Music	NATION M
Easy Listening Music	EASY M	Oldies Music	OLDIES
Light classical	LIGHT M	Folk Music	FOLK M
Serious classical	CLASSICS	Documentary	DOCUMENT
Other music	OTHER M		

1. Press the PTY button 2 to display the last selected PTY by user.
2. Select your requested PTY in the PTY table using the VOL dial 6. PTY memorized in the Preset button (1 - 6) 4 can be called directly.
 The Preset buttons are factory-set to the following type of programmes.
 P 1 : POP-M P 2 : ROCK-M P 3 : CLASSICS
 P 4 : JAZZ P 5 : VARIED P 6 : NEWS
 Then press the TUN/TRK \wedge and \vee buttons 5 to search the PTY you want to listen.
3. In case the PTY you want to listen can not be found, it is back to the station received before PTY searched, and display, for instance "NO" and "SPORT" mutually on the display window in case your requested PTY is Sport.
4. In order to memorize PTY in the Preset, select PTY you want to memorize with VOL dial 6 then hold the Preset button (1 - 6) 4 pressed for 2 seconds.

Notes

- The RDS function may not work properly in the area where the signal strength is weak.
- Depending on the country or region, not all of the RDS functions are available.

CD OPERATION

The compact disc player will accept 5" CD only.

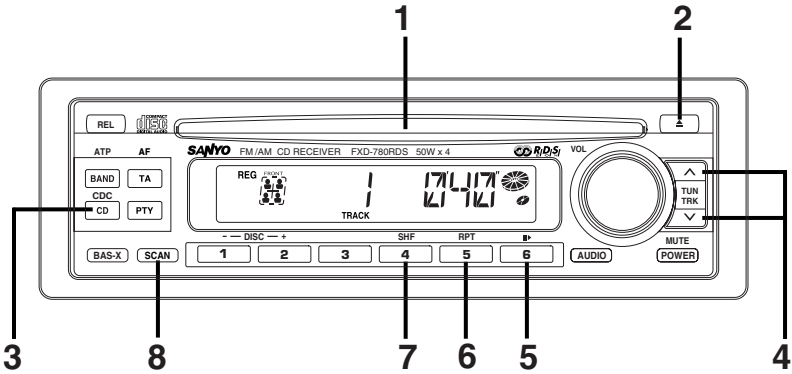

LOADING AND EJECTING THE CD

Insert a disc into the CD slot 1 and the CD player will start. The system remains in CD mode and “CD” appears in the display window. Press the eject button 2 to eject a disc.

SWITCHING TO CD MODE 3

Press the CD button 3 with the power on to switch from radio mode to CD mode. When the CD mode is switched on while a disc is loaded, play resumes from the point at which play was stopped. When the entire disc has played, the unit returns to the first track and play resumes. The CD player continues playing the disc until the BAND ATP button is pressed, or the disc is ejected.

SKIPPING TRACKS 4

Press the TUN/TRK \wedge button 4 to skip to the beginning of the next track. Press the TUN/TRK \vee button 4 to skip to the beginning of the track currently playing. Press the TUN/TRK \vee button 4 twice to skip to the beginning of the previous track. Press and hold the TUN/TRK \wedge or \vee button 4 for more than 0.5 seconds to search quickly (with sound) in the forward or reverse direction. When the button is released, the CD resumes normal play.

Notes

- Some CD-Rs (depending on the equipment used for its recording or the condition of the disc) may not play on this unit.
- You cannot play CD-R that is not finalized. (A finalize process necessary for a recorded CD-R disc to be played on the audio CD player.)
- You cannot play CD-RWs (rewritable CDs) on this unit.

PLACING THE CD IN PAUSE MODE 5

While playing a CD, press the Preset 6 button 5.
To resume playing, press the Preset 6 button again.

Notes

- *During playback of a CD, the CD running indicator  spins.*
- *The unit will turn-on automatically when a CD is inserted if the ignition switch is "ON".*

REPEAT MODE 6

Press the Preset 5 (RPT) button 6 to play the current track repeatedly.
The "RPT" indicator appears in the display window.
To cancel this mode, press the Preset 5 (RPT) button 6 again.

SHUFFLE MODE 7

This function plays the tracks on a CD in random order.
Press the Preset 4 (SHF) button 7 to begin shuffle play.
The "SHF" indicator appears in the display window.
Press the \wedge button 4 to select another random track.
To cancel this mode, press the Preset 4 (SHF) button 7 again.

SCAN MODE (PLAYING THE BEGINNING OF EACH TRACK) 8

This function plays the first 10 seconds of each track sequentially.
Press the SCAN button 8 to begin the scan mode.
The "SCAN" indicator appears in the display window.
To cancel this mode, press the SCAN button 8 again.

CD CHANGER OPERATION

The unit can be used to control the functions of the CD Changer. Please check with your nearest dealer for recommendations of the models that will work with this unit.

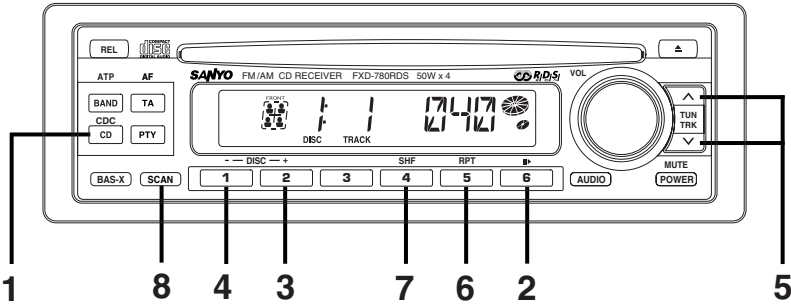

SELECTING CD CHANGER MODE 1

Press the CD button 1 until the Disc No, Track No, and Track time appears on the display panel. Press the CD button 1 again to change back to radio or CD operation.

PUTTING THE CD IN PAUSE MODE 2

While playing a CD, press the Pause button 2 to place the changer in the pause mode. To resume playing, press the Pause button 2 again.

SELECTING A DISC 3,4

Press the DISC + button 3 to select the next disc.
Press the DISC - button 4 to select the preceding disc.

SKIPPING TRACKS 5

Press the TUN/TRK button ^ to skip to the beginning of the next track.
Press the TUN/TRK button v to skip to the beginning of the track currently playing.
Press the TUN/TRK button v twice to skip to the beginning of the previous track.
Press and hold the TUN/TRK button ^ or v for more than 0.5 seconds to search quickly (with sound) in the forward or reverse direction. When the button is released, the CD resumes normal play.

REPEAT MODE 6

- Repeat tracks ; Press the RPT button 6 to play the current track repeatedly. "RPT" indicator appears in the display window.
- Repeat discs ; Press the RPT button 6 for more than 2 seconds to play the current disc repeatedly. "RPT" and "**DISC**" appears in the display window.

To cancel the track repeat or disc repeat mode, press the RPT button 6 again.
The system will remain in this mode until it is cancelled.

SHUFFLE MODE 7

This function plays the tracks on one CD or all CDs in the magazine in random order.

- "Shuffle-playing" tracks ; Press the SHF button 7 to play the current disc in random order. "SHF" indicator appears in the display window.
- "Shuffle-playing" discs ; Press the SHF button 7 for more than 2 seconds. "SHF" and "**DISC**" appears in the display window. The system selects a disc at random and plays all tracks on that disc. When all tracks have been played, the next disc is selected and "Shuffle-play" is repeated.

To cancel the track shuffle or disc shuffle mode, press the SHF button 7 again.
The system will remain in this mode until it is cancelled.

SCAN MODE (PLAYING THE BEGINNING OF TRACKS OR DISCS) 8

This function plays the first 10 seconds of each track or disc sequentially.

- Playing the beginning of tracks(Track Scan) ; Press the SCAN button 8 to play the first 10 seconds of each track on the current disc in order. "SCAN" indicator appears in the display window.
- Playing the beginning of discs(Disc Scan) ; Press the SCAN button 8 for more than 2 seconds to play the first 10 seconds of each disc in the magazine. "SCAN" and "**DISC**" appears in the display window.

To cancel the track scan or disc scan mode, press SCAN button 8 again.

ERROR SIGNS

If a problem should occur while operating the CD player, one of the following error signs may be displayed. Refer to the table below to identify the problem, then take the suggested corrective action. If the error persists, contact your nearest dealer.

Message	Cause	Remedy
CD ERROR	Dirty disc. Scratched disc. Up-side-down.	Clean the disc. Replace the disc. Check the disc.
	Focus error.	Try ejecting and re-inserting under normal temperature conditions.
	Data and focus error.	Under normal temperature conditions, eject and insert clean, undamaged disc properly.
MECK ERR.	Mechanical problem.	Eject and re-insert.

ERROR SIGNS (CD changer)

If a problem should occur while operating the CD changer, one of the following error signs may be displayed. Refer to the table below to identify the problem, then take the suggested corrective action. If the error persists or "MECA ERR" and "09 ERROR" appears, contact your nearest dealer.

Message	Cause	Remedy
NO MAGA NO DISC	No magazine. No disc.	Load the magazine in the CD changer. Check the disc.
CD ERROR	Up-side-down.	Check the disc.
COMM ERR	Communication error	Check the connection of the CD changer.
TEMP ERR	Excessive temperature conditions at the CD changer.	The error sign will go off and play will resume when the temperature at the CD changer returns to a normal range.

HINTS FOR PROPER AND SAFE OPERATION

- **Condensation**

Moisture can condense on the optical lens of the CD player during humid or rainy days, or after the car heater is turned on. If this occurs the disc player may not function properly. To remedy the situation, remove the disc from the unit and wait approximately one hour. This should allow the moisture to evaporate and restore normal operation.

- **Temperature Consideration**

The unit may not operate correctly in extremely hot or cold temperatures. Avoid exposing the unit to extremely high or low temperatures.

- **Interruptions in the sound (skipping)**

When the car is driven on very rough surfaces, the sound from the CD player may skip and be interrupted. This will not cause any damage to the disc or the player. If this occurs, wait for the road surface to improve before using the CD player.

- **Safety**

For safer driving, keep the volume at a moderate level to enable you to hear outside sounds (such as emergency vehicle sirens).

- **Cleaning the unit**

Clean the unit with a soft, dry cloth. Stains should be removed by wiping the surfaces with a soft cloth immersed in lukewarm water and wrung dry. Never use strong chemicals or solvents. These will damage the finish of the unit.

- **Disc care**

When not using the disc player for extended periods, remove the compact disc and return it to the plastic storage case. Do not leave a disc partially ejected from the player. If an ejected disc remains in the loading slot for approximately 10 seconds, the player will reload the disc to prevent damage.

- **Servicing**

Should a problem develop, do not open the unit or try to repair it yourself. If servicing is required, bring the unit to a Sanyo Authorized Service Center.

TROUBLESHOOTING

Sometimes a simple operational error or a mistake in the wiring can appear to be a problem with the unit. Before having the unit serviced, refer to the troubleshooting chart below.

Symptom	Cause	Solution
The compact disc does not play when inserted into the unit.	The volume control is turned down.	Turn up the volume control.
	The power connections are not wired correctly.	Check the +12V and ground connections.
No power.	The vehicle ignition is switched off.	Switch the ignition to the "ON" or "ACC" position.
	The fuse is blown.	Replace the fuse with another 10A fuse.
The unit does not work properly (Eject, Load, Play)	The microcomputer has been affected by electrical noise.	Eject the disc, then insert it again.
The sound from the CD player skips.	The road surface is rough.	Wait for the road surface to improve before playing a disc.
	The unit is not mounted securely.	Install the unit securely. Be sure to use the rear strap if the vehicle does not provide support for the rear of the unit. (See page 22)
	The disc is defective.	Try another disc. If it plays properly, the first disc may be defective.
	The disc is dirty.	Clean the disc as explained on page 2.
No radio reception.	The antenna cable is not connected.	Insert the antenna cable firmly into the antenna jack on the unit.
The radio does not stop on any stations when automatic tuning is used.	The signal are weak.	Select a station using manual tuning.

ACCESSORIES AND HARDWARE

INSTALLATION

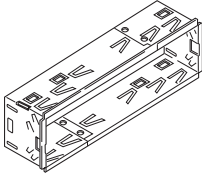

Mounting Bracket
(Half Sleeve) × 1

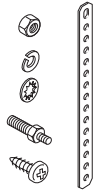

Mounting Strap
and Screws × 1



Locking Screw
× 1

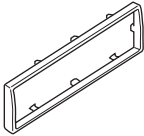

Removable Trim Ring
× 1

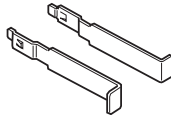

Unlock Levers
× 2

INSTALLATION

1. BEFORE INSTALLATION

When mounting the unit in a car, keep the unit as level as possible.

If the unit must be mounted at an angle, due to the design of the vehicle, make sure the unit does not tilt by more than 30°.

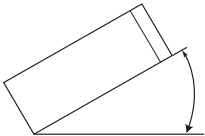

max. 30°

2. INSTALLATION PROCEDURES

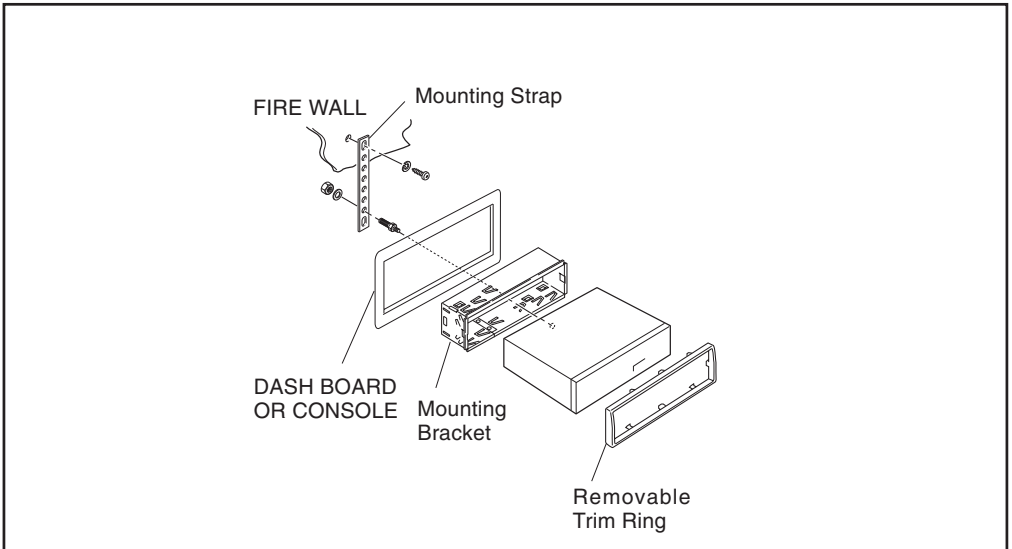

When mounting the unit into a DIN-standard cutout (182 × 53 mm) in the dashboard or console, attach the provided Removable Trim Ring to the unit.

1. Insert the mounting bracket into the DIN-standard cutout (182 × 53 mm) in the dashboard or console.
2. Bend the mounting bracket stopper outward until the bracket fits snugly in the cutout.
3. Attaching the Mounting Strap to the underside of the dash board, using screw. Attach the back of the unit to the Mounting Strap using support stem bolt and hardware.

UNIT REMOVAL

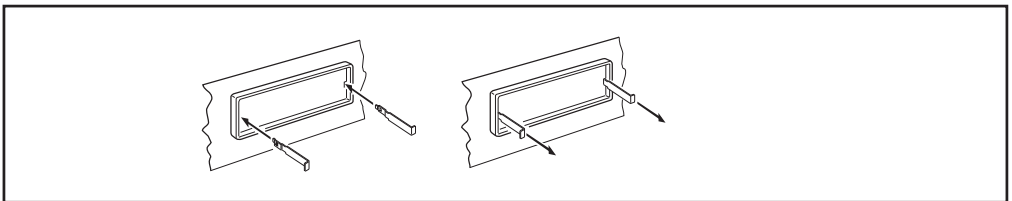

1. Insert the unlock levers into the slots on each side of the unit until they click into place.
2. Pull the levers to remove the unit.

Notes

- Handle the unlock levers carefully to avoid injuring your fingers.
- Keep the unlock levers in a safe place for future use.

ELECTRICAL CONNECTIONS

WIRING

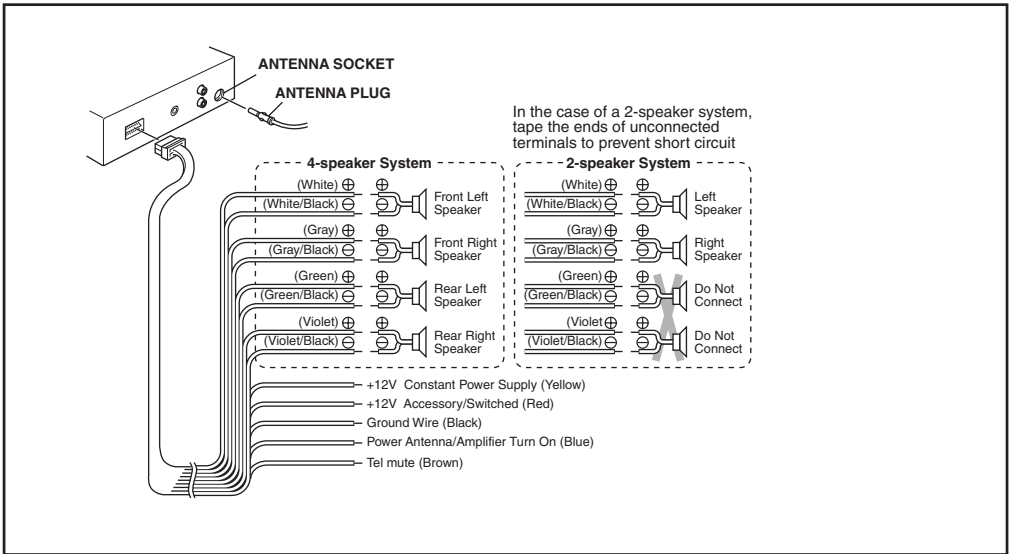

⚠ CAUTION

- DO NOT connect any speaker wires to the metal body or chassis of the vehicle.
- DO NOT connect the speaker common (–) wires to each other.
- Connect each speaker wire directly to each speaker terminal.
- All speaker common (–) wires must remain floating.

1 Antenna socket

- Insert the plug from the antenna installed in your vehicle into this socket. (If your vehicle has a dual antenna system, a dual antenna to single antenna cable adaptor may be required.)

2 + 12V Constant Power Supply (Yellow)

- Connect this wire to the +12V power terminal which receives power continuously.

3 +12V Accessory/Switched (Red)

- Connect this wire to the terminal which receives power while the ignition switch is ON or in the ACCESSORY position.

4 Ground wire (Black)

- Connect this wire to the vehicle chassis.

5 Power Antenna/Amplifier Turn On (Blue)

- Connect this wire to the control terminal of a Power Antenna or an external amplifier.
- When not using a Power Antenna or an external amplifier, this wire is not connected.

6 Tel mute (Brown)

- Connect to the terminal that is grounded when either the telephone rings or during conversation.

Notes

- When using a two-speaker installation, the Green, Green/Black, Violet, Violet/Black wires, which are used for a four-speaker installation, are not used. The ends of these wires must be covered with electrical tape to prevent them from shorting to the unit or the vehicle chassis.
- When using a two-speaker installation, set the FADER control to the center position.

REPLACING THE FUSE

When fuse replacement is necessary remove the blown fuse by using pliers. Then install the new 10 amp. fuse.

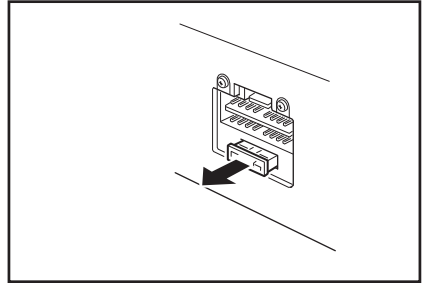

LINE OUT CONNECTIONS

- The unit has a built-in CD changer controller and line out terminals. You can use a compatible Sanyo CD changer and a separate rear channel amplifier to upgrade your system.

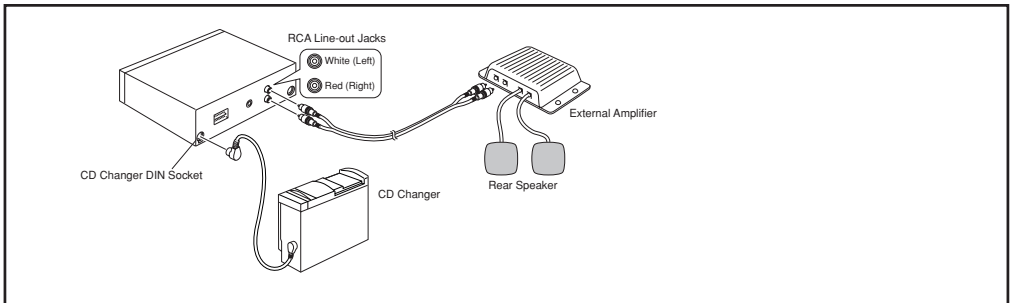

CD Changer DIN Socket

- Connect the 8-pin DIN cable, which is supplied with the compatible Sanyo CD changer, to the DIN socket on the back of the unit.

RCA Line- out Jacks (For Rear Speakers)

- Connect a patch cable (not supplied) from the White (left rear channel) and Red (right rear channel) RCA line output jacks to the line input terminals of the external amplifier.

SANYO Electric Co., Ltd.
Printed in Singapore
Issue date 08-02
288F0630

Free Manuals Download Website

<http://myh66.com>

<http://usermanuals.us>

<http://www.somanuals.com>

<http://www.4manuals.cc>

<http://www.manual-lib.com>

<http://www.404manual.com>

<http://www.luxmanual.com>

<http://aubethermostatmanual.com>

Golf course search by state

<http://golfingnear.com>

Email search by domain

<http://emailbydomain.com>

Auto manuals search

<http://auto.somanuals.com>

TV manuals search

<http://tv.somanuals.com>