

## INSTRUCTION MANUAL

### Color Video Monitor

## VMC-8618 VMC-8620

### CONTENTS

INFORMATION TO USER .....	1
PRECAUTION .....	3
PARTS NAMES .....	4
CONNECTIONS .....	5
BASIC OPERATION .....	6
ADJUST THE OSD MENU ITEM .....	7
TROUBLESHOOTING .....	9
SPECIFICATIONS .....	10

### FEATURES

- **Equipped with video and audio input terminals**  
The video and audio input terminals (two systems for each input) allow bridge connections.
- **Equipped with Y/C input (S-VIDEO input) terminal**  
This terminal is used to input Y/C separation signals (S-VIDEO signals).
- **Eight languages OSD MENU**  
ENGLISH, FRANCAIS, DEUTSCH, ESPAÑOL, ITALIANO, RUSSIAN, CHINESE, JAPANESE
- **Horizontal resolution**  
More than 800 TV lines (VMC-8618)  
More than 450 TV lines (VMC-8620)
- **PAL/NTSC color system, selected automatically**
- **Built-in speaker**
- **Multi voltage (100 – 240 V)**

### ACCESSORY

- **AC power cord (Re-attachable)**





#### About this manual

- Before installing and using this unit, please read this manual carefully. Be sure to keep it handy for later reference.
- This manual gives basic connections and operating instructions for 2 models.



# INFORMATION TO USER

## WARNING:

TO REDUCE THE RISK OF FIRE OR ELECTRIC SHOCK, DO NOT EXPOSE THIS PRODUCT TO RAIN OR MOISTURE.  
DO NOT INSERT ANY METALLIC OBJECT THROUGH THE VENTILATION GRILLS.

	<b>CAUTION</b> RISK OF ELECTRIC SHOCK DO NOT OPEN	
<b>CAUTION:</b> TO REDUCE THE RISK OF ELECTRIC SHOCK. DO NOT REMOVE COVER (OR BACK). NO USER-SERVICEABLE PARTS INSIDE. REFER SERVICING TO QUALIFIED SERVICE PERSONNEL.		

## Explanation of graphical Symbols

	The lightning flash with arrowhead symbol, within an equilateral triangle, is intended to alert the user to the presence of uninsulated "dangerous voltage" within the product's enclosure that may be of sufficient magnitude to constitute a risk of electric shock to persons.
	The exclamation point within an equilateral triangle is intended to alert the user to the presence of important operating and maintenance (servicing) instructions in the literature accompanying the product.

## FCC COMPLIANCE STATEMENT

**FCC INFORMATION:** THIS EQUIPMENT HAS BEEN TESTED AND FOUND TO COMPLY WITH THE LIMITS FOR A CLASS A DIGITAL DEVICE, PURSUANT TO PART 15 OF THE FCC RULES. THESE LIMITS ARE DESIGNED TO PROVIDE REASONABLE PROTECTION AGAINST HARMFUL INTERFERENCE WHEN THE EQUIPMENT IS OPERATED IN A COMMERCIAL ENVIRONMENT. THIS EQUIPMENT GENERATES, USES, AND CAN RADIATE RADIO FREQUENCY ENERGY AND IF NOT INSTALLED AND USED IN ACCORDANCE WITH THE INSTRUCTION MANUAL, MAY CAUSE HARMFUL INTERFERENCE TO RADIO COMMUNICATIONS. OPERATION OF THIS EQUIPMENT IN A RESIDENTIAL AREA IS LIKELY TO CAUSE HARMFUL INTERFERENCE IN WHICH CASE THE USER WILL BE REQUIRED TO CORRECT THE INTERFERENCE AT HIS OWN EXPENSE.

**CAUTION:** CHANGES OR MODIFICATIONS NOT EXPRESSLY APPROVED BY THE PARTY RESPONSIBLE FOR COMPLIANCE COULD VOID THE USER'S AUTHORITY TO OPERATE THE EQUIPMENT.

THIS CLASS A DIGITAL APPARATUS MEETS ALL REQUIREMENTS OF THE CANADIAN INTERFERENCE-CAUSING EQUIPMENT REGULATIONS.

CET APPAREIL NUMÉRIQUE DE LA CLASSE A RESPECTE TOUTES LES EXIGENCES DU RÈGLEMENT CANADIEN SUR LE MATÉRIEL CAUSANT DES INTERFÉRENCES.

# IMPORTANT SAFEGUARDS

1. **READ INSTRUCTIONS** -- All the safety and operating instructions should be read before the appliance is operated.
2. **RETAIN INSTRUCTIONS** -- The safety and operating instructions should be retained for future reference.
3. **CLEANING** -- Unplug video monitor or equipment from the wall outlet before cleaning. Do not use liquid cleaners or aerosol cleaners. Use a damp cloth for cleaning.
4. **ATTACHMENT** -- Do not use attachments not recommended by the video monitor or equipment manufacturer as they may result in the risk of fire, electric shock or injury to persons.
5. **WATER AND MOISTURE** -- Do not use the video monitor or equipment near water -- for example, near a bathtub, washbowl, kitchen sink, laundry tub, in a wet basement, or near a swimming pool, or the like.
6. **ACCESSORIES** -- Do not place video monitor or equipment on an unstable cart, stand or table. The video monitor or equipment may fall, causing serious injury to a child or adult, and serious damage to the equipment. Wall or shelf mounting should follow the manufacturer's instructions, and should use a mounting kit approved by the manufacturer.
- 6A. Video monitor or equipment and cart combinations should be moved with care. Quick stops, excessive force, and uneven surfaces may cause the equipment and cart combination to overturn. 
7. **VENTILATION** -- Slots and openings in the cabinet and the back or bottom are provided for ventilation, and to ensure reliable operation of the video monitor or equipment and to protect it from overheating. These openings must not be blocked or covered. The openings should never be blocked by placing the video monitor or equipment on a bed, sofa, rug, or other similar surface. Video monitor or equipment should never be placed near or over a radiator or heat register. Video monitor or equipment receiver should not be placed in a built-in installation such as a bookcase unless proper ventilation is provided.
8. **POWER SOURCES** -- Video monitor or equipment should be operated only from the type of power source indicated on the marking label. If you are not sure of the type of power supplied to your home, consult your video monitor or equipment dealer or local power company. For video monitor or equipment designed to operate from battery power refer to the operating instructions.
9. **GROUNDING OR POLARIZATION** -- This product is equipped with a three-wire grounding-type plug, a plug having a third (grounding) pin. This plug will only fit into a grounding-type power outlet. This is a safety feature. If you are unable to insert the plug into the outlet, contact your electrician to replace your obsolete outlet. Do not defeat the safety purpose of the grounding-type plug.
10. **POWER CORDS** -- Do not allow anything to rest on the power cord. Do not locate video monitor or equipment where the cord will be abused by persons walking on it.
11. **HEED WARNINGS** -- Follow all instructions marked on the video monitor or equipment.
12. **LIGHTNING** -- For added protection for video monitor or equipment during a lightning storm, or when it is left unattended and unused for long periods of time, unplug it from the wall outlet and disconnect the antenna or cable system. This will prevent damage to the video product due to lightning and power-line surges.
13. **OVERLOADING** -- Do not overload wall outlets and extension cords as this can result in a risk of fire or electric shock.
14. **OBJECT AND LIQUID ENTRY** -- Never push objects of any kind into video monitor or equipment through openings as they may touch dangerous voltage points or short-out parts that could result in a fire or electric shock. Never spill liquid of any kind on the product.
15. **SERVICING** -- Do not attempt to service video monitor or equipment yourself as opening or removing covers may expose you to dangerous voltage or other hazards. Refer all servicing to qualified service personnel.
16. **DAMAGE REQUIRING SERVICE** -- Unplug video monitor or equipment from the wall outlet and refer servicing to qualified service personnel under the following conditions.
  - A. When the power-supply cord or the plug has been damaged.
  - B. If liquid has spilled, or objects have fallen into the video product.
  - C. If the video product has been exposed to rain or water.
  - D. If the video product does not operate normally by following the operating instructions, adjust only those controls that are covered by the operating instructions as an improper adjustment of other controls may result in damage and will often require extensive work by a qualified technician to restore the video product to its normal operation.
  - E. If the video product has been dropped, or the cabinet damaged.
  - F. When the video product exhibits a distinct change in performance -- this indicates a need for service.
17. **REPLACEMENT PARTS** -- When replacement parts are required, be sure the service technician has used replacement parts specified by the manufacturer or that have the same characteristics as the original parts. Unauthorized substitutions may result in fire, electric shock or other hazards.
18. **SAFETY CHECK** -- Upon completion of any service or repairs to this video product, ask the service technician to perform safety checks to determine that the video product is in proper operating condition.

# PRECAUTION

If an abnormality does occur, turn the power switch off and unplug the unit. Have a qualified technician perform any repairs.

**Do not use the monitor if it makes a strange noise, emits a strange odor, or if smoke comes out from it**

If used under these conditions, the monitor may cause a fire or electric shock. Immediately unplug it and wait to make sure no more smoke comes from it. Then take it to the dealer for service. Do not try to repair or open the monitor yourself.

**Do not allow the power cord to get damaged**

- Do not place heavy objects on the power cord.
- Do not place the power cord near a heat source.
- Do not excessively bend the power cord, modify it, or secure it with staples.

Doing so may damage the power cord and cause a fire or electric shock.

If the power cord is damaged, take it to the dealer and have it replaced.

**Do not allow dust or dirt to build up on the power cord or power outlet**

A build-up of dust may cause a short circuit or generate heat and cause a fire.

Be especially careful when using the monitor in areas of high humidity, in areas with frequent condensation, in kitchens, and in places where there is excessive dust.

Periodically unplug the power cord and clean away the dust that builds up between the plug terminals.

**Cautions when plugging in the power cord**

- Make sure you insert the plug of the power cord all the way in the power outlet. Using the monitor with the power cord not fully plugged in may cause heat to generate and cause a fire.
- Do not use the monitor with the power cord wound or tied up. Heat may generate and cause a fire.
- When using an extension cord, be sure that the total current load of all equipment connected to it does not exceed the specified ratings of the extension cord. If the ratings are exceeded, heat may generate and cause a fire. Make sure to carefully read the specifications accompanying the extension cord.

**Cleaning**

- Dirt can be removed from the cabinet by wiping it with a soft cloth. To remove stains, wipe with a soft cloth moistened with a soft detergent solution and wrung dry, then wipe dry with dry soft cloth.
- Do not use benzine, thinner or other chemical product on the cabinet, as that may cause deformation and paint peeling. Before using a chemical cloth, make sure to read all accompanying instructions. Make sure that no plastic or rubber material comes in contact with the cabinet for a long period of time, as that may cause damage or paint peeling.

**SERVICE**

This unit is a precision instruments and if treated with care, will provide years of satisfactory performance. However, in the event of a problem, the owner is advised not to attempt to make repairs or open the cabinet. Servicing should always be referred to your dealer or Sanyo Authorized Service Centre.

# PARTS NAMES

## Front Panel

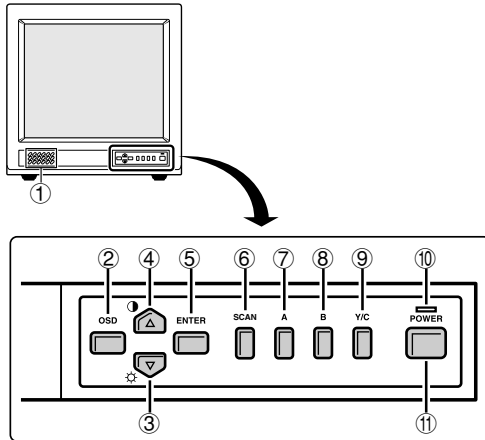

- ① **Speaker**  
When the monitor selector button (A, B or Y/C) is pressed, the speaker lets you hear the sound from the unit which is connected to the audio input terminals at the rear of the monitor.
- ② **On-screen display button (OSD)**  
When this button is pressed, the menu screen appears on the monitor screen.
- ③ **Cursor (▼) button (☺)**  
When this button is pressed, the cursor moves down. When it reaches the bottom, it reappears at the top. In addition, this button is used to make adjustment values smaller.
- ④ **Cursor (▲) button (☹)**  
When this button is pressed, the cursor moves up. When it reaches the top, it reappears at the bottom. In addition, this button is used to make adjustment values larger.
- ⑤ **Display selector button (ENTER)**  
If this button is pressed while a picture is on the monitor screen, the screen changes to the adjustment screen. If the button is pressed once more, the picture returns to the previous screen.
- ⑥ **Underscan/overscan select button (SCAN)**  
The initial setting is for the normal screen (overscan). If the SCAN button is pressed, the screen will become smaller (underscan) than the normal screen. Change this setting in cases such as when screen display characters are missing. If the **SCAN** button is pressed once more, the normal screen is displayed again.
- ⑦ **Monitor A selector button (A)**  
When this button is pressed, the audio and video input changes to the unit which is connected to the A terminals at the rear of the monitor.
- ⑧ **Monitor B selector button (B)**  
When this button is pressed, the audio and video input changes to the unit which is connected to the B terminals at the rear of the monitor.
- ⑨ **Monitor Y/C selector button (Y/C)**  
When this button is pressed, the audio and video input changes to the unit which is connected to the Y/C terminals at the rear of the monitor.
- ⑩ **Power indicator (POWER)**  
Lights when the power is on.
- ⑪ **Power button (POWER)**  
Press this button to turn the power on and off.

## Rear Panel

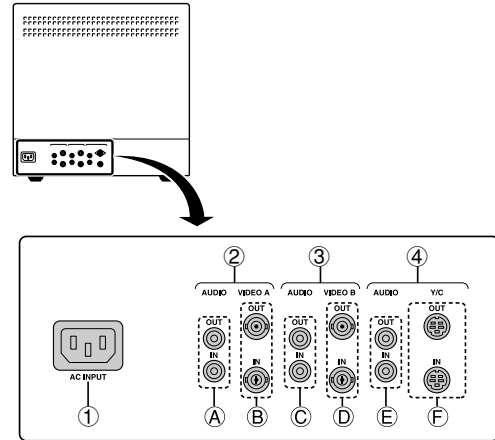

- ① **AC INPUT socket**  
Connect the AC power cord (supplied) securely to this socket and to a wall outlet.
  - ② **Rear A terminals (AUDIO/VIDEO A terminals)**  
When the monitor A selector button at the front of the monitor is pressed, the audio and video signals from the unit which is connected to these terminals can be monitored.
    - Ⓐ AUDIO OUT/IN terminals
    - Ⓑ VIDEO OUT/IN terminals
  - ③ **Rear B terminals (AUDIO/VIDEO B terminals)**  
When the monitor B selector button at the front of the monitor is pressed, the audio and video signals from the unit which is connected to these terminals can be monitored.
    - Ⓒ AUDIO OUT/IN terminals
    - Ⓓ VIDEO OUT/IN terminals
  - ④ **Rear Y/C terminals (AUDIO/VIDEO Y/C terminals)**  
When the monitor Y/C selector button at the front of the monitor is pressed, the audio and video signals from the unit which is connected to these terminals can be monitored.
    - Ⓔ AUDIO OUT/IN terminals
    - Ⓕ S-VIDEO OUT/IN terminals
- Note:** If there is no signal being input from the input terminals selected (A, B or Y/C) at the rear of the monitor, "NO SIGNAL" will be displayed.

# CONNECTIONS

Before making any connection, make sure all the devices are turned off.

Before making the connections, please refer to the instruction manual accompanying each device. If the devices are not connected properly, that may cause a fire and/or damages.

## Basic connections

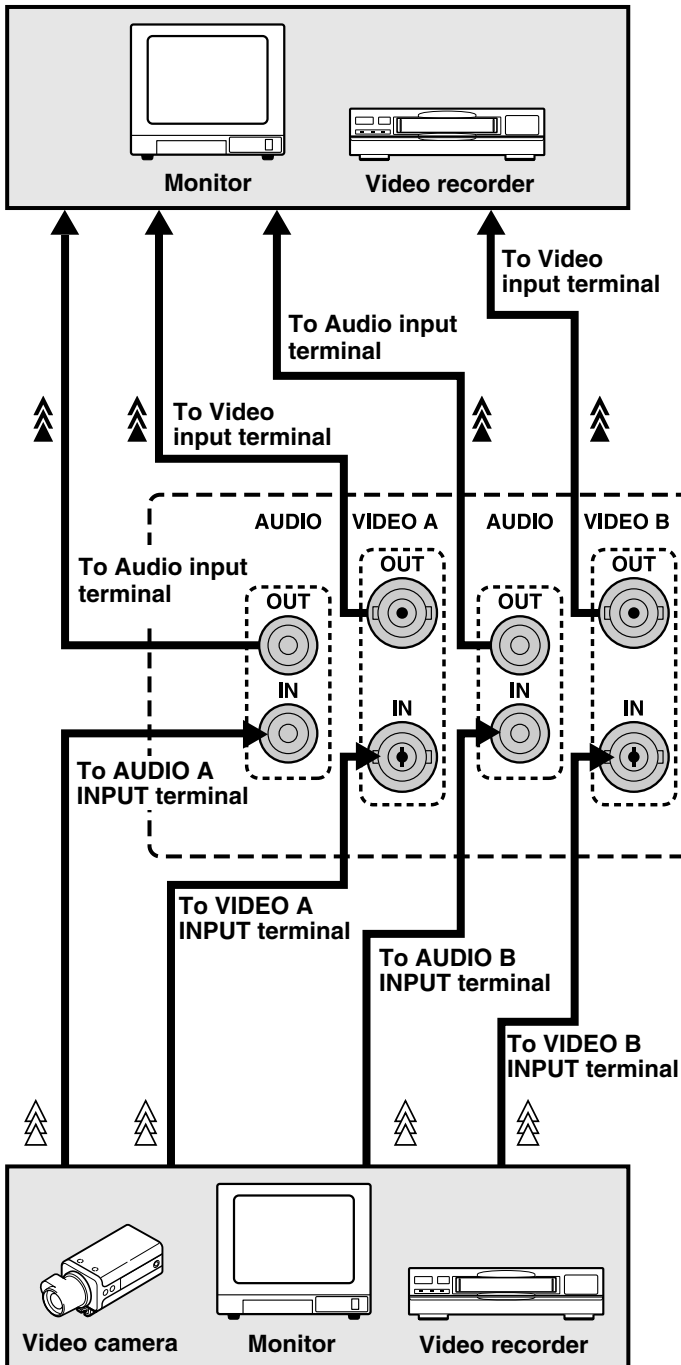

## Connections to the S-VIDEO terminals

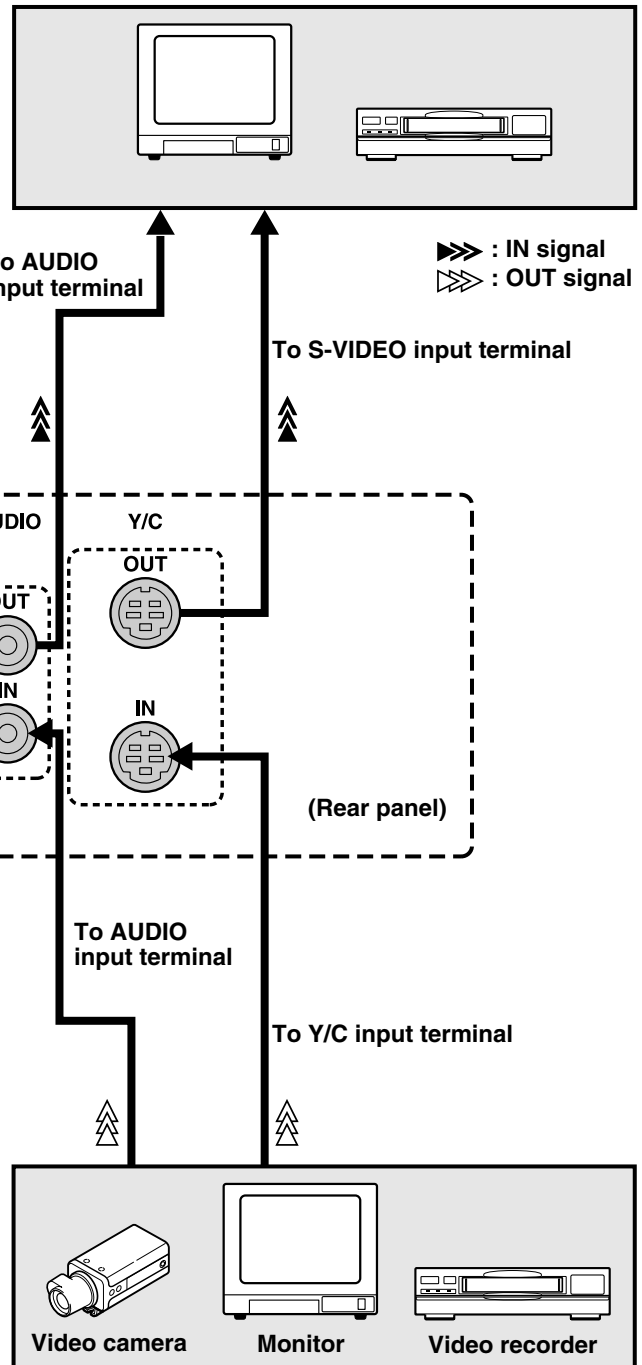

### Note:

- The components and connection cables are not included and must be purchased separately.
- If connecting a single component, it can be connected to either the A or B terminals at the rear of the monitor.

# BASIC OPERATION

## 1 Press the POWER button to turn on the power.

**ON:** The power is turned on (the POWER indicator is lit).  
The signals from the channel (A, B or Y/C) which was being used when the power was last turned off will be input.

**OFF:** The power is turned off (the POWER indicator is off).

**Note:** If the power for the connected components is not turned on, or if a problem with operation has occurred, "VIDEO LOSS" will appear on the screen. If this happens, check the component concerned.

## 2 Select the audio and video input.

Use the monitor selector buttons (A or B) at the front of the monitor to select the picture being input to either the A or B terminals at the rear of the monitor.

If using the S-VIDEO input terminal at the rear of the monitor, press the monitor Y/C selector button.

**Note:** If there is no signal being input from the input terminals selected (A, B or Y/C) at the rear of the monitor, "NO SIGNAL" will be displayed.

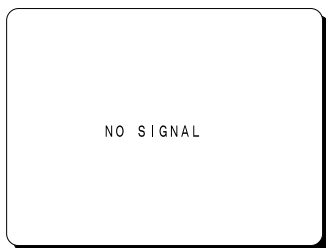

## 3 Menu screen operations

### 1 Press the OSD button.

The menu screen will be displayed.

The menu screen will only be displayed for about 13 seconds.

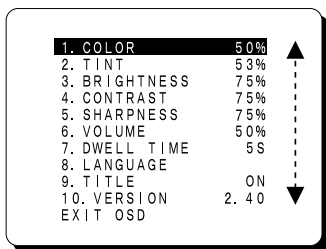

### 2 Press the cursor (▼) or (▲) button.

The cursor will move up or down, so that you can select the desired menu item.

**To return to the normal monitor screen**

- Press the **OSD** button once more, or
- Select "**EXIT: OSD**" and then press the **ENTER** button.

### 3 Select the desired menu item and then press the ENTER button.

If you press the **ENTER** button repeatedly while the menu screen is being displayed, the display will alternately change between the menu screen and the setting screen. At this time, the menu item will still be selected.

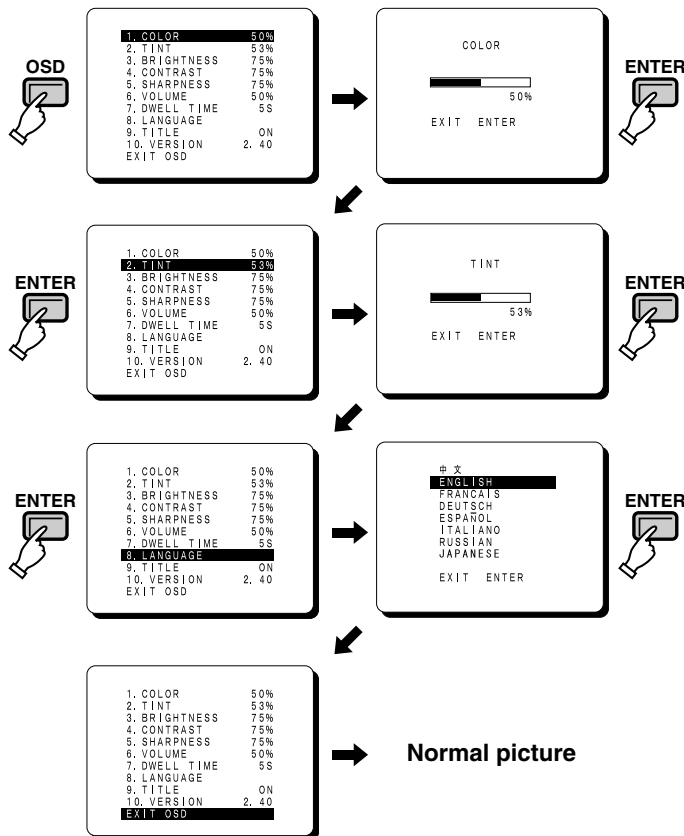

**Note:** During this operation, "9. TITLE" and "10. VERSION" will be skipped and the screen will go straight to "EXT: OSD".

# ADJUST THE OSD MENU ITEM

Open the menu screen (press the **OSD** button), use the cursor buttons to select the desired menu item, and then press the **ENTER** button.

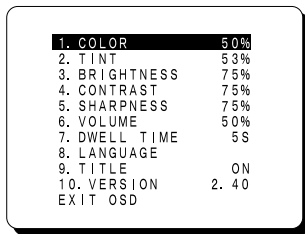

**Note:** The setting characters which are displayed on each adjustment screen (such as 50%) may not display correctly (dropout) in some cases.

## ■ COLOR adjustment

- 1 Select "1. COLOR 50%" and then press the **ENTER** button.
- 2 Use the cursor (**▼**) and (**▲**) buttons to adjust the color of the picture.

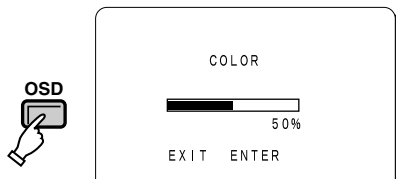

## ■ TINT adjustment

- 1 Select "2. TINT 53%" and then press the **ENTER** button.
- 2 Use the cursor (**▼**) and (**▲**) buttons to adjust the tint of the picture (NTSC only).

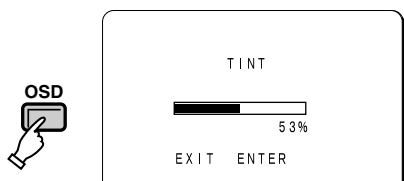

## ■ BRIGHTNESS adjustment

- 1 Select "3. BRIGHTNESS 75%" and then press the **ENTER** button.
- 2 Use the cursor (**▼**) and (**▲**) buttons to adjust the brightness of the picture.

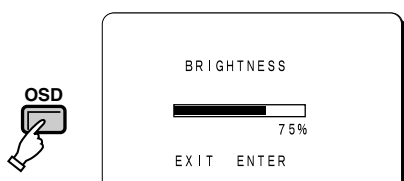

## ■ CONTRAST adjustment

- 1 Select "4. CONTRAST 75%" and then press the **ENTER** button.
- 2 Use the cursor (**▼**) and (**▲**) buttons to adjust the contrast of the picture.

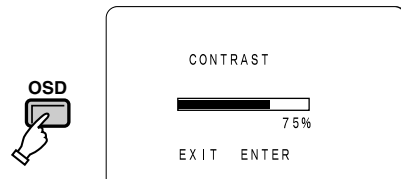

## ■ SHARPNESS adjustment

- 1 Select "5. SHARPNESS 75%" and then press the **ENTER** button.
- 2 Use the cursor (**▼**) and (**▲**) buttons to adjust the sharpness of the picture.



## ■ VOLUME adjustment

- 1 Select "6. VOLUME 50%" and then press the **ENTER** button.
- 2 Use the cursor (**▼**) and (**▲**) buttons to adjust the sound volume.

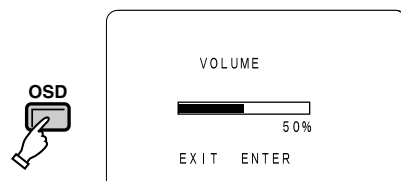

- **Monitor switching time (dwell time) setting**  
It is not available.



# ADJUST THE OSD MENU ITEM

## Menu screen language setting

- 1 Select "8. LANGUAGE" and then press the ENTER button.
- 2 Use the cursor (▼) and (▲) buttons to select the display language.
  - Only the menu screen and setting screen languages will be changed.

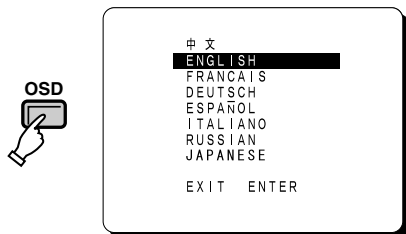

## Displaying characters such as for setting location on the monitor screen

**Note:** If there is no signal being input from the input terminals selected (A, B or Y/C) at the rear of the monitor, the title cannot be set for those terminals.

- 1 Select "9. TITLE ON" and then press the ENTER button.

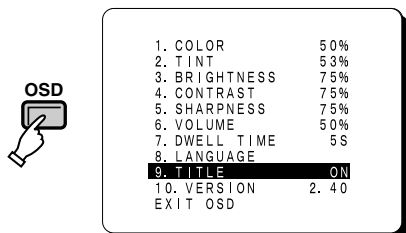

- 2 To display "ABCD" on the CH B monitor as an example:

A maximum of eight characters can be displayed on the screen.

**Note:** The setting screen will disappear after approximately 13 seconds of no activity.

1. Use the cursor (▼) button to select "CH B".

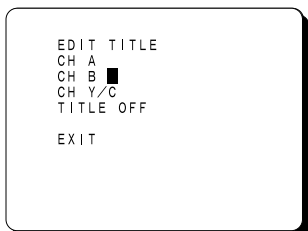

2. Press the ENTER button, and then use the cursor ▼ (▲) button to select "A".

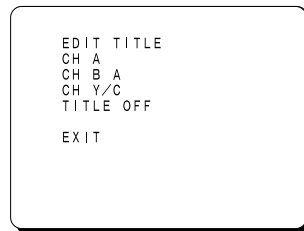

3. Press the ENTER button, and then use the cursor ▼ (▲) button to select "B".
4. Press the ENTER button, and then use the cursor ▼ (▲) button to select "C".
5. Press the ENTER button, and then use the cursor ▼ (▲) button to select "D".

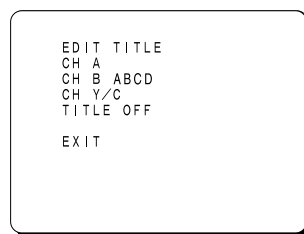

6. Press the OSD button.

The cursor will move to the next monitor display.

The settings for the CH A and CH Y/C monitors can be carried out by the same procedure as described above.

- 3 Use the cursor ▼ (▲) button to select "TITLE ON", and then press the ENTER button.

The text that has been set for that monitor screen will then be displayed.

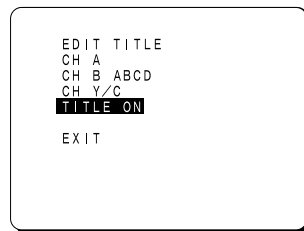

# TROUBLESHOOTING

Solutions to common problems related to your monitor are describe here. If none of the solutions presented here solve the problem, unplug the monitor and consult a SANYO-authorized dealer or service center for assistance.

Problems	Points to be checked	Measures (Remedy)	Page
<b>No picture with the power on</b>	Is the video signal being output from the connected component?	Set the connected component correctly.	<b>5</b>
	Is the input signal selected properly?	Select the required video signal input with the monitor selector buttons. (A, B and Y/C)	<b>3</b>
<b>No sound.</b>	Is the audio signal being output from the connected component?	Set the connected component correctly.	<b>5</b>
	Is the volume set to the minimum level?	Adjust the volume using the VOLUME setting screen.	<b>7</b>
	Is the audio cable disconnected?	Securely connect the audio cable.	<b>5</b>
<b>Shaking picture</b>	Is the monitor close to a device which is generating a strong magnetic field?	Move the device away from the monitor until the picture stabilizes.	–
<b>No color, color is incorrect or picture is too dark</b>	Have the picture control settings (CONTRAST, BRIGHTNESS, TINT) been changed?	Adjust the settings using the adjustment screens.	<b>7</b>
<b>Uneven or mismatched color in parts of the picture</b>	Are there any speakers or magnets nearby, or were they brought close to the monitor?	Move the speaker or magnet away from the monitor, and then turn the power off and wait at least 30 minutes before turning the power back on again.	–

# SPECIFICATIONS

	VMC-8618	VMC-8620
<b>Color system</b>	PAL/NTSC, selected automatically	
<b>Picture tube</b>	18 inch	20 inch
<b>Resolution</b>	More than 800 TV lines	More than 450 TV lines
<b>Input terminals</b>		
<b>S-VIDEO signal (VIDEO C)</b>	Separate Y/C signal, mini-DIN connector (1) Y signal: 1.0 Vp-p, 75 Ω negative sync C signal: 0.286 Vp-p, 75 Ω negative sync, bridge connection possible	
<b>Video signal (VIDEO A, B)</b>	Composite sync signal, 1.0 Vp-p, 75 Ω BNC connector (2)	
<b>Audio signal (AUDIO A, B)</b>	-6 dBs (400 mVrms), RCA pin (3), bridge connection possible	
<b>Output terminals</b>		
<b>S-VIDEO signal (VIDEO C)</b>	Separate Y/C signal, mini-DIN connector (1) Y signal: 1.0 Vp-p, 75 Ω negative sync C signal: 0.286 Vp-p, 75 Ω negative sync, bridge connection possible	
<b>Video signal (VIDEO A, B)</b>	Composite sync signal, 1.0 Vp-p, 75 Ω BNC connector (2), automatic termination setting	
<b>Audio signal (AUDIO A, B)</b>	-6 dBs (400 mVrms), RCA pin (3), bridge connection possible	
<b>Menu screen items</b>		
<b>Picture adjustment</b>	Adjustable COLOR, TINT (NTSC only), BRIGHTNESS, CONTRAST, SHARPNESS	
<b>Sound adjustment</b>	Adjustable speaker volume	
<b>Language setting</b>	Eight languages (English, Francais, Deutsch, Espanol, Italiano, Russian Chinese and Japanese)	
<b>Title setting</b>	Title entry up to [eight] alphanumeric characters	
<b>Overscan or underscan selection</b>	YES	
<b>Speaker</b>	x1, impedance of 8 Ω	
<b>Audio output</b>	1 W	
<b>Power source</b>	100 ~ 240 V AC, 50/60 Hz	
<b>Power consumption</b>	95 W	
<b>Ambient operating temperature</b>	-10 ~ +45°C, storage temperature	
<b>Ambient operating humidity</b>	10 ~ 90%	
<b>Dimensions (W x H x D)</b>	448 x 433 x 447 mm	492 x 474 x 482 mm
<b>Weight</b>	25 kg	29 kg
<b>Accessory</b>	AC power cord x1	

- Diagrams are shown for explanatory purposes only, and have been exaggerated, abbreviated or created as required, and so may differ from the actual product.
- Features and specifications are subject to change without prior notice or obligations.

## ■ Dimensions

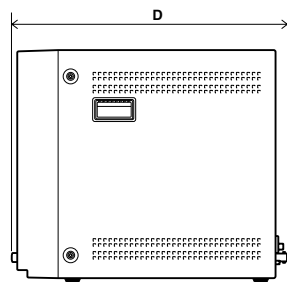
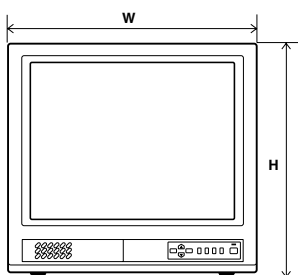

### Y/C (Mini DIN 4 pin) terminal specification

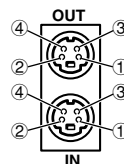

Pin No.	Signal
①	GND (Y)
②	GND (C)
③	Y
④	C

**SANYO INDUSTRIAL VIDEO  
VIDEO MONITOR LIMITED WARRANTY**

**OBLIGATIONS**

In order to obtain warranty service, the product must be delivered to and picked up from an Authorized Sanyo Service Center at the user's expense, unless specifically stated otherwise in this warranty. The names and addresses of Authorized Sanyo Service Centers may be obtained by calling the toll-free number listed below.

For product operation, authorized service center referral, service assistance or problem resolution, call  
**CUSTOMER INFORMATION 1-800-421-5013**  
**Weekdays 8:30 AM – 5:00 PM Pacific Time**

For accessories and/or parts, call  
**PARTS ORDER INFORMATION 1-800-726-9662**  
**Weekdays 8:30 AM – 5:00 PM Pacific Time**

THIS WARRANTY IS VALID ONLY ON SANYO PRODUCTS PURCHASED OR RENTED IN THE UNITED STATES OF AMERICA, EXCLUDING ALL U.S. TERRITORIES AND PROTECTORATES. THIS WARRANTY APPLIES ONLY TO THE ORIGINAL RETAIL PURCHASER OR END-USER. THE ORIGINAL DATED BILL OF SALE, SALES SLIP OR RENTAL AGREEMENT MUST BE SUBMITTED TO THE AUTHORIZED SANYO SERVICE CENTER AT THE TIME WARRANTY SERVICE IS REQUESTED.

Subject to the OBLIGATIONS above and EXCLUSIONS below, SANYO Fisher Company warrants this SANYO product against defects in materials and workmanship for the periods specified below. SFC will repair or replace (at its option) the product and any of its parts which fail to conform to this warranty. The warranty period commences on the date the product was first purchased or rented at retail.

LABOR	PARTS	PICTURE TUBE
1 YEAR	1 YEAR	1 YEAR

**EXCLUSIONS**

This warranty does not cover (A) the adjustment of customer-operated controls as explained in the appropriate model's instruction manual, or (B) the repair of any product whose serial number has been altered, defaced or removed.

This warranty shall not apply to the cabinet or cosmetic parts, batteries or routine maintenance.

This warranty does not apply to uncrating, setup, installation, removal of the product for repair or reinstallation of the product after repair.

This warranty does not apply to repairs or replacements necessitated by any cause beyond the control of SFC including, but not limited to, any malfunction, defect or failure caused by or resulting from unauthorized service or parts, improper maintenance, operation contrary to furnished instructions, shipping or transit accidents, modification or repair by the user, abuse, misuse, neglect, accident, incorrect power line voltage, fire, flood or other Acts of God, or normal wear and tear.

The foregoing is in lieu of all other expressed warranties and SFC does not assume or authorize any party to assume for it any other obligation or liability.

SFC DISCLAIMS ALL OTHER WARRANTIES EXPRESS OR IMPLIED, WITH REGARD TO THIS PRODUCT (INCLUDING THE WARRANTIES OF MERCHANTABILITY AND FITNESS). IN NO EVENT SHALL SFC BE LIABLE FOR ANY SPECIAL, INCIDENTAL OR CONSEQUENTIAL DAMAGES ARISING FROM THE OWNERSHIP OR USE OF THIS PRODUCT OR FOR ANY DELAY IN THE PERFORMANCE OF ITS OBLIGATIONS UNDER THIS WARRANTY DUE TO CAUSES BEYOND ITS CONTROL. SFC'S LIABILITY FOR ANY AND ALL LOSSES AND DAMAGES RESULTING FROM ANY CAUSE WHATSOEVER, ARISING OUT OF OR IN CONNECTION WITH THE SALE, USE OR OWNERSHIP OF THIS PRODUCT INCLUDING WARRANTOR'S NEGLIGENCE, ALLEGED DAMAGED OR DEFECTIVE GOODS, WHETHER SUCH DEFECTS ARE DISCOVERABLE OR LATENT, SHALL IN NO EVENT EXCEED THE PURCHASE PRICE OF THE PRODUCT.

**ATTENTION**

For your protection in the event of theft or loss of this product, please fill in the information below for you own personal records.

**Model No.** \_\_\_\_\_

**Serial No.** \_\_\_\_\_  
 (Located on back or bottom side of unit.)

**Date of Purchase** \_\_\_\_\_

**Purchase Price** \_\_\_\_\_

**Where Purchased** \_\_\_\_\_



**SANYO Electric Co., Ltd.**

Printed on recycled paper

Printed in Taiwan

1AC6P1P2709--  
 L8MV5/US--2, L8MZ5/US--2 (0503KP-TVS)  
 312-0219-101

## Free Manuals Download Website

<http://myh66.com>

<http://usermanuals.us>

<http://www.somanuals.com>

<http://www.4manuals.cc>

<http://www.manual-lib.com>

<http://www.404manual.com>

<http://www.luxmanual.com>

<http://aubethermostatmanual.com>

Golf course search by state

<http://golfingnear.com>

Email search by domain

<http://emailbydomain.com>

Auto manuals search

<http://auto.somanuals.com>

TV manuals search

<http://tv.somanuals.com>