

# SANYO

INSTRUCTION MANUAL

## CLT-5810

5.8-GHz  
Cordless Telephone  
with Call Manager Features

**CM**  
CALL MANAGER

**5.8**GHz

**IMPORTANT**

Charge the handset battery pack for a full 15-20 hours before using your cordless handset for the first time.

[www.sanyocanada.com](http://www.sanyocanada.com)

## Introduction

Congratulations on your purchase of the CLT-5810 cordless telephone from SANYO.

This phone is designed for reliability, long life, and outstanding performance utilizing the latest in 5.8 GHz technology.

### Note:

Some illustrations in this manual may differ from the actual unit for explanation purposes.

## Features

- Call Manager Features\*: Caller ID and Caller ID on Call Waiting.  
\*Each feature works with your network service. A subscription is required.
- 30-Number Caller ID List
- 3-Line, 16-Character Backlit Handset Display
- Speed Dial
- 20-Name/Number Directory
- Last Number Redial
- English, French or Spanish Display Option
- Voice Mail Waiting Indicator
- 14-Day Standby Battery Life/7-Hour Talk Time
- 10-Channel Autoscan
- Call Time Display
- Pulse/Tone Dialing
- Page/Handset Locator
- Handset Earpiece and Ringer Volume Controls
- Wall-Mountable
- Hearing Aid Compatible

Your Sanyo 5.8-GHz COMPANDER PLUS cordless telephone is a fine-quality home communications product. It is carefully designed and produced by a world leader of consumer and industrial electronics equipment. With proper maintenance and care, it will provide you with years of enjoyment and convenience.

### 5.8-GHz Technology

The clearest channel is automatically selected for each transmission. The phone selects one of over 262,000 digital security codes for the handset and base.

These features enhance your phone's security and also prevent unauthorized calls as a result of your phone being activated by other equipment.

# CONTENTS

Introduction/Features .....	inside front cover
Controls and functions.....	E2
<b>Getting started</b>	
Checking the package contents.....	E4
Setting up the phone .....	E4
Mounting the base unit on a wall.....	E9
Setting menu options .....	E11
<b>Basics</b>	
Making and receiving calls.....	E14
Adjusting the handset ringer and earpiece volume.....	E15
Redial.....	E16
Tone dialing switch-over.....	E16
Traveling out-of-range .....	E16
Selecting a different channel.....	E17
Page .....	E17
Flash and call waiting .....	E17
Voice mail waiting indicator .....	E18
<b>Directory</b>	
Storing phone numbers and names.....	E19
Steps for entering names and special characters .....	E21
Making calls with memory dialing .....	E23
Chain dialing .....	E24
Editing a stored name and/or phone number .....	E25
Erasing a stored name and phone number .....	E27
<b>Speed dial</b>	
Speed dial .....	E28
Storing and editing the speed dial .....	E28
Making calls with the speed dial.....	E29
Deleting the speed dial .....	E29
<b>Caller ID features</b>	
Caller ID .....	E30
When the telephone rings .....	E30
Viewing the Caller ID message list .....	E31
Deleting information from the Caller ID list.....	E32
Using the Caller ID list .....	E34
<b>Additional Information</b>	
Changing the digital security code .....	E36
Installing the beltclip.....	E36
Note on power sources.....	E37
Troubleshooting .....	E38
Technical Information .....	E40
Warranty.....	E41
Sanyo-On-Site (SOS) Information .....	E42

Getting Started

Basics

Directory

Speed Dial

Caller ID  
Features

Additional  
Information

E1

## Controls and functions

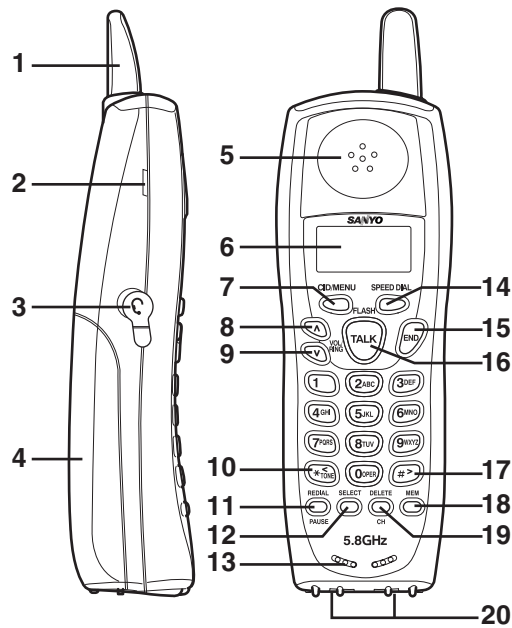

- |                                   |   |
|-----------------------------------|---|
| 1. Handset antenna                | 11. REDIAL/PAUSE key                      |
| 2. Beltclip hole                  | 12. SELECT key                            |
| 3. Headset jack                   | 13. Handset microphone and ringer speaker |
| 4. Handset battery compartment    | 14. SPEED DIAL key                        |
| 5. Handset earpiece               | 15. END key                               |
| 6. LCD display                    | 16. TALK/FLASH key                        |
| 7. CID (caller ID)/MENU key       | 17. #/> (right cursor) key                |
| 8. ^ (up) VOL (volume)/RING key   | 18. MEM (memory) key                      |
| 9. v (down) VOL (volume)/RING key | 19. DELETE/CH key                         |
| 10. */TONE/ < (left cursor) key   | 20. Handset charging contacts             |

E2

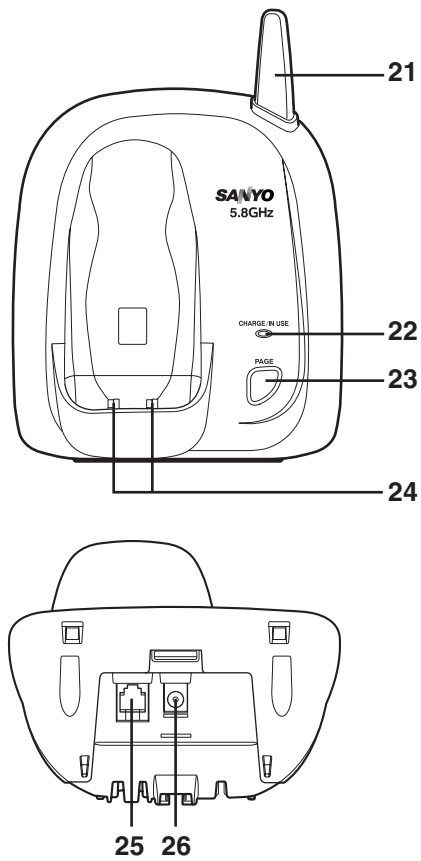

- |                       |                            |
|-----------------------|----------------------------|
| 21. Base antenna      | 24. Base charging contacts |
| 22. CHARGE/IN USE LED | 25. Telephone line jack    |
| 23. PAGE key          | 26. DC IN 9V jack          |

## GETTING STARTED

### Checking the package contents

Make sure you have received the following items in the package.

- Base unit
- AC adapter
- Telephone cord
- Handset
- Rechargeable battery
- This instruction manual
- Belt Clip

### Setting up the phone

**Do the following steps:**

- A. Choose the best location
- B. Install the rechargeable battery pack into the handset
- C. Connect the base unit and charge the handset

#### A. Choose the best location

Here are some important guidelines you should consider:

- The location should be close to both a phone jack and a continuous power outlet that is not switchable.
- Keep the base and handset away from sources of electrical noise such as motors, microwave ovens, and fluorescent lighting.
- The base should be placed in an open area for optimum range and reception.
- The base can be placed on a desk, tabletop, or mounted on a standard wall plate.

#### Note:

If your home has specially wired alarm equipment connected to the telephone line, be sure that installing the system does not disable your alarm equipment.

If you have questions about what will disable your alarm equipment, contact your telephone company or a qualified installer.

## GETTING STARTED

### B. Install the rechargeable battery pack into the handset

The handset is powered by a rechargeable battery pack.

The battery recharges automatically when the handset is placed in the base unit.

#### IMPORTANT

Use only the Sanyo rechargeable battery pack supplied with your cordless telephone.

**Charge the handset battery pack for at least 15-20 hours before using your new cordless telephone for the first time!** To maximize the charge capacity of your battery pack, **DO NOT** plug the telephone cord into the base unit and wall jack until the battery is fully charged.

- 1 Press down on the handset battery case cover (use the finger indentation for a better grip) and slide the cover downward to remove.
- 2 Plug the battery pack connector (red & black wires) into the small, black jack inside the battery compartment. (The connector notches fit into the grooves of the jack only one-way.) Match the wire colors to the polarity label in the battery compartment, connect the battery and listen for a click to ensure connection.
- 3 Make sure you have a good connection by pulling slightly on the battery wires. If the connection is secure, the battery jack will remain in place.
- 4 Place the battery case cover back on the handset by sliding it upwards until it clicks into place.

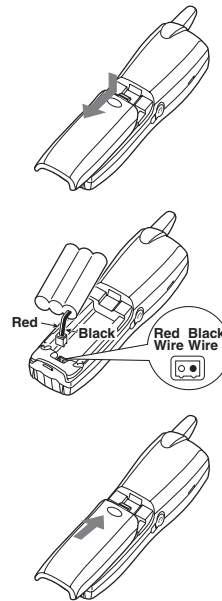

## GETTING STARTED

### Low battery alert

When the battery pack is very low and needs to be charged, the phone is programmed to eliminate functions in order to save power.

If the phone is not in use, "Low Battery" appears on the LCD and none of the keys will operate.

If the phone is in use, "Low Battery" flashes and the handset beeps. Complete your conversation as quickly as possible and return the handset to the base unit for charging.



Low Battery

#### Notes:

- The last number dialed in the redial memory and the numbers stored in the memory locations are retained for up to 3 minutes while you replace the battery pack.
- Even when the battery pack is not being used, it will gradually discharge over a long period of time. For optimum performance, be sure to return the handset to the base unit after a telephone call.

### Cleaning the battery charging contacts

To maintain a good charge, it is important to clean the charging contacts on both the handset and the base unit once a month. Using rubbing alcohol, dampen a cloth to clean the charging contacts. Then make sure to go back over the charging contacts with a dry cloth before returning the handset to the base to charge.



**Caution:** Prevent alcohol from prolonged contact with cabinet to avoid possible damage to the finish.

### Terminology

- **Talk Mode** -  
The handset is off the base and the **TALK/FLASH** key has been pressed, enabling a dial tone.
- **Standby Mode** -  
The handset is not in use, off the base, and the **TALK/FLASH** key has not been pressed. A dial tone is not present.

E6



## GETTING STARTED

### C. Connect the base unit and charge the handset

- 1 Connect the AC adapter to the **DC IN 9V** jack and to a standard 120V AC wall outlet.
- 2 Set the base on a desk or tabletop, and place the handset in the base unit.
- 3 Make sure that the **CHARGE/IN USE LED** illuminates.

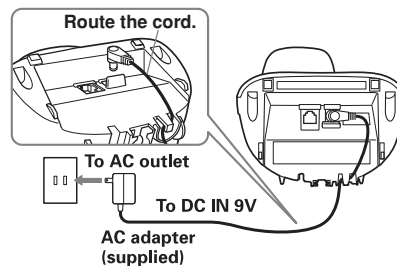

If the LED does not illuminate, check to see that the AC adapter is plugged in and the handset makes good contact with the base charging contacts.

#### Notes:

- Connect the AC adapter to a continuous power supply.
- Place the base unit close to the AC outlet so that you can unplug the AC adapter easily.

#### IMPORTANT

- Use only the supplied Sanyo AC adapter. Do not use any other AC adapter.
- Do not place the power cord so that it creates a trip hazard or where it could become damaged and create a fire or electrical hazard.

## GETTING STARTED

- After installing the battery pack in the handset, charge your handset at least **15-20 hours before plugging into the phone line.**

- 4** Place the handset in the base unit for 15-20 hours without interruption. The base unit's LED light (labeled **CHARGE/IN USE**) illuminates once the handset is placed in the base. The LED light will illuminate whether the battery pack is connected or not.

If the base **CHARGE/IN USE** LED light does not illuminate:

- Check to see if the AC adapter is plugged into the base unit and the electrical wall outlet properly. (Use only the supplied AC adapter. Do not use any other AC adapter.)
- Check to see if the handset is sitting correctly in the base and making good contact with the base unit's charging contacts.

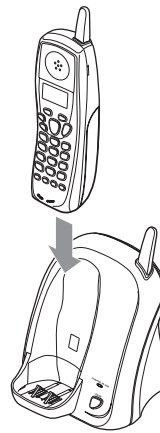

- 5** Once the handset battery pack is fully charged, connect the telephone line cord to the **TEL LINE** jack and to a telephone outlet.

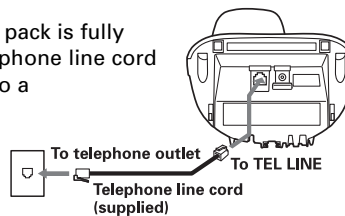

**Tip:**

If your telephone outlet isn't modular, contact your telephone company for assistance.



Modular

## GETTING STARTED

### Mounting the base unit on a wall

#### Standard wall plate mounting

This phone can be mounted on any standard wall plate.

- 1** Plug the AC adapter into the **DC IN 9V** jack.
- 2** Wrap the AC adapter cord inside the molded wiring channel as shown.
- 3** Plug the AC adapter into a standard 120V AC wall outlet.
- 4** Plug the telephone line cord into the **TEL LINE** jack. Wrap the cord inside the molded wiring channel as shown.
- 5** Plug the telephone line cord into the telephone outlet.
- 6** Align the mounting slots on the base with the mounting posts on the wall. Then push in and down until the phone is firmly seated.

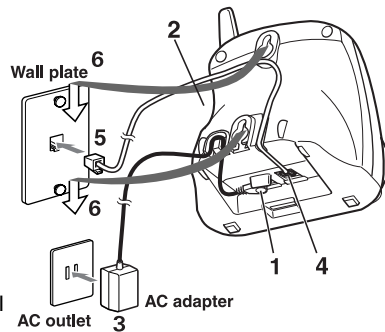

#### IMPORTANT

DO NOT use an AC outlet controlled by a wall switch.

## GETTING STARTED

### Direct wall mounting

If you don't have a standard wall plate, you can mount your phone directly to the wall. Before doing this, consider the following:

- Avoid electrical cables, pipes, or other items behind the mounting location that could cause a hazard when inserting screws into the wall.
- Try to mount your phone within 5 feet of a working phone jack to avoid excessive cable lengths.
- Make sure the wall material is capable of supporting the weight of the base and handset.
- Use #10 screws (minimum length of 1-3/8 inches) with anchoring devices suitable for the wall material where the base unit will be placed.

- 1** Insert two mounting screws into the wall, (with their appropriate anchoring device), 3-15/16 inches apart.

Allow about 1/8 of an inch between the wall and screw heads for mounting the phone.

- 2** Refer to steps 1 through 6 on page E9 to mount the telephone.

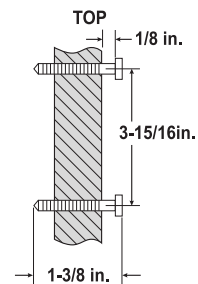

## GETTING STARTED

### Setting menu options

There are five setup options available. They are Automatic Talk, CIDCW (Caller ID on Call Waiting), Area Code, Dial and Language.

Automatic Talk allows you to answer the phone without pressing the **TALK/FLASH** key.

If the phone rings when Automatic Talk is On, simply remove the handset from the base and the phone automatically answers the call. If the phone rings when Automatic Talk is Off, you must press the **TALK/FLASH** key to answer the call.

Automatic Standby allows you to hang up by simply returning the handset to the base.

#### Changing your Automatic Talk (Auto Talk) and CIDCW:

- 1 When the phone is in standby mode, press and hold the **CID/MENU** key.

```

Auto Talk :Off
CIDCW    :On
Area Code :
  
```

The following screen appears.

- 2 Use the **^ VOL/RING** or **v VOL/RING** key to move the pointer to the selection that you would like to change.

Press the **SELECT** key to toggle between "On" and "Off".

- 3 Press the **END** key and return the handset to the base unit to complete the setting. The handset returns to standby mode.

## GETTING STARTED

### Entering your area code

If you enter a 3-digit area code number in the Area Code option, your local area code does not appear in Caller ID messages. Do not program this option if your calling area requires 10-digit dialing. When reviewing Caller ID messages, you will see only the local seven digit number. For calls received from outside your local area code, you will see a full 10-digit number.

- 1 When the phone is in standby mode, press and hold the **CID/MENU** key. The following screen appears.
 

Auto Talk	:Off
CIDCW	:On
Area Code	:
- 2 Press the **✓ VOL/RING** key twice to select "Area Code".
 

Auto Talk	:Off
CIDCW	:On
Area Code	:
- 3 Press the **SELECT** key.
- 4 Use the number (**0 - 9**) or **DELETE/CH** key to enter the 3-digit area code.
 

Auto Talk	:Off
CIDCW	:On
Area Code	: ■
- 5 Press the **SELECT** key. A confirmation tone sounds and the displayed area code is entered.
- 6 Press the **END** key or return the handset to the base unit to complete the setting. The handset returns to standby mode.

#### Note:

When the area code has already been stored in memory, the stored area code will be displayed. To change it, use the **DELETE/CH** key and number keys to enter the new area code.

Auto Talk	:Off
CIDCW	:On
Area Code	:817

Then press the **SELECT** key. A confirmation tone sounds. To complete the setting, press the **END** key or return the handset to the base unit.

E12

## GETTING STARTED

### Choosing the dialing mode

Most phone systems use tone dialing which sends DTMF tones through the phone lines. However, some phone systems (such as those in rural areas) still use pulse dialing. The default setting is tone dialing. Depending on your dialing system, set the mode as follows:

#### Notes:

- Make sure your battery pack is fully charged before choosing the dialing mode.
- If you are not sure of your dialing system, set for tone dialing. Make a trial call. If the call connects, leave the setting as is. Otherwise set for pulse dialing.
- If your phone system requires pulse dialing and you need to send the DTMF tones for certain situations during a call, you may "switch-over" to tone dialing. (Refer to "Tone dialing switch-over" on page E16.)

- 1 When the phone is in standby mode, press and hold the **CID/MENU** key. The following screen appears.

```
▶Auto Talk :Off
CIDCW      :On
Area Code  :
```

- 2 Press the **∨ VOL/RING** key three times to select "Dial".

```
CIDCW      :On
Area Code  :
▶Dial      :Tone
```

- 3 Press the **SELECT** key to toggle between "Tone" and "Pulse".

- 4 Press the **END** key or return the handset to the base unit to complete the setting. The handset returns to standby mode.

### Setting the language

- 1 When the phone is in standby mode, press and hold the **CID/MENU** key. The following screen appears.

```
▶Auto Talk :Off
CIDCW      :On
Area Code  :
```

- 2 Press the **∨ VOL/RING** key four times to select "Language".

```
Area Code  :
Dial       :Tone
▶Language   :Eng
```

- 3 Press the **SELECT** key to toggle between "Eng", "Fr." and "Esp".

- 4 Press the **END** key or return the handset to the base unit to complete the setting. The handset returns to standby mode.

E13

## BASICS

### Making and receiving calls

	Handset On Base	Handset Off Base
To receive a call	Pick up the handset (Automatic Talk: On) or pick up the handset and press the <b>TALK/FLASH</b> key (Automatic Talk: Off).	Press the <b>TALK/FLASH</b> key (Automatic Talk: Off), or press the <b>TALK/FLASH</b> , <b>* /TONE/ &lt; , # / &gt;</b> , or any number key (Automatic Talk: On).
To make a call	<ol style="list-style-type: none"> <li>1) Pick up the handset.</li> <li>2) Press the <b>TALK/FLASH</b> key.</li> <li>3) Listen for the dial tone.</li> <li>4) Dial the number.</li> </ol> <p>OR</p> <ol style="list-style-type: none"> <li>1) Pick up the handset.</li> <li>2) Dial the number, then press the <b>TALK/FLASH</b> key.</li> </ol>	<ol style="list-style-type: none"> <li>1) Press the <b>TALK/FLASH</b> key.</li> <li>2) Listen for the dial tone.</li> <li>3) Dial the number.</li> </ol> <p>OR</p> <p>Dial the number, then press the <b>TALK/FLASH</b> key.</p>
To hang up	Press the <b>END</b> key or return the handset to the base (Automatic Standby).	
To redial	<ol style="list-style-type: none"> <li>1) Pick up the handset.</li> <li>2) Press the <b>TALK/FLASH</b> key.</li> <li>3) Listen for the dial tone.</li> <li>4) Press the <b>REDIAL/PAUSE</b> key.</li> </ol> <p>OR</p> <ol style="list-style-type: none"> <li>1) Pick up the handset.</li> <li>2) Press the <b>REDIAL/PAUSE</b> key, then press the <b>TALK/FLASH</b> key.</li> </ol>	<ol style="list-style-type: none"> <li>1) Press the <b>TALK/FLASH</b> key.</li> <li>2) Listen for the dial tone.</li> <li>3) Press the <b>REDIAL/PAUSE</b> key.</li> </ol> <p>OR</p> <p>Press the <b>REDIAL/PAUSE</b> key, then press the <b>TALK/FLASH</b> key.</p>

#### Note:

Refer to page E11 "Setting menu options" to turn on the Automatic Talk feature if desired.



## BASICS

### Adjusting the handset ringer and earpiece volume

#### Handset ringer tone and volume

Press the volume up key or volume down key (labeled as, the **^ VOL/RING** or **∨ VOL/RING** key) in standby mode to select one of five ringer tones and volume combinations.

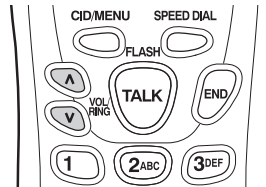

#### Earpiece volume

Pressing the volume up key or volume down key (labeled as, the **^ VOL/RING** or **∨ VOL/RING** key) during a call will change the earpiece volume of the handset. This setting will remain in effect after the telephone call has ended.

#### Note:

When you press volume up key (the **^ VOL/RING** key) to the maximum mode or volume down key (the **∨ VOL/RING** key) to the lowest mode, an error tone sounds.

#### Temporarily mute ringer

If the handset is off the base, simply press the **END** key to temporarily mute the incoming ring. The ringer will sound with the next incoming call.

## BASICS

### Redial

The **REDIAL/PAUSE** key redials the last number dialed. The redialed number can be up to 32 digits long.

### Tone dialing switch-over

Some telephone companies use equipment that requires pulse dialing (sometimes referred to as rotary dialing).

If you need to enter tone dialing digits, you can switch-over to tone dialing during the call. This feature is useful when you need tone dialing to use automated systems, for example, entering your bank account number after you have called your bank.

Initially make your call with the pulse dialing mode. Once your call connects, press the **\* /TONE/ <** key. Enter the desired number. These digits will be sent as tone dialing. Once the call ends, the tone mode is canceled and pulse dialing mode resumes.

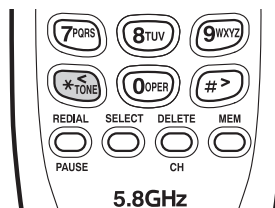

#### Notes:

- This tone feature only applies when the dial mode is set to pulse.
- This special number can be stored in a memory location. This is referred to as Chain dialing (See page E24).

### Traveling out-of-range

During a call, as you begin to move your handset too far from your base unit, noise increases. If you pass the range limits of the base unit, your call may be disconnected.

## BASICS

### Selecting a different channel

If you encounter interference while using your phone, you can manually change the phone's channel for clear operation. This function works only when the phone is in use. Press the **DELETE/CH** key. "Scanning" appears on the display, indicating the phone is changing to another channel.

### Page

To locate the handset (while it's off the base), press the **PAGE** key on the base. The handset beeps for 60 seconds.

Paging is canceled when pressing any handset key, the **PAGE** key on the base or when the handset is returned to the base.



#### Note:

Paging is also canceled when the phone receives an incoming call.

### Flash and call waiting

If you have "Call Waiting" service and a call waiting tone sounds while you are on a call, press the **TALK/FLASH** key to accept the waiting call. There is a short pause, then you will hear the new caller. To return to the original caller, press the **TALK/FLASH** key again.

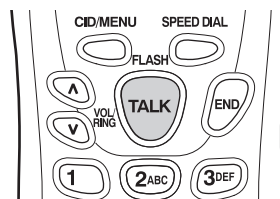

#### Note:

You must subscribe through your local telephone company to receive Call Waiting service.

## BASICS

### Voice mail waiting indicator

If you subscribe to voice mail service, you can use your cordless telephone to access your voice mailbox. The **CHARGE/IN USE LED** light on the base of your phone flashes whenever you have messages waiting in your voice mailbox. Just program the **SPEED DIAL** key with your access number and you can get your messages at the touch of a button. (The voice mail service provider will supply you with the access number. This number may be simply a phone number. Refer to the provider's literature.)

You may need to occasionally reset the indicator if it continues to flash after you have retrieved your messages. To reset the indicator, press and hold the **PAGE** key for 5 seconds.

#### Note:

You must subscribe to voice mail service from your telephone company in order to use this feature. The voice mail company will provide you with the access number.

# DIRECTORY

## Storing phone numbers and names

Memory Dialing allows you to dial a number by pressing just a few keys.

Your cordless phone stores up to 10 names/numbers in the handset.

### Note:

In memory dialing operation, you must press a key within 30 seconds or the phone will return to standby mode. If you return the handset to the base, the phone will return to standby mode also.

- 1** Press the **MEM** key in standby mode.  
"Select Memory" is displayed.

```
Select Memory
01
02 Alison
```

- 2** Press the **^ VOL/RING** or **∨ VOL/RING** key, or enter a number (0 - 9) to select the memory location where you would like to store the number.

- 3** Press the **MEM** or **SELECT** key.

```
01: (Empty)
Press Select
to edit
```

- 4** Press the **MEM** or **SELECT** key again.  
"Store Name" appears and a cursor flashes indicating that the display is ready for the name to be entered.

```
Store Name
```

If the Edit screen appears, the selected memory location is already stored. Then you must either edit the entry in this location, delete the entry in this location, or select "Go Back" to choose another location.

```
Edit Memory01
Delete Memory01
Go Back
```

- 5** To enter a name (up to 13 characters), use the number keys.

- See the "Steps for entering names and special characters." (See page E21).
- Use the **#/>** and **\* /TONE/ <** keys to move the cursor to the desired location.
- Use the **DELETE/CH** key to delete characters as needed.
- Press and hold the **DELETE/CH** key to delete all the characters.
- If a name is not required, go to step 6.

## DIRECTORY

- 6** Press the **MEM** or **SELECT** key. "Store Number" is displayed. The cursor flashes indicating that the display is ready for the number to be entered.

Store Number

**Note:**

You have 30 seconds after pressing the **MEM** or **SELECT** key to enter the number you wish to store. Otherwise, an error tone will sound and the phone will return to standby mode.

- 7** Use the number keys to enter the phone number. The phone number cannot exceed 20 digits.

Store Number  
9057609944

Use the **REDIAL/PAUSE** key to enter a pause in the dialing sequence.

The display shows a "P". Each pause counts as one digit and represents a two second delay of time between the digits.

Use the **DELETE/CH** key to delete digits as needed.

**Notes:**

- The pause feature is useful for long distance calling, credit card dialing, or sequences that require a pause between digits.
- The pause key counts as one digit. Pressing the **REDIAL/PAUSE** key more than once increases the length of a pause between numbers.

- 8** Press the **MEM** or **SELECT** key. You will hear a confirmation tone, and the following screen appears. Memory storage is complete.

For example, if you store a name and number into memory location number 01, the display shows "Memory01 Stored".

Memory01 Stored

After about 2 seconds, the following screen is displayed.

01 SANVO  
02 ALISON  
03 MOM AND DAD

Repeat steps 2 - 8 to store more numbers.

- 9** Press the **END** key to return to standby mode.

E20

# DIRECTORY

## Steps for entering names and special characters

Refer to the letters on the number keys to select the desired characters.

With each press of a numeric key, the displayed character appears in the following order: Upper case letters first, lower case letters next and finally the number corresponding to the key.

### If you make a mistake while entering a name

Use the **\*/TONE/<** or **\*/>** key to move the cursor to the incorrect character.

Press the **DELETE/CH** key to erase it, then enter the correct character. To delete all characters, press and hold the **DELETE/CH** key.

Keys	Number of time key is pressed								
	1	2	3	4	5	6	7	8	9
1	1								
2ABC	A	B	C	a	b	c	2		
3DEF	D	E	F	d	e	f	3		
4GHI	G	H	I	g	h	i	4		
5JKL	J	K	L	j	k	l	5		
6MNO	M	N	O	m	n	o	6		
7PQRS	P	Q	R	p	q	r	s	7	
8TUV	T	U	V	t	u	v	8		
9WXYZ	W	X	Y	w	x	y	z	9	
0OPER	*	#	-	&	(	)	(blank)	0	

### Note:

If the next character uses the same number key, you must press the **\*/>** key to move the cursor over. Otherwise the next time you press the number key, it changes the character that was previously set.

## DIRECTORY

For example, to enter **SANYO**.

- 1** Pick up the handset. Press the **MEM** key.
- 2** Enter a number or press the **^ VOL/RING** or **∨ VOL/RING** key to select a memory location.
- 3** Press the **MEM** or **SELECT** key.
- 4** Press the **MEM** or **SELECT** key again. (When there is information already stored in the selected memory location, "Edit Memory:XX" is displayed. See page E25 for information on "Editing a stored name and/or phone number".)
- 5** Press **7** four times.
- 6** Press **2** once.
- 7** Press **6** twice.
- 8** Press **9** three times.
- 9** Press **6** three times.
- 10** When finished, press the **MEM** or **SELECT** key.

To continue to store the telephone number, proceed to step 7 on page E20.



## DIRECTORY

### Making calls with memory dialing

#### Memory dialing from Standby Mode

- 1 Press the **MEM** key. The handset displays your programmed memory locations.
 

Select Memory  
 01 SANYO  
 02 ALISON
- 2 Press the **^ VOL/RING** or **∨ VOL/RING** key, or enter the number (0 - 9) to select the memory location you would like to dial.
- 3 Press the **TALK/FLASH** key. "Talk" and the volume setting appear on the display. Then the displayed number is dialed.
 

Talk  
 9057609944

#### Notes:

- If you press the **SELECT** key before the **TALK/FLASH** key, you can confirm the name and the number stored in the selected memory location.
- Whenever you are using a memory menu screen, you must press a key within 30 seconds or the phone will return to standby.
- To exit the memory function without dialing, press the **END** key. The handset returns to standby mode.

#### Memory dialing from Talk Mode

- 1 Press the **TALK/FLASH** key. "Talk" and the volume setting appears.
 

Talk

⇒

Talk  
 Volume High
- 2 Press the **MEM** key.
- 3 Press the **^ VOL/RING** or **∨ VOL/RING** key, or enter a number (0 - 9) to select the memory location of the desired phone number. Press the **SELECT** key, the number is dialed.
 

Select Memory  
 01 SANYO  
 02 ALISON

Talk 0:35  
 9057609944
- 4 To hang up, press the **END** key.

E23

## DIRECTORY

### Chain dialing

The memory locations on the handset are not limited to phone numbers. You can also store a group of numbers (up to 20 digits) that you need to enter once your call connects. This is referred to as Chain Dialing.

An example of this is a bank account number. Once you have called your bank, and are prompted to enter the account number, press the **MEM** key and select the location number where the special number has been stored. Then press the **SELECT** key.

Store your special number with an identifying name.  
(Refer to "Storing phone numbers and names" on page E19.)

# DIRECTORY

## Editing a stored name and/or phone number

- 1** Press the **MEM** key in standby mode, "Select Memory" is displayed.

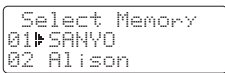

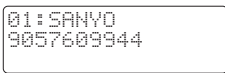
- 2** Press the **^ VOL/RING** or **∨ VOL/RING** key, or enter a number (0 - 9) to select the memory location you would like to edit, and press the **MEM** or **SELECT** key.

- 3** Press the **MEM** or **SELECT** key a second time.

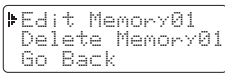
The following screen appears with the memory location number that you have selected in the display.

- 4** Press the **^ VOL/RING** or **∨ VOL/RING** key to select "Edit MemoryXX", then press the **MEM** or **SELECT** key. The following screen appears. The cursor flashes, indicating that the display is ready for the name to be edited. When a name has not been stored, the cursor appears at the beginning of the second line.

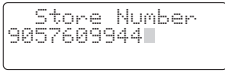
- 5** Use the **\*/TONE/ <, #/>**, **DELETE/CH**, or any number key to edit the name. (See page E21.) To edit only the phone number, skip this step.
- 6** Press the **MEM** or **SELECT** key. The following screen appears.



The cursor flashes indicating that the display is ready for the number to be edited.
- 7** Use the **\*/TONE/ <, #/>**, **REDIAL/PAUSE, DELETE/CH**, or any number key to edit the phone number. The phone number cannot exceed 20 digits. (See page E20.)

If you don't want to change the phone number, skip this step.

## DIRECTORY

- 8** Press the **MEM** or **SELECT** key. If you changed either a name or phone number, a confirmation display shows up. If it is correct, press the **^ VOL/RING** key to move the pointer to "Yes" and press the **SELECT** key. You will hear a confirmation tone, and the following screen appears. The memory storage is complete.

```
Replace Memory?
  Yes
  No
```

```
Memory01 Stored
```

For example, if you store a name and number into memory location number 01, the display shows "Memory01 Stored". After about 2 seconds, Select Memory screen is displayed.

```
01 SANYO
02 Alison
03 MOM AND DAD
```

- 9** Press the **END** key to return to standby mode.

## DIRECTORY

### Erasing a stored name and phone number

- 1** Press the **MEM** key in standby mode. "Select Memory" is displayed.

Select Memory  
 01 SANVO  
 02 Alison
  
- 2** Press the **^ VOL/RING** or **v VOL/RING** key, or enter a number (0 - 9) to select the memory location you would like to erase.
  
- 3** Press the **MEM** or **SELECT** key.

The name and phone number selected appears with the memory location number that you have selected in the display.

02:Alison  
 5452930
  
- 4** Press the **MEM** or **SELECT** key again.
- 5** Press the **v VOL/RING** key to move the pointer down to "Delete MemoryXX".

Edit Memory02  
 Delete Memory02  
 Go Back
  
- 6** Press the **MEM** or **SELECT** key. "Delete MemoryXX?" appears.

Delete Memory02?  
 Yes  
 No
- 7** Press the **^ VOL/RING** key to move the pointer to "Yes".
- 8** Press the **SELECT** or **DELETE/CH** key.

You will hear a confirmation tone, and "MemoryXX Deleted" appears.

Memory02 Deleted
- 9** After about 2 seconds, the display returns to the Select Memory screen. You may delete the information in another memory location (return to step 2) or press the **END** key to return to standby mode.

01 SANVO  
 02  
 03 MOM AND DAD

## SPEED DIAL

### Speed dial

You can store your most frequently dialed number in the Speed Dial location. The Speed Dial allows you to dial a number with one key press. (There is no need to press the **TALK/FLASH** key. The phone will automatically dial the number stored). If you subscribe to voice mail service, store your access number in this location.

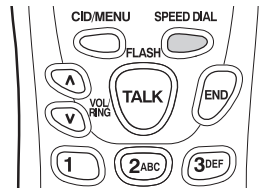

### Storing and editing the speed dial

- 1 When the phone is in standby mode, press and hold the **SPEED DIAL** key. The following display appears.

Store Number

If the Edit screen appears, there is a number already stored. Press the **^ VOL/RING** or **∨ VOL/RING** key to select "Edit Number". Then press the **SELECT** key.

Edit Number  
Delete Number  
Go Back

- 2 Store the number by following step 7 under "Storing phone numbers and names" on page E20.

Store Number  
800

- 3 Press the **SELECT** key.

You will hear a confirmation tone, and "Number Stored" appears. Memory storage is complete.

Number Stored

#### Note:

Number stored in Speed Dial is independent from the numbers stored in Memory Dial.

## SPEED DIAL

### Making calls with the speed dial

When the phone is in standby mode, simply press the **SPEED DIAL** key. The number stored in the Speed Dial memory location is instantly dialed.

#### Note:

If Speed Dial does not have a stored number, the handset will beep rapidly, and the phone will not dial.

### Deleting the speed dial

- 1 When the phone is in standby mode, press and hold the **SPEED DIAL** key. The following display appears.

```

Edit Number
Delete Number
Go Back
  
```

- 2 Press the **^ VOL/RING** or **v VOL/RING** key to select "Delete Number".

- 3 Press the **SELECT** key. The following display appears.

```

Delete Number?
Yes
No
  
```

- 4 Press the **^ VOL/RING** key to move the pointer to "Yes".

- 5 Press the **SELECT** or **DELETE/CH** key.

You hear a confirmation tone, and the following display appears. After about 2 seconds, the handset returns to standby mode.

```

Number Deleted
  
```

E29

## CALLER ID FEATURES

### Caller ID

**You must subscribe to Caller ID service to use this feature.**

When the telephone rings, the Caller ID feature allows you to view the caller's name and phone number on the display before you answer the phone. The handset displays the phone number of the incoming call, the name, and time. Additionally, you can dial the displayed number and store the information for memory dialing. Make sure you have turned on the Caller ID on Call Waiting feature. (See page E11.)

### When the telephone rings

- 1 When the Caller ID message is received, the display shows the caller's phone number along with the date and time. The incoming call information is stored in the Caller ID record. If the Caller ID service includes the caller's name, the caller's name appears on the display (up to 15 letters).

The date and time received	5/11 12:30PM
Caller's name	SANVO
Caller's phone number	905-760-9944

You may receive any one of the following messages:

When invalid data is received	"Incomplete Data"
When a private name is received	"Private Name"
When a private number is received	"Private Number"
When a unknown name is received	"Unknown Name"
When a unknown number is received	"Unknown Number"

- 2 When you pick up the phone, the display changes to "Talk". (Automatic Talk feature is set to on.)

#### Notes:

- Data errors appear as "□".
- If you answer a call before the Caller ID message is received (for example, before the second ring), the Caller ID message will not appear.
- When the call is received via a telephone company that does not offer Caller ID service, the caller's phone number and name do not appear. (This includes international calls.)
- When the call is via a private branch exchange (PBX), the caller's phone number and name may not appear.

E30



## CALLER ID FEATURES

### Viewing the Caller ID message list

The Caller ID list stores information for up to 30 incoming calls - even unanswered calls.

- 1 Press the **CID/MENU** key in standby mode.

The summary screen appears. The screen shows the number of new messages and total messages.

```
Caller ID
New :01
Total:02
```

- 2 Press the **^ VOL/RING** or **v VOL/RING** key to display the oldest or latest Caller ID message.

```
5/17 12:30PM 03
SANVO
905-760-9944
```

- 3 Press the **v VOL/RING** key to see the next message. Or press the **^ VOL/RING** key to see the previous message.

- 4 Press the **END** key to return to standby mode.

#### Notes:

- In Caller ID operation, if no key is pressed for more than 30 seconds, an error tone sounds and the telephone returns to standby mode.
- Each message can be up to 15 characters for the phone number and the name.
- The number of calls from the same Caller ID appears next to the received time. Once you view the new message, the number will be cleared and disappear.

## CALLER ID FEATURES

### Deleting information from the Caller ID list

The cordless phone stores up to 30 messages (Caller ID names/numbers). If the phone receives the 31st message, the oldest one in the list is automatically deleted. Caller ID data can also be deleted manually.

#### Deleting a Caller ID message

- 1 Press the **CID/MENU** key in standby mode. Display the message to be deleted from the Caller ID list by pressing the **^ VOL/RING** or **∨ VOL/RING** key.

```
5/17 12:30PM 03
SANYO
905-760-9944
```

- 2 Press the **DELETE/CH** key.

```
Delete Message?
▶ Yes
  No
```

- 3 Press the **^ VOL/RING** or **∨ VOL/RING** key to select "Yes" or "No".

- 4 Press the **SELECT** or **DELETE/CH** key.

#### When the pointer is at "Yes":

You will hear a confirmation tone and the Caller ID message is deleted. The next Caller ID message is then displayed.

#### When the pointer is at "No":

The display returns to the Caller ID message.

#### Deleting all Caller ID names/numbers

- 1 Press the **CID/MENU** key in standby mode.

```
Caller ID
New :01
Total:02
```

- 2 Press the **DELETE/CH** key.

```
Delete All?
  Yes
▶ No
```

- 3 Press the **^ VOL/RING** or **∨ VOL/RING** key to select "Yes" or "No".

E32

## CALLER ID FEATURES

### 4 Press the **SELECT** or **DELETE/CH** key.

#### When the pointer is at "Yes":

You will hear a confirmation tone and all stored Caller ID messages are deleted.

```
Caller ID
Total:00
```

#### When the pointer is at "No":

The display returns to the summary screen.

```
Caller ID
New :01
Total:02
```

### Notes:

- While using the "Delete All?" or "Delete Message?" screen, if no key is pressed for more than 30 seconds, an error tone sounds and the handset returns to standby mode.
- If you get an incoming call or page, the deleting operation is canceled and you can answer the call or page.

## CALLER ID FEATURES

### Using the Caller ID list

#### Calling a party from the Caller ID list

You can place a call from the Caller ID list. The cordless phone stores up to 30 messages (Caller ID names/numbers).

- 1 Press the **CID/MENU** key. Select the phone number that you want to dial by pressing the **^ VOL/RING** or **∨ VOL/RING** key.
 

5/17 12:30PM 03  
 SANYO  
 905-760-9944
- 2 Press the **TALK/FLASH** key. The displayed phone number dials automatically.
 

Talk  
 9057609944

#### Notes:

- You can place a call from Talk Mode. Press the **TALK/FLASH** key, then press the **CID/MENU** key. Select the phone number that you want to dial by pressing the **^ VOL/RING** or **∨ VOL/RING** key. Press the **SELECT** key. The displayed phone number will be dialed.
- You cannot make a call from the Caller ID list if your cordless phone is connected to a private branch exchange (PBX).

#### Long Distance calls and Area Code Setting/Cancellation

Pressing **1** while the incoming Caller ID information is displayed (in step 1), will set or cancel the prefix "1" in the display to set up for a long distance call. Pressing **3** will set or cancel the stored area code.

#### Note:

When a long distance call has been set, "1" appears in the display.

## CALLER ID FEATURES

### Storing Caller ID messages in memory dialing

Messages (Caller ID names/numbers) shown in the Caller ID list can be stored in memory dialing.

**Note:**

You cannot store a Caller ID message if no phone number appears in the message.

- 1** Press the **CID/MENU** key.

Select the phone number to be stored from the Caller ID list by pressing the **^ VOL/RING** or **v VOL/RING** key.

```
5/17 12:30PM
SANVO
905-760-9944
```

- 2** Press the **MEM** key.

```
Select Memory
01
02 Alison
```

- 3** Press the **^ VOL/RING** or **v VOL/RING** key or enter a number (**0 - 9**) to select the memory location to be stored.

- 4** Press the **SELECT** key.

You hear a confirmation tone, and the number is stored in memory. The display returns to the Caller ID list.

```
5/17 12:30PM
SANVO
905-760-9944
```

**Note:**

If a message has already been stored in the selected memory number location, a confirmation screen is displayed.

```
Replace Memory?
Yes
No
```

Press the **^ VOL/RING** key to select "Yes". Press the **SELECT** key to overwrite. The display returns to the Caller ID list.

## ADDITIONAL INFORMATION

### Changing the digital security code

The digital security code is an identification code used to connect the handset and the base unit. Normally, setting the code is not necessary. The first time you charge your handset, the security code is automatically set.

In rare situation that you suspect another cordless telephone is using the same security code, you can change the code.

- 1** Remove the handset from the base unit. Press and hold the **PAGE** key on the base.
- 2** While holding the **PAGE** key, place the handset in the base unit, and leave it there for more than 3 seconds. A new random security code is set.

#### Note:

If the handset battery pack is completely discharged or the battery pack is removed, the digital security code will be lost. If this happens, a new security code is set automatically the next time the battery pack is charged.

### Installing the beltclip

#### To attach the beltclip

Insert the beltclip into the holes on each side of the handset. Press down until it clicks.

#### To remove the beltclip

Pull both sides of the beltclip to release the tabs from the holes.

## ADDITIONAL INFORMATION

### Note on power sources

#### Battery replacement and handling

When the operating time becomes short even after a battery is recharged, please replace the battery.

With normal usage, your battery should last about one year.

**Warning:** To avoid the risk of personal injury or property damage from fire or electrical shock, only use the Sanyo battery model and Sanyo adapter model specifically designated for this product.

#### RECYCLING NICKEL-CADMIUM BATTERIES

#### NICKEL-CADMIUM BATTERIES MUST BE DISPOSED OF PROPERLY.

Nickel-cadmium cells are used in the battery pack. Please take your used nickel-cadmium battery packs to a store that recycles nickel-cadmium batteries.

#### Power Failure

During the period that the power is off, you will not be able to make or receive calls with the telephone.

#### Caution

- Use only the specified Sanyo battery pack.
- Do not remove the battery from the handset to charge it.
- Never throw the battery into a fire, disassemble it, or heat it.
- Do not remove or damage the battery casing.

## ADDITIONAL INFORMATION

### Troubleshooting

If your phone is not performing to your expectations, please try these simple steps first.

Symptom	Suggestion
The <b>CHARGE/IN USE</b> LED won't illuminate when the handset is placed in the base.	<ul style="list-style-type: none"> <li>• Make sure the AC adapter is plugged into the base and wall outlet.</li> <li>• Make sure the handset is properly seated in the base.</li> <li>• Make sure the charging contacts on the handset and base are clean.</li> </ul>
The audio sounds weak and/or scratchy.	<ul style="list-style-type: none"> <li>• Move the handset and/or base to a different location away from metal objects or appliances and try again.</li> <li>• Press the <b>DELETE/CH</b> key to help eliminate background noise.</li> <li>• Make sure that the handset is not too far from the base.</li> </ul>
Can't make or receive calls.	<ul style="list-style-type: none"> <li>• Check both ends of the telephone line cord.</li> <li>• Make sure the AC adapter is plugged into the base and wall outlet.</li> <li>• Disconnect the AC adapter for a few minutes, then reconnect it.</li> <li>• Change the digital security code (see page E36).</li> <li>• Make sure that the handset is not too far from the base.</li> <li>• Charge the handset.</li> </ul>



## ADDITIONAL INFORMATION

Symptom	Suggestion
The handset doesn't ring or receive a page.	<ul style="list-style-type: none"> <li>• The battery pack may be weak. Charge the battery for 15-20 hours.</li> <li>• The handset may be too far away from the base unit.</li> <li>• Place the base unit away from appliances or metal objects.</li> <li>• Change the digital security code (see page E36).</li> <li>• Check the battery pack to ensure that there is a secure connection.</li> <li>• Make sure ringer volume isn't "OFF".</li> <li>• Charge the handset.</li> </ul>
Severe noise interference.	<ul style="list-style-type: none"> <li>• Keep the handset away from microwave ovens, computers, remote control toys, wireless microphones, alarm systems, intercoms, room monitors, fluorescent lights, and electrical appliances.</li> <li>• Move the base to another location or turn off the source of interference.</li> </ul>
The Caller ID does not display.	<ul style="list-style-type: none"> <li>• The handset was picked up before the second ring.</li> <li>• The call was placed through a switchboard.</li> <li>• Call your local telephone company to verify your Caller ID service is current.</li> </ul>
Voice Message Indication does not work.	<ul style="list-style-type: none"> <li>• Contact your local telephone company to make sure that your telephone receives FSK message signaling.</li> </ul>

## ADDITIONAL INFORMATION

### Technical Information

#### IMPORTANT SAFETY INSTRUCTIONS

When using your telephone equipment, basic safety precautions should always be followed to reduce the risk of fire, electric shock and injury to persons, including the following:

- 1 Do not use this product near water, for example, near a bath tub, wash bowl, kitchen sink or laundry tub, in a wet basement or near a swimming pool.
- 2 Avoid using a telephone (other than a cordless type) during an electrical storm. There may be a remote risk of electric shock from lightning.
- 3 Do not use the telephone to report a gas leak in the vicinity of the leak.
- 4 Use only the power cord and batteries indicated in this manual. Do not dispose of batteries in a fire. They may explode. Check with local codes for possible special disposal instructions.

#### SAVE THESE INSTRUCTIONS

**Caution: Risk of explosion if battery is replaced by an incorrect type. Dispose of used batteries according to the instructions.**

#### I.C. Notice

##### TERMINAL EQUIPMENT

###### NOTICE:

This equipment meets the applicable Industry Canada Terminal Equipment Technical Specifications. This is confirmed by the registration number. The abbreviation, IC, before the registration number signifies that registration was performed based on a Declaration of Conformity indicating that Industry Canada technical specifications were met. It does not imply that Industry Canada approved the equipment.

###### NOTICE:

The Ringer Equivalence Number (REN) for this terminal equipment is marked on the equipment itself. The REN assigned to each terminal equipment provides an indication of the maximum number of terminals allowed to be connected to a telephone interface. The termination on an interface may consist of any combination of devices subject only to the requirement that the sum of the Ringer Equivalence Numbers of all the devices does not exceed five.

##### RADIO EQUIPMENT

The term "IC:" before the radio certification number only signifies that Industry Canada technical specifications were met.

Operation is subject to the following two conditions: (1) this device may not cause interference, and (2) this device must accept any interference, including interference that may cause undesired operation of the device. "Privacy of communications may not be ensured when using this telephone".

E40

## THE SANYO COMFORT WARRANTY

### WARRANTY APPLICATION

Sanyo Communications products purchased new, unused in Canada through a Sanyo Authorized Dealer are warranted against manufacturing defects in materials and workmanship for **ONE YEAR** covering parts and labour, from the date of purchase by the original retail purchaser. This warranty only applies in favour of the original retail purchaser of the warranted product.

### SANYO CANADA INC.'S RESPONSIBILITY

During the warranty period, SANYO Canada Inc. will repair, or at our option, replace a Communications product which shows evidence of a manufacturing defect in materials or workmanship. Replacement PARTS are warranted for the remaining portion of the warranty period.

### WHAT IS NOT COVERED

- (a) Communications products purchased outside Canada.
- (b) Communications products purchased in a used condition.
- (c) Communications products purchased from non Sanyo-authorized dealer.
- (d) Communications products not intended for Canadian usage or products without appropriate Canadian regulatory approvals.
- (e) Problems due to product set-up and installation.
- (f) Adjustments that are outlined in the Operating Manual.
- (g) Accessory items including antenna, and batteries,
- (h) Damage in or due to transportation.
- (i) Damage due to improper maintenance, accident, abuse, misuse or negligence.
- (j) Damage caused by lightning and power surges.

### ORIGINAL RETAIL PURCHASER'S RESPONSIBILITY

You, the original retail purchaser, must present your original, dated bill-of-sale together with this warranty to SANYO Canada Inc. or to an authorized Sanyo Service Depot when you make a claim under this warranty.

You, the original retail purchaser, are responsible for any costs of TRANSPORTING the product to and from SANYO Canada Inc. or an authorized Sanyo Service Depot. You also are responsible for the cost of any MAINTENANCE necessary in respect of the product.

### WARRANTY BECOMES VOID

This warranty becomes void if the product's serial numbers are altered or removed or if any repair to the product is made other than by SANYO Canada Inc. or by an authorized Sanyo Service Depot.

### LIMITATIONS

- (a) SANYO Canada Inc. reserves the right to change or improve the design of the model of the product warranted hereunder without incurring any obligation to make any modifications to or to install any improvement in or on the product.
- (b) In no event shall SANYO Canada Inc. or any of its Authorized Dealers be liable for special or consequential damage arising from the use of this product.

### STATUTORY WARRANTIES

The above provisions do not preclude the operation of any applicable provincial statute which in certain circumstances may not allow some of the limitations and exclusions described in this Warranty. Where any terms of this Warranty are prohibited by such a statute, they shall be deemed null and void but the remainder of this warranty shall remain in effect.

### HOW TO OBTAIN WARRANTY SERVICE

Please contact the Sanyo Authorized Dealer from whom the product was purchased, or contact us directly at:

**SANYO Canada Inc.**  
**1-300 Applewood Cres.**  
**Concord, Ont. L4K 5C7**  
**(905) 760-9944**  
**1-800-263-2244**

## SOS HELP LINE

At Sanyo, fulfilling the needs of our customers is a priority. That's why we created our SOS customer service program that guarantees satisfaction.

### NATIONWIDE CUSTOMER SUPPORT

SOS is there to help you. Our friendly and knowledgeable product specialists will quickly answer your questions about setup and use of Sanyo telephone products. Simply call toll free from anywhere in Canada to connect to our no-charge, SOS support and service network:

**1-800-263-2244**  
**between 8:30 am – 7:00 pm EST**

Or visit our website at [www.sanyoservice.com](http://www.sanyoservice.com), and click the **Customer Relations** button to get access to our FAQ's (Frequently Asked Questions) and other helpful features.

### STAY-AT-HOME CONVENIENCE

It's a nuisance making another trip to the store when you're stuck. Now with SOS, all that's necessary is a quick call from your home for product assistance.

### HASSLE-FREE EXCHANGE

Should your Sanyo telephone require servicing due to a manufacturing defect during the warranty period, SANYO Canada will ship prepaid a replacement unit\* within two business days after receiving your defective unit. **Consumers are responsible for the shipping costs of the unit back to Sanyo.**

- For older, non-current models, replacement units may not be available, in which case our regular warranty conditions will apply.

### GUARANTEED QUALITY

All SOS replacement sets are checked and serviced by factory-authorized technicians before being sent out.

SOS means you never have to worry.

C.O.D. and/or Collect shipments will not be accepted.

Unit must be returned to Sanyo in its original box with all accessories, i.e.: owner's manual, battery, adaptor, telephone cord, etc.

E42

**Memo**

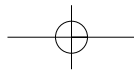
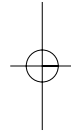
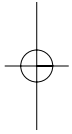

**Memo**

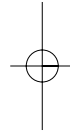
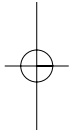

**E44**

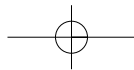

**Memo**

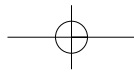
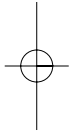

**SANYO**

**Covered under one or more of the following U.S. patents:**

4,523,058	4,595,795	4,797,916	5,381,460	5,426,690
5,434,905	5,491,745	5,493,605	5,533,010	5,574,727
5,581,598	5,650,790	5,660,269	5,661,780	5,663,981
5,671,248	5,696,471	5,717,312	5,732,355	5,754,407
5,758,289	5,768,345	5,787,356	5,794,152	5,801,466
5,825,161	5,864,619	5,893,034	5,912,968	5,915,227
5,929,598	5,930,720	5,960,358	5,987,330	6,044,281
6,070,082	6,125,277	6,253,088	6,314,278	6,418,209

**All rights reserved**

**UCZZ01015DZ**

**Printed in China**



## Free Manuals Download Website

<http://myh66.com>

<http://usermanuals.us>

<http://www.somanuals.com>

<http://www.4manuals.cc>

<http://www.manual-lib.com>

<http://www.404manual.com>

<http://www.luxmanual.com>

<http://aubethermostatmanual.com>

Golf course search by state

<http://golfingnear.com>

Email search by domain

<http://emailbydomain.com>

Auto manuals search

<http://auto.somanuals.com>

TV manuals search

<http://tv.somanuals.com>