



INSTRUCTION MANUAL

CLT-D6720

Digital Cordless and Coded Telephone combo with Digital Answering System

touch
dect 6.0

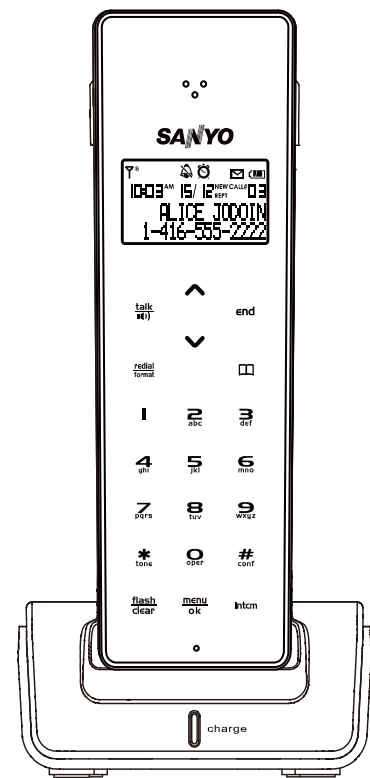
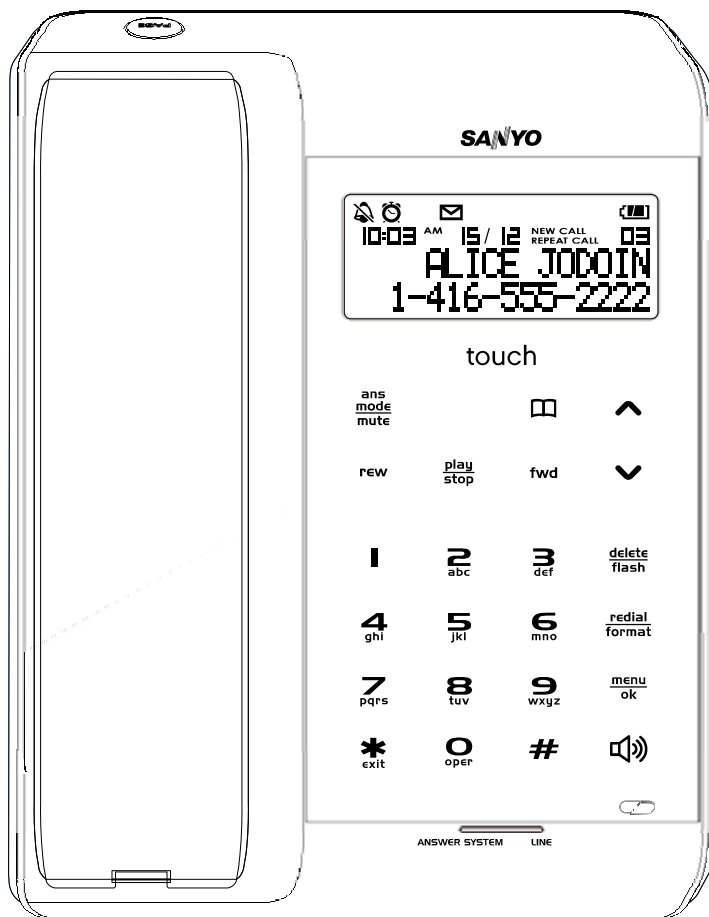

IMPORTANT

Charge the handset battery pack 15+ hours before using your cordless handset for the first time

INSTALL NOW: 3 AA alkaline batteries (not included) in base for power failure back-up

TOLL-FREE help line: 800-263-2244 (Monday-Friday 9-5 Eastern time)

=====

IMPORTANT SAFETY INSTRUCTIONS

When using your telephone equipment, basic safety precautions should always be followed to reduce the risk of fire, electric shock and injury to persons, including the following:

1. Do not use this product near water, for example, near a bath tub, wash bowl, kitchen sink or laundry tub, in a wet basement or near a swimming pool.
2. Avoid using a telephone (other than a cordless type) during an electrical storm. There may be a remote risk of electric shock from lightning.
3. Do not use the telephone to report a gas leak in the vicinity of the leak.
4. Use only the power cord and batteries indicated in this manual. Do not dispose of batteries in a fire. They may explode. Check with local codes for possible special disposal instructions.

5. CAUTION

**RISK OF EXPLOSION IF BATTERY IS REPLACED BY AN INCORRECT TYPE.
DISPOSE OF USED BATTERIES ACCORDING TO THE INSTRUCTIONS.**

**USE ONLY WITH (BRAND NAME: SANIK MODEL NO: 3SN-AAA65H-S-F ;
(3.6V 650mAh) NiMH rechargeable battery)**

SAVE THESE INSTRUCTIONS

=====

CONTENTS

INTRODUCTION	4
Main features	4
Package contents	4
NAMES AND CONTROLS	5
Base unit – front view.....	5
Base unit – bottom view and wall mount bracket.....	6
Touch cordless handset – front view.....	7
LCD Display symbols	8
SAFETY AND CARE	8
Safety precautions	8
Caring for your product	8
Caution.....	9
GETTING STARTED	10
Connecting power and phone line	10
Installing batteries	10
Low battery warning.....	12
Attaching the belt clip.....	12
Wall mounting the base unit.....	12
Base-to-cordless handset reception	13
PHONE MENUS	13
Status and messages	13
Navigating the phones' main menu.....	14
Base unit menus	15
Cordless handset menus	16
BASIC FUNCTIONS	18
Standby and sleep mode	18
Making and receiving calls.....	18
PHONEBOOK	20
Using keys to enter text	20
Storing numbers.....	21
Editing numbers	21
Calling stored numbers	21
Deleting numbers.....	22
CALLER ID	22
Viewing / calling Caller ID records	22
Deleting 1 or all Caller ID records	22
Saving Caller ID records in phonebook	23
Editing Caller ID number before dialing	23
Formatting Caller ID numbers.....	23
Missed calls	23
Message Waiting	23
FUNCTION SETTINGS	24
Change display settings.....	24
To assign a name to a handset - cordless handset only	24
Change ring and key tones	25

CONTENTS

Tone/Pulse setup	25
Flash time	26
Smart Key Lock – cordless handset only.....	26
Manual Key Lock	26
Change area code	26
Baby call	26
Auto answer – cordless handset only	27
SPECIAL FEATURES.....	27
Clock and alarm settings.....	27
Base-to-handset calling	28
Registration.....	29
DIGITAL ANSWERING SYSTEM	29
Menu options	30
ANSWERING SYSTEM FUNCTIONS – BASE UNIT ONLY	30
Announcements.....	31
Ring delay	32
Screen calls	32
Remote access to the answering system	33
Memory full	34
RESET.....	34
DEFAULT SETTINGS	34
ADDING MORE CORDLESS TOUCH HANDSETS	35
TROUBLESHOOTING	35
CHANGING THE BATTERY–CORDLESS HANDSET ONLY	36
Battery replacement and handling	36
Make sure the telephone is off before you replace the battery	36
POWER FAILURE.....	36
RECYCLING NICKEL-METAL HYDRIDE BATTERIES	36
HEADSET JACK.....	37
MAINTENANCE	37
MAXIMIZE BATTERY PERFORMANCE	37
SPECIFICATIONS.....	38
TECHNICAL INFORMATION.....	39
SANYO COMFORT WARRANTY.....	40
SOS HELP LINE	42

INTRODUCTION

Congratulations on your purchase of this SANYO Combo Touch – Corded/Cordless Telephone with Digital Answering System. It is the complete home or SOHO (Small Office/Home Office) solution offering you a stylish phone with an innovative keyless touch sensing technology that enhances your experience.

Main features

- World's 1st keyless touch sensing technology
- Motion sensor detects hand movement for keypad auto-triggering
- Latest DECT (Digital Enhanced Cordless Telephone) platform will not interfere with microwave ovens, wireless routers, baby monitors, etc
- Exclusive Confidential Conversation mode blocks audio from other phone in the combo system (either corded or cordless) during an active call, until "invited"
- 60 phonebook records with search and edit function
- Records last 20 numbers
- Stores 40 incoming Caller ID records
- Visual Call Waiting (phone company subscription required) with flash button and adjustable flash time to match any phone company characteristics
- Only 1 phone jack required
- Intercom / Call transfer
- Conference between handset and corded phone on base
- Message waiting / Missed calls notification
- Clock / Alarm functions

Corded base unit:

- 5 ring tones
- Multiple language display
- Tapeless Digital answering system with 13-minute capacity of up to 50 messages
- Personalized or preset outgoing message and call screen function
- Remote access to the answering system

Cordless handset:

- Smart key lock to avoid false keypad touch when talking
- Handset speakerphone
- Standby time – 120 hours / Talk time – 5 hours

Package contents

Make sure your package includes one of each of the following items:

Corded base unit

- Base unit with handset and answer system
- Base unit wall-mount bracket
- Base unit AC adapter (Model No.: UD4120080050G)
- Telephone line cord and coil cord

Cordless handset

- Handset charger
- Handset rechargeable, high-performance NiMH battery pack (Pre-installed)
- Belt clip
- AC adapter for charger (Model No.: DPX351314)

General items

- User manual
- Cleaning cloth

NOTE: Keep this manual handy as you use your new product. It contains practical step-by-step instructions, as well as technical specifications and warnings.

NAMES AND CONTROLS

Base unit – front view

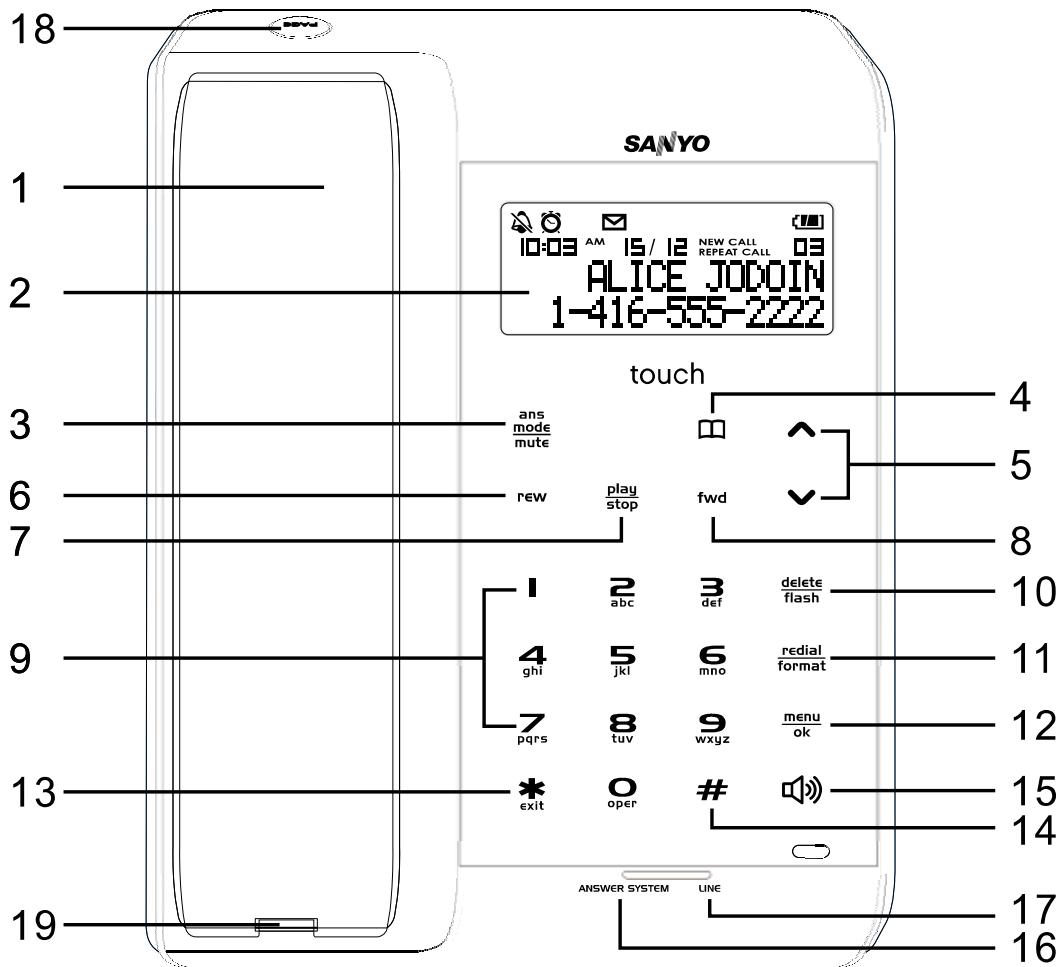

1. Handset
2. LCD Display
3. : Answering system mode / Mute and un-mute the microphone
4. : Phonebook
5. and : Volume control / View caller ID log / Navigate menus and settings
6. : Rewind message
7. : Play / Stop message
8. : Forward message
9. Keypad: Alphanumeric keypad
10. : Delete text / Activate call waiting mode / Exit submenu
11. : Redial previous number / Format area code or long distance numbers
12. : Access main menu / Confirm setting / Call transfer
13. : Special character / Exit to Standby mode
14. : Toggle between upper and lower case
15. : Enables speakerphone
16. **ANSWER SYSTEM LED**: Answering system mode indicator
17. **LINE LED**: Line in use indicator
18. **PAGE**: Pages handset
19. Handset coil cord jack

NAMES AND CONTROLS

Base unit – bottom view and wall mount bracket

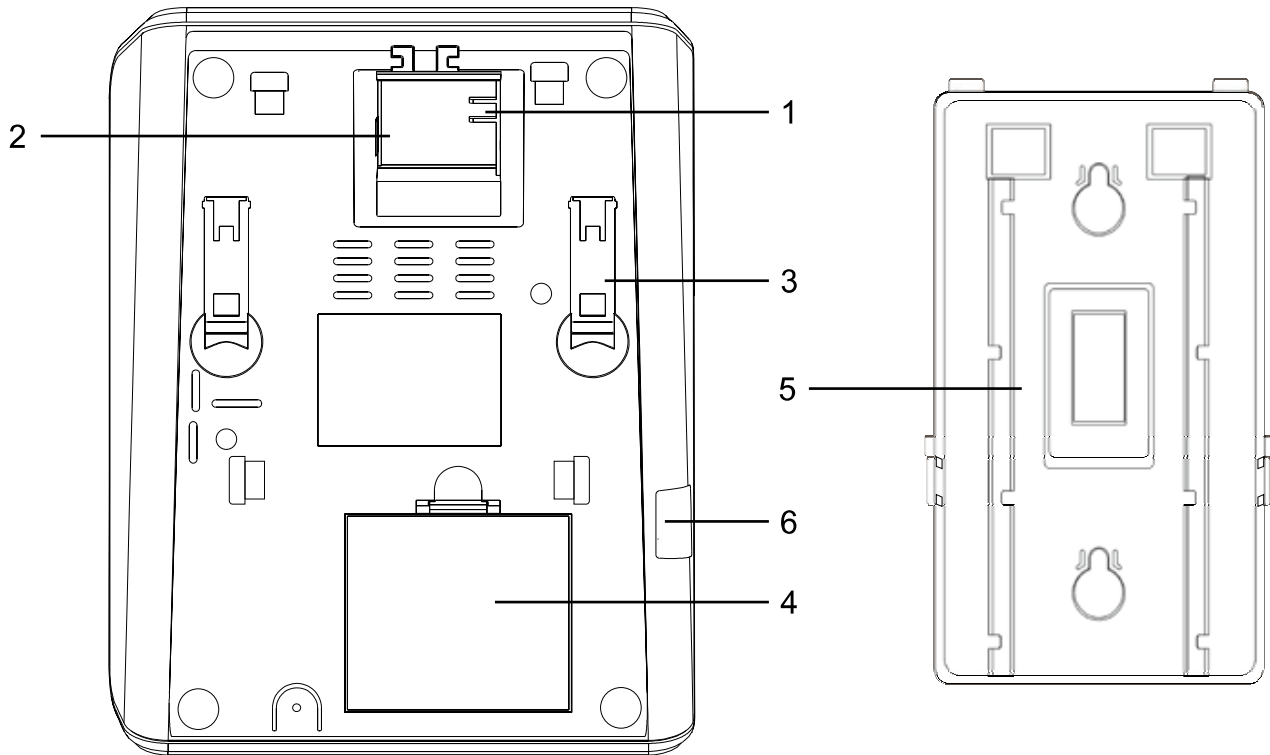

1. Telephone line socket
2. AC adapter jack
3. Folding support legs
4. Battery compartment for power failure back up
5. Wall mount bracket
6. Base coil cord jack

NAMES AND CONTROLS



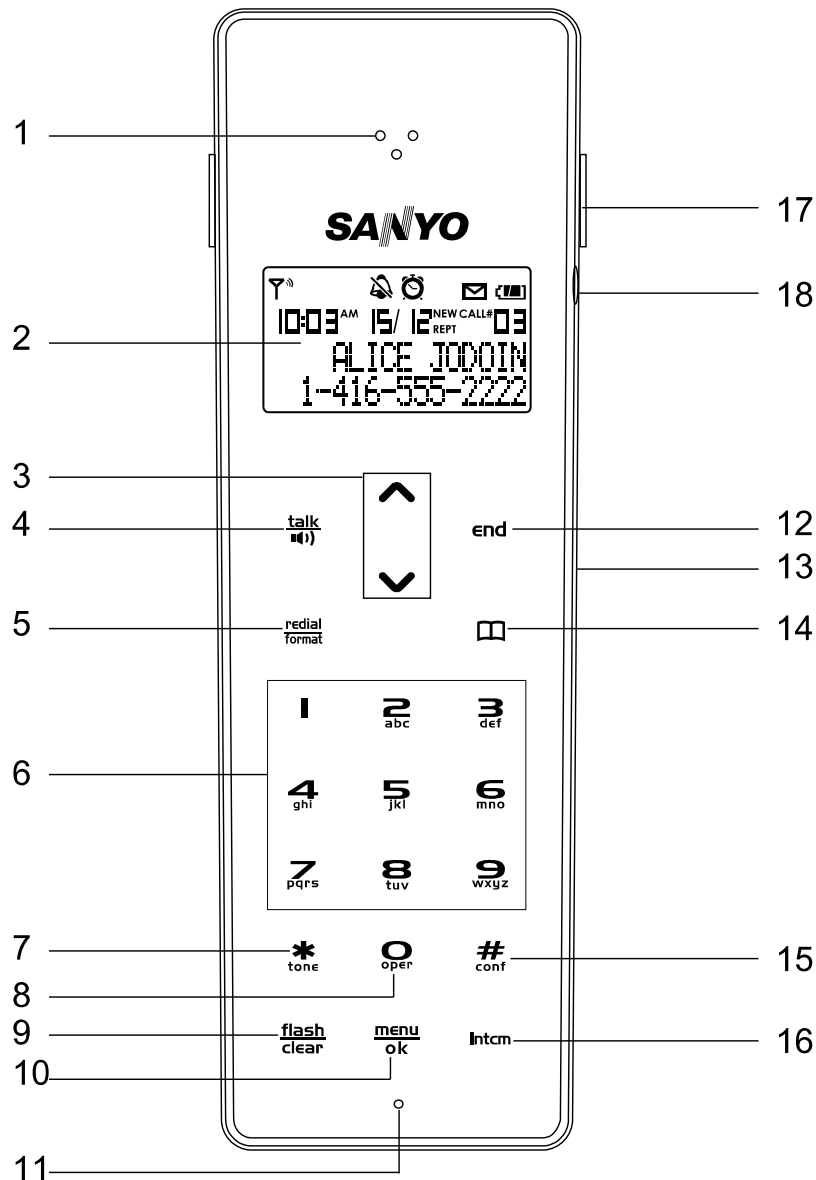









Touch cordless handset–front view



1. Receiver
2. LCD Display
3. and : Volume control / Views caller ID log /Navigate menus and settings
4. : Answers and dial calls
5. : View, dial previous calls / Format area code/ Long distance numbers
6. **1-9**: Enter numbers and characters
7. : Enter special characters
8. : Enter numbers and special characters
9. : Activate call waiting / Delete text / Exit submenu
10. : Access the main menu / Confirm setting / Manual key lock / Mute function during a call
11. Microphone
12. : End calls / Exit to Standby mode
13. Speaker
14. : Enter phonebook
15. : Toggle between capitals and small letters when entering text
16. : Intercom – Dial internal line
17. Detachable belt clip
18. Headset jack

NAMES AND CONTROLS

LCD Display symbols

ICON	DISPLAY
	Ringer silenced
	Alarm set
	Lowercase mode activated
	Message waiting
	DTAM mailbox new message present / (blinking) Mailbox is full (For base only)
	Phonebook menu is entered (For base only)
	Speakerphone on (For base only)
	AC Power off (For base only)
	Battery level
	Date and time
	Call counter
	New / Repeat call indicator

SAFETY AND CARE

Observe the following safety precautions and warnings when setting up and using this product.

Safety precautions

- LCD panel – The LCD panel is made of glass and may break if the unit is dropped. Place the unit securely on a stable surface.
- Heat sources – Keep the product away from heat sources, such as radiators, stoves, heaters, and other heat-generating products.
- Water and moisture – Do not use the product in or near water or in high moisture areas, such as a bathroom.

Caring for your product

- Do not clean any part of your phone with benzene, thinner or other solvent chemicals as this may cause permanent damage that is not covered by the warranty. When necessary, clean it with a damp cloth.
- Keep your phone away from hot, humid conditions or strong sunlight.
- Never immerse the unit in water or use your phone outdoors in the rain, or handle it with wet hands.

SAFETY AND CARE

- Do not subject the base unit to extreme force, shock, or fluctuations in humidity.
- Do not tamper with the internal components or disassemble the unit.
- Every effort has been made to ensure the highest standards of reliability for your phone. However, if something does go wrong, do not try to repair it yourself – consult your supplier.
- Do not dispose this product as unsorted municipal waste. Collection of such waste separately for special treatment is necessary.

Caution

- Dispose of old, defective battery pack in an environmentally friendly manner in accordance with the relevant legislation.
- No naked flames, such as lighted candles, should not be placed near the apparatus.
- **Never** use your phone in the open air during a thunderstorm. Unplug the base unit from the phone line and the main socket when there are storms in your area.
- **Do not** install the base unit near a sink, bath or shower, or anywhere else where it could get wet. Electrical equipment can cause serious injury if used while you are wet or standing in water.
- If the base unit ever falls into water, **do not** retrieve it until you have unplugged the power lead from the mains and the phone line plug from the phone socket; then pull it out by the unplugged cables.
- When handling the battery pack exercise care. Contact with conductive materials can short the battery pack.
- Use only the power source marked on the power supply (adapter). If you are unsure of the power supplied to your home, consult your power company. **Do not** place objects on the power cord.
- **Never** use this unit near a gas leak as this can cause explosions.
- Occasional loss of synchronization between the handset and base unit is normal if there is significant interference from the surrounding environment.
- Disconnect the telephone line from the wall-outlet before replacing the battery pack.

GETTING STARTED

Connecting power and phone line

Base unit

1. Plug the AC adapter (Model No.: UD4120080050G) into the POWER DC 8V jack on the bottom of the base. Plug the other end into a standard 120V AC wall outlet.
2. Plug the telephone line cord to the TEL LINE jack on the bottom of the base. Plug the other end into a telephone outlet.
3. Connect the coil cord to the base and the corded handset.

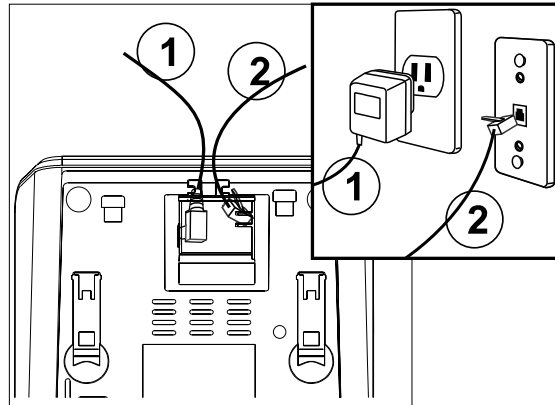

NOTE: During initialization, the base unit **LED** will flash and beep. Once complete, the unit will be in Standby mode.

Cordless unit

Plug the AC adapter (Model No.:DPX351314) into the POWER DC 6V jack on the back of the charger. Plug the other end into a standard 120V AC wall outlet.

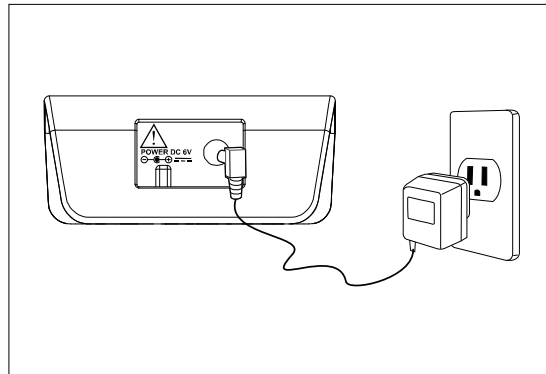

NOTE: Make sure the adapter and phone line socket outlets are easily accessible and near the equipment.

CAUTION: Use only the SANYO AC adapter with these phones. Using another AC adapter may damage the phone.

If the product is to be used on a phone line that also has broadband (ex- Bell Sympatico hi-speed, etc), then an ASDL micro-filter must be connected. Otherwise, the product and broadband may have noise problems.

Installing batteries

Base unit

The base unit uses 3 x AA size alkaline batteries (not included) as a power backup. In case of

GETTING STARTED

power failure, the batteries will keep the settings of the base unit for approximately five hours.

NOTE: Do not use rechargeable batteries as they will lose all their charge in 3 months even if not used. The base unit DOES NOT CHARGE batteries.

To install the base unit batteries:

Disconnect all telephone lines from equipment before replacing batteries.

1. Open the battery compartment.
2. Insert the batteries, noting the polarity (+ and -) as shown.
3. Close the compartment.

CAUTION:

1. Use only the specified battery.
2. Do not mix different types of batteries together (e.g. Alkaline and Carbon-Zinc) or old batteries with fresh ones.
3. If they are not to be used for a long period of time, remove the batteries to prevent damage or injury from possible batteries leakage.

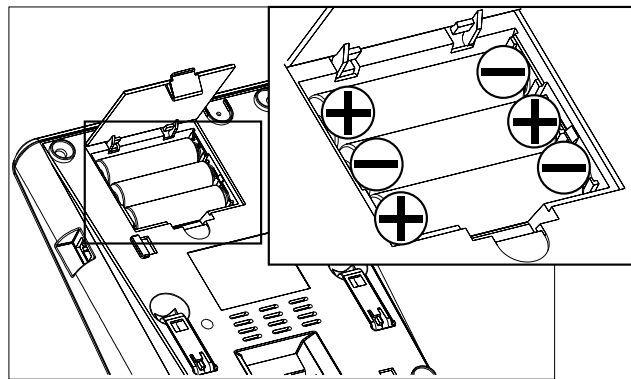

Cordless handset

The handset uses 1 high-performance NiMH 650 mAh 3.6V (AAA) rechargeable battery pack.

To charge the battery pack:

1. The removable battery pack is already pre-installed, simply gently pull out the insulation tab.
2. Place the handset in the cradle of the charger
3. The battery icon will flash and the charge indicator light will turn on to show it is charging.



4. To prolong battery life, charge the handset for at least 15 hours prior to first use.
- When the battery is fully charged, the battery icon will stop flashing and  will appear.

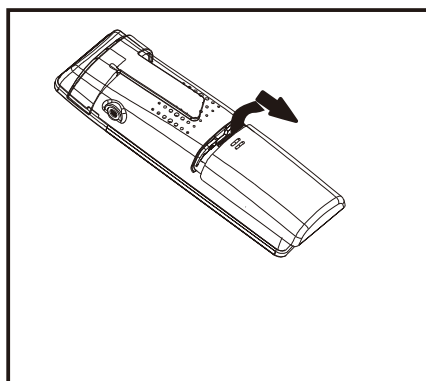

WARNING: There is a risk of explosion if the battery pack is replaced with the incorrect battery pack type. Dispose of the used battery pack according to the instructions.

GETTING STARTED

Low battery warning

The battery icon indicates the battery status:



When the handset battery is low, **LOW BATTERY** will appear on the screen of handset.

Attaching the belt clip

Belt clip installation

1. Attach the belt clip by inserting the sides of the belt clip into the slots.
2. Snap the ends of the belt clip into place.

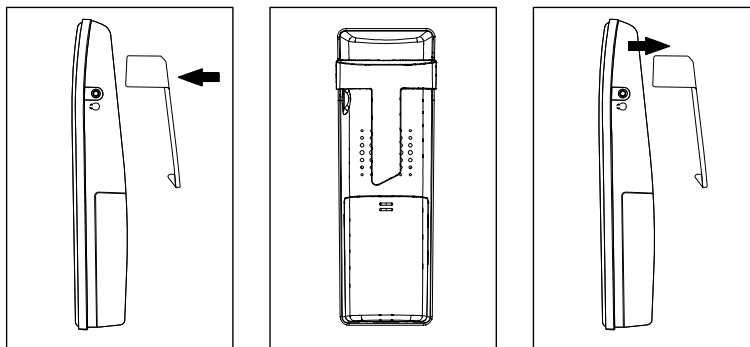

Wall mounting the base unit

1. Thread the phone line and adapter cords through the mounting bracket.
2. Plug the phone line and adapter cords into the sockets on the base unit.
3. Insert the hooks of wall mount bracket to the slots at the bottom of the base.

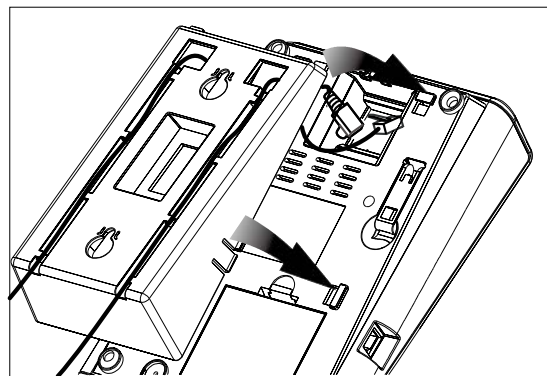
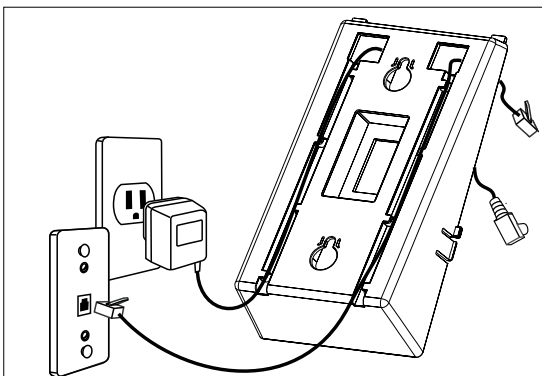

4. Remove the small wall mount hanger in the base cradle. Rotate it 180° and clip it back into the slot.

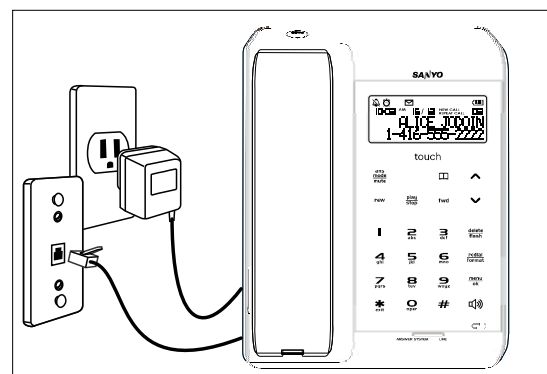
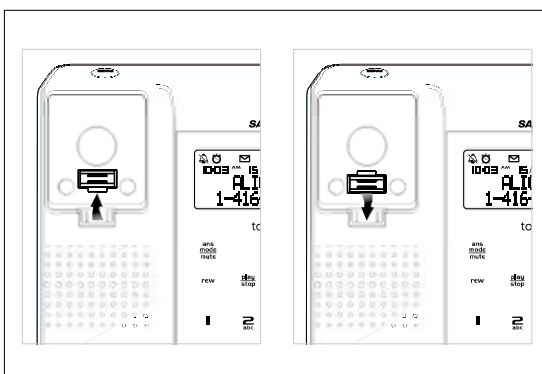

GETTING STARTED

5. Mount the bracket onto 2 nails on the wall and plug in the phone line and adapter cords.

NOTE: If the cords are too long, you can fasten them with a wire tie and store them under the base.

Base to cordless handset reception

The range of your base to cordless handset will depend mainly on the type of building construction in your home or office. In a wood structure, usually expect 3-floor coverage in about a 20 meter radius. Concrete walls and floors will limit the range more than wood. You may need to experiment with the location of the base. If you are out of range or the signal is interrupted  will disappear and OUT OF RANGE will be displayed.

NOTE: Due to essentially 2-way radio characteristics, occasional loss of synchronization between the cordless handset and base unit may occur. If this happens the base unit will very quickly switch to another channel automatically to restore synchronization.

PHONE MENUS









Status and messages

The following table gives a list of the possible statuses of the telephone or messages that are displayed during a function.

MESSAGES	DESCRIPTION
HH:MM	In Standby mode, the time shows.
MEMORY FULL	The memory is full. No additional record can be saved unless some records are deleted first.
XX MISSED CALLS	Shows the number of missed calls. The call log can be consulted to see the caller ID. NOTE: When viewing the Caller ID of the missed calls, the following will show: <ul style="list-style-type: none">• NEW CALL shows that the call has not been viewed previously.• REPT or REPEAT CALL shows that the repeat call has not been viewed previously.
xx NEW MESSAGES	Shows the number of new messages in the mailbox.
EXTERNAL CALL	The message shows when an incoming call arrives.
TALK HH:MM	Shows the duration of the conversation.
TALK	Talk mode.
MUTE	Mute mode.









PHONE MENUS

Navigating the phones' main menu

KEY		FUNCTION
Base Unit	Cordless Handset	
		To access the menu, enter a menu option or confirm the selection of a value.
		To scroll up / down through current menu and submenu.
		To exit the main menu or return to the previous menu level.
		To exit and return to Standby mode.

How to navigate menus:

During Standby mode

1. Touch  to enter the main menu or submenu.
2. Use  and  to scroll through the menu options. The keypad can also be used to directly enter the number corresponding to the submenu option. The icon  indicates the menu option or setting to be selected.
3. Touch  to confirm or select the next menu option. After confirmation of a setting, it will return to the previous menu level.
4. Touch  on the cordless handset or  on the base unit to exit to the previous menu.
5. Touch  on the cordless handset or  on the base unit to exit all menus.

NOTE:

- You cannot enter the menu if you are making a call or have pre-dialed any part of a phone number.

PHONE MENUS

Base unit menus

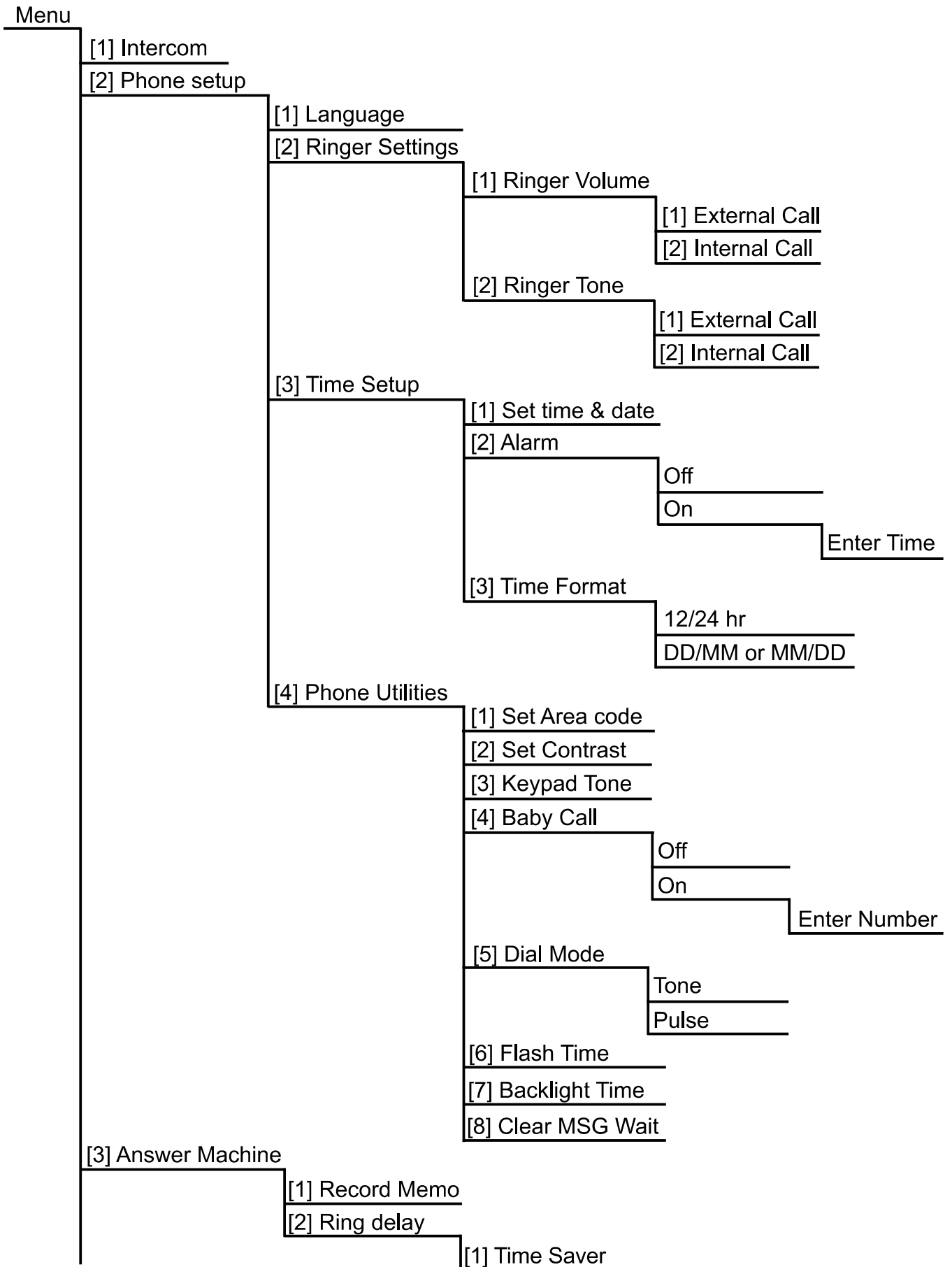

PHONE MENUS

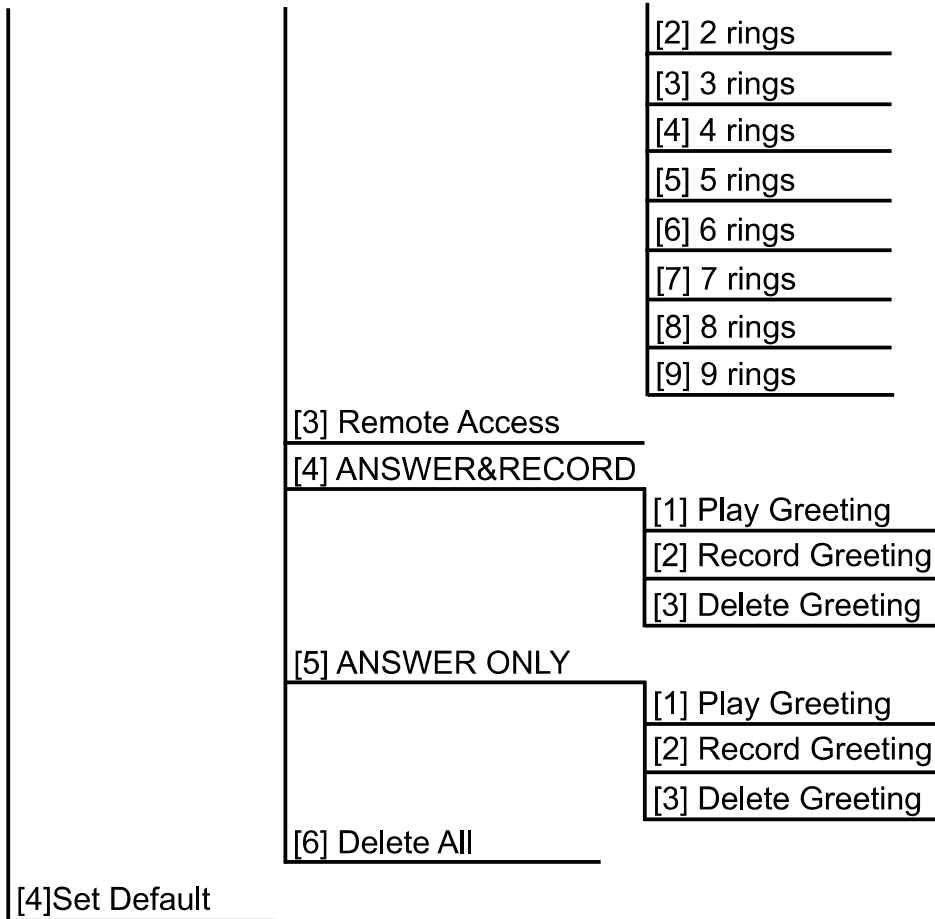

NOTE: The number in brackets [x] is a shortcut key that can be directly touched on the keypad to directly navigate to the sub-menu options.

Cordless handset menus

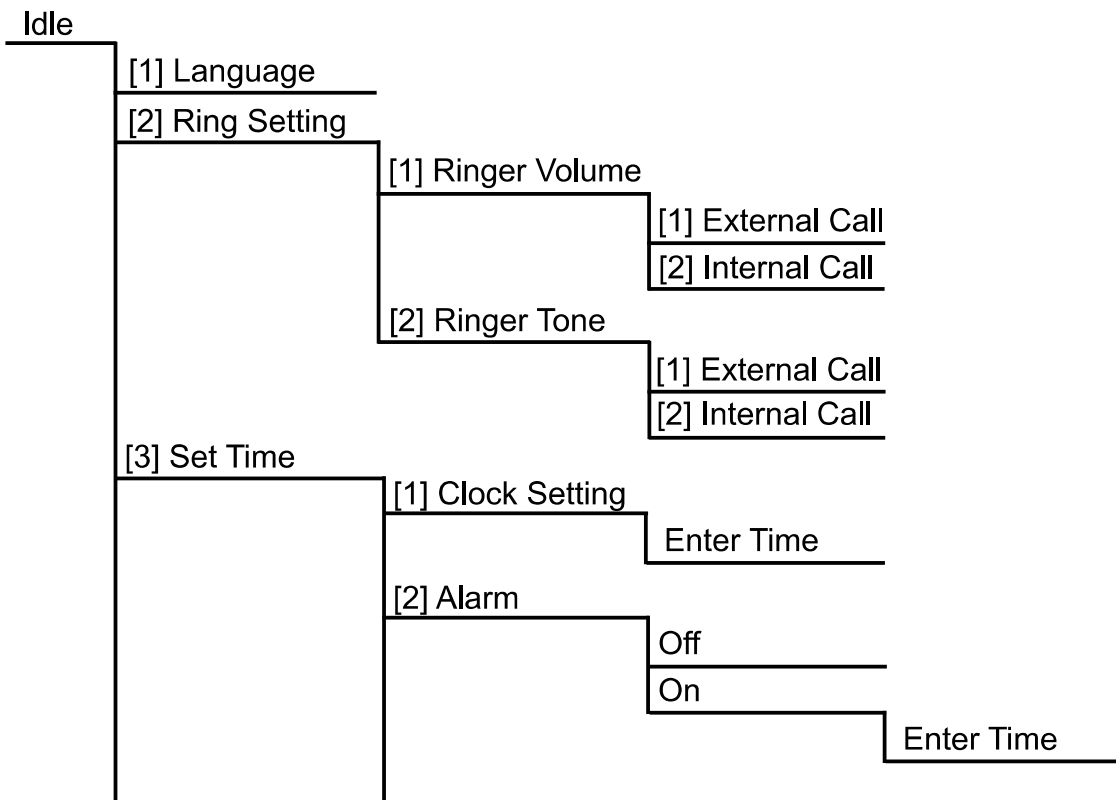

PHONE MENUS

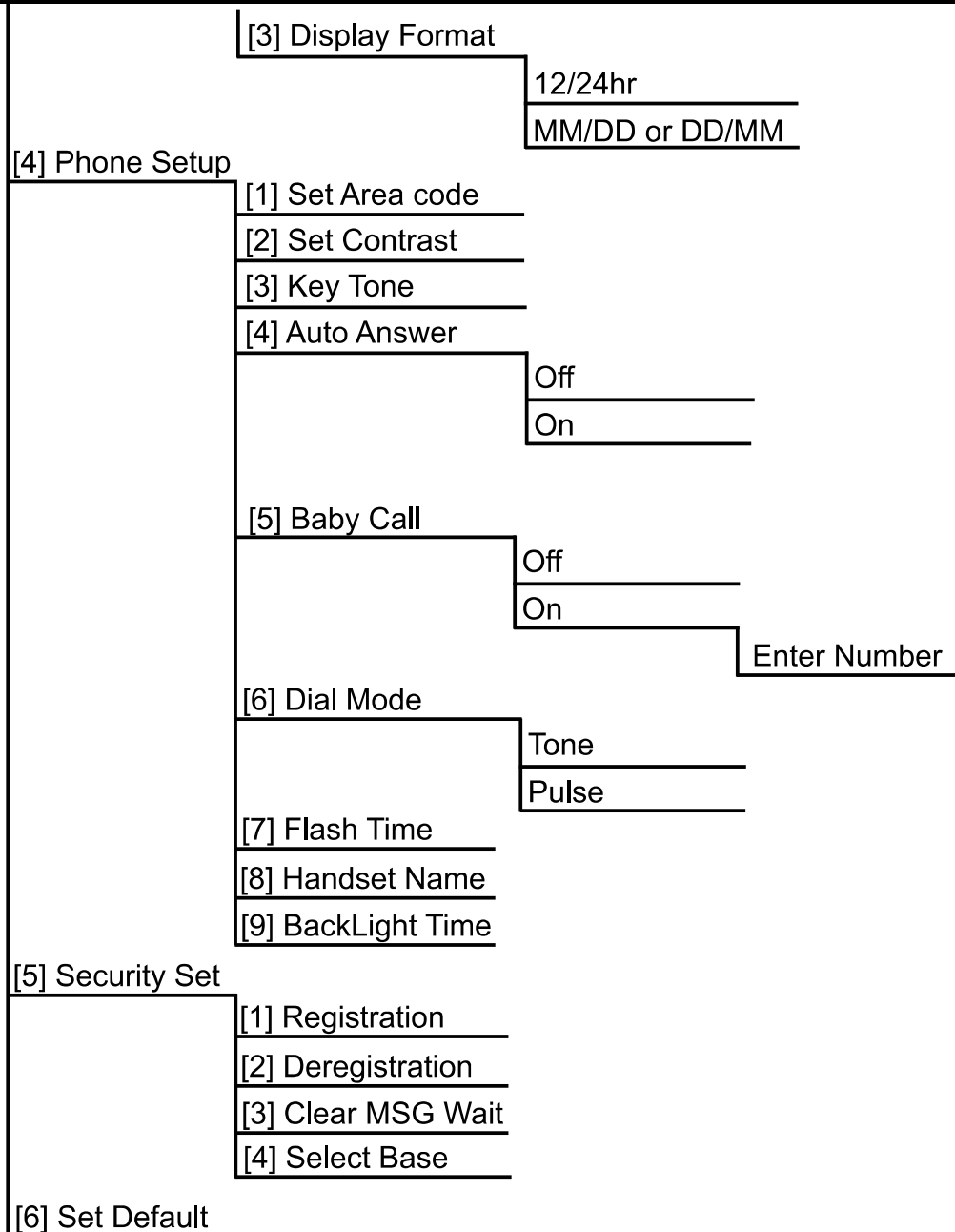

NOTE: The number in brackets [x] is a shortcut key that can be directly touched on the keypad to directly navigate to the sub-menu options.

BASIC FUNCTIONS

Standby and sleep mode

Corded phone with base unit

The phone includes a motion sensor that will detect object movement in proximity of the base unit. Upon detection, the keypad's backlight will automatically activate to show the phone is no longer in sleep mode.

Cordless handset



When the handset has been inactive for a while, it will enter sleep mode. The LCD backlight and key lights will switch off. Press any key to return to standby mode and turn the handset lights on again.

To adjust the time from Standby to Sleep mode, refer to **CHANGE DISPLAY SETTINGS – Backlight Time setting** on page 24.

Making and receiving calls





To make a call:

You may make a call by using one of the following methods:

1. Lift the handset from the charger and touch  or pick up the corded phone from the base.
2. Enter the desired phone number using **0-9**. If you make an error. Touch  on the handset or place the corded handset back to the base cradle to cancel.
3. If you are using the handset, touch  to hang up.
If you are using the corded phone, put the phone back into the base cradle to hang up.

To pre-dial a call:

You may pre-dial the number before you touch  on the handset or  on the base.

1. Dial the number. If you make an error, touch  on the handset or  on the base unit to delete the wrong numbers and re-enter.
2. Touch  on the handset, or  on the base, or pick up the corded phone to dial.

To insert a pause:

When entering a phone number, touch . A 3-second pause will be inserted before dialing the next digit. "P" will appear on the display.

To answer a call:

- Touch  on the handset. (If **AUTO ANSWER** is set to **ON**, simply pick the handset up from the charger.)
- Lift the corded phone from the base.



NOTE: When making or answering calls bring the top of handset (receiver) to your ear before speaking. Once the receiver has made contact with your ear, the handset's Smart Key Lock function will automatically lock the handset keys and you may bring the bottom of the handset (microphone) closer to your lips and speak into the microphone. Handle the handset with care to avoid accidentally triggering the keys. If you encounter difficulties, there is also a manual Key Lock (see **MANUAL KEY LOCK** section for more details on page 26).

To end a call:



- Touch  on the handset or place it back in the charger.
- Put the corded phone back into the base cradle.

BASIC FUNCTIONS

To activate speakerphone:

1. When you are on a call and in Talk mode, **TALK** displays. To activate the speakerphone, touch  on the handset or  on the base unit and then place the corded phone back to the base unit.
2. Touch  on the handset, or lift the corded phone from the base to deactivate the speakerphone.

OR



1. When the base unit receives an incoming call, you can simply press  to answer the call using the speakerphone.
2. Press  again to turn it off.

To adjust the volume during a call:

Touch  or  to raise or lower the volume .





To redial a call:

To redial the last dialed number:

1. Touch  then  on the handset, or pick up the corded phone and touch  .





OR

To redial one of the previous 20 dialed numbers:

1. Touch  .
2. Use  and  to select the desired phone number.
3. Touch  on the handset, or pick up the corded phone, or touch  on the base unit to start the call.





To mute the microphone during a call:

To have a private off-line conversation, use the **MUTE** feature. The caller on the other end of the line cannot hear you, but you can still hear them.



1. Touch  on the handset or  on the base unit.
2. Touch  or  again to return to your phone conversation.

To pick up a waiting call:

When you are on a call and another call arrives, the call waiting beep will sound.

1. Touch  on the handset or  on the base unit to answer the incoming call and place your existing call on hold.
2. Touch  or  to toggle between calls.

If there is a problem with the Flash function, the solution is usually to adjust the interval time to your phone company's settings:

- On the handset, touch  > PHONE SETUP > **FLASH TIME**.
- On the base unit, touch  > PHONE SETUP > PHONE UTILITIES > **FLASH TIME**.

NOTE: You must subscribe to Caller ID with Call Waiting Service from your local phone company to use this function.

Handset locator (Paging function):

This feature helps to locate a misplaced handset.

1. Press PAGE on the base, the screen shows 'PAGING'. The handset beeps continuously for about 2 minutes or until you touch any key on the handset.

BASIC FUNCTIONS





2. To stop the paging, do one of the following:

- Press PAGE on the base.
- Touch  to enter talk mode.
- Touch any keys on the handset.

PHONEBOOK









The phonebook can store up to 60 different phone numbers on each phone. The numbers can be as long as 24 digits and the names up to 16 characters.

To access the phonebook menu options:

1. Touch .
2. Touch .
3. Navigate the menu using  or .



Using keys to enter text

Characters are entered by touching the **0-9** and  keys. A consecutive touch of the same key will enter a different character according to the table below:





KEY	CAPITAL LETTERS	SMALL LETTERS
1	SPACE 1 _ - + = ^ . , ; :	SPACE 1 _ - + = ^ . , ; :
2	ABC2ÀÁÂÃÄÅÆÇ	abc2àáâãäåæç
3	DEF3ÈÉÊË	def3èéêë
4	GHI4ÌÍÎ	ghi4ìíî
5	JKL5	jkl5
6	MNO6ÒÓÔÕÖØÑ	mno6òóôõöøñ
7	PQRS7	pqrs7
8	TUV8ÙÚÛÜ	tuv8ùúûü
9	WXYZ9ÝÞ	wxyz9ýþ
0	0 ' " () [] < > { }	0 ' " () [] < > { }
Base unit	Cordless Handset	
 exit	 tone	* # ? ! \$ % / \ ~
 #	 #	Change between capital and small letters
 delete flash	 flash clear	To delete the previous character
 menu ok	 menu ok	To enter text
	 end	To exit to standby mode

PHONEBOOK

Storing numbers

1. Touch .
2. Touch . The cursor is pointing to **ADD RECORD**.
3. Touch  to confirm.

NOTE: When the memory is full, you will hear a beep and **PHONEBOOK FULL** appears. You will need to delete a contact before you proceed.













4. Enter the name using **1-9** (see **TO INPUT NAMES** below).
5. Touch  to confirm and save name.
6. Enter the number using **1-9**, , .
7. Touch  to save the entry.

NOTE: A number can be saved without entering a name.





To input names:

1. Touch a number key (**0-9**) repeatedly within 1 second until the desired character appears.
2. Touch a different key to input the next character. If the next character uses the same number key, you must wait for 1 second until the cursor moves to the next digit. Then touch the same number to input the character.
3. Repeat steps 1 and 2 until the name is entered.

Editing numbers

1. Touch .
2. Use  or  or the alphabetical keypad to select the entry you wish to edit.
3. Touch  to confirm.
4. Use  or  to select **EDIT RECORD**.
5. Touch  to confirm.
6. To edit the name:
 - Touch  on the handset or  on the base unit to delete characters.
 - Use  or  to move the cursor left or right.
 - Touch **0-9** to insert new characters.
7. Touch  to save.
8. Repeat steps 6 and 7 to edit the number.









Calling stored numbers

1. Touch . The first number in the phonebook will be displayed.
2. To quickly access a record, enter the 1st letter of the name searched using the keypad.
OR
Touch  or  to scroll to the entry you want.
3. Touch  on the handset or  on the base unit to start dialing.







PHONEBOOK

Deleting numbers

To delete 1 record:

1. Touch .
2. Touch  or  or alphabetic search to select the record you want to delete.
3. Touch  to confirm.
4. Use  or  to select **DELETE RECORD**.
5. Touch  to confirm, **DELETE ?** or **DELETE RECORD?** shows on the screen.
6. Touch  to confirm.

To delete all:

1. Touch .
2. Touch .
3. Use  or  to select **DELETE ALL**.
4. Touch  to confirm, **DELETE ALL?** shows on the screen.
5. Touch  to confirm.





CALLER ID

You must subscribe to the Caller ID service through your local telephone company to activate this feature. Caller ID will show you the name and / or number of the caller if you have their details in your phonebook. Up to 40 incoming caller IDs can be stored in the call log.





NOTE: If you answer a call before the second ring the caller information may not be stored. If the call log memory is full, the new call automatically replaces the oldest call in the memory.

Viewing / calling Caller ID records







To view the caller IDs:

1. In Standby mode, touch  or  to view all call log entries. The number of new and total calls will be displayed.
2. Touch  or  to navigate to any number in the call log. If there are no records in the call log, **NO CALLS** will appear.





To dial a number in the call log:

1. Touch  or  to select the desired number.
2. Touch  on the handset or  on the base unit to dial.

Deleting 1 or all Caller ID records

1. Touch  or  to view the call log (to delete all entries skip to step 3).
2. **To delete 1 Caller ID:**
 - Use  or  to select the Caller ID you wish to delete.
 - Touch  on the handset or  on the base unit.
 - Touch .

OR









- Touch .
- Use  or  to select **DELETE RECORD**.
- Touch  to confirm selection.
- Touch  again to delete.

CALLER ID











3. To delete all Caller IDs:

- Touch  or , then touch .
- Use  or  to select **DELETE ALL**.
- Touch  to confirm. '**DELETE ALL?**' shows on screen.
- Touch  again to delete all.





Saving Caller ID records in phonebook

1. Touch  or  to review the call log.
2. Touch  or  to select the number you wish to save.
3. Touch  to enter the call log menu. The cursor points to **ADD RECORD**.
4. Touch  to confirm.
5. Touch  to confirm the name (if necessary, use the keypad to edit the name).
6. Touch  to confirm the number and save it in the phonebook (if necessary, use the keypad to edit the number).



Editing Caller ID number before dialing

1. Touch  or  to review the call log.
2. Touch  or  to select the number you wish to edit.
3. Touch  and navigate to the **EDIT TO DIAL** submenu.
4. Touch  to confirm.
5. Touch  or  to delete the digits. Retype the correct number.
6. Touch  on the handset or  on the base unit to dial.

Formatting Caller ID numbers

1. Use  or  to select a phone number in the Caller ID memory.
2. Touch . The number you selected can be formatted by touching . For example, if the Caller ID number appears 1-416-222-5555 but it is not a long distance number, touch the  key until it shows 416-222-5555, without 1.

Missed calls

During Standby mode, all missed calls will show as follows: **XX MISSED CALLS**. Use  or  to view your missed calls.

- **NEW CALL** indicates that the calls have not been reviewed.
- **REPT** or **REPEAT CALL** indicates that you have received repeat calls from the same number.

Message waiting







If you are connected to a compatible switchbox/PBX, your Touch phone will alert you when a voice mail message has been received.

-  will appear on the handset and base display and the base LINE LED will flash.
- To listen to your messages, follow the instructions given by your telephone company.

NOTE: You must subscribe to this service from your local telephone company.

CALLER ID

To manually clear the message waiting indicators:

1. On the handset, touch  > SECURITY SET > **CLEAR MSG WAIT**.
On the base unit, touch  > PHONE SETUP > PHONE UTILITIES > **CLEAR MSG WAIT**.
2. Touch .
3. Use  or  to select **YES**.
4. Touch  to confirm.

FUNCTION SETTINGS







In addition to the basic functions there are also a number of special features.

Change display settings







The handset can display information in English, Spanish, French, Portuguese, Italian, Dutch, German, Danish, Swedish, Norwegian and Finnish.

The base can display information in English, French and Spanish.







To change language:

1. On the handset, touch  > **LANGUAGE** submenu.
On the base unit, touch  > PHONE SETUP > **LANGUAGE** submenu.
2. Touch .
3. Use  or  to select desired language.
4. Touch  to confirm.



To adjust screen contrast:

1. On the handset, touch  > PHONE SETUP > **SET CONTRAST** submenu.
On the base unit, touch  > PHONE SETUP > PHONE UTILITIES > **SET CONTRAST** submenu.
2. Touch .
3. Use  or  to change contrast level.
4. Touch  to confirm.

To alter backlight time:

1. On the handset, touch  > PHONE SETUP > **BACKLIGHT TIME** submenu.
On the base unit, touch  > PHONE SETUP > **PHONE UTILITIES** > **BACKLIGHT TIME** submenu.
2. Touch .
3. Use  or  to change the backlight time (**20, 30, 40, 50** or **60** seconds).
4. Touch  to confirm.

To assign a name to a handset – cordless handset only

1. Touch  > PHONE SETUP > **HANDSET NAME** submenu.
2. Use 1-9 keys to enter a name. (see **TO INPUT NAMES** page 21).
3. Touch  to confirm.

FUNCTION SETTINGS





Change ring and key tones

The handset has a choice of 10 polyphonic ring melodies and 4 ring tones. The base unit has 5 ring tones. Both phones have 4 key tones.

To change the ring volume:

1. On the handset, touch  > RING SETTING > RINGER VOLUME > **EXTERNAL CALL** or **INTERNAL CALL**.

On the base unit, touch  > PHONE SETUP > RING SETTING > RINGER VOLUME > **EXTERNAL CALL** or **INTERNAL CALL**.





2. Touch  to enter the menu.
3. Use  or  to select volume level **OFF, 1-4**.
4. Touch  to confirm.

NOTE: Volume level **OFF** means **RINGER VOLUME OFF** and  will display to indicate external ring tone is silenced.

To select a ring tone:

1. On the handset, touch  > RING SETTING > RINGER TONE > **EXTERNAL CALL** or **INTERNAL CALL**.





On the base unit, touch  > PHONE SETUP > RING SETTING > RINGER TONE > **EXTERNAL CALL** or **INTERNAL CALL**.

2. Touch  to enter the menu.
3. Use  or  to select the desired ring tone.
4. Touch  to confirm.

To change the keypad tone:

1. On the handset, touch  > PHONE SETUP > **KEY TONE**.

On the base unit, touch  > PHONE SETUP > PHONE UTILITES > **KEYPAD TONE**.

2. Touch  to enter the menu.
3. Use  or  to select the desired key tone level **OFF, 1-4**.
4. Touch  to confirm.





Tone/Pulse setup

To select Pulse or Tone Dial mode:

If you have Touch-Tone service, do nothing as your phone has been set to Tone prior to shipment. If you do not know which type of service you have, contact your telephone company.

1. On the handset, touch  > PHONE SETUP > **DIAL MODE**.

On the base unit, touch  > PHONE SETUP > PHONE UTILITIES > **DIAL MODE**.

2. Touch  .
3. Use  or  to select **PULSE** or **TONE**.
4. Touch  to confirm.

Temporary touch-tone access (*TONE):







This feature enables Pulse service phone users to access touch-tone services offered by banks, credit card companies, etc.

1. Dial the desired number.
2. Touch  after your call is answered.
3. Follow the voice instructions to complete your desired action.
4. Hang up when finished. The phone returns to Pulse service.

FUNCTION SETTINGS

Flash time

To change the flash time:

1. On the handset, touch  > PHONE SETUP > **FLASH TIME**.
On the base unit, touch  > PHONE SETUP > PHONE UTILITIES > **FLASH TIME**.
2. Touch .
3. Use  or  to select a flash time (**100, 270, 300** or **600ms**).
4. Touch  to confirm.









NOTE: Changing the default flash time of 600ms might disable call waiting.





Smart Key Lock – cordless handset only

The Smart Key Lock prevents the accidental activation of the cordless handset's keys during calls. A sensor inside the top of handset where the receiver is located, when your ear touches the receiver and automatically locks the keypad. To ensure the Smart Key Lock function is activated, make sure to place the handset receiver to your ear first before speaking into the handset microphone. Avoid touching the keypad with your fingers until the handset receiver rests on your ear. Smart Key Lock will disengage as soon as you remove the handset receiver from your ear.





Manual Key Lock

To activate/deactivate Manual Key Lock:

- On the handset, in standby mode touch  and then immediately touch .  appears on handset screen to indicate Key Lock is activated. To deactivate manual key lock, touch  then immediately .
- On the base unit, in standby mode touch  and then immediately touch . **KEYLOCK** appears on base screen for 5 seconds to indicate Key Lock is activated. To deactivate manual key lock, touch  then immediately . Key Lock is temporarily deactivated when you pick up the corded phone.

NOTE: Only the menu key functions during Key Lock stage. However, upon receiving an incoming call the  and  key will automatically unlock to enable the answering of the call. Key Lock is temporarily deactivated when an emergency number is dialed and  or  is pressed.





Change area code

1. On the handset, touch  > PHONE SETUP > **SET AREA CODE**.
On the base unit, touch  > PHONE SETUP > PHONE UTILITIES > **SET AREA CODE**.
2. Touch .
3. Use **0-9** to enter your 3-digit area code.
4. Touch  to confirm.

Baby call

Baby call allows you to set a number to automatically dial when any key (apart from ) is touched.

To set Baby call:

1. On the handset, touch  > PHONE SETUP > **BABY CALL**.
On the base unit, touch  > PHONE SETUP > PHONE UTILITIES > **BABY CALL**.
2. Use  or  to select '**ON**'
3. Touch  to confirm.

FUNCTION SETTINGS

- Use **0-9** to enter the baby call number. Touch  on the handset or  on the base unit to delete numbers if an error is made.
- Touch  to confirm.





To de-activate baby call:

Repeat steps 1 to 3, selecting **OFF** instead of **ON**.

Auto answer – cordless handset only

Incoming calls are answered automatically when lifting the handset from the cradle when auto answer is activated.





To activate auto answer:

- Touch  > PHONE SETUP > **AUTO ANSWER**.
- Use  or  to select **ON**.
- Touch  to confirm.









SPECIAL FEATURES

Clock and alarm settings







To set the time:

- On the handset, touch  > SET TIME > **CLOCK SETTING**.
On the base unit, touch  > PHONE SETUP > TIME SETUP > **SET TIME & DATE**.
- Touch  .
- Use **0-9** to enter the time, (Use  to toggle AM / PM if 12 hour display format is selected).
Touch  to confirm.

To change time display format:

- On the handset, touch  > SET TIME > **DISPLAY FORMAT**.
On the base unit, touch  > PHONE SETUP > TIME SETUP > **TIME FORMAT**
- Touch  .
- Use  or  to select 12 / 24 hour format.
- Touch  to confirm.
- Use  or  to select month-day format 'MM/DD' or 'DD/MM'.
- Touch  to confirm.

To set the alarm:

- On the handset, touch  > SET TIME > ALARM > **ON**.
On the base unit, touch  > PHONE SETUP > TIME SETUP > ALARM > **ON**.
- Touch  .
- Use **0-9** to enter the alarm time. (use  to toggle AM / PM if 12 hour display format is selected).
- Touch  to confirm. The icon  shows to indicate that the alarm is set.

NOTE:

- If the alarm is activated during a call, you will hear 2 alarm tones and  will flash.

To de-activate the alarm:

Follow steps 1 and 2 above selecting **OFF** instead of **ON**.  will no longer be displayed.



SPECIAL FEATURES

To turn the alarm sound off:



Touch any key. If no key is touched, the alarm will ring for 1 minute and then automatically turn off.

Base-to-handset calling

To make an internal call in Standby mode from the base to the handset:

1. Touch  and the cursor will point to **INTERCOM**.
2. Touch  to enter the submenu option.
3. Touch  again to call the handset.

NOTE: To stop calling the handset, touch  on the base.

4. Cordless handset will ring. Press  to answer (twice for Speakerphone). If you turn AUTO ANSWER on, simply pick up the handset from the charger.
5. To end the call, touch  on the handset or  on the base.



NOTE: If the handset does not answer within two minutes, the operation is canceled .

To make an internal call in Standby mode from the handset to the base:



1. Touch  .
2. Touch '0' to call the base.



NOTE: To stop calling the base, touch  on the handset.

3. Base unit will ring. Pick up the corded phone or touch  for Speakerphone.

NOTE: If the base does not answer within two minutes, the operation is canceled. Internal calls are answered identically to external calls (see **BASIC FUNCTIONS**). If an external call is received during an internal call, you will hear a ringer tone from the receiver. Touch  to terminate the internal call and touch  on the handset or  on the base to answer the external call. Whichever phone answers the call will have Confidential Conversation privacy ie audio is cut off to the other phone in the combo system, unless the below action is taken...

To 3-way conference an ongoing call (ie “invite” the cordless handset to join):



1. In Talk mode, touch  to enter the submenu option.
2. Touch  to call the handset. If the handset does not answer the call within 2 minutes, will return to the external call automatically.



NOTE: To cancel the “invitation”, touch  or  on the base.

3. Cordless handset will ring. Touch  to answer (twice for Speakerphone).



To 3-way conference an ongoing call (ie “invite” the base to join):

1. In talk mode, touch  .
2. Touch '0' to call the base. If the base does not answer the call within 2 minutes, will return to the external call automatically.

NOTE: To cancel the “invitation”, touch  or  on the handset.

3. Base unit will ring. Pick up the corded phone or touch  for Speakerphone.
4. Touch  on the handset or put the phone back into the base cradle or touch  on the base to finish the conference call. The connection will remain between the remaining handset or base and the external line.







To transfer an ongoing call:

1. Repeat steps 1-3 above of the relevant 3-way conference section.
2. To transfer the call to the base, touch  on the handset. To transfer the call to the handset, put the phone back into the base cradle or touch  on the base.

SPECIAL FEATURES

Registration

The handset and base unit are factory pre-registered with each other. Therefore, the unit should be in full working order out of the box. If a problem occurs, follow this procedure:

1. On the handset, touch  > SECURITY SET > **REGISTRATION**.
2. Use  or  to select the base number you wish to register to.
3. Touch  to confirm.
4. Use **0-9** to enter the default PIN number **0000**.
5. Touch  to confirm. Press and hold **PAGE** at the base until the line LED flashes and 'REGISTERING...' appears on the base screen.
6. Wait for handset to register with the base unit.
7. **REGISTRATION ACCEPTED** indicates that handset is registered. **RETRY?** indicates that registration has failed. Touch  to retry or  to quit.

DIGITAL ANSWERING SYSTEM

The digital answering system includes standard messaging functions such as:

- Up to 13 minutes recording time and up to 50 messages.
- Recording, playback and delete functions for received messages.
- Recording of memo notes.
- Remote access code function.
- Ring delay to answer selection with time saver functions.
- Selectable multi-language prompts (English and French).
- Record messages with timestamp

DIGITAL ANSWERING SYSTEM

Menu options

To view the Answer System menu options:

On the base, Touch  > **ANSWER MACHINE** menu option.

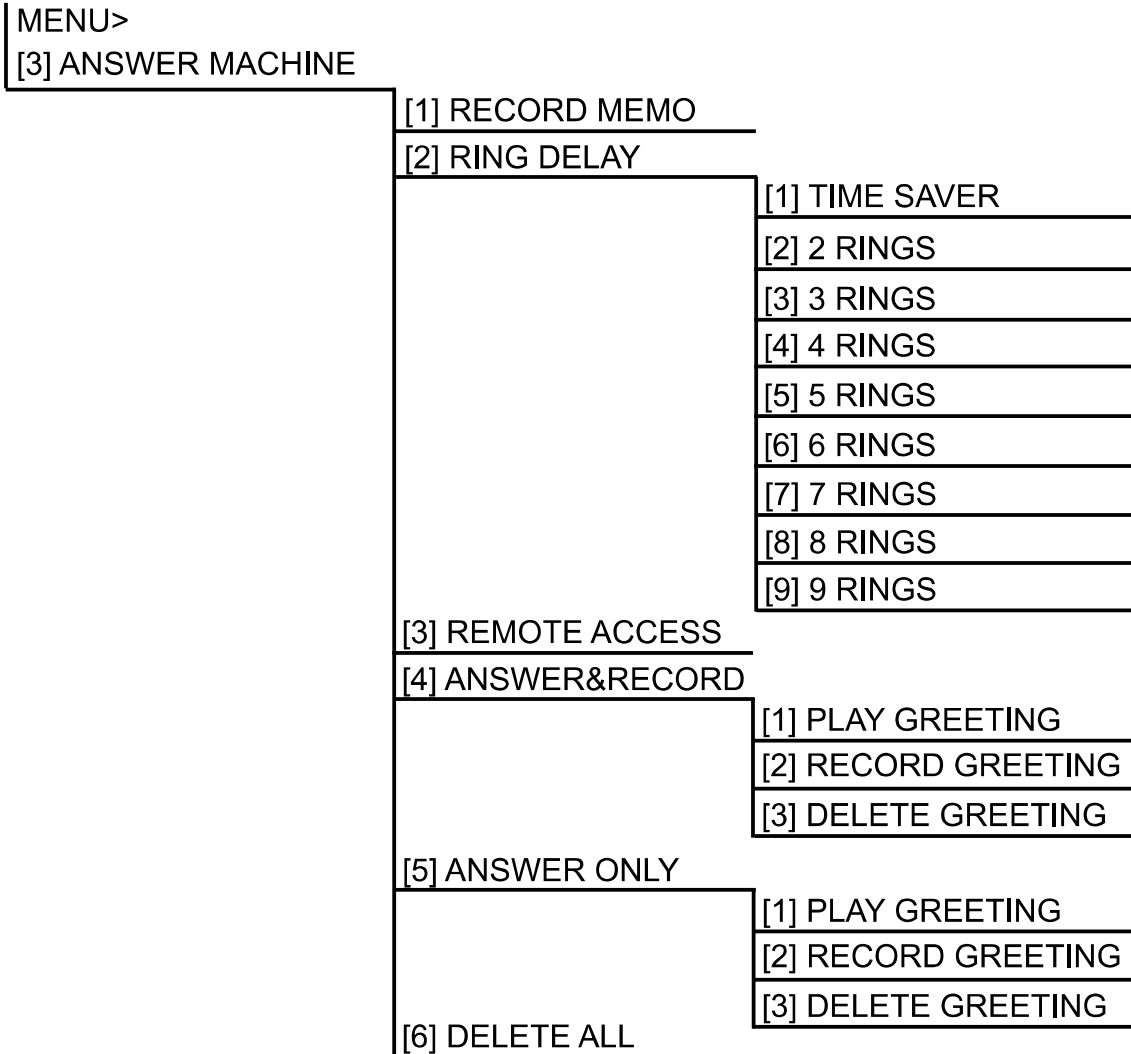

ANSWERING SYSTEM FUNCTIONS--BASE UNIT ONLY

To turn the answering system on/off:

Touch  repeatedly to select one of the following options:

- **ANSWER ON:** Switches the answering system **ON**. The LCD displays **ANSWER & RECORD**.
- **ANSWER ONLY:** Switches the answering system to "Announce Mode". The LCD displays **ANSWER ONLY**.
- **ANSWER OFF:** Switches the answering system **OFF**. The LCD displays **ANSWER OFF**. The ANSWER SYSTEM LED will off.



When new messages have been received,  shows and the ANSWER SYSTEM LED will flash.

NOTE:





- The unit automatically returns to standby mode when no input is made.
- If there are any new messages in the mailbox, the number of messages will be displayed.

ANSWERING SYSTEM FUNCTIONS--BASE UNIT ONLY

To adjust the volume level:

During announcements or message playback, touch  or  to increase or decrease the volume. The selected volume level **VOL0** to **VOL5** will show.

To playback messages from the mailbox:

1. In standby mode and with the handset on the base unit, touch . If a new message is present, **PLAY NEW MESSAGE** shows. Otherwise **PLAY OLD MESSAGE** shows.
2. During the message playback,
 - Touch  twice within 1 second to play the previous message.
 - Touch  once to play next message.
 - To repeat the current message, touch  once.

To stop during the playback:

During a message playback, touch  to stop and exit playback mode.





NOTE:

- The number of old or new messages will be announced prior to playing the message. Each message number, date / time recorded will also be announced. New messages will be played first.
- When all new messages have been played, The END OF NEW MESSAGES announcement will play. The icon  will disappear and the ANSWER SYSTEM LED will stop flashing.
- When all messages have been played, the announcement END OF MESSAGES will play.
- The answering system uses the time to timestamp the recorded messages.

To delete a message:



1. During a message playback, touch . The next message will be played.

To delete all old messages in the mailbox:

1. In standby mode and with the handset on the base unit.
2. Touch  > ANSWER MACHINE > **DELETE ALL**.
3. Touch  to select option. The message **DELETE ALL** shows.
4. Use  or  to select **YES**.
5. Touch  to confirm.

NOTE: New messages cannot be deleted unless they have been played.

To record a memo note:

1. Touch  > ANSWER MACHINE > **RECORD MEMO**.
2. Touch . The memo recording announcement will play and a start recording beep will sound. After the beep, start recording your memo. **MEMO RECORDING** and the recording time is shown. The maximum recording time of each memo is 1 minute.
3. To end the recording, touch .

NOTE: The recording will stop automatically if the memory is full.

Announcements



There are two types of announcements:

- One for normal call – the answering system will play the announcement message and then the caller can leave its message.

ANSWERING SYSTEM FUNCTIONS--BASE UNIT ONLY

- One for announcement only – the answering system will play the announcement message and the caller cannot leave a message. (The answering system must be set to the **ANSWER ONLY** setting.)

To record a personalized announcement:



1. Navigate to ANSWER & RECORD or ANSWER ONLY > **RECORD GREETING**.
2. Touch . The message **GREETING RECORDING** shows and a start recording beep will sound to indicate that the recording is starting.
3. Record the desired announcement. The recording time **00:00** (in seconds) will show. The maximum recording time of a personalized announcement is 1 minute.
4. Touch  to stop recording. The system will play the recorded announcement automatically.

NOTE: When memory is full:

- No personalized announcement can be recorded.
- The announcement recording stop automatically.

NOTE: When the answering system is set to OFF, your answering system will answer calls after 20 rings. The system will announce 'I'm not available now and you cannot leave a message, so please call later'.

To play an announcement:

1. Navigate to ANSWER & RECORD or ANSWER ONLY > **PLAY GREETING**.
2. Touch . The message **GREETING PLAYING** shows and the recorded announcement plays.
3. Touch  to stop.

To delete an announcement:

1. During announcement playback, touch . The system will play 'CUSTOMER OUTGOING MESSAGE DELETED' followed by the default announcement. The default announcement will be used.

Or





1. Navigate to ANSWER & RECORD or ANSWER ONLY > **DELETE GREETING**.
2. Touch  to confirm.

NOTE: The default announcement cannot be deleted from the system's permanent memory.



Ring delay

The ring delay function allows you to set the number of rings before the system answers an external call.

To set the ring delay:

1. Navigate to ANSWER MACHINE > **RING DELAY**.
2. Touch .
3. Use  or  to select **TIME SAVER, 2, 3, 4, 5, 6, 7, 8 or 9 RINGS**.
4. Touch  to confirm.

Screen calls



When there is incoming call, you may let the answering system answer the call and listen to the recording of the incoming message (it will broadcast from the base speaker). Then decide whether you want to take the call. Touch  on the handset or  on the base if you want to take the call.

ANSWERING SYSTEM FUNCTIONS--BASE UNIT ONLY

Remote access to the answering system

You can remotely check your messages from any external line. It is advisable for security reasons that you set up a personalized 4-digit remote access code before you remotely access the mailbox.

To set up the remote access code:

1. Navigate to ANSWER MACHINE > **REMOTE ACCESS**.
2. Touch . The message **REMOTE ACCESS** and the default code **0000** will show.
3. Enter the new 4-digit code using the keypad **0-9**.
4. Touch  to confirm.

To remotely access the answering system:

1. Call the answering system using a tone dialing telephone and wait for the answering system outgoing announcement.
2. Press  during outgoing message playback, the system will play 'Please enter your remote access code'
3. Enter the remote access 4-digit code. If correct, the 'REMOTE ACCESS CODE ACCEPTED' announcement will play and then the commands for remotely accessing the mailbox will be announced (see table below). If incorrect, the 'REMOTE ACCESS CODE ERROR' announcement will play, re-enter the correct remote access code.

FUNCTION	COMMAND
Play mailbox messages	Press 1 to start playing messages
Play previous message	During message playback, press 4 twice within 1 second
Replay message	During message playback, press 4
Stop message	During message playback or recording, press 5 to stop
Play next message	During message playback, press 6
Delete current message	During message playback, press 7
Record memo	During remote access standby, press 8 to record memo
Record announcement	Press 9 to record announcement. After recording, the announcement is played back
Toggle answering system on, off or "answer only" mode	During remote access standby, press 0
Play the help function on remote access commands	During remote access standby, Press *
When you have finished using the remote answer system, end the call to return to standby mode	Timeout





ANSWERING SYSTEM FUNCTIONS--BASE UNIT ONLY

Memory full

Your answering system can record up to 13 minutes message, when the recording memory is full or the number of messages reached 50, the LCD will show MEMORY FULL and the icon  will flash. In this case, no new message will be accepted. The system will only answer calls after 10 rings and announce MEMORY IS FULL. Erase some or all messages in the memory to make room.

RESET

To reset the touch phone default settings:

1. Touch  and select **SET DEFAULT**.
2. Use  or  to select **YES**.
3. Touch  to confirm.

NOTE: All the settings you have made will be restored to the default factory settings if you reset.

DEFAULT SETTINGS

PARAMETERS--PHONES	DEFAULT VALUE
Language	English
Internal & external ring volume	3
External ring pattern	Ring tone 3
Internal ring pattern	Tone 1
Alarm	Off
Alarm time	12:00AM
Display format	12-hour
Month-date display format	MM / DD
Key click tone	Pattern 2
Baby call	Off
Baby call number	Clear
Dial mode	Tone Dial
Flash time	600 ms
Backlight time	20s
Handset name	Clear
LCD contrast level	5 (base), 10 (handset)
Handset volume	Vol. 1
Speaker phone volume	Vol. 3
Area code	Clear
PARAMETERS --ANSWERING SYSTEM	DEFAULT VALUE
Answer mode	ANSWER AND RECORD
Ring delay	5
Remote access code programming	0000
Speaker phone volume	3
Pre-recorded announcement	Clear

ADDING MORE CORDLESS TOUCH HANDSETS

The following models are available:

CLTD6620 (black), CLTD6620WH (white) - single handset

CLTD6622 (black), CLTD6622WH (white) – 2 handsets

They have the same appearance and operate in a mostly similar manner to the cordless Touch handset included in the Combo system. If only 1 phone line jack is available in the entire dwelling, their base can share the same phone line jack as the Combo by obtaining a widely-available inexpensive adapter that derives 2 jacks from 1.

Please visit Sanyo.ca to view the above Touch models and participating retailers.

NOTE: Because of the security features built into the Touch Combo system, Confidential Conversation and internal calling/intercom functions will not extend to the additional handsets.

TROUBLESHOOTING

See below for some common problems and their remedies. Whatever the problem, you should first check that:

- The base unit is connected to the power supply and phone line.
- The main power is switched on at the socket.
- The handset battery pack is installed and has not run out of power.

DO NOT attempt any repairs yourself which will invalidate your warranty.

PROBLEM	POSSIBLE CAUSES/REMEDIES
Can't make a call / OUT OF RANGE appears on the handset	<ul style="list-style-type: none"> • Out of range to base unit – move closer • De-synchronization has occurred. The base unit will reset synchronization automatically • Handset may not still be registered to base unit, see SPECIAL FEATURES – Registration
Can't enter the submenus	<ul style="list-style-type: none"> • Ensure unit is not in cradle • Return to Standby mode by touching end
Every button I touch calls a preset number	<ul style="list-style-type: none"> • Phone is in Baby Call mode. To deactivate see FUNCTION SETTINGS – Baby Call
Caller ID is not displayed	<ul style="list-style-type: none"> • Check your network subscription to Caller ID • Full name and number (incl. STD code) need to be stored in phonebook for name display
Handset and the base unit do not ring	<ul style="list-style-type: none"> • Ring Volume is OFF, see FUNCTION SETTINGS – Change Ring and Key Tones
When I'm talking on the cordless phone I keep activating other keys	<ul style="list-style-type: none"> • Make sure that your ear is touching the top section of the handset (receiver) when you are talking
Mute, intercom, speakerphone don't work during calls	<ul style="list-style-type: none"> • Check if Manual Key Lock or Smart Key Lock is engaged. see FUNCTION SETTINGS - Smart key lock and Manual key lock
Battery pack is low, even if recharged	<ul style="list-style-type: none"> • Battery pack may need to be replaced. Best to purchase new 1 or 2 in advance (see separate order form)
I can't make an internal call	<ul style="list-style-type: none"> • Only one external call and one internal call can take place at once. Make sure the handset or the base is making a call

CHANGING THE BATTERY--CORDLESS HANDSET ONLY

Battery replacement and handling

When the operating time becomes short even after a battery is recharged, please replace the battery.

With normal usage, your battery should last approximately one year.

For a replacement battery, please contact your place of purchase or fill out and mail the enclosed form.

CAUTION:

- Use only the specified battery pack type (Ni-MH 3.6V, 650mAh).
- Do not remove the battery from the handset to charge it.
- Never throw the battery into a fire, disassemble it, or heat it.
- Do not remove or damage the battery casing.
- Remove battery if storing the phone for over 30 days.

Make sure the telephone is off before you replace the battery

1. Slide off the battery compartment cover.
2. Remove the battery pack from the compartment.
3. Insert the new battery pack according to the polarity engraved.
4. Put the battery compartment cover back on.
5. Place handset on the charger to charge for 15 hours.

Charge the handset battery for 15 continuous hours prior to first use. The initial battery charge is important for best performance.

CAUTION: To reduce the risk of fire or personal injury, use a NI-MH 3.6 V, 650mAh battery.

Replacement part number: **3SN-AAA**

POWER FAILURE

When power is off, if you installed 3 AA size alkaline batteries (not included) in base as a power backup, you will still be able to make or receive calls with the telephone. If not, you will not be able to make or receive calls with the telephone.

RECYCLING NICKEL--METAL HYDRIDE BATTERIES

NICKEL-METAL HYDRIDE BATTERIES MUST BE DISPOSED OF PROPERLY.

Please take your used battery pack to a store that recycles Ni-MH batteries. Call 1-800-822-8837 or go to www.rbrc.ca



HEADSET JACK

Headset connection (Headset not included) For hands free conversation, connect the headset (not included) to the **HEADSET** jack. The handset earpiece and microphone are disabled when the headset is connected. Touch  to answer or place a call while using the headset.

For purchasing, servicing or replacement, please contact our service center.

SANYO Canada Inc.

1-300 Applewood Cres.

Concord, Ont. L4K 5C7

(905) 760-9944

1-800-263-2244

www.sanyo.ca

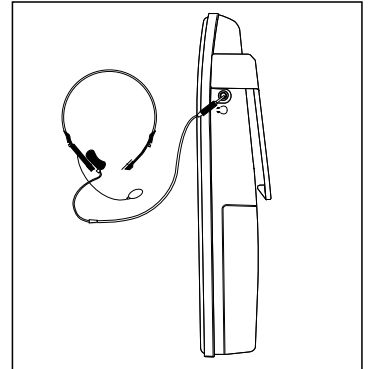

MAINTENANCE

To keep your telephone working and looking good, follow these guidelines:

- Avoid putting the phone near heating appliances and devices that generate electrical noise (for example, motors or fluorescent lamps).
- Do not expose to direct sunlight or moisture.
- Avoid dropping the phone, and other rough treatment to the phone.
- Clean the phone with a soft cloth.
- Never use a strong cleaning agent or abrasive powder because this will damage the finish.
- Periodically clean the charge contacts on the handset and charger with a clean pencil eraser.
- Retain the original packaging and your original sales receipt in case you need to ship the phone at a later date.

MAXIMIZE BATTERY PERFORMANCE

The freedom that your cordless telephone can offer is fully dependent on the performance of the rechargeable battery in the handset. To maximize the battery performance, follow these guidelines:

Charge it for a full 15 hours

Before initial use of your new battery, charge it for 15 hours continuously. The proper initial charging is very important to maximize the battery performance.

Keep the contacts clean

You can never fully recharge the battery if the contacts are dirty. Clean all the contacts – two at the bottom of the handset and two in the charger - periodically. Use a clean pencil eraser or superfine steel wool to clean the charging contacts. Avoid touching the cabinet area of the phone, or scratches may occur.

Refresh battery

If your battery seems to need recharging more often than usual, it may have lost part of its charging capacity. To bring back its full capacity, try “refreshing” the battery:

1. First discharge the battery by leaving the handset in TALK mode until Battery Low indication turns on. (Disconnect the base from the telephone line, so that your line is not busy all the time.)
2. Then charge it for 15 continuous hours.
3. Repeat the above once more. As your phone use a Ni-MH battery you are free to leave your handset in the charger for as long as you like, without affecting the performance of the battery life.

SPECIFICATIONS

The corded base unit

TYPE	DESCRIPTION
Dimension	196(L)X152(W)X67(H)/mm
Weight	541g
Standard	Digital Enhanced Cordless Telecommunications 6.0 (DECT 6.0)
Frequency range	1.9 GHz
Channel bandwidth	1.728 MHz
Modulation	GFSK
Base power supply	Main supply: 120V / 60Hz, 8VDC, 500mA
	Battery back up: 3 x AA alkaline
Operating time (back up battery mode)	Standby: Approximately 12 hours
	Talk time: Approximately 5 hours
Operating temperature	0°C to 40°C (32°F to 113°F)
Storage temperature	-20°C to 60°C (-4°F 140°F)

The cordless handset

TYPE	DESCRIPTION
Handset	141 x 44 x 24 mm (5.55 x 1.73 x 0.94 in)
Handset weight	125 g (4.41 oz)
Charger	91 x 80 x 45 mm
Charger weight	75g
Transmission platform	Digital Enhanced Cordless Telecommunications 6.0 (DECT 6.0)
Frequency range	1.9 GHz
Channel bandwidth	1.728 MHz
Modulation	GFSK
Charger power supply	120V / 60Hz, 6VDC, 300mA
Rechargeable battery	NiMH 650mAh 3.6V (AAA) battery pack
Cordless operating time (new battery)	Standby: Approximately 120 hours
	Talk: Approximately 5 hours
Operating temperature	0°C to 45°C (32°F to 113°F)
Storage temperature	-20°C to 60°C (-4°F 140°F)

TECHNICAL INFORMATION

REN Number:

The Ringer Equivalence Number (REN) assigned to each terminal's device provides an indication of the maximum number of terminals allowed to be connected to a telephone interface.

The REN number of this phone is located on the bottom of the base unit. The termination on an interface may consist of any combination of device subject only to the requirement that the sum of the Ringer Equivalence Numbers of all the devices does not exceed 5.

CAUTION

This product is intended for use in the CANADA only. Sale or use in other countries may violate local laws.

Cordless telephones use radio frequencies to allow mobility. This affects the performance of your phone.

To maintain compliance with the FCC's RF exposure guidelines it is recommended a typical distance at least 20cm is maintained between the base unit and nearby persons.

1. NOISE

Electrical pulse noise is present in most homes at one time or another. This is most intense during electrical storms.

Certain kinds of electrical equipment, such as light dimmers, fluorescent bulbs, motors, fans, etc., also generate pulse noise.

Because radio frequencies are susceptible to this, you may on occasion hear pulse noise through the handset. This is usually only a minor annoyance and should not be interpreted as a defect of the phone.

2. RANGE

Because radio frequencies are used, the location of the base station can affect the operating range of the phone. Try several locations and choose the one that gives the clearest signal to the handset. Generally, a central area on the highest floor in a multi-floor residence yields best results.

3. INTERFERENCE

Electronic circuits activate a relay to connect

the unit to your telephone line. These electronic circuits operate in the radio frequency spectrum. While several protection circuits are used to prevent unwanted signals, there may be periods when these unwanted signals enter the base station. You may hear a click or hear the relay activate when you are not using the cordless handset. If this occurs frequently, or relocating the base station.

4. RADIO EQUIPMENT

The term "IC:" before the radio certification number only signifies that Industry Canada technical specifications were met. Operation is subject to the following two conditions (as set by Industry Canada): (1) this device may not cause harmful interference, and (2) this device must accept any interference, including interference that may cause undesired operation of the device.

NOTICE:

Cordless telephones are radio devices. Communications between the handset and base of your cord-less telephone are accomplished by means of radio waves which are broadcast over the open airways. Because of the inherent physical properties of radio waves, your communications can be received by radio receiving devices other than your own cordless telephone unit. Consequently, privacy of communications may not be ensured when using this phone.

The Industry Canada Label identifies certified equipment. This certification means that the equipment meets certain telecommunications network protective, operational and safety requirements. The ministry does not guarantee that the equipment will operate to the user's satisfaction.

TECHNICAL INFORMATION

Before installing this equipment, users should ensure that it is permissible to be connected to the facilities of the local telecommunications company. The equipment must also be installed using an acceptable method of construction. In some cases, the company's inside wiring associated with single-line individual service may be extended by means of a certified connector assembly (telephone extension cord). The customer should be aware that compliance with the above conditions may not prevent degradation of service in some situations.

Repairs to certified equipment should be made by an authorized Canadian maintenance facility designated by the supplier. Any repairs or alterations made by the user to this equipment, or equipment malfunctions, may give the telecommunications company cause to request that the user disconnect the equipment.

The user should ensure for his own protection that the electrical ground connections of the power utility, telephone lines and internal metallic water pipe system, if present, are connected together. This precaution may be particularly important in rural areas.

CAUTION

Users should not attempt to make such connections themselves, but should contact the

appropriate electrical inspection authority, or electrician, as appropriate. The exclamation point within an equilateral triangle is intended to alert the user to the presence of important operating and maintenance (servicing) instructions in the literature accompanying the product.

This symbol on the product is used to identify the following important information. Use only with specified SANYO power adaptor.

NOTICE: This product meets the applicable Industry Canada technical specifications. This is confirmed by the registration number. The abbreviation, IC, before registration number signifies that registration was performed based on a Declaration of Conformity indicating that Industry Canada technical specifications were met. It does not imply that Industry Canada approved the equipment.

This Class B digital apparatus complies with Canadian ICES-003.

SANYO COMFORT WARRANTY

WARRANTY APPLICATION

SANYO Communications products purchased new, unused in Canada through a SANYO Authorized Dealer are warranted against manufacturing defects in materials and workmanship for ONE YEAR covering parts and labor, from the date of purchase by the original retail purchaser. This warranty only applies in favor of the original retail purchaser of the warranted product.

SANYO CANADA INC.'S RESPONSIBILITY

During the warranty period, SANYO Canada Inc. will repair, or at our option, replace a Communications product which shows evidence of a manufacturing defect in materials or workmanship. Replacement PARTS are warranted for the remaining portion of the warranty period.

WHAT IS NOT COVERED

- a. Communications products purchased outside Canada.
- b. Communications products purchased in a used condition.
- c. Communications products purchased from non SANYO authorized dealer.

SANYO COMFORT WARRANTY

- d. Communications products not intended for Canadian usage or products without appropriate Canadian regulatory approvals.
- e. Problem due to product set-up and installation.
- f. Adjustments that are outlined in the Operating Manual.
- g. Accessory items including antenna and batteries.
- h. Damage in or due to transportation.
- i. Damage due to improper maintenance, accident, abuse, misuse or negligence.
- j. Damage caused by lightning and power surges.

ORIGINAL RETAIL PURCHASER'S RESPONSIBILITY

You, the original retail purchaser, must present your original, dated bill-of-sale together with this warranty to SANYO Canada Inc. or to an authorized SANYO Service Depot when you make a claim under this warranty.

You, the original retail purchaser, are responsible for any costs of TRANSPORTING the product to and from SANYO Canada Inc. or an authorized SANYO Service Depot.

You also are responsible for the cost of any MAINTENANCE necessary in respect of the product.

WARRANTY BECOMES VOID

This warranty becomes void if the product's serial numbers are altered or removed or if any repair to the product is made other than by SANYO Canada Inc. or by an authorized SANYO Service Depot.

LIMITATIONS

- a. SANYO Canada Inc. reserves the right to change or improve the design of the model of the product warranted hereunder without incurring any obligation to make any modifications to or to install any improvement in or on the product.
- b. In no event shall SANYO Canada Inc. or any of its Authorized Dealers be liable for special or consequential damage arising from the use of this product.

STATUTORY WARRANTIES

The above provisions do not preclude the operation of any applicable provincial statute which in certain circumstances may not allow some of the limitations and exclusions described in this warranty.

Where any terms of this warranty are prohibited by such a statute, they shall be deemed null and void but the remainder of this warranty shall remain in effect.

HOW TO OBTAIN WARRANTY SERVICE

Please contact the SANYO Authorized Dealer from whom the product was purchased, or contact us directly at:

SANYO Canada Inc.
1-300 Applewood Cres.
Concord, Ont. L4K 5C7
(905) 760-9944
1-800-263-2244

SOS HELP LINE

At SANYO, fulfilling the needs of our customers is a priority. That's why we created our SOS customer service program that guarantees satisfaction.

NATIONWIDE CUSTOMER SUPPORT

SOS is there to help you. Our friendly and knowledgeable product specialists will quickly answer your questions about setup and use of SANYO telephone products. Simply call toll free from anywhere in Canada to connect to our no-charge, SOS support and service network:

1-800-263-2244

Or visit our website at www.sanyoservice.com, and click the **Customer Relations** button to get access to our FAQ's (Frequently Asked Questions) and other helpful features.

STAY-AT-HOME CONVENIENCE

It's a nuisance making another trip to the store when you're stuck. Now with SOS, all that's necessary is a quick call for your home for product assistance.

HASSLE-FREE EXCHANGE

Should your SANYO telephone require servicing due to a manufacturing defect during the warranty period. SANYO Canada will ship prepaid a replacement unit* within two business days after receiving your defective unit. **Consumers are responsible for the shipping costs of the unit back to SANYO.**

For older, non-current models, replacement units may not be available, in which case our regular warranty conditions will apply.

GUARANTEED QUALITY

All SOS replacement sets are checked and serviced by factory-authorized technicians before being sent out.

SOS means you never have to worry.

C.O.D. and/or Collect shipments will not be accepted.

Unit must be returned to SANYO in its original box with all accessories, i.e.: owner's manual, battery, adaptor, telephone cord, etc.



CODE NO.:086L005460-013

SANYO Electric Co.,Ltd.
Printed in China

Free Manuals Download Website

<http://myh66.com>

<http://usermanuals.us>

<http://www.somanuals.com>

<http://www.4manuals.cc>

<http://www.manual-lib.com>

<http://www.404manual.com>

<http://www.luxmanual.com>

<http://aubethermostatmanual.com>

Golf course search by state

<http://golfingnear.com>

Email search by domain

<http://emailbydomain.com>

Auto manuals search

<http://auto.somanuals.com>

TV manuals search

<http://tv.somanuals.com>