

SANYO

INSTRUCTION MANUAL

CLT-2430

2.4-GHz
Digital Spread Spectrum
Cordless Telephone
with Call Manager Features

CM
CALL MANAGER

2.4 GHz
DSS DIGITAL
SPREAD SPECTRUM

IMPORTANT

Charge the handset battery pack for a full 15 hours before using your cordless handset for the first time.

www.sanyocanada.com

Introduction

Congratulations on your purchase of the CLT-2430 cordless telephone.

This phone is designed for reliability, long life, and outstanding performance utilizing the latest in 2.4-GHz Digital Spread Spectrum technology.

Note: Some illustrations in this manual may differ from the actual unit for explanation purposes.

Features

- 2.4-GHz Digital Spread Spectrum Technology
- Dual Keypad
- Call Manager Features*: Caller ID, Caller ID on Call Waiting and Call Waiting with Options
*Each feature works with your network service. A subscription required.
- 50-Number Caller ID List
- Programmable Network Service Key
- Voice Message Waiting Indicator (on Base)
- 3-Line, 16-Character Backlit Handset Display
- Lighted Handset Keypad and TALK/END Key
- 20-Name/Number Directory on the Handset
- 10-Number Speed Dial on the Base
- Last 3-Number Redial
- HandsFree Speakerphone in the Handset
- 7-Day Standby Battery Life/6-Hour Talk Time
- 30-Channel Auto/Manual Scan
- Call Time Display
- Pulse/Tone Dialing
- Intercom/Page/Handset Locator
- Handset Earpiece, Speaker and Ringer Volume Controls
- Belt Clip and Headset Jack
- Wall-Mountable
- Hearing Aid Compatible

2.4-GHz Digital Spread Spectrum Technology utilizes a "wider frequency band" vs. a "single narrow band" used in standard digital transmissions. The result is the clarity of digital sound, extended range and a secure conversation with virtually no interference from other 2.4-GHz cordless phones or radio transmission devices.

The clearest channel is automatically selected for each transmission. The phone selects one of over 65,000 digital security codes for the handset and base.

These features enhance your phone's security and also prevent unauthorized calls as a result of your phone being activated by other equipment.

Controls and functions

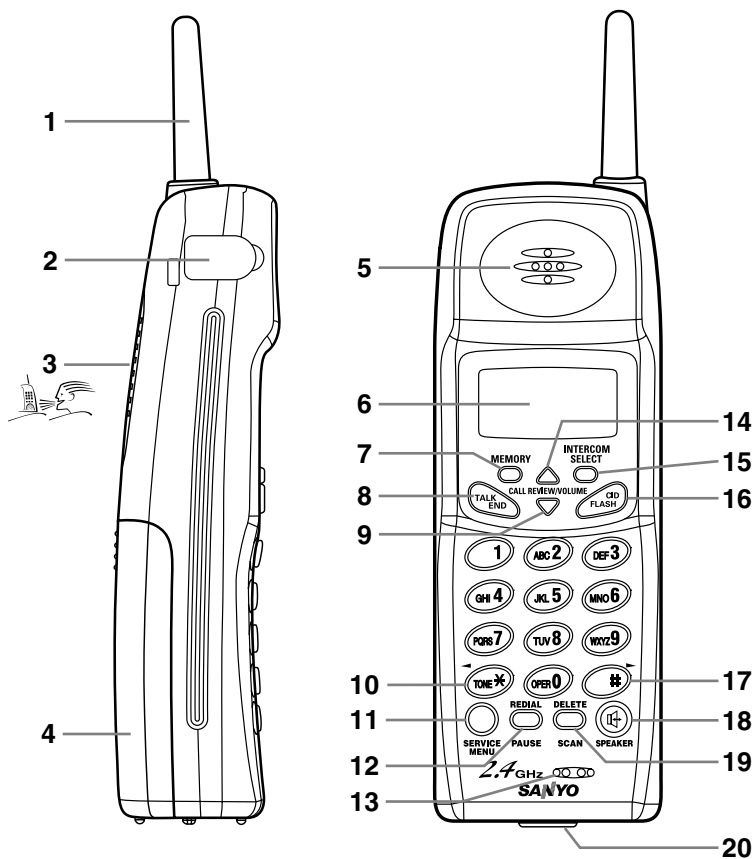

- | | |
|-------------------------------------|---------------------------------|
| 1. Handset antenna | 12. REDIAL/PAUSE key |
| 2. Headset jack cover | 13. Microphone |
| 3. HandsFree speaker | 14. CALL REVIEW/VOLUME (up) key |
| 4. Battery compartment | 15. INTERCOM/SELECT key |
| 5. Earpiece speaker | 16. CID/FLASH key |
| 6. LCD display | 17. Right cursor key (#/▶) |
| 7. MEMORY key | 18. SPEAKER key |
| 8. TALK/END key | 19. DELETE/SCAN key |
| 9. CALL REVIEW/VOLUME (down) key | 20. Handset charging contacts |
| 10. Left cursor key (TONE/ * / ◀) | |
| 11. SERVICE MENU key | |

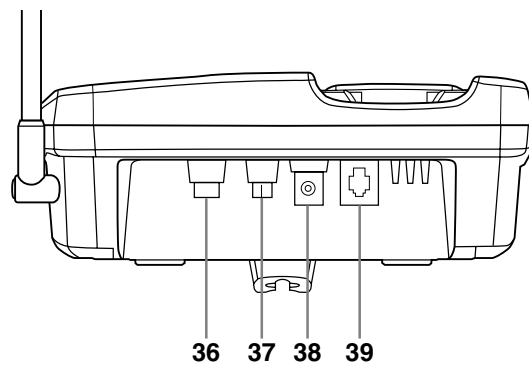
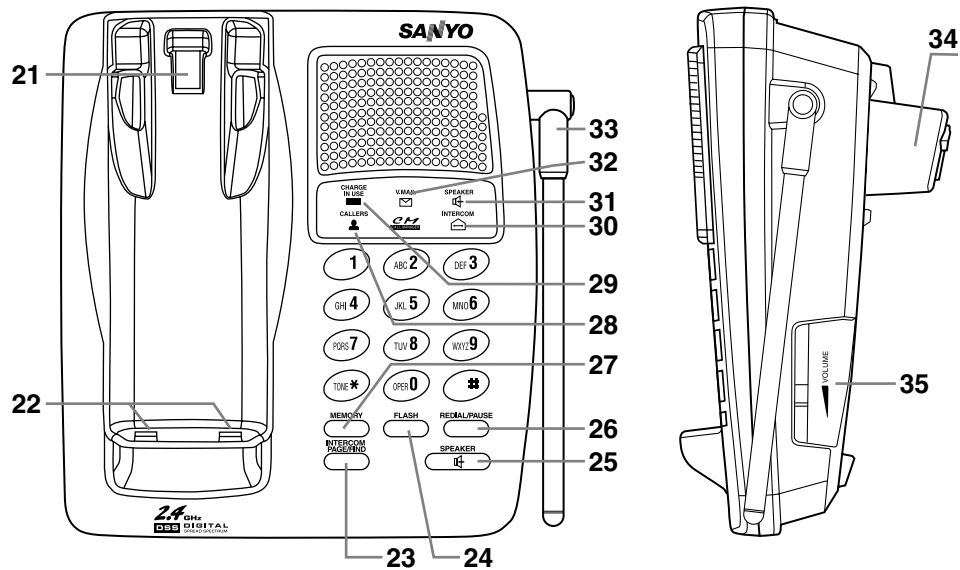

- 21. Handset retainer
- 22. Base charging contacts
- 23. INTERCOM/PAGE/FIND key
- 24. FLASH key
- 25. SPEAKER key
- 26. REDIAL/PAUSE key
- 27. MEMORY key
- 28. CALLERS indicator
- 29. CHARGE/IN USE indicator
- 30. INTERCOM indicator
- 31. SPEAKER indicator
- 32. VOICE MAIL indicator
- 33. Base antenna
- 34. Bottom bracket
- 35. VOLUME control
- 36. Ringer Volume switch
- 37. Pulse-Tone switch
- 38. DC power input
- 39. TEL LINE jack

CONTENTS

Introduction/Features.....	inside front cover
Controls and Functions.....	inside front cover
Getting started	
Read this first.....	E2
Step 1: Checking the package contents.....	E3
Step 2: Setting up the base unit	E4
Desktop use.....	E5
Mounting the base unit on a wall	E7
Step 3: Preparing the battery pack	E9
Basics	
Making a call	E11
HandsFree Speakerphone in the Handset.....	E12
Receiving a call.....	E14
Call Waiting	E15
Lighted keypad.....	E16
Scanning	E16
Adjusting the ringer and earpiece volume.....	E16
Redialing a call.....	E17
Directory/speed-dial	
Using the handset directory.....	E19
Using the base station speed-dial memory	E26
Caller ID features	
Caller ID	E28
When the telephone rings.....	E30
Viewing the Caller ID list.....	E31
Deleting information from the Caller ID list.....	E32
Using the Caller ID list	E34
Using Caller ID on Call Waiting service.....	E36
Advanced calling features	
List of features	E37
Voice mail access	E38
Call transfer feature.....	E40
Intercom feature.....	E41
3-way conference feature	E42
Accessing calling features	E43
Pre-programmed calling features.....	E44
Adding new features	E45
Call Waiting with Options.....	E47
Additional Information	
Changing the digital security code	E48
Installing the belt clip.....	E49
Headset installation	E49
Note on power source.....	E50
Maintenance	E50
Troubleshooting.....	E51
Technical Information	E52
Warranty	E53
Sanyo-On-Site (SOS) Information	E54

Getting Started

Basics

Directory/
speed-dial

Caller ID
Features

Advanced Calling
Features

Additional
Information

E1

GETTING STARTED

Read this first

This cordless telephone must be set up before use. Follow these steps:

Step 1 (page E3)

Unpack and check the telephone and accessories.

Step 2 (page E4 to E8)

Choose the best location to set up the base unit.

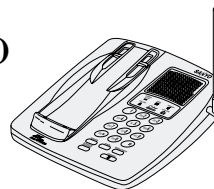

Base unit

Step 3 (page E9 to E10)

Insert the battery pack into the handset. You must charge the battery pack for a full 15 hours before using the phone.



Handset

About the digital security code

This cordless telephone uses a digital security code to prevent unauthorized access to your base unit. This security code prevents other cordless handsets from making calls through your base unit.

A random security code will be assigned automatically between your base unit and handset when you charge the battery pack for the first time.

If you want to reset the security code, see page E48.

GETTING STARTED

Checking the package contents

Make sure you have received the following items in the package.

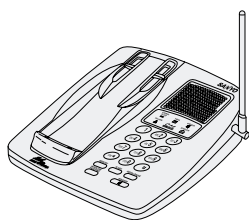

• Base unit



• Handset

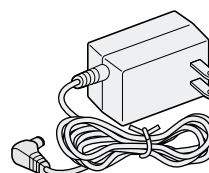

• AC adaptor
(AD-350)

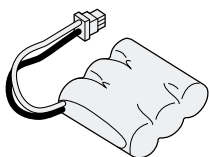

• Rechargeable
battery pack
(SANYO 3KR-600AAL)

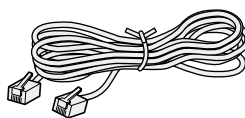

• Telephone line
cord (1)

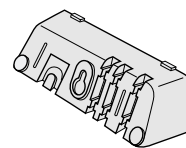

• Bottom bracket
for desktop use
and wall-mounting

• This Owner's Manual

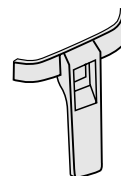

• Belt clip

GETTING STARTED

Setting up the base unit

Avoid places near electrical equipment such as refrigerators, computers, TVs, microwaves or fluorescent lamps. These may cause interference or reduce the operating range of the cordless telephone.

Do the following steps:

- Choose the best location
- Connect the base unit
- Choose the dialing mode

Notes:

- The location should be close to both a phone jack and a continuous power outlet which is not switchable.
- Be sure there is sufficient space to raise the base antenna fully to a vertical position.
- The base can be placed on a desk, tabletop or mounted on a standard wall plate.

GETTING STARTED

Desktop use

Connect the base unit

If you want to install the base unit on the wall, see page E7.

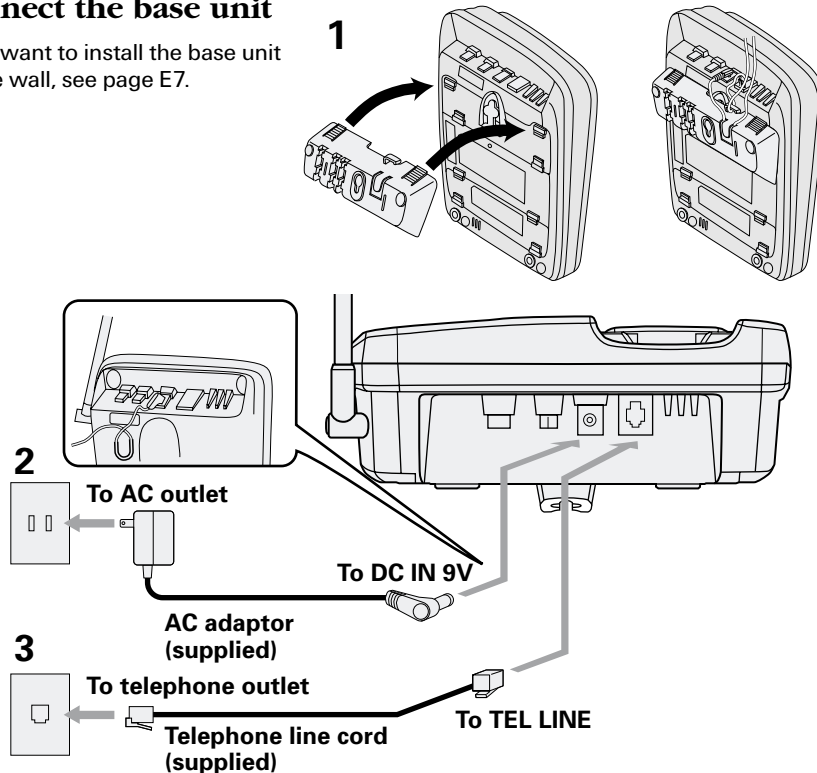

Note:

When connecting the power cord, make sure it does not create a trip or fire/electrical hazard. Avoid places where it could become chafed.

- 1** Snap the bottom bracket into the notches on the base.
- 2** Connect the AC adaptor to the **DC IN 9V** jack and to a standard 120-V AC wall outlet. Then raise the antenna to a vertical position.
- 3** Connect the telephone line cord to the **TEL LINE** jack and to a telephone outlet.

Note:

To assure proper handset charging, the bottom bracket must be attached.

GETTING STARTED

Notes:

- Use only the supplied AD-350 AC adaptor. Do not use any other AC adaptor.
- Connect the AC adaptor to a continuous power supply.
- Place the base unit close to the AC outlet so that you can unplug the AC adaptor easily.
- If your telephone outlet is not modular, contact your telephone company for assistance.

Choose the dialing mode

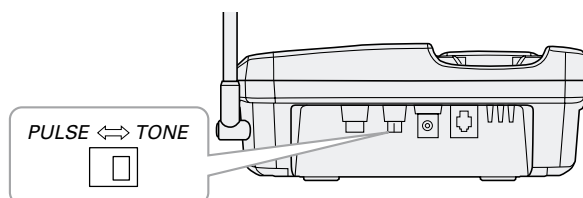

Depending on your dialing system, set the **PULSE-TONE** switch as follows:

If your dialing system is	Set the switch to
Tone	TONE
Pulse	PULSE

If you are not sure of your dialing system

Make a trial call with the **PULSE-TONE** switch set to **TONE**.
If the call connects, leave the switch as is; otherwise, set to **PULSE**.

GETTING STARTED

Mounting the base unit on a wall

Standard wall plate mounting

This phone can be mounted on any standard telephone wall plate.

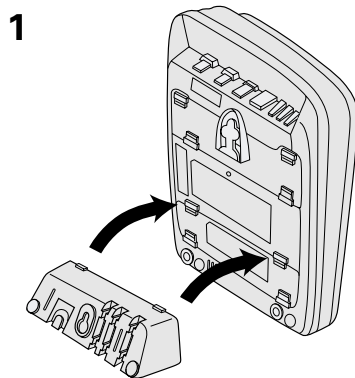

1 Attach the bottom bracket to the base as shown. Make sure all tabs snap into the notches on the base.

2 Plug the telephone line cord to the **TEL LINE** jack and the small plug of AC adaptor to the **DC IN 9V** jack.

3 Plug the telephone line cord into the telephone outlet.

4 Fit the AC adaptor cord into the molded groove. Then wrap the cord around the strain relief notch.

5 Plug the AC adaptor into a standard 120-V AC wall outlet.

6 Raise the antenna to a vertical position.

7 Align the mounting slots on the base with the mounting posts on the wall. Push in and down until the phone is firmly seated.

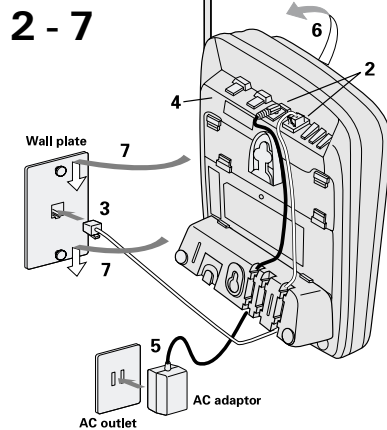

GETTING STARTED

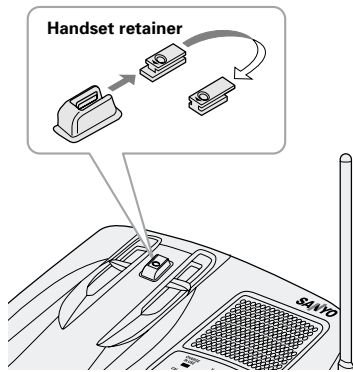

Note:

When the phone is mounted on the wall, the handset belt clip must be attached to hold the handset in the charging position. Do not place the handset with the display facing inside.

- 8 On the base unit, pull the handset retainer out of the slot. Rotate it clockwise 180 degrees.
- 9 Flip the retainer. Slide it back into the slot so that the lip of the retainer is up and the  points down. The retainer holds the handset in place.

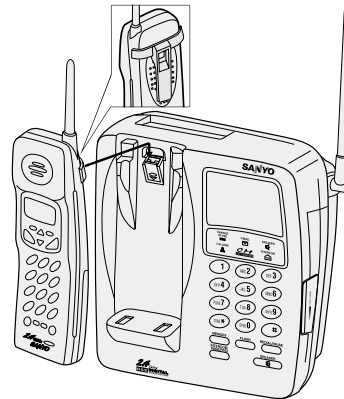

Direct wall-mounting

If you do not have a standard wall plate, you can still mount your phone directly to the wall. Before doing this, consider the following:

- Avoid electrical cables, pipes, or other items behind the mounting location, that could cause a hazard when inserting screws into the wall.
- Try to mount your phone within 10 – 15 feet (3 – 4.5 m) of a working phone jack to avoid excessive cord lengths.
- Make sure the wall material is capable of supporting the weight of the base and handset.
- Use # 10 screws with anchoring devices suitable for the wall material where the base unit will be placed.

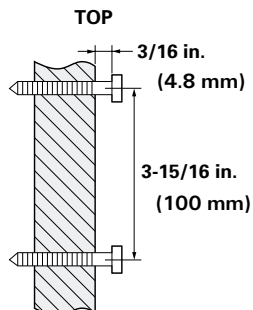

E8

- 1 Insert two mounting screws with a minimum length of 1-3/8 inches (35.5 mm) into the wall, 3-15/16 inches (100 mm) apart. Allow about 3/16 of an inch (4.8 mm) between the wall and screwheads for mounting the phone.
- 2 Refer to steps 1 through 9 on pages E7 and E8 to mount the telephone.

GETTING STARTED

Preparing the battery pack

Charge the battery pack for a full **15 hours** before you start using your phone.

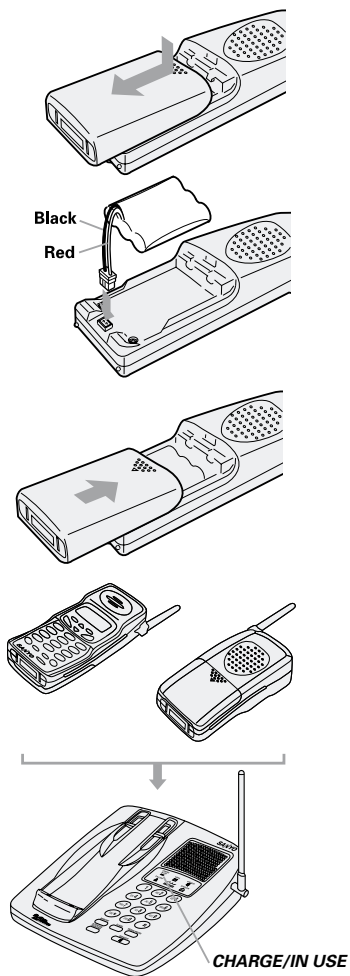

- 1** Press on the battery cover and slide the cover down until it comes off.
- 2** Plug in the battery pack connector with the correct polarity (black and red wires), then insert the battery pack into the battery compartment.
- 3** Slide the battery cover on until it snaps into place.
- 4** Place the handset on the base.
- 5** Make sure that the **CHARGE/IN USE** indicator lights. If the indicator does not light, check to see that the AC adaptor is plugged in and that the handset makes good contact with the base charging contacts.

Note:

Use only the battery pack supplied or the specified Sanyo types with your phone.
Type: SANYO 3KR-600AAL or SANYO/GE GES-PCF01

GETTING STARTED

Battery use time (per charge)

With a fully charged battery:

- Six hours continuous use.
- Seven days when the handset is in the standby mode.

When the battery charge level becomes low

When the voltage of the battery pack in the handset is very low and needs to be charged, the phone is programmed to stop functioning in order to save power.

Low Battery

If the phone is not in use, Low Battery flashes and none of the keys will operate. If the phone is in use, Low Battery flashes and the handset beeps. Complete your conversation as quickly as possible and return the handset to the base unit for charging.

Cleaning the battery contacts

To maintain a good charge, it is important to clean the battery contacts with a dry cloth on the handset and base unit about once a month.

Do not use any liquids or solvents.

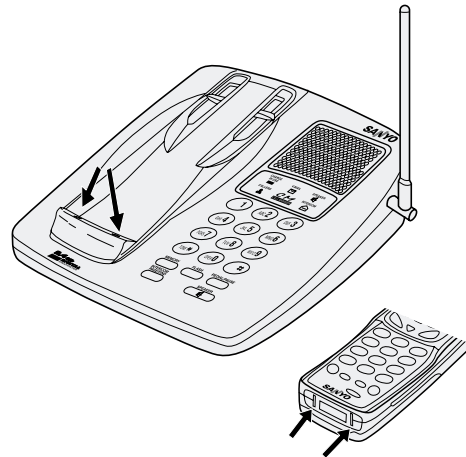

Note:

Repeated short chargings may cause memory effect in the battery pack, which reduces use time of the battery. It is recommended not to replace the handset to the base unit after each call.

E10

BASICS

Making a call

With the handset

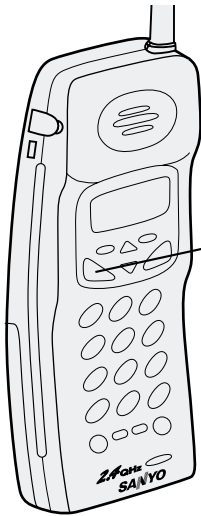

Dialing from standby mode

- 1 Enter the phone number. (Up to 32 digits.)
Example: Enter 9057609944

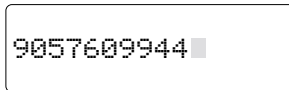

- 2 Press **TALK/END**. Talk flashes in the display.

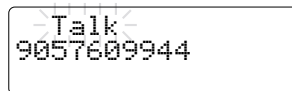

The volume setting is displayed. For example, if the volume is set to high, the display shows:

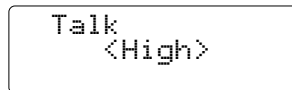

- 3 The number is dialed. The call time display appears about 5 seconds after line connection.

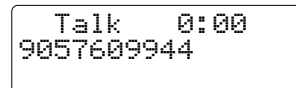

- 4 To hang up, press **TALK/END** (or place the handset on the base).
The call time display remains for about 5 seconds after disconnection.

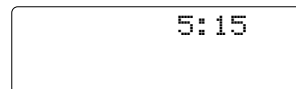

Notes:

- Press **DELETE/SCAN** if you enter a wrong number at step 1.
- Press and hold **DELETE/SCAN** to delete all numbers at once.
- You must press a key within 20 seconds or the phone will return to standby mode.

Other Operations

When you want to:	Do this:
Adjust the earpiece volume	Press or during the call.
Temporarily switch to tone dialing (When the base is set to pulse mode)	Press TONE/*/◀ . The subsequent numbers dialed will be sent as tone dialing.
Enter a pause in the dialing sequence	Press REDIAL/PAUSE .
Improve reception	Press DELETE/SCAN .

E11

BASICS

Dialing from talk mode

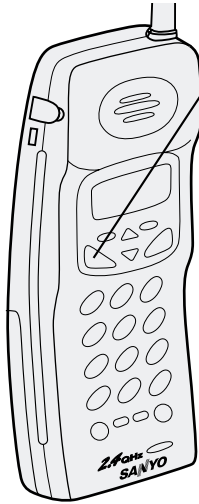

- 1** Press **TALK/END** or **SPEAKER** . Talk flashes on the display.
 Press **TALK/END** Press **SPEAKER**

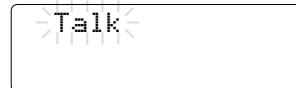

The volume setting is displayed.

For example, if the volume is set to high, the display shows:

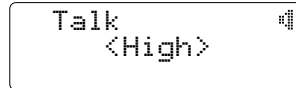
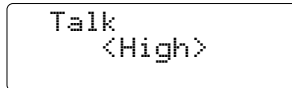

The call-time display appears.

- 2** Dial the phone number.
Example: Enter 9057609944

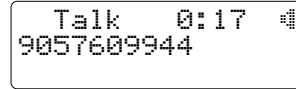

- 3** To hang up, press **TALK/END** or **SPEAKER** (or place the handset in the base). The call time display remains for about 5 seconds after disconnection.

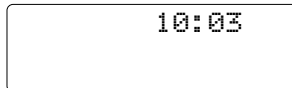

HandsFree Speakerphone in the Handset

- Press **SPEAKER** during a call to switch to HandsFree conversation using the handset speakerphone.
- Press **SPEAKER** again to end the call.
- Press **TALK/END** to return to normal conversation using the earpiece speaker.



BASICS

With the base

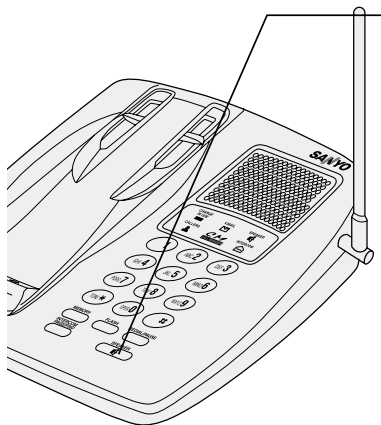

- 1** Press **SPEAKER** on the base. The **SPEAKER** indicator lights.
- 2** Dial the number on the keypad.
- 3** When you finish the call, press **SPEAKER** on the base to hang up.



BASICS

Receiving a call

With the handset

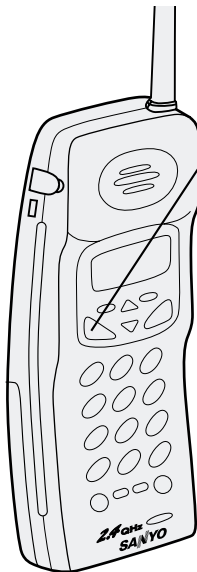

- 1** The phone rings. Incoming call appears.

Incoming Call

- 2** Press **TALK/END**. Talk, the call time display and the volume setting appear.
You can also press **SPEAKER** on the handset to answer the call.

Talk 0:00
<Normal>

If you subscribe to Caller ID service, the display may show the caller's name/number. (See page E30)

- 3** Talk with the caller.

Talk 0:02

- 4** To hang up, press **TALK/END**.
The call time display remains for about 5 seconds after disconnection.

5:15

Any key answer when ringing

When the handset is off the base, press any handset key to answer the incoming call.

AutoTalk when ringing

When the AutoTalk setting is on, you can simply lift the handset from the base to answer the call. See "Setting Caller ID options" on page E28 for more details.

BASICS

With the base

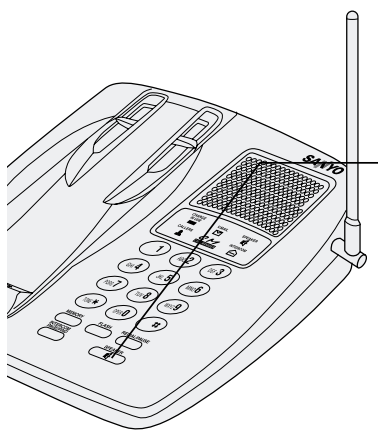

1 The base rings. The **CHARGE/IN USE** indicator flashes.

2 Press **SPEAKER**.

3 When you finish the call, press **SPEAKER** to hang up.

Call Waiting

Note: You must subscribe to Call Waiting service to use this feature.

When a call is received during a telephone call already in progress, you hear a beep. Press **CID/FLASH** to switch to the new call.

If you also subscribe to Caller ID on Call Waiting (Visual Call Waiting), you will see the name and number of the second caller. (See page E36.)

BASICS

Lighted keypad



The dialing keypad and the **TALK/END** key on the handset light up when you press any key on the keypad. The light turns off if no key is pressed for 5 seconds.

Scanning

Your phone automatically selects the clearest possible channel every time you receive or place a call. Should you wish to switch channels during a call, the handset provides a **DELETE/SCAN** button.

Adjusting the ringer and speaker volume

Ringer volume

In the standby mode, press **CALL REVIEW/VOLUME**  or  on the handset to set the handset ringer volume.

The phone has two ringer tones, each with two volume levels.

Ringer A High

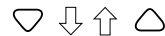

Ringer A Low

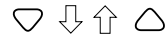





Ringer B High



Ringer B Low

Earpiece volume/handset speaker volume

Pressing **CALL REVIEW/VOLUME**  or  during a telephone call will change the earpiece volume/handset speaker volume. This setting will remain in effect even after you hang up the telephone.

When you press  in Loud mode or press  in Normal mode, a beep sounds.

<Loud>

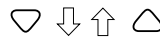

<High>



<Medium>



<Normal>

Base ringer switch

This switch sets the base ringer **HI**, **LOW**, or **OFF**.

Base speaker volume control

To control the speaker volume of the base, adjust the **VOLUME** slide switch as desired.

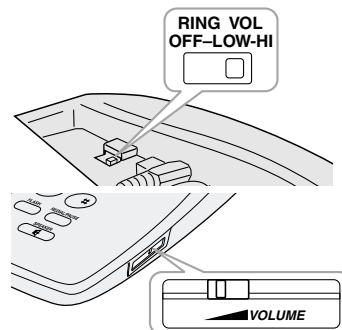

BASICS

Redialing a call

With the handset

The last three phone numbers dialed can be quickly redialed.



Redialing from standby mode

- 1** Press **REDIAL/PAUSE**.
The phone number that was last dialed appears in the display.
- 2** Press **REDIAL/PAUSE** again.
Each press of **REDIAL/PAUSE** will display one of the last three numbers dialed.

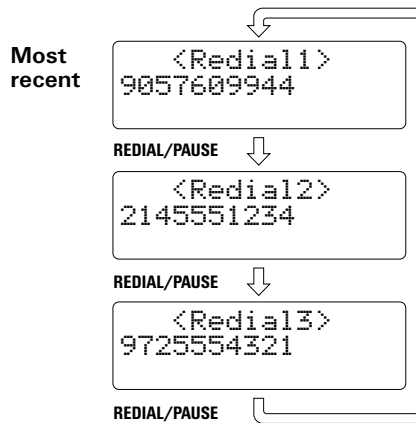

- 3** Press **TALK/END**. Talk appears in the display, then the volume setting is displayed.
- 4** Then the selected number is dialed. The call time display appears 5 seconds after line connection.
- 5** To hang up, press **TALK/END** (or place the handset on the base). The call time display remains for about 5 seconds.

Notes:

- If the dialed number exceeds 32 digits, only the first 32 digits are retained for redialing.
- If no number has been dialed, you hear an error tone and no redialing will be made.

E17

BASICS

Redialing from talk mode

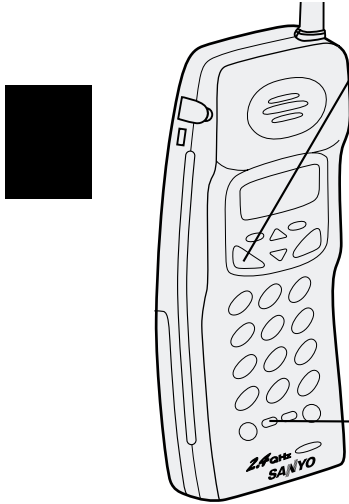

- 1** Press **TALK/END**.
Talk appears on the display.

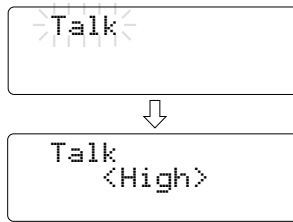

- 2** Press **REDIAL/PAUSE**.
The last number dialed will be displayed. Only the last number dialed can be accessed while in talk mode.

- 3** To hang up, press **TALK/END** (or place the handset on the base).

Notes:

- Only the last number dialed can be accessed after **TALK/END** has been pressed.
- If no number has been dialed using the handset, you hear an error tone and no redialing will be made.

With the base

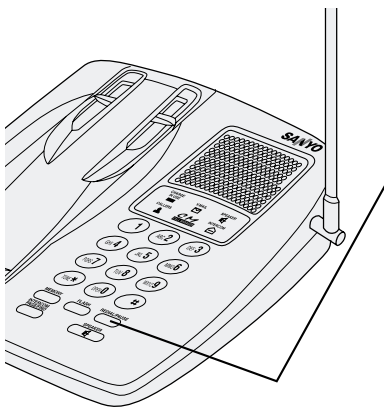

- 1** To call the last number dialed from the base, press **SPEAKER**.

- 2** Press **REDIAL/PAUSE**.
The last number dialed will be redialed.

- 3** To hang up, press **SPEAKER**.

E18

DIRECTORY/SPEED-DIAL

The handset and base each has its own memory for storing phone numbers. The handset directory can store 20 names/numbers, while the base speed-dial memory holds up to 10 numbers.

Telephone numbers stored in either the handset directory or base memory can be dialed using just a few key strokes.

Using the handset directory

Storing names/numbers

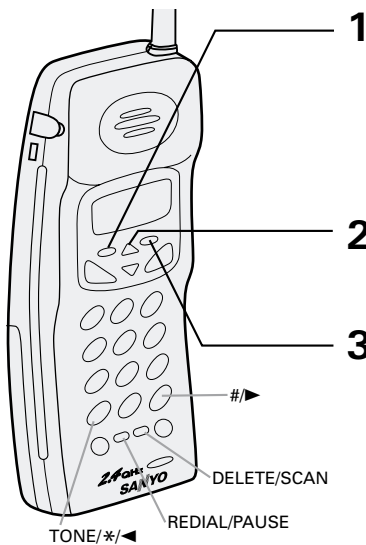

- 1 Press and hold **MEMORY** for about 2 seconds until **Memory Store** is displayed. A beep sounds.

```
Memory Store
01▶
02
```

- 2 Use \triangle or ∇ , or enter a two-digit number (01–20) to select the memory location where you want to store the number.

- 3 Press **INTERCOM/SELECT**. The following screen appears and a cursor flashes indicating that you can now enter the name.

```
Store Name
█
```

Note:

In memory store operation, you must press a key within 20 seconds or the phone will return to standby. If you return the handset to the base, it will return to standby, too.

If the following screen appears, the selected location is already occupied. Then you can either change the entry in this location, clear the location, or select **Go Back** to choose another location.

```
Edit Memory07
Delete Memory07
Go Back
```

- 4 Use \triangle , ∇ , $\#/\blacktriangleright$, $\text{TONE}/*/\blacktriangleleft$ or **DELETE/SCAN** to enter the name. The name cannot exceed 13 characters.
 - Use \triangle or ∇ to scroll through the character menu. It contains upper and lower case letters and various characters.
 - Use $\#/\blacktriangleright$ and $\text{TONE}/*/\blacktriangleleft$ to move the cursor to the desired location.
 - Press briefly **DELETE/SCAN** to delete a character.
 - Press and hold **DELETE/SCAN** to delete all numbers and characters at once.

E19

DIRECTORY/SPEED-DIAL

- 5** Press **INTERCOM/SELECT**.
Store Number is displayed.
The cursor flashes indicating that you can now enter the number.

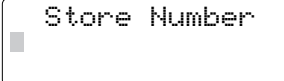

Store Number

- 6** Use the number keypad or **REDIAL/PAUSE** to enter the phone number.
The phone number cannot exceed 20 digits.

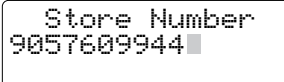

Store Number
9057609944

- Use **REDIAL/PAUSE** to enter a pause in the dialing sequence.
The display shows a P.

Note:

The pause feature is useful for long distance calling, credit card dialing, or sequences that require a pause between certain digits.

- Use **DELETE/SCAN** to delete digits as needed.
- Press and hold **DELETE/SCAN** to delete all digits at once.

- 7** Press **INTERCOM/SELECT**.
The handset beeps and displays the confirmation screen.
Memory storage is complete.
For example, if you store a name and number into memory location number 07, the display shows Memory07 Stored.
After about 2 seconds, Memory Store is displayed.



Memory07 Stored

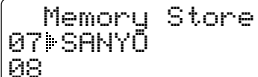

Memory Store
07 SANYO
08

- 8** Press **MEMORY** to return to standby mode.

DIRECTORY/SPEED-DIAL

Making calls from the handset directory

Memory dialing from standby mode

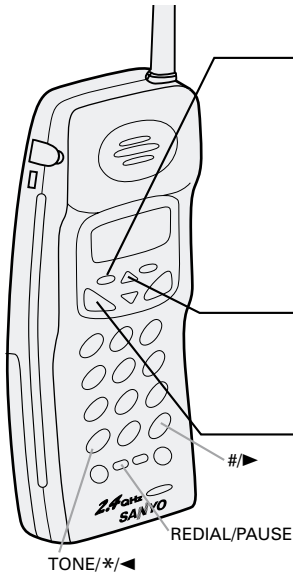

- 1 Press **MEMORY**.
The handset displays your programmed memory locations.
A beep sounds.

```

01# SANYO
02 Alison McNab
03 MOM AND DAD
    
```

- 2 Press \triangle and ∇ , or enter a two-digit number (01–20) to select the memory location you would like to dial.

- 3 Press **TALK/END** or **SPEAKER** ☞ . Talk and the volume setting appear on the display. Then the displayed number is dialed.

Press **TALK/END**

```

>Talk<
0123456789012
    
```



```

Talk
<Medium>
    
```

Press **SPEAKER** ☞

```

>Talk<
0123456789012
    
```



```

Talk
<Medium> ☞
    
```

Notes:

- If you press **INTERCOM/SELECT** before **TALK/END**, you can confirm the name and number stored in the selected memory location.
- To exit the memory function without dialing, press **MEMORY**. The handset returns to standby.

DIRECTORY/SPEED-DIAL

Display a programmed number

Use **#/▶** and **TONE/*/◀** to toggle between the name display and the number display.

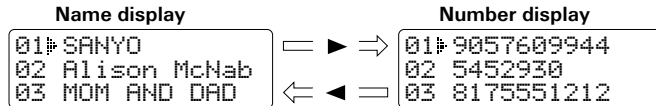

Note: When the stored phone number has 14 or more digits, "➔" is displayed next to the 12th digit. Press **#/▶** to see the extra digits and **TONE/*/◀** to return.

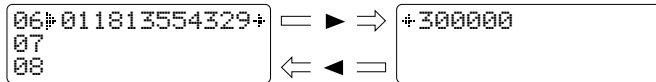

Memory dialing from Talk mode

- 1 Press **TALK/END** or **SPEAKER** .
Talk and the volume setting appear.

Press **TALK/END**

>Talk<



Talk
<High>

Press **SPEAKER**

>Talk<



Talk
<High> 

- 2 Press **MEMORY** .

Talk 0:00

Talk 0:00 

- 3 Enter a two-digit number (01–20) to select the memory location of the desired phone number.
The selected phone number is displayed. Then the number is dialed.

Talk 0:35
0123456789012

DIRECTORY/SPEED-DIAL

Editing a stored name and/or phone number

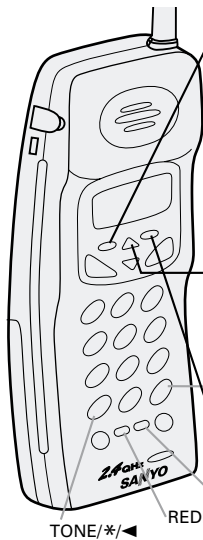

- 1** Press and hold **MEMORY** until the display shows the Memory Store screen and any stored name/number.
A beep sounds.

```
Memory Store
01 SANYO
02 Alison McNab
```

- 2** Press \triangle and ∇ , or enter a two-digit number (01-20) to select the memory location you want to edit.

```
Memory Store
01 SANYO
02 Alison McNab
```

- 3** Press **INTERCOM/SELECT**.
The following screen appears with the memory location number that you have selected in the display.

```
Edit Memory02
Delete Memory02
Go Back
```

- 4** Press \triangle or ∇ to select **Edit Memory**, then press **INTERCOM/SELECT**.
The following screen appears.
The cursor flashes indicating that the name can be edited. When a name has not been stored, the cursor appears at the beginning of the second line.

```
Store Name
Alison McNab
```

- 5** Press \triangle , ∇ , $\#/\blacktriangleright$, $\text{TONE}/\text{*/}\blacktriangleleft$ or **DELETE/SCAN** to edit the name. (See page E19.)
To edit only the phone number, skip this step.

- 6** Press **INTERCOM/SELECT**.
The following screen appears.
The cursor flashes indicating that the display is ready for the number to be edited.

```
Store Number
5452930
```

DIRECTORY/SPEED-DIAL

- 7** Use the number keys, **REDIAL/PAUSE**, **DELETE/SCAN**, **#/▶**, or **TONE/*/◀** to edit the phone number.
 The phone number cannot exceed 20 digits. (See page E20.)
 When the phone number will not be edited, skip this step.

- 8** Press **INTERCOM/SELECT**.
 The handset beeps and displays the confirmation screen. The memory storage is complete.
 For example, if you store a name and number into memory location number 02, the display shows Memory02 stored.
 After about 2 seconds, Memory Store is displayed.

```
Memory02 Stored
```

```
Memory Store
01 SANYO
02▶Alison McNab
```

- 9** Press **MEMORY** or place the handset on the base to return to standby mode.

Display a programmed number

Use **#/▶** and **TONE/*/◀** to switch between the name display and the number display.

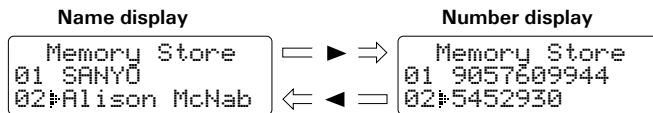

- When the stored phone number has 14 or more digits, "▶" is displayed next to the 12th digit.
 Press **#/▶** to see the extra digits and **TONE/*/◀** to return.

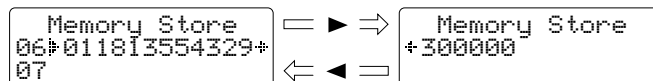

DIRECTORY/SPEED-DIAL

Erasing a stored name and phone number

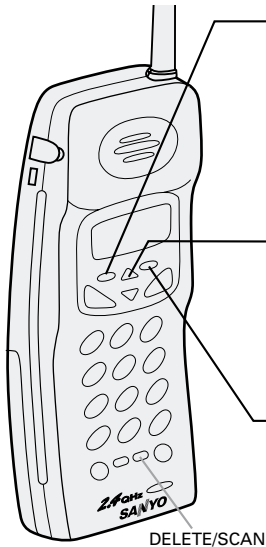

- 1** Press and hold **MEMORY** until the display shows the Memory Store screen and any stored name/number. A beep sounds.

```
Memory Store
01▶SANYO
02 Alison McNab
```

- 2** Press \triangle and ∇ , or enter a two-digit number (01- 20) to select the memory location you want to edit.

```
Memory Store
01 SANYO
02▶Alison McNab
```

- 3** Press **INTERCOM/SELECT**. The following screen appears with the memory location number that you have selected in the display.

```
▶Edit Memory02
Delete Memory02
Go Back
```

- 4** Press ∇ to move the cursor down to the Delete Memory command line.

```
Edit Memory02
▶Delete Memory02
Go Back
```

- 5** Press **INTERCOM/SELECT**. The following confirmation screen appears.

```
Delete Memory02?
Yes
▶No
```

- 6** Press \triangle to move the cursor to Yes.

- 7** Press **INTERCOM/SELECT** or **DELETE/SCAN**. There is a confirmation tone and the entry is deleted. The following screen appears.

```
Memory02 Deleted
```

- 8** After a few seconds the display returns to the Memory Store screen. You may select another number to delete (return to step 4) or press **MEMORY** to return to standby.

```
Memory Store
01 SANYO
02▶
```

DIRECTORY/SPEED-DIAL

Using the base station speed-dial memory

Storing numbers in the speed-dial memory

You can store only numbers in the base memory.

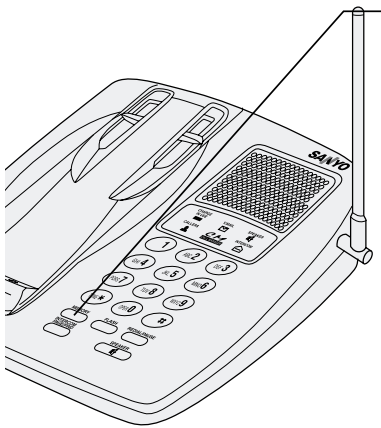

- 1** Press **MEMORY**. The **CHARGE/IN USE** indicator blinks.
- 2** Dial the number you want to store. (up to 16 digits)
- 3** Press **MEMORY** and enter the memory location number (0–9) on the keypad. A confirmation tone sounds.

Note:

If you store a phone number in one of speed-dial locations and attempt to store different number in the same location later, the new number will replace the previous one.

Note:

You cannot use the speed-dial memory feature from the handset and the handset directory from the base station.

DIRECTORY/SPEED-DIAL

Dialing a number from the speed-dial memory

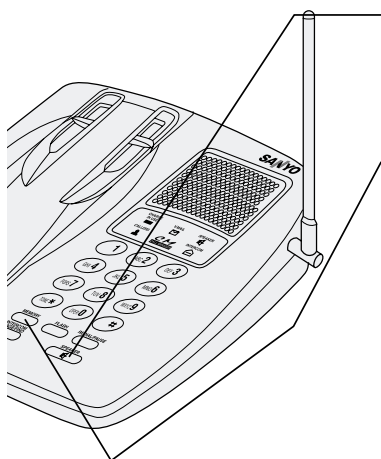

- 1** Press **SPEAKER**. The **SPEAKER** indicator lights.
- 2** Press **MEMORY** and enter the memory location number (0-9) on the keypad. Then the stored number will be dialed.



Erasing a number in the speed-dial memory

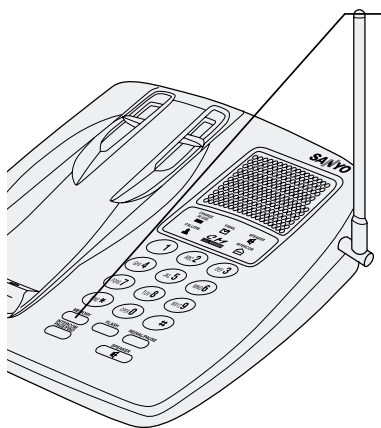

- 1** Press **MEMORY**. The **CHARGE/IN USE** indicator blinks.
- 2** Press **MEMORY** again.
- 3** Enter the memory location number (0-9) you want to delete. A confirmation tone sounds and the number is erased.

CALLER ID FEATURES

Caller ID

You must subscribe to the Caller ID service from your local telephone company to use this feature.

When the telephone rings, the Caller ID feature allows you to view the caller's name and phone number on the display before you answer the phone.

When you review the Caller List, the handset displays the phone number of the incoming calls, the caller's name, time called, and the number of calls received. You can dial the displayed number and store the information in the directory for memory dialing.

Note:

You must subscribe to Caller ID on Call Waiting (Visual Call Waiting) if you want to see the name/number of the second caller while you are already on the phone. (See page E36.)

Setting Caller ID options

There are four Caller ID setup options available:

- AutoTalk On/Off,**
- CIDCW (Caller ID on Call Waiting) On/Off/Opt,**
- Area Code** and
- Language (English or French).**

See next page for more detailed instructions.

AutoTalk On/Off allows you to turn on or off the AutoTalk feature that automatically turns the handset into talk mode when you pick it up from the base. The factory default setting is Off.

Note:

When you subscribe to Caller ID service, you may not want to answer every incoming call before you know who is calling. When AutoTalk is set to off, you must press **TALK/END** to answer the call.

Caller ID on Call Waiting (CIDCW) performs the same as regular Caller ID on a second call. **You must subscribe to this service (Visual Call Waiting, for example) from your phone company in order to use this feature.**

The **Area Code** option can be used to program your area code in the Caller ID memory. When an incoming call has the same area code as yours, the phone automatically recognizes it as a local number and drops the area code when dialing or storing the number directly from the Caller ID list. You may wish to enter your local area code before you use this phone for the first time or if you move to a new area.

The **Language** option can be used to choose the language of your display. You can choose either English or French.

Note:

If your calling area requires 10-digit dialing, skip this step.

E28

CALLER ID FEATURES

To change your Caller ID options:

- 1** Press **SERVICE MENU**. The following screen appears:

```
Select Service
1#Voice Mail
2 Network Svc
```

- 2** Press **3** (or **▽** twice) to select Option, then press **INTERCOM/SELECT**.
The following screen appears:

```
1#Auto Talk:Off
2 CIDCW      :On
3 Area Code:
```

- 3** Use **△** or **▽** to move the cursor to the selection that you would like to change.
Press **INTERCOM/SELECT** to switch between On and Off for Auto Talk.
Press **INTERCOM/SELECT** to switch between On, Off and Opt for CIDCW.

- 4** To program your Area Code, press **▽** to move the cursor to select Area Code.
Then press **INTERCOM/SELECT** and enter the 3-digit area code by using the number keypad **0** - **9**. After entering your Area Code, press **INTERCOM/SELECT**.

- 5** To set up the language of your display, press **▽** to move the cursor to
4 Language.

Press **INTERCOM/SELECT** to select Eng (English) or Fr (French).

```
2 CIDCW      :On
3 Area Code:
4#Language :Eng
```

- 6** After you have made your selections, press **SERVICE MENU** to return to standby.

Note:

CIDCW Settings

- When you subscribe to Call Waiting or Visual Call Waiting service, select On.
- When you subscribe to Call Waiting with Options service (Call Director), select Opt. Please see page E47 for more information.

CALLER ID FEATURES

When the telephone rings

- 1 When a call is received, the display shows the caller's phone number, along with the date and time. The incoming call information is stored in the Caller ID list. If the Caller ID service includes the caller's name, it appears on the display (up to 15 letters).

Number of calls from the same phone number
 The date and time received
 Caller's name
 Caller's phone number

```

5/11 12:30PM 01
SANYO
905-760-9944
    
```

Here are some typical displays:

When the phone number and name data are received

```

5/11 12:30PM 01
SANYO
905-760-9944
    
```

When invalid data is received

```

Incomplete Data
    
```

When a private name is received

```

5/11 12:30PM 01
Private Name
905-760-9944
    
```

When a private number is received

```

5/11 12:30PM 01
SANYO
Private Number
    
```

When an unknown name is received

```

5/11 12:30PM 01
Unknown Name
905-760-9944
    
```

When an unknown number is received

```

5/11 12:30PM 01
SANYO
Unknown Number
    
```

- 2 When you answer the call, the display changes to Talk. (See page E14.)



Data errors appear as "■".

```

5/11 12:30PM 01
SAN■
905-7■■-9944
    
```

Notes:

- If you answer a call before the Caller ID data is received (Example: before the second ring), the Caller ID display will not appear.
- When the call is via a private branch exchange (PBX), the caller's phone number and name may not appear.
- When the call is received via a telephone company that does not offer Caller ID service, the caller's phone number and name do not appear. (This includes international calls.)
- When new Caller ID data is received, the **CALLERS** indicator on the base flashes.

E30

CALLER ID FEATURES

Viewing the Caller ID list

The Caller ID list stores information for up to 50 incoming calls including unanswered calls.

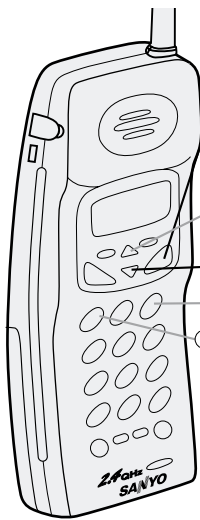

- 1** Press **CID/FLASH**.
The summary screen appears.
The screen shows the number of new calls and total calls.

```
New :01
Total:02
```

- 2** Press ∇ to display the latest caller information.

```
5/17 12:30PM 03
SANYO
905-760-9944
```

- 3** Press ∇ to see the next caller.
Or press \triangle to see previous caller.

- 4** Press **CID/FLASH** or return the handset on the base to return to standby.

Notes:

- In Caller ID operation, if no key is pressed for more than 20 seconds, an error tone sounds and the telephone returns to the standby mode.

Long distance number and area code setting

To call back a long distance number from the Caller ID list, press $\textcircled{1}$ while the number is displayed in step 2. The prefix 1- will be displayed at the beginning of the phone number. (When the phone number is 15 digits or longer, only 1 is displayed.)

```
5/17 12:30PM 03
SANYO
1-905-760-9944
```

Press $\textcircled{1}$ again to remove the long distance prefix 1-.

Press $\textcircled{3}$ to add or delete the area code from the displayed phone number.

Note:

The phone numbers and names of the Caller ID list can be up to 15 characters each.

CALLER ID FEATURES

Deleting information from the Caller ID list

The Caller ID list of the CLT-2430 stores up to 50 entries. If the phone receives the 51st call, the oldest one in the list is automatically deleted.

Any Caller ID entry can be deleted manually.

Deleting a Caller ID entry

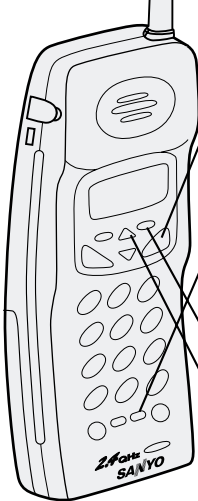

- 1** Press **CID/FLASH**.
Display the name/number to be deleted from the Caller ID list by pressing \triangle or ∇ .

5/17 12:30PM 03
SANYO
905-760-9944

- 2** Press **DELETE/SCAN**.

Delete Message?
▶ Yes
No

- 3** Press \triangle or ∇ to select Yes or No.

- 4** Press **INTERCOM/SELECT** or **DELETE/SCAN**.

When the pointer is at Yes:
A beep tone sounds and the next Caller ID name/number is displayed.

When the pointer is at No:
The display returns to the Caller ID display.

Note:

If you receive an incoming call, the deleting operation is cancelled.

CALLER ID FEATURES

Deleting all Caller ID names/numbers

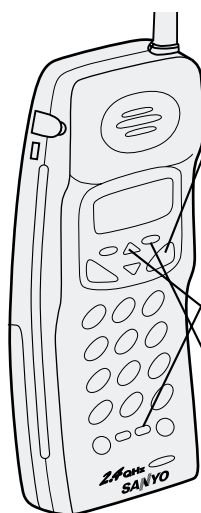



1 Press **CID/FLASH**.

```
New :01
Total:02
```

2 Press **DELETE/SCAN**.

```
Delete All?
Yes
No
```

3 Press  or  to select Yes or No.

4 Press **INTERCOM/SELECT** or **DELETE/SCAN**.

When the pointer is at Yes:

A beep tone sounds and all stored Caller ID entries are deleted.

```
Total:00
```

When the pointer is at No:

The display returns to the summary screen.

```
New :01
Total:02
```

Note:

If you receive an incoming call, the deleting operation is cancelled.

CALLER ID FEATURES

Using the Caller ID list

Calling a party from the Caller ID list

You can place a call from the Caller ID list.

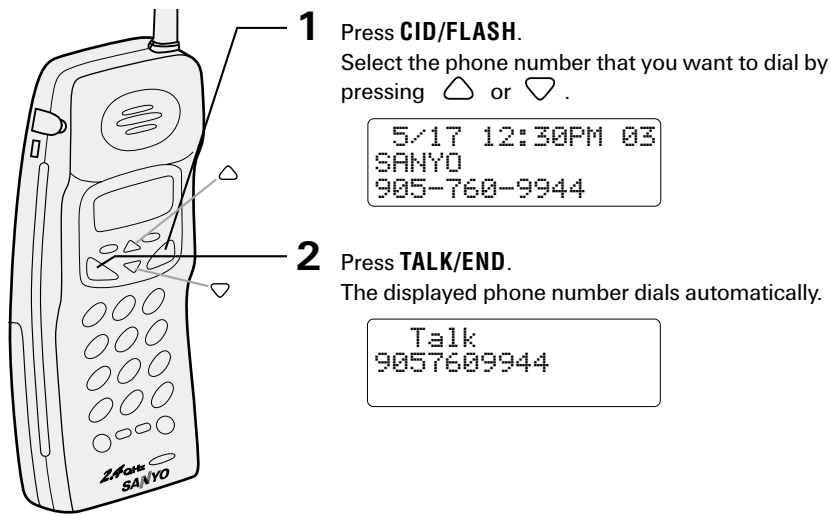

Notes:

- When a long distance number is selected, 1 appears in the display.
- You cannot make a call from the Caller ID list if your CLT-2430 is connected to private branch exchange (PBX).

Long distance numbers

Press $\textcircled{1}$ to add or remove the long distance prefix 1- from the displayed number in step 1.

Area code setting

Press $\textcircled{3}$ to add or delete the area code from the displayed number.

Number editing

Press **INTERCOM/SELECT** after step 1 to edit the displayed phone number.

CALLER ID FEATURES

Storing a Caller ID entry in the directory memory

Names and numbers shown in the Caller ID list can be stored in the directory memory.

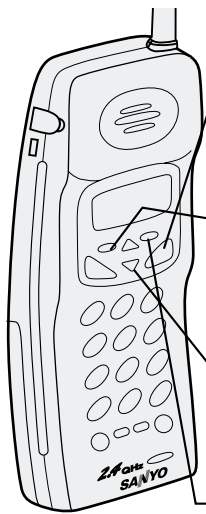

- 1** Press **CID/FLASH**.
Select the phone number to be stored from the Caller ID list by pressing \triangle or ∇ .

5/17 12:30PM 03
SANYO
905-760-9944

- 2** Press **MEMORY**.

Select Location
01 SANYO
02 Alison McNab

- 3** Press \triangle or ∇ to select the memory location.

Or press the dial button ($\textcircled{0}$ - $\textcircled{9}$) and select the number (01-20).

- 4** Press **INTERCOM/SELECT**.
A beep tone will sound. The number is stored in memory and the display returns to the Caller ID list.

5/17 12:30PM 03
SANYO
905-760-9944

Notes:

- You cannot store a Caller ID entry that includes no phone number.
- If there is an incoming call or page during memory storing, the operation is cancelled and the telephone is set to receive the incoming call or page.



If a number has already been stored in the selected memory location of the directory,

Replace Memory?
Yes
No

a confirmation screen is displayed. Press \triangle to select Yes.

Press **INTERCOM/SELECT** to overwrite. The display returns to the Caller ID list.

CALLER ID FEATURES

Using Caller ID on Call Waiting service

Caller ID and **Call Waiting** are separate services. **Caller ID on Call Waiting (CIDCW or Visual Call Waiting** for example) performs the same as regular Caller ID on a waiting call. You must subscribe to the Caller ID on Call Waiting service before you can use the following features. The Call Waiting service can also be used independently. Please contact your telephone company for details.

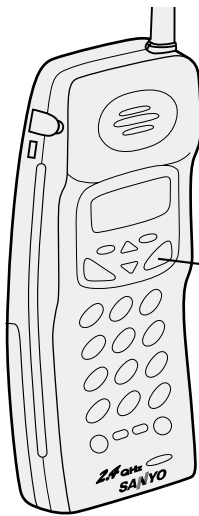

- 1 When an incoming call arrives while you are already on the phone, you hear a beep and the phone number and name of the new caller is displayed.

```
Talk    10:30
SANYO
905-760-9944
```

- 2 Press **CID/FLASH**. You will be able to talk with the second caller. The first caller will be put on hold.

- 3 To return to the first caller, press **CID/FLASH** again.

Note:

When you subscribe to Call Waiting with Options service and CIDCW is set to Opt. in the Caller ID setup menu, you can press the **CID/FLASH** key after receiving a call waiting signal and view a list of options for handling the new call. Choose an option using the \triangle and ∇ keys and press **INTERCOM/SELECT** to activate. (See pages E29 and E47.)

ADVANCED CALLING FEATURES

You can access a list of calling services provided by your local telephone company by using the **SERVICE MENU** key on the handset. You may be required to subscribe to these services before they can be used. Please contact your local telephone company for more details or subscription. Availability of these services varies.

Note:

A subscription may be required and fees may apply for using each of the features listed below. Contact your local telephone company for more details or subscription.

List of features

Voice Mail* Access (page E38)

Many telephone companies offer an electronic mailbox service. When you subscribe to this service, your callers can leave messages for you. The CLT-2430 allows you to program your Voice Mailbox access number into its memory for quick retrieval of your messages.

Network Features (page E43)

The following calling features offered by many telephone companies are pre-programmed for easy access.

- Last Call Return
- Busy Call Return
- Cancel Call Waiting
- Select Blocking

Call Waiting with Options (page E47)

The following options are pre-programmed to use with Call Waiting with Options (Call Director) service.

- Switch/FLASH
- Ask to hold
- Tell busy
- Take message
- Answer/drop first
- Conference
- Drop first
- Drop last

ADVANCED CALLING FEATURES

Voice Mail access

If you subscribe to voice mail service, you can program your CLT-2430 to easily access your voice mailbox. The voice mail indicator on the base of your phone flashes whenever you have messages waiting in your voice mailbox.

Programming your access number

- 1** Press and hold **SERVICE MENU**.

```

Edit Service
01 Voice mail
02 Network Svc
  
```

- 2** Press **INTERCOM/SELECT**.
The handset displays:

```

Store Number
  
```

If you have previously stored a number, the display will show:

```

Edit Number
Delete Number
Go Back
  
```

- 3** Enter your Mailbox access number.

- 4** Press **INTERCOM/SELECT**. You will hear a long beep and the display shows:

```

Number Stored
  
```

Note:

You must subscribe to a voice mail service from your telephone company in order to use this feature.

Retrieving your voice mail messages

The **VOICE MAIL** indicator on the base will flash when you have received new voice messages.

- 1** To access your Voice Mailbox, press **SERVICE/MENU** and select **VOICE MAIL**.
- 2** Then press **TALK/END** or **SPEAKER**.

E38

ADVANCED CALLING FEATURES



Resetting the message waiting indicator

You may need to occasionally reset the **VOICE MAIL** indicator if it remains on after you have retrieved your messages.

To reset the indicator, put the handset on the base then press and hold the **INTERCOM/PAGE/FIND** key for two seconds, or until the indicator stops flashing.

ADVANCED CALLING FEATURES

Call transfer feature

Transferring a call

To transfer from the handset to the base

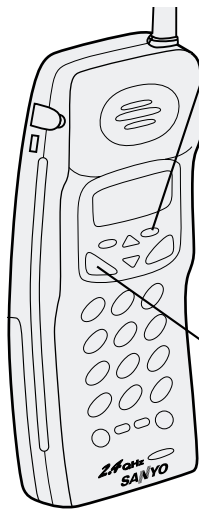

- 1 Press **INTERCOM/SELECT** on the handset during Talk mode. The caller is put on hold and a series of beeps sound on the base.

Hold
Paging Base

- 2 Press **INTERCOM/PAGE/FIND** or **SPEAKER** on the base. The intercom mode is activated, but the caller is still on hold.
- 3 To transfer the call to the base, press **TALK/END** on the handset. To cancel the transfer, press **SPEAKER** on the base.

To transfer from the base to the handset

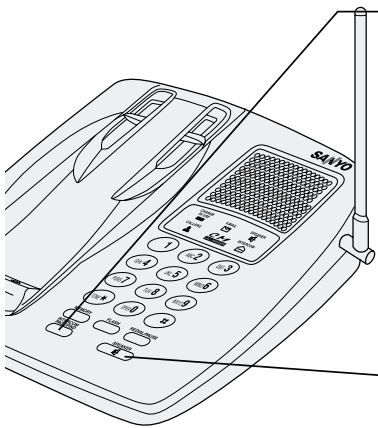

- 1 Press **INTERCOM/PAGE/FIND** on the base during speaker phone mode. The caller is put on hold and a series beeps sound on the handset.

Hold
Paging

- 2 Press **INTERCOM/SELECT** or **TALK/END** on the handset. The intercom mode is activated, but the caller is still on hold.
- 3 To transfer the call to the handset, press **SPEAKER** on the base. To cancel the transfer, press **TALK/END** on the handset.

E40

ADVANCED CALLING FEATURES

Intercom feature

Using the intercom of your phone

Paging from the base to handset

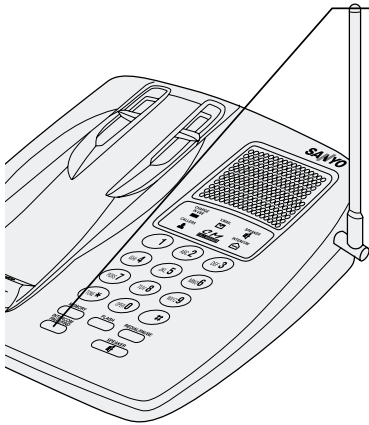

- 1 Press **INTERCOM/PAGE/FIND** on the base. The handset beeps. (If the handset does not answer, press **INTERCOM/PAGE/FIND** again to disconnect.)

Paging

The **INTERCOM** indicator on the base flashes.

- 2 Press **INTERCOM/SELECT** or **TALK/END** on the handset to answer. "Intercom" appears on the display.
- 3 To turn off the intercom, press **TALK/END** on the handset or **SPEAKER** on the base.

Paging from the handset to base

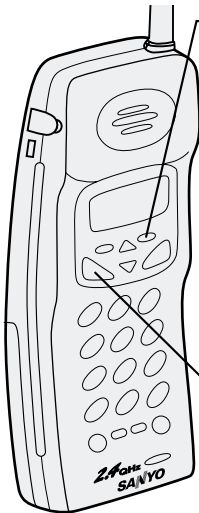

- 1 Press **INTERCOM/SELECT** on the handset. (If the base does not answer, press **INTERCOM/SELECT** again to disconnect.)

Paging Base

The **INTERCOM** indicator on the base flashes.

- 2 At the base, press **INTERCOM/PAGE/FIND** or **SPEAKER** to answer. Speak into the base microphone.
- 3 To turn off the intercom, press **TALK/END** on the handset or **SPEAKER** on the base.

Note:

- If the page is not answered within one minute, the paging stops automatically.
- The **CHARGE/IN USE** and **INTERCOM** indicators light during intercom conversation.

E41

ADVANCED CALLING FEATURES

3-way conference feature

3-way conference

The CLT-2430 allows 3-way conversation between the handset, base and an outside line.

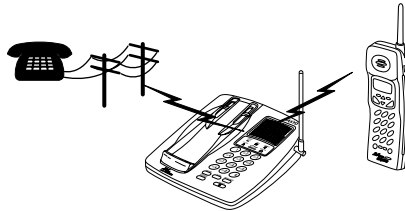

When a call is in progress on the handset

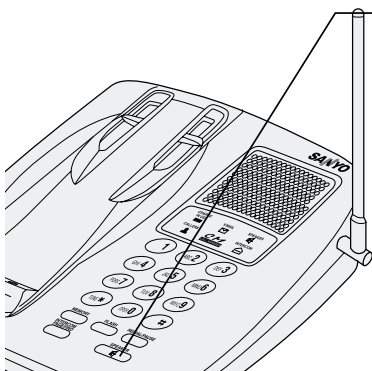

- 1** Press **SPEAKER** on the base.
This will establish the 3-way conversation mode.
- 2** Press **SPEAKER** on the base to cancel the 3-way conference. The handset remains connected to the outside line.

When a call is in progress on the base

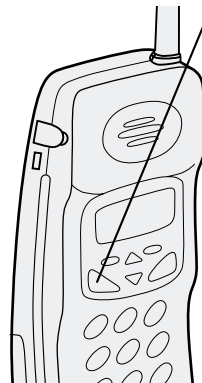

- 1** Press **TALK/END** on the handset.
This will establish the 3-way conversation mode.
- 2** Press **TALK/END** on the handset to cancel the 3-way conference. The base remains connected to the outside line.

E42

ADVANCED CALLING FEATURES

Accessing calling features

To access the network calling features programmed into your phone, follow the instructions below. General descriptions of each service are given in the following section. For complete instructions for using each service, please contact your local telephone company.

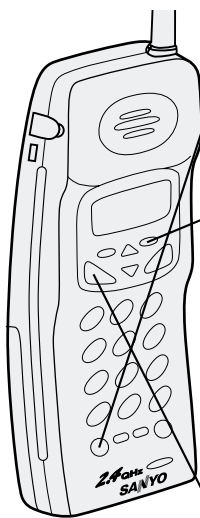

- 1** Press **SERVICE MENU**.
The following screen appears.

```
Select Service
1 Voice mail
2 Network SVC
```

- 2** Use ∇ or press **(2)** to select **Network SVC** and then press **INTERCOM/SELECT**.
The display shows the pre-programmed calling features.

```
01 Call Return
02 Busy Redial
03 CncI Call Wtg
```

- 3** Use the \triangle or ∇ key or enter a two-digit number (01-12) to select the feature you would like to use.

- 4** Press **TALK/END** or **SPEAKER**. **Talk** and the volume setting appear for a few moments. The display shows the activation code being dialed.

```
Talk
*69
```

Note:

You must select a service from the menu before pressing **TALK/END** (or **SPEAKER**).

Notes:

- When using certain calling features, local toll or long distance charges may apply.
- Certain calling features may not be used on some long distance calls or from certain types of business lines.

ADVANCED CALLING FEATURES

Pre-programmed calling features

The following calling features and activation codes are pre-programmed in the CLT-2430. Activation codes may vary depending on local telephone company. See next page to reprogram a different code of any of these features.

No.	Calling feature	Display	Preprogrammed activation codes
01	Last Call Return	Call Return	*69
02	Busy Call Return	Busy Redial	*66
03	Cancel Call Waiting	Cncl Call Wtg	*70
04	Select Blocking	Select Block	*67

Displaying the pre-programmed activation codes

Use the **TONE/*/◀** and **#/▶** keys to switch between the calling feature and its activation code.

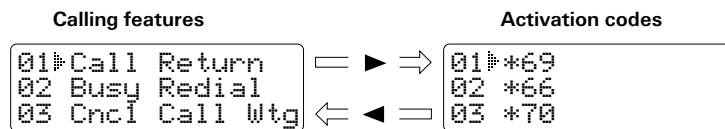

Descriptions of calling features

The following descriptions are typical and may vary depending on local calling area and service availability. For complete instructions, please contact your telephone company.

Last Call Return remembers the number of the person who called you last and automatically dials that number. This feature is useful if you just missed an incoming call.

Busy Call Return continually redials a busy number for you. When a number is busy, Busy Redial monitors the busy number and lets you know when the line is free.

Cancel Call Waiting temporarily cancels call waiting service. This feature is useful if you have call waiting service, but don't want to be disturbed during a call.

Select Blocking allows you to block your caller ID information from being displayed to the party you are calling. Select this option before dialing.

ADVANCED CALLING FEATURES

Adding new features

The last eight calling feature locations are available for you to program new features into your CLT-2430. You may also reprogram features in any of the other locations or restore the pre-programmed service at any time.

Add or edit a service

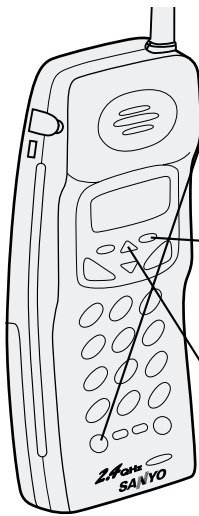

- 1 Press and hold **SERVICE MENU**.
The following screen appears.
Use ∇ or press $\textcircled{2}$ to select Network Svc.

```

Edit Service
1 Voice mail
2 Network Svc
    
```

- 2 Press **INTERCOM/SELECT** and the edit menu is displayed.

```

Select to Edit
01 Call Return
02 Busy Redial
    
```

- 3 Use the \triangle and ∇ keys to select the feature location you would like to edit.

```

Select to Edit
01 Call Return
02 Busy Redial
    
```

- 4 Press **INTERCOM/SELECT**.
The following screen appears with the service location number that you have selected in the display.

```

Edit Svc02
Restore Svc02
Go Back
    
```

You can restore a feature to its original pre-programmed service. Just select **Restore Svc02** and follow the instructions below.

If you have selected **Restore Svc02**, the following display appears:

```

Restore Svc02?
Yes
No
    
```

Select **Yes** to restore Busy Redial. The following display appears. The phone returns to step 2.

```

Service Setting
Restored
    
```

ADVANCED CALLING FEATURES

- 5** Press **INTERCOM/SELECT** to edit the feature stored in location two.
The following screen appears:

```
Service Name
Busy Redial█
```

The cursor flashes indicating that the name can be edited. Use the **TONE/*/◀** and **#/▶**, **△** and **▽** keys to enter a new name.

Press the **DELETE/SCAN** key to delete a character.
Press and hold **DELETE/SCAN** to delete all characters at once.

- 6** Press **INTERCOM/SELECT** when you have entered a new name.
The following screen appears:

```
Service Number
*66█
```

The cursor flashes indicating that the code can be edited or entered. Use the keypad to enter a new code.

If you enter a wrong digit, press **DELETE/SCAN**.
To delete wrong digits all together, press and hold **DELETE/SCAN**.

- 7** Press **INTERCOM/SELECT**. The following screen appears:

```
Service02 Stored
```

- 8** Press **SERVICE MENU** or return the handset to the base to return to standby mode.

ADVANCED CALLING FEATURES

Call Waiting with Options

This feature gives you more options for Caller ID on Call Waiting (Visual Call Waiting). At the touch of a button, you can ask the waiting caller to hold, send the caller to your voice mail service or have a conference with both first and second callers. You may be required to subscribe to voice mail service, Call Waiting and Call Waiting with Options to use these features. Not all features are available in all areas. Check with your local telephone company for details.

Setting CIDCW option

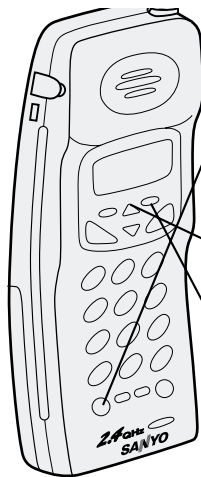

- 1 Press **SERVICE MENU**.
- 2 Press **3** (or **▽** twice) to select **Option**, then press **INTERCOM/SELECT**. The following display appears.

```
1 Auto Talk:off
2 CIDCW      :on
3 Area code:
```

- 3 Press **▽** to select **CIDCW**.

```
1 Auto Talk:off
2 CIDCW      :on
3 Area code:
```

- 4 Press **INTERCOM/SELECT** to select opt.

```
1 Auto Talk:off
2 CIDCW      :opt
3 Area code:
```

Selecting an option

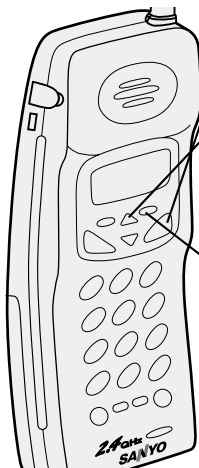

- 1 When you receive a call waiting signal, you may see the caller's name/number in the display. Press **CID/FLASH** for a list of options.

- 2 Press the **▽** key or enter a number (1-8) to select an option.

```
1 Switch/FLASH
2 Ask to Hold
3 Tell Busy
```

- 3 Press **INTERCOM/SELECT**. A confirmation screen appears.

```
Talk    0:15
Call Holding
```

ADDITIONAL INFORMATION

Your CLT-2430 is pre-programmed with 8 call waiting options.

No.	Option	Message
1	Switch/FLASH	Press CID/FLASH to switch callers
2	Ask to Hold	Pre-recorded message asks 2nd caller to hold
3	Tell Busy	Pre-recorded message tells 2nd caller you are busy
4	Take Message	Asks 2nd caller to leave a voice message
5	Answer/Drop first	Disconnects the 1st caller and answers the 2nd
6	Conference	Starts a 3-way conference call with both callers
7	Drop first	Disconnects 1st caller
8	Drop Last	Disconnects 2nd caller

Check with your local telephone company for a full list of options.

Changing the digital security code

The digital security code is an identification code used to connect the handset and the base unit. Normally, setting the code is not necessary.

The first time you charge your handset, the security code is automatically set. (See page E2.)

In the rare situation that you suspect another cordless telephone is using the same security code, you can change the code.

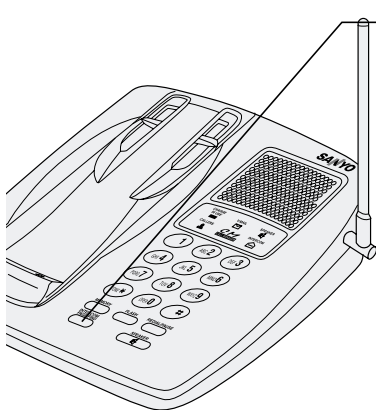

- 1 Remove the handset from the base unit. Press and hold **INTERCOM/PAGE/FIND**.
- 2 While holding **INTERCOM/PAGE/FIND**, return the handset on the base unit. The paging stops. Leave the handset on the base more than 5 seconds. A new security code is set.

Note:

If the handset battery pack is completely discharged or the battery pack is removed, the digital security code will be lost. If this happens, a new security code is set automatically the next time the battery pack is charged.

E48

ADDITIONAL INFORMATION

Installing the belt clip

To attach the belt clip

Insert the belt clip into the holes on each side of the handset. Press down until it clicks.

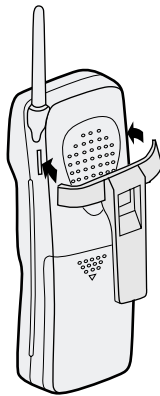

To remove the belt clip

Insert a standard flat head screwdriver into a notch of the belt clip, then remove the belt clip as shown below.

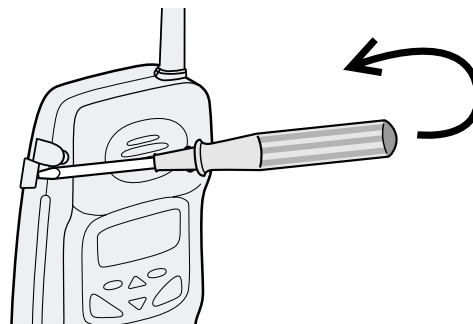

Note:

If you have wall-mounted the base, you must install the belt clip to hold the handset in the proper charging position. Do not hang the handset with the display facing inside.

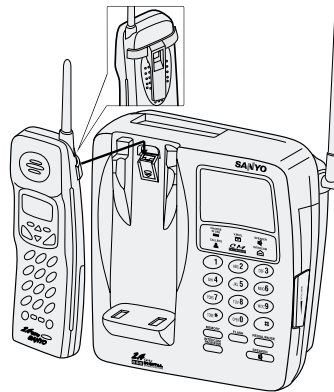

Headset installation

Your phone may be used with an optional headset. To use this feature, simply plug a standard shielded headset with a 2.5-mm plug into the headset jack. Your phone is ready for hands-free conversation.

Note:

Not all headsets are the same. Some headsets may lower volume levels or performance of the phone.

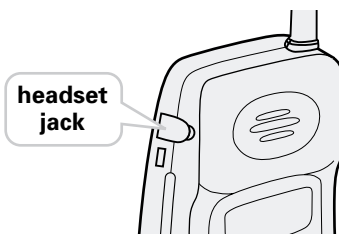

ADDITIONAL INFORMATION

Note on power source

Battery replacement and handling

When the operating time becomes short, even after a battery is recharged, please replace the battery.

With normal usage, your battery should last about one year.

For a replacement battery, please contact your place of purchase or fill out the attached order form and mail it.

RECYCLING NICKEL-CADMIUM BATTERIES



NICKEL-CADMIUM BATTERIES MUST BE DISPOSED OF PROPERLY.

Ni-Cd

Nickel-cadmium cells are used in the battery pack. Please take your used nickel-cadmium battery packs to a store that recycles nickel-cadmium batteries.

Power Failure

During the period that the power is off, you will not be able to make or receive calls with the telephone.

Caution

- Use only the specified battery pack. (See page E9.)
- Do not remove the battery from the handset to charge it.
- Never throw the battery into a fire, disassemble it, or heat it.
- Do not remove or damage the battery casing.

Maintenance

When slightly dirty

Wipe with a soft, dry cloth.

When very dirty

Wipe with a soft cloth that has been dampened with diluted, neutral detergent. Dry with a dry cloth.

When the charging terminals become dirty

Wipe with a dry cloth.

Caution

Do not use paint thinner, benzene, alcohol, or other chemical products. Doing so may discolor the surface of the telephone and damage the finish.

E50

TROUBLESHOOTING

If your phone is not performing to your expectations, please try these simple steps first.

Symptom	Suggestion
The CHARGE/IN USE indicator won't come on when the handset is placed in the base unit.	<ul style="list-style-type: none"> • Make sure the AC adaptor is plugged into the base unit and wall outlet. • Make sure the handset is properly seated in the base unit. • Make sure the charging contacts on the handset and base unit are clean.
Weak and/or scratchy sound	<ul style="list-style-type: none"> • Make sure that the base unit antenna is in a vertical position. • Interference by other electronics equipment such as TVs, computers, microwaves, fluorescent lighting, etc. • Move the handset and/or base unit to a different location away from metal objects or appliances and try again. • Make sure that you are not too far from the base.
Can't make or receive calls.	<ul style="list-style-type: none"> • Check both ends of the base unit telephone line cord. • Make sure the AC adaptor is plugged into the base unit and wall outlet. • Disconnect the AC adaptor for a few minutes, then reconnect it. • Reset the digital security code (See page E48). • Make sure TALK/END is pressed.
The handset doesn't ring or receive a page.	<ul style="list-style-type: none"> • The battery pack may be weak. Charge the battery on the base unit for more than 15 hours. If the handset still does not work, you may need to replace the battery. • The handset may be too far away from the base unit. • Place the base unit away from appliances or metal objects. • Reset the digital security code (See page E48).
The Caller ID does not display.	<ul style="list-style-type: none"> • The call was answered before the second ring. • The call was placed through a switchboard. • Call your local telephone company to verify your Caller ID service is current.

TECHNICAL INFORMATION

REN Number:

The Ringer Equivalence Number (REN) assigned to each terminal device provides an indication of the maximum number of terminals allowed to be connected to a telephone interface. The REN number of this unit is located on the bottom of the base unit. The termination on an interface may consist of any combination of devices subject only to the requirement that the sum of the Ringer Equivalence Numbers of all the devices does not exceed 5.

CAUTION

This Product is intended for use in CANADA only. Sale or use in other countries may violate local laws.

Cordless telephones use radio frequencies to allow mobility. This affects the performance of your unit.

1. NOISE

Electrical pulse noise is present in most homes at one time or another. This is most intense during electrical storms. Certain kinds of electrical equipment, such as light dimmers, fluorescent bulbs, motors, fans, etc., also generate pulse noise.

Because radio frequencies are susceptible to this, you may on occasion hear pulse noise through the handset. This is usually only a minor annoyance and should not be interpreted as a defect of the unit.

2. RANGE

Because radio frequencies are used, the location of the base station can affect the operating range of the unit. Try several locations and choose the one that gives the clearest signal to the handset. (Turning in a circle while holding the handset may also increase the operating range.)

3. INTERFERENCE

Electronic circuits activate a relay to connect the unit to your telephone line. These electronic circuits operate in the radio frequency spectrum. While several protection circuits are used to prevent unwanted signals, there may be periods when these unwanted signals enter the base station. You may hear click or hear the relay activate when you are not using the cordless handset. If this occurs frequently, you can minimize or eliminate the problem by lowering the height of the base station or relocating the base station. It may also be helpful to change the operating channel and/or the security code setting.

Operation is subject to the following two conditions: (1) this device may not cause interference, and (2) this device must accept any interference, including interference that may cause undesired operation of the device.

NOTICE:

Privacy of communications may not be ensured when using this telephone. Other devices, including other cordless telephone telephones, may interfere with the operation of this cordless telephone or cause noise during operation. Units without coded access may be accessed by other radio communication systems. Cordless telephones must not cause interference to any licensed radio service.

The Industry Canada Label identifies certified equipment. This certification means that the equipment meets certain telecommunications network protective, operational and safety requirements. The ministry does not guarantee that the equipment will operate to the user's satisfaction.

Before installing this equipment, users should ensure that it is permissible to be connected to the facilities of the local telecommunications company. The equipment must also be installed using an acceptable method of construction.

In some cases, the company's inside wiring associated with single-line individual service may be extended by means of a certified connector assembly (telephone extension cord). The customer should be aware that compliance with the above conditions may not prevent degradation of service in some situations.

Repairs to certified equipment should be made by an authorized Canadian maintenance facility designated by the supplier. Any repairs or alterations made by the user to this equipment, or equipment malfunctions, may give the telecommunications company cause to request that the user disconnect the equipment.

The user should ensure for his own protection that the electrical ground connections of the power utility, telephone lines and internal metallic water pipe system, if present, are connected together. This precaution may be particularly important in rural areas.

CAUTION

Users should not attempt to make such connections themselves, but should contact the appropriate electrical inspection authority, or electrician, as appropriate.

The exclamation point within an equilateral triangle is intended to alert the user to the presence of important operating and maintenance (servicing) instructions in the literature accompanying the product.

This symbol on the product is used to identify the following important information. Use only with specified SANYO power adaptor.

E52

THE SANYO COMFORT WARRANTY

WARRANTY APPLICATION

Sanyo Communications products purchased new, unused in Canada through a Sanyo Authorized Dealer are warranted against manufacturing defects in materials and workmanship for ONE YEAR covering parts and labour, from the date of purchase by the original retail purchaser. This warranty only applies in favour of the original retail purchaser of the warranted product.

SANYO CANADA INC.'S RESPONSIBILITY

During the warranty period, SANYO Canada Inc. will repair, or at our option, replace a Communications product which shows evidence of a manufacturing defect in materials or workmanship. Replacement PARTS are warranted for the remaining portion of the warranty period.

WHAT IS NOT COVERED

- (a) Communications products purchased outside Canada.
- (b) Communications products purchased in a used condition.
- (c) Communications products purchased from non Sanyo-authorized dealer.
- (d) Communications products not intended for Canadian usage or products without appropriate Canadian regulatory approvals.
- (e) Problems due to product set-up and installation.
- (f) Adjustments that are outlined in the Operating Manual.
- (g) Accessory items including antenna, and batteries.
- (h) Damage in or due to transportation.
- (i) Damage due to improper maintenance, accident, abuse, misuse or negligence.
- (j) Damage caused by lightning and power surges.

ORIGINAL RETAIL PURCHASER'S RESPONSIBILITY

You, the original retail purchaser, must present your original, dated bill-of-sale together with this warranty to SANYO Canada Inc. or to an authorized Sanyo Service Depot when you make a claim under this warranty.

You, the original retail purchaser, are responsible for any costs of TRANSPORTING the product to and from SANYO Canada Inc. or an authorized Sanyo Service Depot. You also are responsible for the cost of any MAINTENANCE necessary in respect of the product.

WARRANTY BECOMES VOID

This warranty becomes void if the product's serial numbers are altered or removed or if any repair to the product is made other than by SANYO Canada Inc. or by an authorized Sanyo Service Depot.

LIMITATIONS

- (a) SANYO Canada Inc. reserves the right to change or improve the design of the model of the product warranted hereunder without incurring any obligation to make any modifications to or to install any improvement in or on the product.
- (b) In no event shall SANYO Canada Inc. or any of its Authorized Dealers be liable for special or consequential damage arising from the use of this product.

STATUTORY WARRANTIES

The above provisions do not preclude the operation of any applicable provincial statute which in certain circumstances may not allow some of the limitations and exclusions described in this Warranty. Where any terms of this Warranty are prohibited by such a statute, they shall be deemed null and void but the remainder of this warranty shall remain in effect.

HOW TO OBTAIN WARRANTY SERVICE

Please contact the Sanyo Authorized Dealer from whom the product was purchased, or contact us directly at:

SANYO Canada Inc.
300 Applewood Cres.
Concord, Ont. L4K 5C7
(905) 760-9944
1-800-263-2244

E53



At Sanyo, fulfilling the needs of our customers is a priority. That's why we created our Sanyo On Site (**SOS**) customer service program that guarantees satisfaction. We're so confident about the quality of our products that we're expanding our warranty to include the following exceptional, new level of service.

SOS guarantees you:

Nationwide Customer Support

SOS is there to help you. Our friendly and knowledgeable product specialists will quickly answer your questions about setup and use of Sanyo telephone products. Simply call toll free from anywhere in Canada to connect to our no-charge, **SOS** support and service network.

1-800-263-2244 between 10:00 AM – 7:00 PM EST

Stay-At-Home Convenience

It's a nuisance making another trip to the store when you're stuck. Now with **SOS**, all that's necessary is a quick call from your home for product assistance or exchange. **SOS** – it's the ultimate in convenience.

Hassle-Free Exchange

Should your Sanyo telephone/telephone with answering system require servicing during the warranty period, **SOS** will have a free replacement unit at your door within 48 hours.* For security reasons, you will be asked to give us your credit card number (VISA or MasterCard).

Guaranteed Quality

All SOS replacement sets are checked and serviced by factory-authorized technicians before being sent out. **SOS** means you never have to worry.

***With SOS,
we've got you
covered!***

E54 * Two business days required

The SANYO logo is rendered in a bold, black, sans-serif font. The letters 'A', 'N', and 'Y' are stylized with multiple parallel vertical lines passing through them, creating a sense of depth and movement.

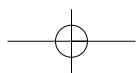
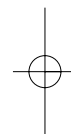
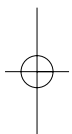



Covered under one or more of the following U.S. patents:

4,511,761 4,523,058 4,595,795 4,797,916 5,381,460
5,426,690 5,434,905 5,491,745 5,533,010 5,574,727
5,650,790 5,660,269 5,661,780 5,663,981 5,671,248
5,717,312 5,754,407 5,768,345 5,787,356 5,838,721

**2000 SANYO All rights reserved
UCZZ01682DZ**

Printed in China

Free Manuals Download Website

<http://myh66.com>

<http://usermanuals.us>

<http://www.somanuals.com>

<http://www.4manuals.cc>

<http://www.manual-lib.com>

<http://www.404manual.com>

<http://www.luxmanual.com>

<http://aubethermostatmanual.com>

Golf course search by state

<http://golfingnear.com>

Email search by domain

<http://emailbydomain.com>

Auto manuals search

<http://auto.somanuals.com>

TV manuals search

<http://tv.somanuals.com>