

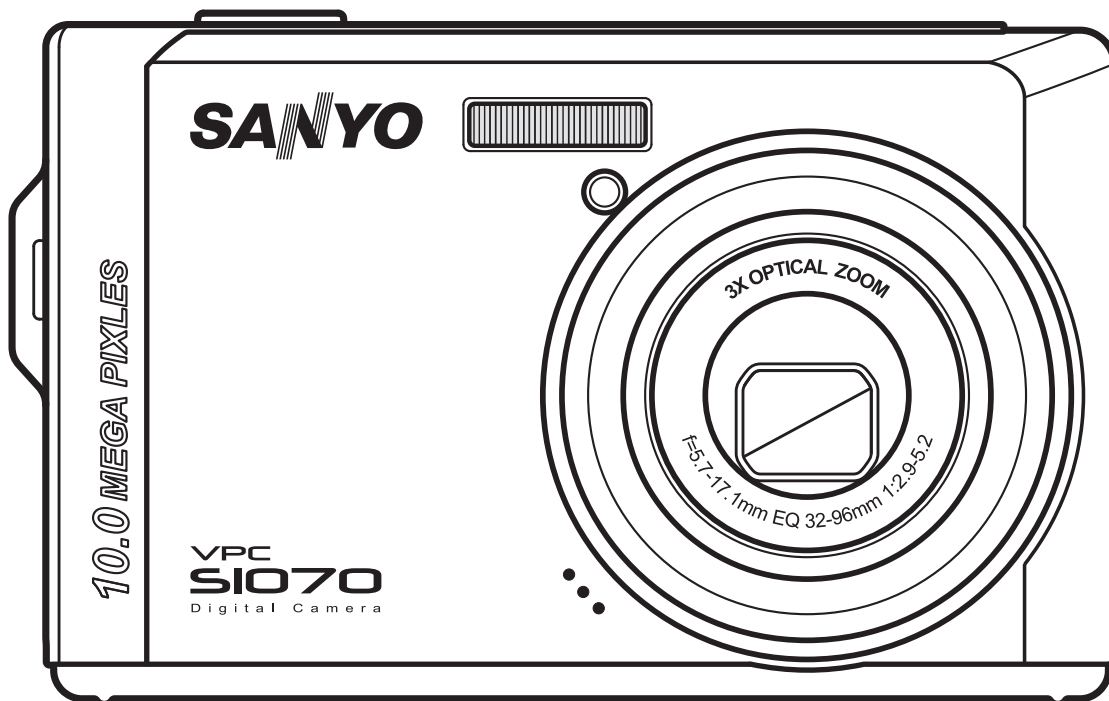
SANYO

INSTRUCTION MANUAL

VPC-S1070

Digital Camera

10 Mega Pixels



Preface

About this Manual

This manual is designed to assist you in using your new digital camera. All information presented is as accurate as possible but is subject to change without notice.

Copyright

This manual contains proprietary information protected by copyright. All rights are reserved. No part of this manual may be reproduced by any mechanical, electronic or other means, in any form, without prior written permission of the manufacturer.

© Copyright 2008

Federal Communications Commission (FCC) Compliance

This equipment has been tested and found to comply with the limits for a Class B digital device, pursuant to Part 15 of the FCC Rules. These limits are designed to provide reasonable protection against harmful interference in a residential installation. This equipment generates, uses, and can radiate radio frequency energy and, if not installed and used in accordance with the instructions, may cause harmful interference to radio communications. However, there is no guarantee that interference will not occur in a particular installation. If this equipment does cause harmful interference to radio or television reception, which can be determined by turning the equipment off and on, the user is encouraged to try to correct the interference by one or more of the following measures:

- Reorient or relocate the receiving antenna.
- Increase the distance between the equipment and the receiver.
- Connect the equipment to an outlet on a circuit different from that to which the receiver is connected.
- Consult the dealer or an experienced radio/TV technician for help.

Warning: A shielded-type power cord is required in order to meet FCC emission limits and to prevent interference to radio and television reception. Use only shielded cable to connect I/O devices to this equipment. Any changes or modifications not expressly approved by the manufacturer may void your warranty and service agreement.

Declaration of Conformity

This device complies with Part 15 of the FCC rules. Operation is subject to the following conditions:

- This device may not cause harmful interference.
- This device must accept any interference received, including interference that may cause undersired operation.

Trademark Recognition

Windows XP/Vista are registered trademarks of Microsoft Corporation in the United States and/or other countries. Windows is an abbreviated term referring to the Microsoft Windows Operation System. Adobe is a trademark of Adobe Corporation. ArcSoft is the trademark of ArcSoft System, Inc. All other companies or product names are trademarks or registered trademarks of their respective companies.

Safety and Handling Precautions

Camera Information

- Do not take apart or attempt to service the camera yourself.
- Do not expose the camera to moisture, or extreme temperatures.
- Allow the camera to warm up when moving from cold to warm temperatures.
- Do not touch the camera lens.
- Do not expose the lens to direct sunlight for extended periods.
- Do not use abrasive chemicals, cleaning solvents or strong detergents to clean the product. Wipe the product with a slightly damp soft cloth.

Battery Information

- Turn off the camera before installing or removing the battery.
- Use only the type of battery. Using other types of battery may damage the equipment and invalidate the warranty.
- Inserting the battery upside down can cause damage to the product and possibly start a fire.
- Download all pictures and remove the battery from the camera if you are going to store the camera for long periods.

Safety Instructions

Read and understand all **Warnings** and **Cautions** before using this product.

WARNING

Do not disassemble, change or repair the camera.

This might cause fire or electric shock. For repair or internal inspection, ask the store of purchase.



Do not use the camera in areas near water.

This might cause fire or electric shock. Take special care during rain, snow, on the beach, or near the shore.



Do not place the camera on inclined or unstable surfaces.

This might cause the camera to fall or tilt over, causing injury.



Keep the battery out of the reach of children.

Swallowing battery might cause poisoning. If the battery is accidentally swallowed, immediately consult a physician.



Do not use the camera while you are walking, driving or riding a vehicle.

This might cause you to fall over or result in traffic accident.



CAUTION

Insert the battery paying careful attention to the polarity (+ or -) of the terminals.

Inserting the battery with its polarities inverted might cause fire and injury, or damage to the surrounding areas due to the battery rupturing or leaking.



Do not fire the flash close to anyone's eyes.

This might cause damage to the person's eyesight.



Do not subject the LCD monitor to impact.

This might damage the glass on the screen or cause the internal fluid to leak. If the internal fluid enters your eyes or comes into contact with your body or clothes, rinse with fresh water.

If the internal fluid has entered your eyes, consult a physician to receive treatment.



A camera is a precision instrument. Do not drop it, strike it or use excessive force when handling the camera.

This might cause damage to the camera.



Do not use the camera in humid, steamy, smoky, or dusty places.

This might cause fire or electric shock.



Do not remove the battery immediately after long period of continuous use.

The battery becomes hot during use. Touching a hot battery might cause burns.



Do not wrap the camera or place it in cloth or blankets.

This might cause heat to build up and deform the case, resulting in fire. Use the camera in a well-ventilated place.



Do not leave the camera in places where the temperature may rise significantly, such as inside a car.

This might adversely affect the case or the parts inside, resulting in fire.



Before you move the camera, disconnect cords and cables.

Failure to do this might damage cords and cables, resulting in fire and electric shock.



Warning:

TO PREVENT THE RISK OF FIRE OR ELECTRIC SHOCK, DO NOT EXPOSE THIS APPLIANCE TO RAIN OR MOISTURE

FOR AMERICAN USERS

The following advisory is included in accordance with the laws of the State of California (USA):

WARNING:

This product contains chemicals, including lead, known to the States of California to cause cancer, birth defects or other reproductive harm. ***Wash hands after handling.***

Safety Instructions

- This equipment has been tested and found to comply with the limits for a Class B digital device, pursuant to Part 15 of the FCC Rules. These limits are designated to provide reasonable protection against harmful interference in a residential installation. This equipment generates, uses and can radiate radio frequency energy and, if not installed and used in accordance with instructions, may cause harmful interference to radio communications. However, there is no guarantee that interference will not occur in a particular installation. If this equipment does cause harmful interference to radio or television reception, which can be determined by turning the equipment off and on, the user is encouraged to try to correct the interference by one or more of the following measures:
 - * Reorient or relocate the receiving antenna.
 - * Increase the separation between the equipment and receiver.
 - * Connect the equipment into an outlet on a circuit different from that to which the receiver is connected.
 - * Consult the dealer or an experienced radio/TV technician for help.
- Changes or modifications not expressly approved by the party responsible for compliance could void the user's authority to operate the equipment.

FOR CANADIAN USERS

This Class B digital apparatus complies with Canadian ICES-003

FOR EU USERS



This symbol mark and recycling systems described below apply to EU countries and do not apply to countries in other areas of the world.

Your SANYO product is designed and manufactured with high quality materials and components which can be recycled and/or reused.

The symbol mark means that electrical and electronic equipment, batteries and accumulators, at their end-of-life, should be disposed of separately from your household waste.

Note:

If a chemical symbol is printed beneath the symbol mark, this chemical symbol means that the battery or accumulator contains a heavy metal at a certain concentration.

This will be indicated as follows: Hg: mercury. Cd: cadmium. Pb: lead

In the European Union there are separate collection systems for used electrical and electronic equipment, batteries and accumulators.

Please, dispose of them correctly at your local community waste collection/recycling centre.

Please, help us to conserve the environment we live in!

Manufacturer and Address

SANYO Electric Co., Ltd.

5-5, Keihan-hondori, 2-chome,
Moriguchi City, Osaka, Japan

Authorized Representative and Address

SANYO FISHER Sales (Europe) GmbH

Stahlgruberring 4, D-81829 Munich, Germany

Symbols used in this manual



Points giving some extended instructions or special points to pay attention to.

You may find the answers to questions or problems concerning camera operation in the sections "Troubleshooting".

FCC Information



Tested To Comply With FCC Standards
FOR HOME OR OFFICE USE

Declaration of Conformity

Model number: VPC-S1070

Trade Name: SANYO

Responsible party: SANYO FISHER COMPANY

Address: 21605 Plummer Street
Chatsworth, California 91311

Telephone No.: (818) 998-7322

This device complies with Part 15 of the FCC Rules. Operation is subject to the following two conditions:

- (1) this device may not cause harmful interference, and
- (2) this device must accept any interference received, including interference that may cause undesired operation.

Canadian ICES-003 Information

This class B digital apparatus complies with Canadian ICES-003.

TRADEMARK INFORMATION

- Microsoft® and Windows® are U.S. registered trademarks of Microsoft Corporation.
- Pentium® is a registered trademark of Intel Corporation.
- Macintosh® is a trademark of Apple Computer, Inc.
- SD™ is a trademark.
- SDHC™ is a trademark. 
- Other names and products may be trademarks or registered trademarks of their respective owners.

READ THIS FIRST

Notice:

- Product design and specifications are subject to change without notice. This includes primary product specifications, software, software drivers, and user's manual. This User Manual is a general reference guide for the product.
- The product and accessories that come with your camera may be different from those described in this manual. This is due to the fact that different retailers often specify slightly different product inclusions and accessories to suit their market requirements, customer demographics, and geographical preferences. Products very often vary between retailers especially with accessories such as batteries, memory cards, cables, pouches, and language support. Occasionally a retailer will specify a unique product color, appearance, and internal memory capacity. Contact your dealer for precise product definition and included accessories.
- The illustrations in this manual are for the purpose of explanation and may differ from the actual design of your camera.
- The manufacturer assumes no liability for any errors or discrepancies in this user manual.

Table of Contents

Preface	i
About this Manual	i
Copyright	i
Federal Communications Commission (FCC) Compliance	i
Declaration of Conformity	i
Trademark Recognition	ii
Safety and Handling Precautions	ii
Camera Information	ii
Battery Information	ii
Safety Instructions	iii
WARNING	iii
CAUTION	iv
FOR AMERICAN USERS	iv
FOR CANADIAN USERS	v
FOR EU USERS	vi
Symbols used in this manual	vi
FCC Information	vii
Declaration of Conformity	vii
Canadian ICES-003 Information	vii
TRADEMARK INFORMATION	viii
READ THIS FIRST	viii
Introduction	1
System Requirements	1
Package Contents	1
Main Features	1
Camera Views	2
Front View	2
Back View	2
Top View	2
Bottom View	3
Left / Right View	3
LED Indicators	3
Camera Buttons	4
Navigation Buttons	4
The Scene Button	7
Function Buttons	8
LCD screen	9
Capture/Video Mode Display	9
Camera Setup	14
Attaching the Wrist Strap	14
Inserting the Battery	14
Inserting an SD/MMC Memory Card	15

Turning On	15
First Time Use	16
Getting Started	17
Taking your First Photo	17
Anti-Shake Function	17
Using Macro Mode	17
Setting the Flash Mode	17
Using the Zoom in/out Function	18
Using the Self-timer and Burst Photography	18
Using the AEB (Auto Exposure Bracketing) Function	19
Setting the Scene Mode	20
Face Detection AF/AE Function	21
Recording your First Video	21
Recording Voice Memos	21
Capture Settings	23
The Capture Menu	23
Image Resolution	23
Image Quality	24
Focus Zone	24
EV Compensation	24
AEB	25
M-Burst Interval	25
White Balance	25
ISO Speed	26
AE Metering	26
Color	26
Sharpness	27
Saturation	27
Contrast	27
Setup	27
Video Capture Menu	28
Video Resolution	28
White Balance	28
Color	28
Saturation	28
Contrast	28
Setup	28
Photo & Video Playback	29
Playback Mode Display	29
Viewing Photos/Videos on the LCD Screen	31
Viewing M-Burst Photos	31
Listening to Voice Memo	32
Viewing Photos/Videos on your TV	32

Zooming In/Out During Playback	33
Deleting Photos/Videos	33
Using the Playback Menu	33
DPOF	34
Slideshow	35
Resize	35
Rotate	36
Protect	36
Move	37
Back to AUTO memory mode:	37
Transferring Photos/Videos to your PC	38
Camera Settings	39
The Setup Menu	39
LCD Brightness	39
File Number	39
Digital Zoom	40
Quick View	40
Continuous AF	40
Camera Sound	40
Auto LCD Off	41
Auto Power Off	41
Video Out	41
USB Mode	41
Date Stamp	42
Date and Time	42
Language	42
Image Storage	43
Format	43
Reset	43
Voice Memo	44
About	44
PictBridge Print (PTP)	44
Image Storage	45
This Image	46
Index Print	47
DPOF Image	47
All Images	48
Specifications	49
Troubleshooting	52

Introduction

Congratulations on the purchase of your new digital camera. This manual provides step-by-step instructions on how to use your camera, and is intended for your reference only.

System Requirements

In order to get the most out of your camera, your computer must meet the following system requirements:

- OS: Windows XP/Vista
- Memory: 128MB or above
- HDD space: 40 MB or above
- USB port

Package Contents

Check the contents of your camera package. It should contain:

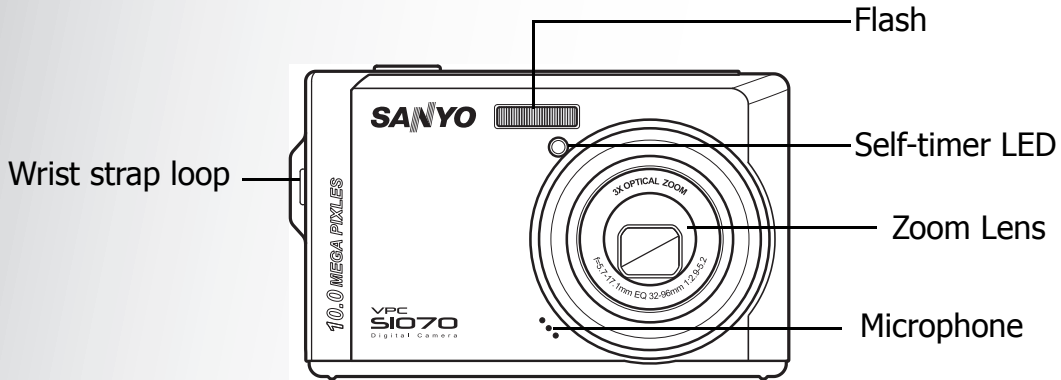
- Digital camera
- USB/AV 3-in-1 cable
- Wrist strap
- Two AA batteries (Alkaline)
- Camera pouch
- Quick start guide for all regions
- Bundled CD-ROM (Application Software and User's Manual for all regions)

Main Features

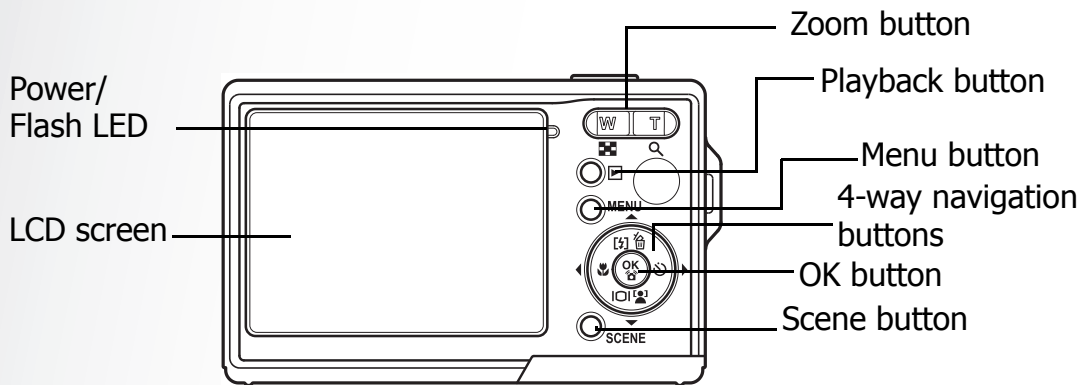
- 10.0 mega pixels resolution
- 15x zoom (Up to 3x optical zoom and 5x digital zoom)
- 1/2.3x inch CCD image sensor
- 2.4 inch GPT TFT LCD monitor
- Approx. 9.5MB internal flash memory, support SD memory card from 32MB to 16GB.
- Sleek and slim design
- Easy-to-use button interface
- PictBridge compatibility
- Slideshow feature to review your pictures and movies
- A/V output to view your pictures and movies on your TV
- USB port to transfer photos and movies to your PC

Camera Views

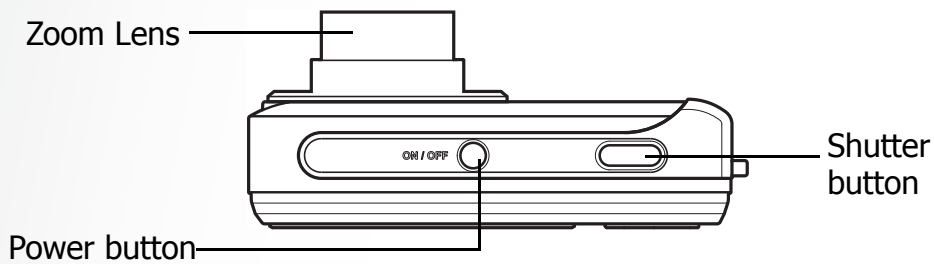
Front View



Back View

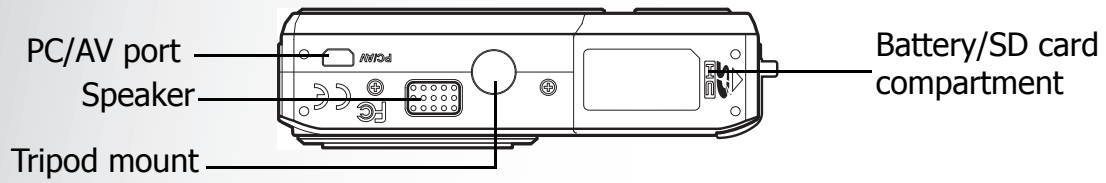


Top View



Camera Views

Bottom View



Left / Right View







LED Indicators




LED	LED Status	Camera Status
Power/ Flash LED	Off	Power Off.
	Green (steady)	Ready to take picture.
	Green (blinking)	Camera busy
Self-timer LED	Off	Self-timer off.
	Red (blinking) (10 sec)	Timer count down, flash after 10 seconds.
	Red (blinking) (2 sec)	Timer count down, flash after 2 seconds.

Camera Buttons



Navigation Buttons

The 4-way navigation buttons and the **OK** button allow you to access the various options available from the On Screen Display (OSD) menu. You can configure a wide range of settings to ensure maximum results from your photos and videos.

Icon	Button	Function
OK/ 	OK/Anti-shake	<ol style="list-style-type: none"> 1. Confirm a selection when using the OSD menus 2. In Capture mode: <ul style="list-style-type: none"> • Press to enable/disable the Anti-Shake in Auto mode • Press to enable AF area selection using 4-way navigation buttons (except Auto/ Video/ Landscape/ Night Landscape/ Fireworks) 3. In Playback mode: <ul style="list-style-type: none"> • Press to start and pause the video playback • Press to stop the voice memo playback 4. In USB mode: <ul style="list-style-type: none"> • MSDC: N/A • PTP: Press to confirm the selection
	Up/Flash/Delete	<ol style="list-style-type: none"> 1. Move up in the OSD menus 2. In Capture mode: <ul style="list-style-type: none"> • Scroll through the flash mode options (Auto, Off, Fill and Anti Red-eye.) • Press to pan up in AF area selection • Press to delete in QUICK VIEW (QV) "ON" at SETUP () mode during  mark appears on LCD. 3. In Playback mode: <ul style="list-style-type: none"> • Press to pan up in zoom in mode • Press to move up in the thumbnail display • Press to delete images 4. In USB mode: <ul style="list-style-type: none"> • MSDC: N/A • PTP: Press to scroll up through a menu

















Icon	Button	Function
	Right/Self-timer/ Burst mode	<ol style="list-style-type: none"> 1. Move right in the OSD menus 2. In Capture mode: <ul style="list-style-type: none"> • Press to scroll through the Self-timer/Burst/ Multi-Burst mode • Press to pan right in AF area selection 3. In Video mode: <ul style="list-style-type: none"> • Press to scroll through the Self-timer options 4. In Playback mode: <ul style="list-style-type: none"> • Press to pan right in zoom in mode • Press to navigate to next image in single up • Press to move right in the thumbnail display • Press to fast forward video playback during Pause  mode 5. In USB mode: <ul style="list-style-type: none"> • MSDC: N/A • PTP: Press to select the next image in This Image submenu
	Down/Screen/ Face Detection	<ol style="list-style-type: none"> 1. Move down in the OSD menus 2. In Capture mode: <ul style="list-style-type: none"> • Once press to exit histogram,twice press to enter face detection, press again to turn off extra icons on the LCD screen,then press to turn all icons back on the LCD screen • Press to pan down in AF area selection 3. In Video mode: <ul style="list-style-type: none"> • Press to turn off extra icons on the LCD screen, press again to turn all icons back on the LCD screen 4. In Playback mode: <ul style="list-style-type: none"> • Press to pan down in zoom in mode • Press to move down in the thumbnail display • Press to show the file information 5. In USB mode: <ul style="list-style-type: none"> • MSDC: N/A • PTP: Press to scroll down through a menu

6 Introduction

Icon	Button	Function
	Left/Macro	<ol style="list-style-type: none">1. Move left in the OSD menus2. Go up to the previous level in the OSD menus3. In Capture mode:<ul style="list-style-type: none">• Press to enable Macro mode. Macro icon displays on the LCD screen• Press to pan left in AF area selection4. In Playback mode:<ul style="list-style-type: none">• Press to pan left in zoom in mode• Press to navigate to previous image in single down• Press to move left in the thumbnail display• Press to fast rewind video playback during Pause  mode5. In USB mode:<ul style="list-style-type: none">• MSDC: N/A• PTP: Press to select the previous image in This Image submenu

The Scene Button

The camera is equipped with a convenient **SCENE** button that takes you to the **Scene Menu** where you can scroll between different modes and choose different scene options. Use the **4-way** navigation buttons to scroll and use the **OK** button to select. Use the **SCENE** button to:

Mode Type	Icon	Function
Auto		Scroll to Auto mode.
P-Mode (Program Mode)		Scroll to Program mode.
Video		Scroll to Video mode.
Sport		Scroll to Sport mode.
Landscape		Scroll to Landscape mode.
Night Landscape		Scroll to Night Landscape mode.
Portrait		Scroll to Portrait mode.
Night Portrait		Scroll to Night Portrait mode.
Museum		Scroll to Museum mode.
Snow		Scroll to Snow mode.
Sunset		Scroll to Sunset mode.
Fireworks		Scroll to Fireworks mode.
Beach		Scroll to Beach mode.
Party		Scroll to Party mode.
Foliage		Scroll to Foliage mode.
Aquarium		Scroll to Aquarium mode.

8 Introduction

Kids & Pets



Scroll to **Kids & Pets** mode.

Copy



Scroll to **Copy** mode.

Backlight



Scroll to **Backlight** mode.



Function Buttons

Icon	Button	Function
MENU	Menu	Press to display the Menu options
	Playback	Press to review photos/videos clips saved in the internal memory or on the memory card
T / Q	Zoom in	In Capture mode: <ul style="list-style-type: none">• Press to zoom in on subject to be taken In Playback mode: <ul style="list-style-type: none">• Press to zoom in on saved photos
W /	Zoom out	In Capture mode: <ul style="list-style-type: none">• Press to zoom out from the subject to be taken In Playback mode: <ul style="list-style-type: none">• Press to zoom out of saved photos• Press to view thumbnails of all current saved media

Camera Buttons

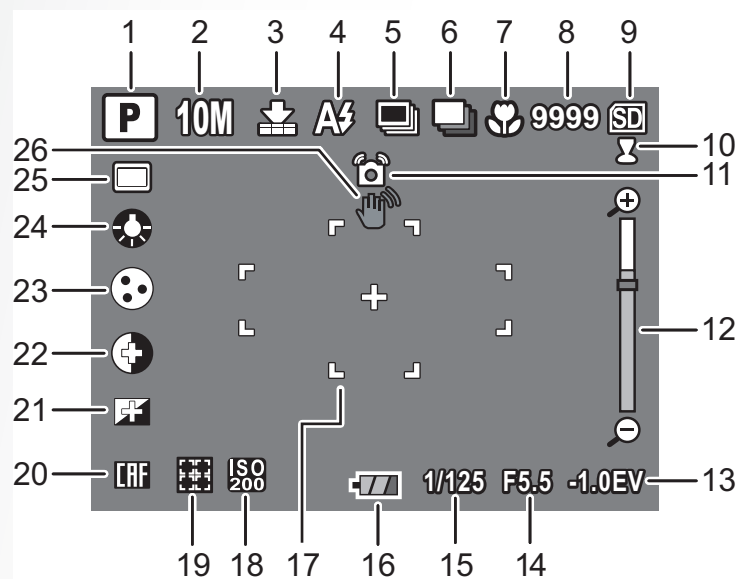
LCD screen

The high resolution 2.4" TFT LCD screen shows all important information regarding camera settings as well as the visual image for your photo or video.

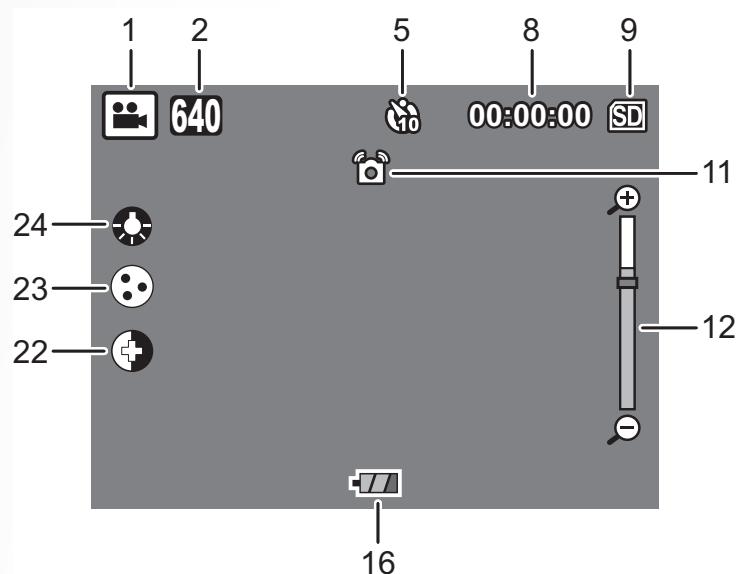
Use the **SCENE** button to switch between screen modes. Press the **Down**  / **Screen SCN/ Face Detection**  button to switch among a full display with histogram and without histogram, Face detection and simple display (only mode icon and focus area are shown while other icons are hidden).

Capture/Video Mode Display






















Capture Mode
























Video



10 Introduction
















No.	Name	Scene	Icon
1	Scene indicator	Auto	
		P-Mode	
		Video	
		Sport	
		Landscape	
		Night Landscape	
		Portrait	
		Night Portrait	
		Museum	
		Snow	
		Sunset	
		Fireworks	
		Beach	
		Party	
		Foliage	
		Aquarium	
		Kids & Pets	
		Copy	
		Backlight	
2	Image Resolution	10M	
		8M	

LCD screen



















		6M		
		5M		
		3M		
		1M		
		VGA		
3	Image Quality	Best		
		Better		
		Good		
4	Flash	Auto Flash		
		Flash Off		
		Fill Flash		
		Anti Red-eye		
5	Self-timer/ Burst mode	Self Timer	10 Seconds	
			2 Seconds	
		Burst Mode		
		M-Burst		
6	AEB	AEB		OFF
		Bracket		+/- 0.3 EV
		Exit		-
7	Macro indicator	Macro Mode		
8	Image Counter	Capture Mode	Quantity	9999
		Video Mode	Time	00:00:00
9	Memory Interface	SD Card		
		Internal Memory		
10	Date Stamp	-		
11	Anti-Shake	-		

LCD screen

12 Introduction

12	Zoom Bar	-		
13	EV Compensation	-		-2.0EV~+2.0EV (No icon for 0.0EV)
14	Aperture Value	-		Wide: F2.9 - F5.5/ Tele: F5.2 - F10.0 (Automatic)
15	Shutter Speed	-		Approx. 1/2000 sec. ~ approx. 4 sec. (Automatic)
16	Battery Indicator	Battery Full		
		Battery Low		
		Battery Insufficient		 (Blink)
17	AF Frame	-		-
18	ISO Speed	Auto		
		ISO 100		
		ISO 200		
		ISO 400		
		ISO 800		
		ISO 1000		
		ISO 1600		
19	Focus Zone	Multi-Zone		
		Center		
		Selected Area		
20	Continuous AF	-		

LCD screen

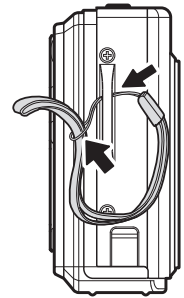
21	Sharpness	High	
		Normal	
		Low	
22	Contrast	High	
		Normal	
		Low	
23	Saturation	High	
		Normal	
		Low	
24	White Balance	Auto	
		Sunny	
		Tungsten	
		Fluorescent	
		Cloudy	
25	AE Metering	Matrix	
		Spot	
		Average	
26	Camera Steady Warning	-	

Camera Setup

Attaching the Wrist Strap

Follow these instructions to attach the wrist strap to your camera to facilitate easy carrying:

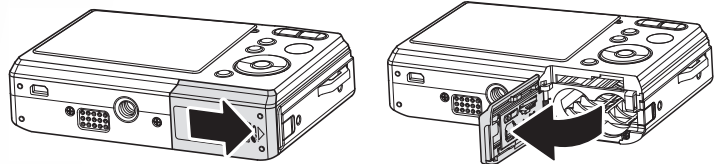
1. Insert the short loop of the strap in the strap eyelet.
2. String the larger loop of the strap through the short loop and pull tight to attach the strap to the camera.



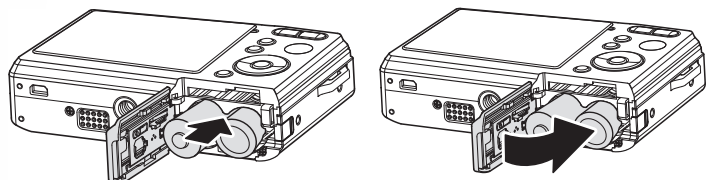
Inserting the Battery

Follow these instructions to insert the two AA batteries into the battery compartment.

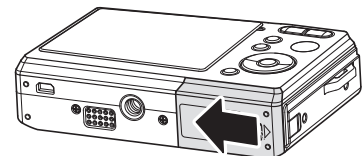
1. Open the battery compartment at the bottom of the camera.



2. Insert the battery into the compartment observing the correct polarity.



3. Close the battery compartment.



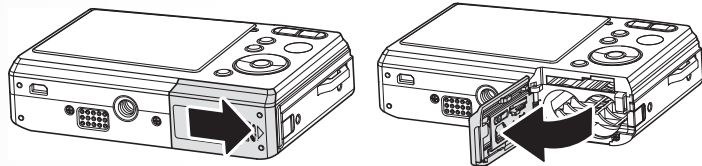
Note: The 2 supplied batteries (Alkaline) can be used. They are not rechargeable. Other new AA Alkaline battery can be used. If you use type AA rechargeable batteries, they first have to be full charged.

Inserting an SD/MMC Memory Card

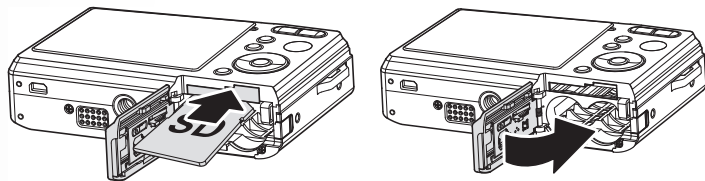
The camera features 9.5 MB internal flash memory but you may also use an optional SD/MMC memory card for additional storage.

Follow these instructions to insert the SD/MMC card.

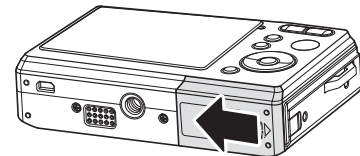
1. Open the battery compartment at the bottom of the camera.



2. Insert the SD/MMC card into the memory card slot as shown. (Label side up)



3. Close the battery compartment.



To remove the SD/MMC card, gently push the card until it pops out. Pull out the card carefully.

Note:

Please don't take in and out the SD card while camera is processing. It will make unexpected error or image damaged.

Turning On

Press and hold the **Power** button to turn on the camera. To turn off the camera, press the **Power** button again.

First Time Use

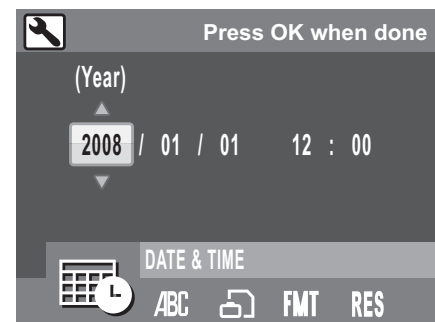
Press the **Power** button as described in “Turning On” on page 15, a welcome screen displays momentarily on the LCD screen.



If the camera is turned on for the first time, the **Language** menu pops up automatically after powering on the camera. Press the **OK** button and select the desired language by **Up/Down** navigation buttons, then press the **OK** button to confirm.



After the desired language is selected, the **Date and Time** menu pops up. Press the **OK** button. Select each field and adjust the value using the navigation buttons. Press the **OK** button to confirm.



Note:

If the Date and Time is reset (when running out the battery and not in use for a long period), the Date and Time setup screen displays automatically.

Getting Started

Now that you are familiar with the layout of your camera, you are ready to start taking photos and movies.

Taking your First Photo



Taking a photo with the camera is very simple.

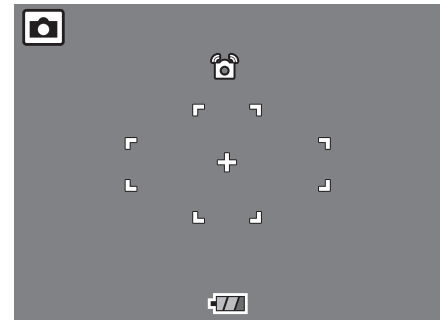
Turn the camera on and press the **SCENE** button to access the **Auto**  mode.

1. Frame the shot on the LCD screen and press the **Shutter** button halfway. The camera automatically adjusts the focus and exposure. The focus bracket turns green when ready.
2. Press fully and hold the **Shutter** button to capture the image.



When a camera steady warning icon  appears, hold the camera as still as possible, as a longer exposure time (more than 1/30 second) is required.

Anti-Shake Function

This function is available in **Auto**  capture mode. Press the **OK** button to enable the Anti-Shake function, and press again to disable it. An **Anti-Shake** icon  displays on the LCD screen when the function is activated.




Using Macro Mode


Macro mode is designed for close-up photography and can capture all detail even when your subject is very close to the camera. Press the **Left/Macro**  navigation button. The Macro icon  displays on the LCD screen.

Setting the Flash Mode

You can choose from four flash modes to suit various lighting conditions.

Press the **Up/Flash/Delete**  navigation button to scroll through the four modes on the LCD screen. The flash setting remains the same for subsequent photos until you change it as described above.

 Auto flash: The flash fires automatically when needed.

 Flash off: The flash is turned off.

 Fill flash: The flash always fires.

18 Getting Started





Anti Red-eye: The flash fires twice so as to reduce the red-eye effect.

Using the Zoom in/out Function

The camera comes equipped with 3x optical zoom and 5x digital zoom that allows you to zoom in on your subject.







To use the zoom:

1. Press the right side of the **Zoom** button **T**  to zoom in on your subject.
2. Press the left side of the **Zoom** button **W**  to zoom out from your subject.

Using the Self-timer and Burst Photography

The camera comes equipped with a self-timer which allows you to take photos after a pre-defined delay. The burst photography feature allows you to take multiple consecutive photos by pressing and holding the **Shutter** button. The multi-burst photography feature allows you to take multiple (16) consecutive VGA photos by pressing the **Shutter** button once.

To set the self-timer/burst mode:

1. Press the **Right/Self-timer/Burst mode**  navigation button to cycle through the self-timer ( or ) and burst photography options ( or ) on the LCD screen.
2. Once you have selected an option, frame and take your shot. In self-timer mode, the icon will flash until the time expires and the photo is taken.
3. After taking a photo, the Self-timer automatically exit. If you want to use these functions for the next photo, press the **Right/Self-timer/Burst mode**  navigation button again to activate the function.

Note:



Burst Mode

Take photos until all free memory space is used.



Multi-Burst Mode

16 photos continuously by 1 press of the Shutter button.

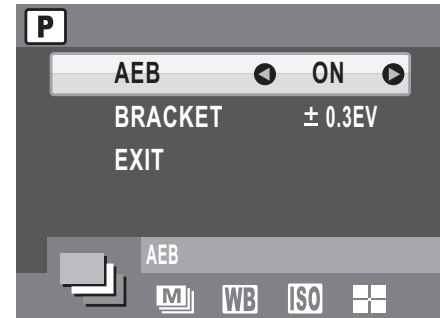
Taking your First Photo

Using the AEB (Auto Exposure Bracketing) Function

When using the **AEB (Auto Exposure Bracketing)** function, the camera automatically takes 3 consecutive photos with different exposures by pressing the **Shutter** button once. For example, when the current EV compensation value is +0.3 EV and the AEB bracket interval value is set to ± 0.3 , the camera takes shots of the same scene with 3 varying levels of exposure: 0 EV, +0.3 EV, and -0.3 EV.

This function is only available in **Auto** and **P-Mode** modes. To set the AEB mode:

1. Press the **MENU** button to display menu options.
2. Press the **Left/Right** navigation buttons to select **AEB** setting and press the **OK** button.
3. Press the **Up/Down** navigation buttons to select from the available options:
 - **AEB**: Select to enable (ON) or disable (OFF) the AEB function.
 - **BRACKET**: Select to set the bracket interval value ranging from ± 0.3 to ± 2.0 EV in 0.3 or 0.4 EV increments.
 - **EXIT**: Select to apply new settings to the camera and return to the setup menu.



Note:

1. When taking AEB shots, hold the camera steadily. For the best result, use the tripod.
2. Flash, Burst, and M-Burst modes are not allowed when the AEB function is enabled.




















Setting the Scene Mode

The camera supports various preset modes for shooting in different environments and conditions. Each setting is configured automatically by the camera.

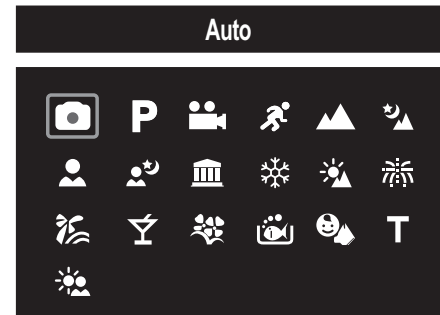
To select scene modes:

Press the **SCENE** button to access **Scene** menu which displays the Scene menu options.

1. Use the **4-way** navigation buttons to scroll through the modes.

- Auto 
- P-Mode 
- Video 
- Sport 
- Landscape 
- Night Landscape 
- Portrait 
- Night Portrait 
- Museum 
- Snow 
- Sunset 
- Fireworks 
- Beach 
- Party 
- Foliage 
- Aquarium 
- Kids & Pets 
- Copy 
- Backlight 

2. Press **OK** to confirm your selection.



Face Detection AF/AE Function

The face (👤) detection functions can be set on and off with each press of the **Down/Screen** [O] navigation button in most capture modes. When the subject's face is detected, the white bracket appears to track faces while the camera or people are moving.

When the **Shutter** button is pressed halfway, the green focus frames appear on the LCD screen. Then the camera automatically adjusts the focus point and exposure to the optimized value. Press the **Shutter** button all the way to take pictures with detected face.



However, when the camera fails to detect your subject's face, a white focus bracket will be displayed according to the selected focus mode.

To disable the face detection function, press the **Down/Screen** [O] navigation button again.

Recording your First Video

You can also record video clips with the camera.

To record a video clip:

1. Turn the camera on and press the **SCENE** button. Use the 4-way navigation buttons to locate **Video** [📹] mode. Press the **OK** button to select.
2. Frame your subject using the LCD screen and press the **Shutter** button to start recording. The self-timer LED is steady on to indicate recording is in progress.
3. Press the **Shutter** button again to stop recording.
4. In playback mode (Press the [▶] button), press the **OK** button to playback the video. Press the **Up/Flash/Delete** [⚡] [🗑️] navigation button to delete the recording if needed.

Recording Voice Memos

The voice memo should be activated (ON) on the VOICE MEMO submenu of SETUP menu at first.

In Capture mode:

You can add a 1-minute voice memo to an image right after it's taken.

1. Hold the **Shutter** button to start recording and release the **Shutter** button to stop recording.
2. While recording, the captured image and the elapsed time are shown on the LCD screen.
3. For the playback, press the [▶] button, and the playback of the voice memo automatically starts.

22 Getting Started

4. Press the **OK** button once for playback again.

In Playback mode:

1. Press the shutter button to start recording and press again to stop recording.
2. While recording, the selected image and the elapsed time are shown on the LCD screen.
3. The playback of the voice memo automatically starts.
4. Press the **OK** button once for playback again.

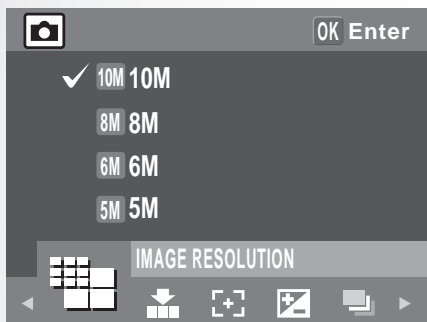
Capture Settings

This section describes the various settings you can modify to get better results when taking photos and video clips.

The Capture Menu

To access the Capture menu:

1. Press the **SCENE** button. Use the 4-way navigation buttons to select the capture mode you need.
2. Press the **MENU** button to display menu options and use the **Left/Right** navigation buttons to select the function you need, then press the **OK** button to enter the selection function.
3. Press the **Up/Down** navigation buttons to highlight an option and press the **OK** button to confirm.



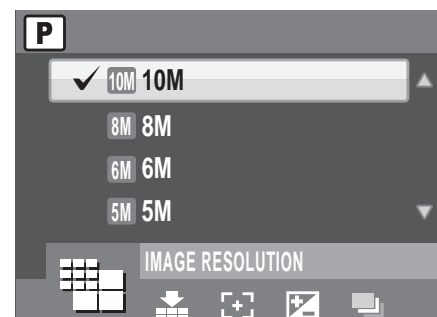
Refer to the following sections for more detailed information about each setting.

Note: All the options in this section may vary according to the different modes.

Image Resolution

The **Image Resolution** setting refers to the size of the image in pixels. Use the **Up/Down** navigation buttons to select from the options. 7 settings for image resolution are available:

- 10M (3648x2736)
- 8M (3264x2448)
- 6M (3072x2304)
- 5M (2592x1944)
- 3M (2048x1536)
- 1M (1024x768)
- VGA (640x480)



24 Capture Settings

Image Quality

The **Image Quality** setting refers to the compression ratio of the JPG. The higher image quality, more memory space is required. Use the **Up/Down** navigation buttons to select from the options. 3 settings for image quality are available:

- Best (default)
- Better
- Good



Focus Zone

Auto Mode

The **Focus Zone** setting allows you to select the number of zones the camera will focus on when taking a photo. Use the **Up/Down** navigation buttons to select from the options and press the **OK** button to enter. 2 settings for focus zone are available:

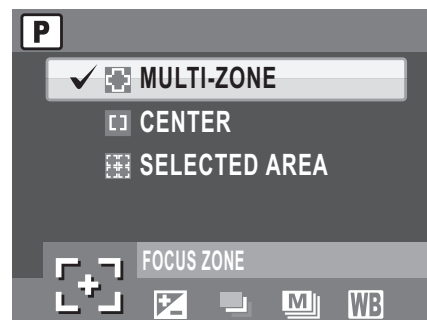
- Multi-Zone (default)
- Center



P-Mode

The **Focus Zone** setting allows you to select the number of zones the camera will focus on when taking a photo. Use the **Up/Down** navigation buttons to select from the options and press the **OK** button to enter. 3 settings for focus zone are available:

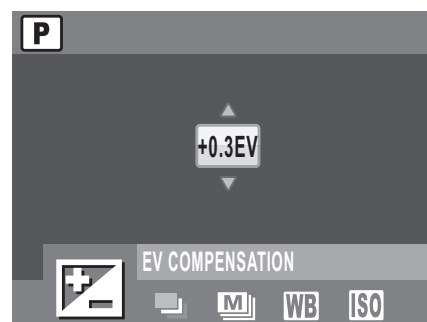
- Multi-Zone (default)
- Center
- Selected Area



EV Compensation

The **EV Compensation** menu allows you to adjust the exposure or amount of light that enters the lens while capturing photos or videos. Use this feature to lighten or darken the image when the brightness between the subject and background is not balanced or when the subject occupies only a small part of the photograph. Use a positive (+) EV compensation for spotlight subjects, especially against dark backgrounds or scenes with low reflectivity, such as green or dark foliage.

Use the **Up/Down** navigation buttons to modify the value. This setting can be modified from -2.0 to +2.0 in a 0.3/0.4 increment/decrement.

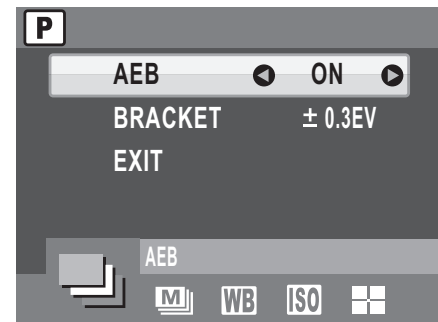


The Capture Menu

AEB

When using the **Auto Exposure Bracketing (AEB)** function, the camera automatically takes 3 consecutive photos with different exposures by pressing the **Shutter** button once. For example, when the current EV compensation value is +0.3 EV and the AEB bracket interval value is set to 0.3, the camera takes shots of the same scene with three varying levels of exposure: 0 EV, +0.3 EV, and 0.7 EV. This function is only available in **Auto** and **P-Mode** modes. To set the AEB mode:

1. Press the **MENU** button to display menu options.
2. Press the **Left/Right** navigation buttons to select **AEB** setting and press the **OK** button.
3. Press the **Up/Down** navigation buttons to select from the available options:
 - AEB: Select to enable or disable the AEB function.
 - Bracket: Select to set the bracket interval value ranging from 0.3 to 0.0 EV in 0.3 or 0.4 EV increments.
 - Exit: Select to apply new settings to the camera and return to the setup menu.



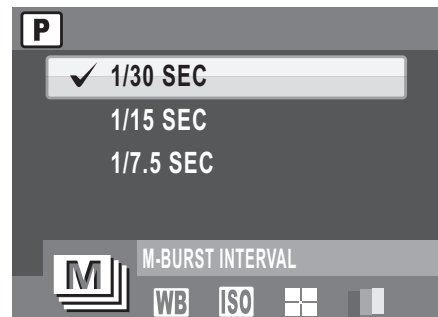
Note:

1. When taking AEB shots, hold the camera steadily. For the best result, use the tripod.
2. Flash, Burst, and M-Burst modes are not allowed when the AEB function is enabled.

M-Burst Interval

The **M-Burst Interval** setting allows you to adjust the burst interval when the multi-burst function is enabled. Use the **Up/Down** navigation buttons to select from the options.

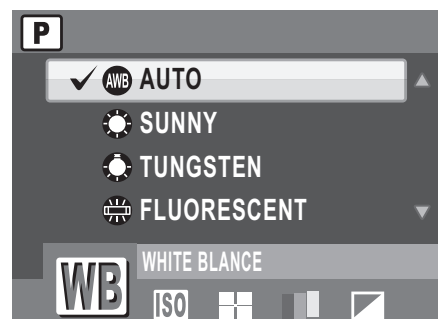
- 1/30 Sec (default)
- 1/15 Sec
- 1/7.5 Sec



White Balance

The **White Balance** setting allows you to adjust the camera setting according to the ambient white light when shooting. White balance represents the degree of coolness of the light. If the light has a yellowish or reddish tinge, it is said to be warm; if it has a bluish tinge, it is said to be cool. You can select the setting and preview it on screen before confirming your choice. Use the **Up/Down** navigation buttons to select from the options. 5 white balance settings are available:

- Auto (default)
- Sunny
- Tungsten
- Fluorescent
- Cloudy

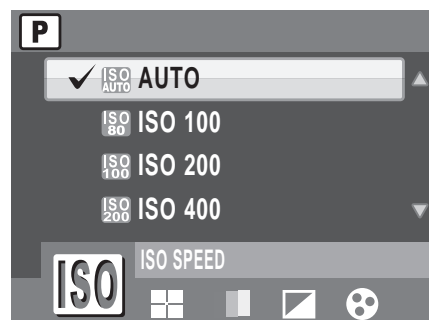


26 Capture Settings

ISO Speed

The **ISO Speed** setting allows you to adjust the CCD light-sensitivity. Use the **Up/Down** navigation buttons to select from the options. 7 ISO settings are available:

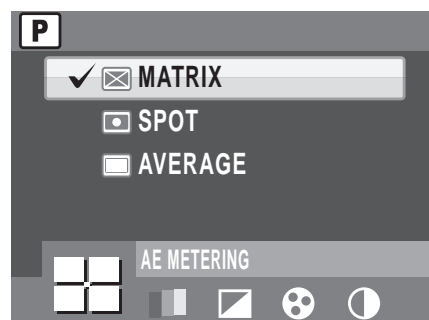
- Auto (default)
- ISO 100: For outdoor photography in bright sunlight.
- ISO 200: For outdoor or indoor photography in bright light.
- ISO 400: For indoor photography or low light environments.
- ISO 800: For moving object photography or low light environments without using flash.
- ISO 1000: For moving object photography or low light environments without using flash.
- ISO 1600: For moving object photography or low light environments without using flash.



AE Metering

AE Metering allows you to select the area of the subject or frame by which the camera measures light. Use the **Up/Down** navigation buttons to select from the options. 3 AE metering settings are available:

- Matrix (default): Camera metering is set for evaluating 16 zones of objects with intelligent weighting in the frame.
- Spot: Camera metering is set for the brightness of a single object in the center of the frame.
- Average: Camera metering is set for the average brightness of objects in the frame.



Color

The **Color** setting allows you to take photos and apply different colors or color tones for an artistic effect. Use the **Up/Down** navigation buttons to select from the options. 4 color settings are available:

- Vivid
- Color (default)
- Black & White
- Sepia

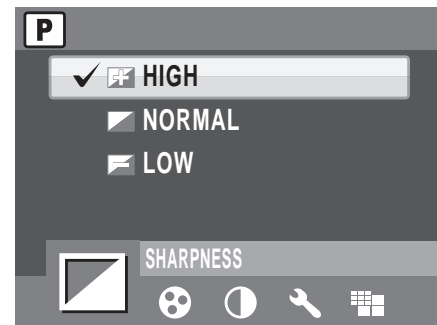


The Capture Menu

Sharpness

The **Sharpness** setting allows you to enhance the finer details of your photos. Use a higher setting for very sharp photos and a lower setting for a soft-toned photo. Use the **Up/Down** navigation buttons to select from the options. 3 sharpness settings are available:

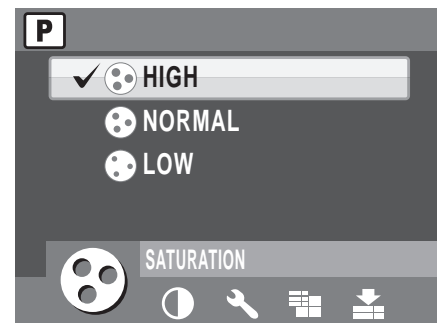
- High
- Normal (default)
- Low



Saturation

The **Saturation** setting allows you to adjust the saturation of the colors in your photos. Use a high saturation setting for rich colors and a lower saturation setting for more natural tones. Use the **Up/Down** navigation buttons to select from the options. 3 saturation settings are available:

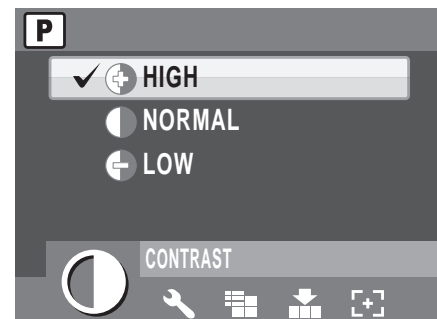
- High
- Normal (default)
- Low



Contrast

The **Contrast** setting allows you to adjust the contrast of your photos. Use the **Up/Down** navigation buttons to select from the options. 3 contrast settings are available:

- High
- Normal (default)
- Low




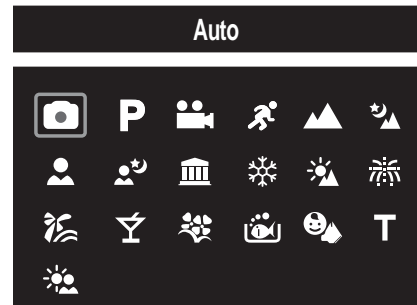
Setup

See "The Setup Menu" on page 39 for more details on the setup menu options.

Video Capture Menu

To access the video menu:

1. Press the **SCENE** button and scroll to **Video**  mode and press the **OK** button to enable the Video function. Press again to enable the anti-shake function.
2. Press the **MENU** button to display the menu options.
3. Refer to the following sections for more detailed information about each setting.



Video Resolution

The **Video Resolution** setting allows you to adjust the resolution at which your videos are recorded. 2 video size settings are available:

- 640X480
- 320X240



White Balance

See "White Balance" on page 25 for more details on the setup menu options.

Color

See "Color" on page 26 for more details on the setup menu options.

Saturation

See "Saturation" on page 27 for more details on the setup menu options.

Contrast

See "Contrast" on page 27 for more details on the setup menu options.

Setup

See "The Setup Menu" on page 39 for more details on the setup menu options

Note: All the options in the Capture Menu may vary according to the different modes.

Photo & Video Playback

Playback Mode Display


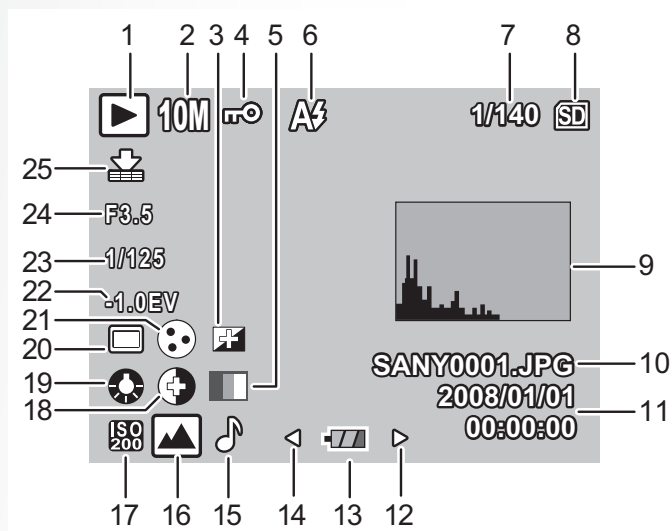
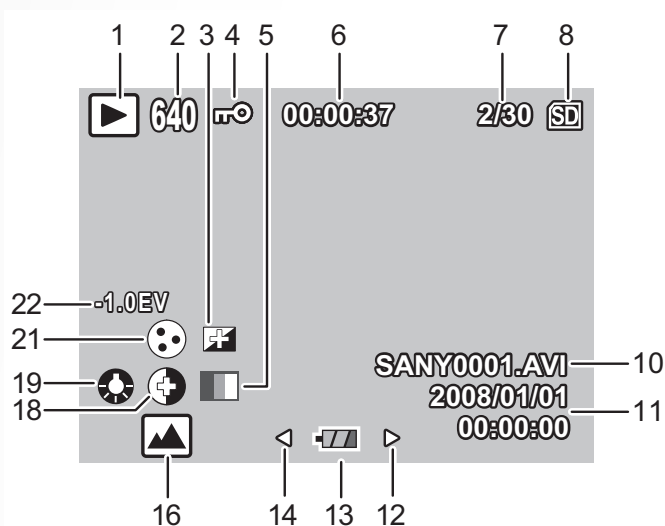
Press the Down  navigation button at Playback mode.







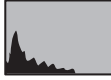






Photo Playback

















Video Playback



30 Photo & Video Playback


No.	Name	Icon
1	Playback mode	
2	Image resolution	Photo mode: 10M 8M 6M 5M 3M 1M VGA Video mode: 640 (640x480), 320 (320x240)
3	Sharpness	
4	Protect	
5	Color mode	
6	Flash mode	Photo mode:  Video mode: 00:00:00 (Time of the video clip.)
7	Quantity	1/140, 2/30
8	SD card / Internal memory	
9	Histogram	
10	File Name	Photo mode: SANY0001.JPG Video mode: SANY0001.AVI
11	Date and Time	2008/08/01 00:00:00
12	 Next	Move to next item.
13	Battery status	
14	 Previous	Move to previous item.
15	Voice memo	
16	Mode icons	Please see "Capture/Video Mode Display" on page 9 for detailed information.
17	ISO Speed	
18	Contrast	

Playback Mode Display

19	White balance	    
20	AE Metering	  
21	Saturation	  
22	EV Compensation	+2.0EV ~ -2.0EV
23	Shutter speed	Approx. 1/2000 sec. ~ approx. 4 sec.(Automatic)
24	Aperture value	Wide: F2.9~F5.5/ Tele: F5.2~F10.0 (Automatic)
25	Image quality	  


Viewing Photos/Videos on the LCD Screen

To view your photos and video files on the LCD screen:

1. Press the **Playback** button . The most recent photo or video clip is displayed.
2. Use the **Left/Right** navigation buttons to scroll through photos and video clips.
3. Press the **OK** button to begin playback of a video clip.
4. Press the **Left/Right** navigation buttons at any time during playback to skip to the previous/next photo or video.
5. Press the **OK** button then press the **Left/Right** navigation buttons to fast-rewind/fast-forward during video playback.
6. Press the **OK** button at any time during playback to pause the video.
7. After the video clip finishes playing, the LCD screen displays the first frame of the clip.

Viewing M-Burst Photos

To view your multi-burst photos on the LCD screen:

1. Press the **Playback** button . The most recent photo or video clip is displayed.
2. Use the **Left/Right** navigation buttons to scroll through photos.
3. When reviewing a multi-burst image, it will be displayed from the 1st frame to the 16th frame at 2 frames per second like a slideshow.
4. To stop the M-Burst slideshow, press the **Left/Right** navigation buttons and skip to the previous/next image.

32 Photo & Video Playback

Listening to Voice Memo

A voice memo plays simultaneously when playing a saved image with voice memo.

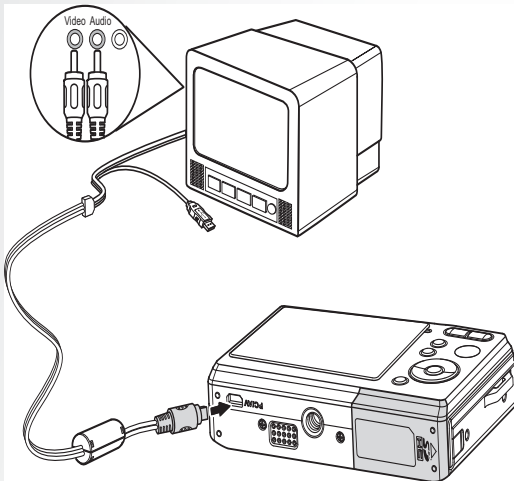
To stop a voice memo while reviewing an image, press the **OK** button.

To skip to previous/next image, press the **Left/Right** navigation buttons.

Viewing Photos/Videos on your TV

To view images stored on the camera on your TV, you must connect via the PC/AV port on the bottom of the camera. To connect your camera to a TV:

1. Turn on the camera and make sure that the camera's video out format is set to the same as that of the TV. See "**Video Out**" on page 41 for more information.
2. Connect the USB/AV 3-in-1 cable to the PC/AV port on the camera.
3. Connect the other end of the cable to the TV's AV input sockets.





4. The LCD screen turns black and all images and video clips are displayed on the TV screen. Follow the same steps described in "Viewing Photos/Videos on the LCD Screen" on page 31.

Viewing Photos/Videos on your TV

Zooming In/Out During Playback

The camera's zoom feature can also be used during playback. This allows you to view photos in greater detail.



To zoom in/out on saved photos:

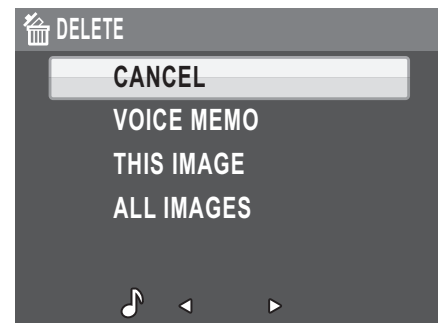
1. Press on the right side of the **Zoom** button **T**  to zoom in and on the left side of the **Zoom** button **W**  to zoom out of the photo.
2. Use the 4-way navigation buttons to pan across the image.
3. When zoomed in on a photo, press the **OK** button to crop the image. When zoomed out to the minimum, the LCD screen will display all photos and videos as a series of thumbnails.

Deleting Photos/Videos

The **Delete** function allows you to remove unwanted files stored on internal memory or a memory card.

To delete a photo/video:


1. In **Playback** mode, press the **Up/Flash** /
Delete  navigation button to display the **Delete** menu.
2. Press the **Up/Down** navigation buttons and the **OK** button to select from the 4 available options:
 - Cancel: Select to cancel the action and exit to the main menu.
 - Voice Memo/This Video: Select to delete the voice/the video of the current image.
 - This Image: Select to delete the current image.
 - All Images: Select to delete all images.



Using the Playback Menu

Access the playback menu to view further information, configure printing settings, view a slideshow, or delete photos or movies.

To access the playback menu:

1. Press the **Playback** button .
2. Press the **MENU** button to display the menu options. Use the **Left/Right** navigation to select the function from the menu, and press the **OK** button to enter.
3. Use the **Up/Down** navigation buttons to highlight an option and press the **OK** button to confirm.



34 Photo & Video Playback

DPOF

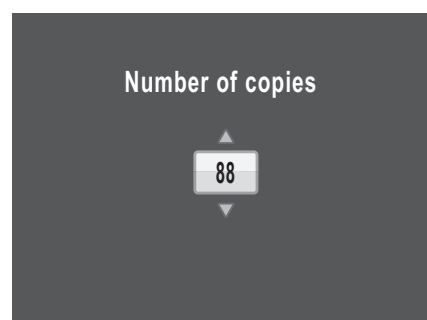
DPOF (Digital Print Order Format) allows you to specify the number of copies of a certain image that you want to print at a later date.

Use this function to tag pictures stored in your memory card with print information. You can tag all pictures to be printed or just the current picture. You can also select how many copies print and whether to include the date and time.

When all images to be printed are tagged, remove the memory card and take it to a photographic shop for printing, or use it with a DPOF compatible printer.

To set DPOF:

1. Press the **MENU** button to select **DPOF** from the menu at the playback mode, then press the **OK** button to enter the DPOF function.
2. Press the **Up/Down** navigation buttons and the **OK** button to select from the available options:
 - This Image: Select to print the current image.
 - All Images: Select to print all images.
 - Exit: Select to exit to the main menu.
3. Use the **Up/Down** navigation buttons to set the number of copies you wish to print.

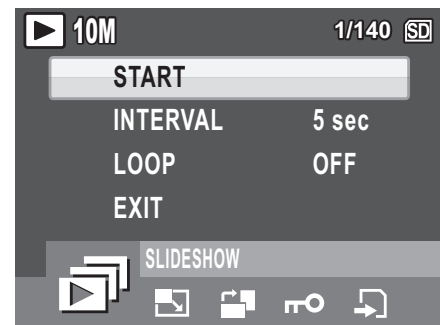


Slideshow

The **Slideshow** function allows you to view all stored photos in a continuous sequence.

To view a slideshow:

1. Press the **MENU** button to select **Slideshow** from the menu, then press the **OK** button to enter the Slideshow function.
2. Press the **Up/Down** navigation buttons and the **OK** button to select from the available options:
 - Start: Select to start the slideshow.
 - Interval: Select to set the interval time between each photo during the slideshow. Use the **Left/Right** navigation buttons to set a value in seconds. The default setting is 5 seconds.
 - Loop: Select to enable/disable a continuous loop of the slideshow. Select **ON** or **OFF** (default) from the submenu.
 - Exit: Select to exit to the main menu.

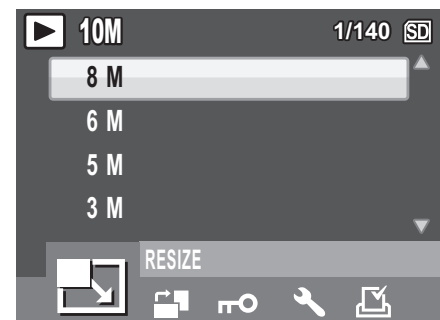


Resize

The **Resize** function allows you to change the image resolution.

To resize a photo:

1. Press the **MENU** button to select **Resize** from the menu, then press the **OK** button to enter the Resize function.
2. Press the **Up/Down** navigation buttons and the **OK** button to select the resize ratio you require: 8M, 6M, 5M, 3M, 1M and VGA.
3. Select **Exit** to return to the main menu.



Note: It is only possible to scale-down image resolutions. If the current image resolution is VGA, this menu item is disabled in the Resize submenu. The ratio of the image (3:2 or 16:9) remains unchanged after resizing.


- This function only supports native pictures
- Cropped images cannot be resized
- If there is not sufficient storage space, images cannot be resized
- If the SD/MMC card is locked, images cannot be resized
- VGA images cannot be resized

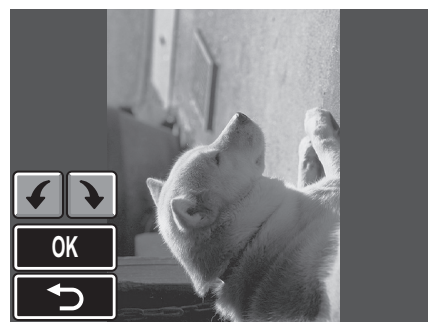
36 Photo & Video Playback

Rotate

The **Rotate** function allows you to change the orientation of a saved photo.

To rotate an image:



1. Press the **MENU** button to select **Rotate** from the menu. Press the **OK** button to enter.
2. Press the **Left/Right** navigation buttons and the **OK** button to rotate the select image.
 - **OK**: Select to rotate the image.
 - : Select to exit to the main menu.



Protect

You can lock a photo or video to protect it from being accidentally erased.

To lock a photo or video:

1. Press the **MENU** button to select **Protect** from the menu and press the **OK** button to enter.
2. Use the **Up/Down** navigation buttons to select **Lock**  or **EXIT**, then press the **OK** button to confirm the one you needed.
3. A key  icon displays at the top of the screen to indicate the photo/video is now locked.



Using the Playback Menu

Move

The **Move** function allows you to move images stored in internal memory to a memory card.


To move an image:

1. Press the **MENU** button to select **SETUP** from the menu. Press the **OK** button to confirm.
2. Select the **IMAGE STORAGE** from the menu. Press the **OK** button to confirm. Select the **INTERNAL MEMORY** from the menu. Press the **OK** button to confirm.
3. Press the **MENU** button to select **MOVE** from the menu. Press the **OK** button to confirm.
4. Press the **Up/Down** navigation buttons and the **OK** button to select from the 3 available options:
 - This Image: Select to move the current image to a memory card.
 - All Images: Select to move all images to a memory card.
 - Exit: Select to exit to the main menu.



Note: The Move function is only available when you choose internal memory as the storage media and an SD card has been inserted into the camera.

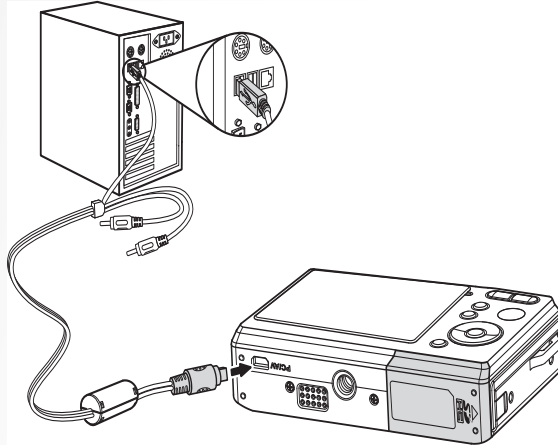
Back to AUTO memory mode:

1. Press the **MENU** button. Select **SETUP** from the menu and press the **OK** button to confirm.
2. Select the **IMAGE STORAGE** from the menu. Press the **OK** button to confirm.
3. Select **AUTO** from the menu. Press the **OK** button to confirm.
4. Press the **PLAYBACK**  button.

Transferring Photos/Videos to your PC

To transfer photos and videos to your PC:

Connect the camera's PC/AV port to a free USB port on your PC using the USB cable.



The camera's internal memory and/or SD/MMC card appear as removable drives in the file manager. Copy the files from the drives to the directory on your PC.

Use ArcSoft PhotoImpression and ArcSoft VideoImpression (provided on the software CD) to view or edit the photos and videos respectively.

Camera Settings

The Setup Menu

The setup menu, available in capture and playback modes, allows you to configure the camera's general settings according to your preferences.

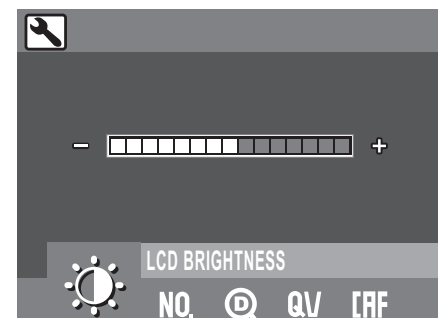
To access the setup menu:

1. Press the **MENU** button when in **Playback** or any of the capture modes.
2. Select **Setup** from the menu. Press the **OK** button to enter, then the submenu appears.
3. Use the **Left/Right** navigation buttons to scroll through the options and press the **OK** button to enter further submenus and to confirm your selection. Refer to the following sections for more detailed information about each setting.



LCD Brightness

The **LCD Brightness** setting allows you to brighten or darken the LCD backlight. Press the **OK** button to enter. Use the **Left/ Right** navigation buttons to increase or decrease the brightness.



File Number

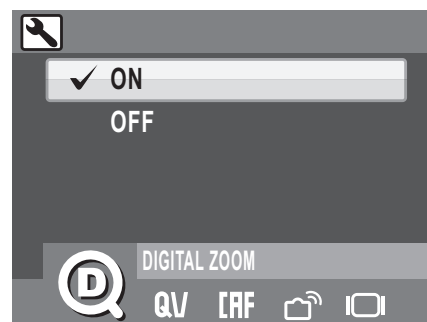
The **File No.** setting allows you to reset all file numbers assigned to each of the files on your camera. Press the **OK** button to confirm. Select **RESET** to reset or **CONTINUE** to set the file numbers in continuous order.




40 Camera Settings

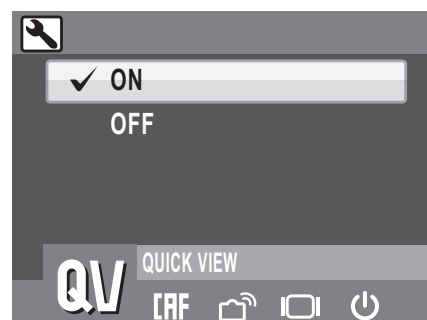
Digital Zoom

The **Digital Zoom** setting allows you to turn the digital zoom function on or off. Press the **OK** button to confirm. Select **ON** to enable the function or **OFF** (default) to disable it.



Quick View

The **Quick View** setting allows you to view the photo that you have just taken. Once you have taken your photo, it displays on the LCD screen. If you are not satisfied with the result, you can press the  button to delete the photo immediately. Press the **OK** button to confirm. Select **ON** (default) to enable the function or **OFF** to disable it.

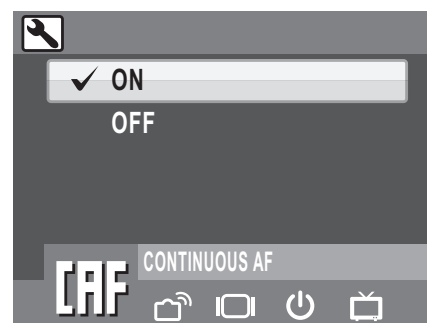


Note:

The Quick View function is not available in Burst and M-Burst modes.

Continuous AF

The **Continuous AF** setting allows you to turn the continuous auto focus function **ON** or **OFF**. Press the **OK** button to enter. Select **ON** to enable the function or **OFF** (default) to disable it.



Camera Sound

The **Camera Sound** setting allows you to adjust the camera sound level. You can also set the start-up and shutter sound when you turn on the camera and press the shutter button. Available options are as follows:

- Volume: Off, Low (default), Normal, High
- Start-up: Sound 1 (default), Sound 2, Sound 3
- Shutter: Sound 1 (default), Sound 2, Sound 3
- Exit: Select to discard the changes and return to the main menu.



The Setup Menu

Auto LCD Off

The **Auto LCD Off** setting allows you to adjust the length of time that the LCD screen will remain lit before turning off to save battery power. 3 options are available:

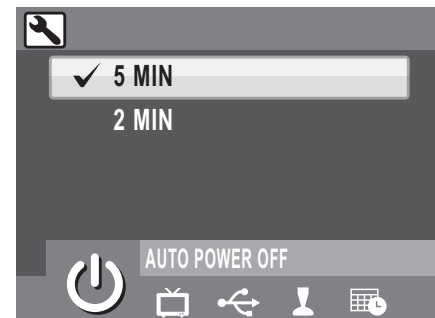
- OFF (default)
- 30 SEC
- 1 MIN



Auto Power Off

The **Auto Power Off** setting allows you to adjust the length of time after which the camera will power down when inactive. Use the **Up/Down** navigation buttons to select from the menu options. 2 options are available:

- 5 MIN (default)
- 2 MIN



Video Out

The **Video Out** setting allows you to adjust the video output, depending on the type of your TV. Use the **Up/Down** navigation buttons to select from the menu options. 2 options are available:

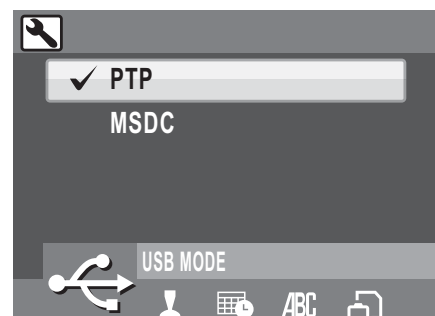
- NTSC (default)
- PAL



USB Mode

The **USB Mode** setting allows you to select the transfer method between your camera and your PC. 2 options are available:

- PTP (PictBridge Print): When the camera is connected to a printer by a USB cable which supports Pictbridge, it can directly print images stored on the media. For details on PTP function, please See “PictBridge Print (PTP)” on page 44.
- MSDC (default): The camera is set up to act as a mass storage device, allowing only for transfer of files between your camera and PC.

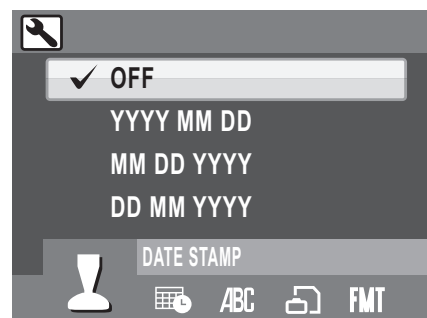


42 Camera Settings

Date Stamp

The **Date Stamp** setting allows you to adjust the format in which the date will appear on each photo or video. You can also deactivate this function if you wish. Setting a date stamp allows for easy sorting and the date will appear on the photo when printed. Press the **OK** button to confirm. Use the **Up/Down** navigation buttons to select from the menu options. 4 options are available:

- OFF (default)
- YYYY MM DD: year-month-date format
- MM DD YYYY: month-date-year format
- DD MM YYYY: date-month-year format



Date and Time

The **Date and Time** setting allows you to set or adjust the date and time on your camera. To set or adjust the date and time:

Press the **OK** button to confirm.

- Press the **Left/Right** navigation buttons to select the **Year** field.
- Press the **Up/Down** navigation buttons to adjust the **Year** value.
- In the same way, select the **Month**, **Date**, **Hour** and **Minute** fields and adjust them accordingly.



Language

The **Language** setting allows you to choose which language the OSD menu uses. Scroll down the list and select your language. Press the **OK** button to confirm. Use the **Up/Down** navigation buttons to select from the menu options.

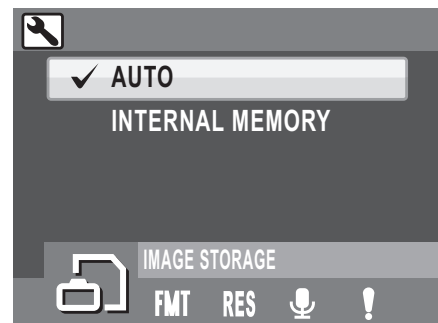


The Setup Menu

Image Storage

The **Image Storage** setting allows you to specify where photos and video clips will be stored. The camera features 16 MB internal memory but you can also insert an SD/MMC card (See “Inserting an SD/MMC Memory Card” on page 15 for more details). 2 options are available:

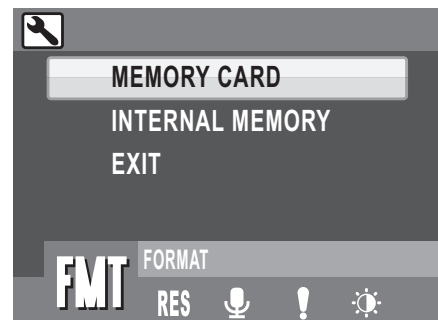
- **Auto (default):** When selected, the camera chooses the storage medium automatically. If an SD/MMC card is inserted in the camera, all photos and videos are stored on the card. If an external card is not detected, all photos and videos are stored in the internal memory.
- **Internal Memory:** All photos and videos are stored in the internal memory.



Format

The **Format** setting allows you to erase all data in the internal memory or on the SD/MMC card. Press the **OK** button to confirm. Use the **Up/Down** navigation buttons to select from the menu options. 3 options are available:

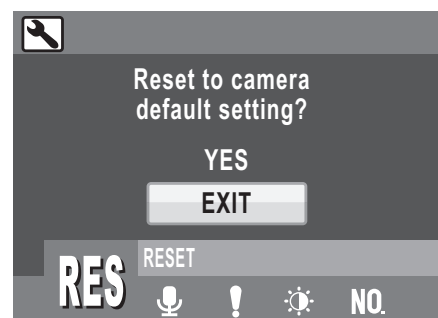
- **Memory Card (default):** All data on the SD/MMC will be formatted.
- **Internal Memory:** All data in the internal memory will be formatted.
- **Exit:** Cancel format action.



Reset

The **Reset** setting allows you to reset the camera to the original factory default settings. This means all modifications you have made to the camera settings will be cleared.

Once selected, the **Reset** screen displays a confirmation message. Press the **OK** button to enter selection function, select **YES** to proceed with the **Reset** or **EXIT** (default) to cancel.



44 Camera Settings

Voice Memo

The **Voice Memo** setting allows you to record a voice memo when a photo is taken. Select **ON** to enable the Voice Memo function or **OFF** (default) to disable it.



About

The **About** screen allows you to check the current firmware version of the camera.



PictBridge Print (PTP)

The **PTP** function allows you to print images captured by the camera directly without connecting the camera to a PC.

If the camera is not connected to a PTP compliant printer, an error message displays on the LCD screen. To enable PTP function, see "USB Mode" on page 41 for detailed information. If the USB mode is not set at PTP, an error message displays on the LCD screen.

When a PTP compliant printer is connected to the camera, the **Printer Connecting** screen displays on the LCD screen. The Print menu pops up automatically.



PictBridge Print (PTP)

Use the **Up/Down** navigation buttons to select an option and press the **OK** button to confirm.



Image Storage

See “Image Storage” on page 43 for detailed information.

This Image

Print the selected image with the current setting.

1. Use the **Up/Down** navigation buttons to select **THIS IMAGE** from the options and press the **OK** button to confirm. Use the **Left/Right** navigation buttons to select previous/next file.

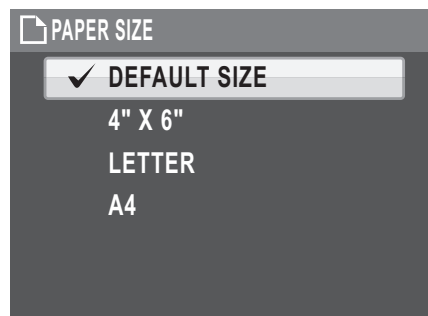


2. Press the **Up/Down** navigation buttons to set the number of copies and press the **OK** button to enter.



3. Press the **Up/Down** navigation buttons again to select the paper size and press the **OK** button to enter.

- DEFAULT SIZE
- 4" x 6"
- LETTER
- A4



4. Press the **Up/Down** navigation buttons to Continue or Cancel the action and press the **OK** button to enter.



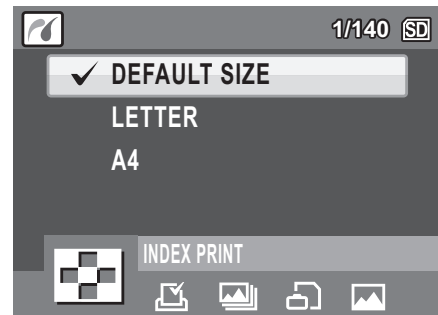
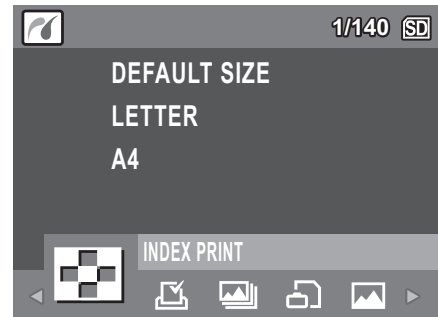
Index Print

Use this function to print all images in index format.

1. Press the **Up/Down** navigation buttons to select the Paper size and press the **OK** button to enter.

- DEFAULT SIZE
- LETTER
- A4

2. Press the **Up/Down** navigation buttons to set the number of copies. After the number of copies is set, press the **Up/Down** navigation buttons again to continue or cancel the action and press the **OK** button to enter.



DPOF Image

See "DPOF" on page 34 for detailed information.

48 Camera Settings

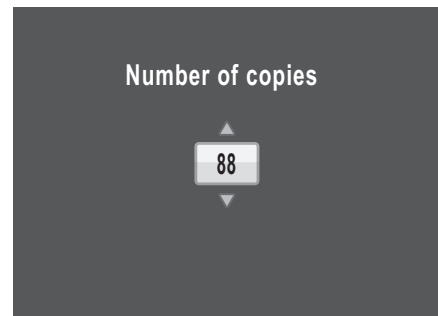
All Images

Print all images saved in memory.

1. Use the **Up/Down** navigation buttons to select **ALL IMAGES** from the options and press the **OK** button to confirm.

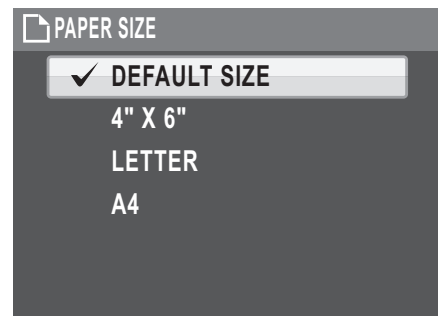


2. Press the **Up/Down** navigation buttons to set the number of copies and press the **OK** button to enter.



3. Press the **Up/Down** navigation buttons to select the Paper size and press the **OK** button to enter.

- DEFAULT SIZE
- 4" x 6"
- LETTER
- A4



4. Press the **Up/Down** navigation buttons to select Continue or Cancel this action and press the **OK** button to enter.



Specifications

General	Resolution / Image Type	10M Pixels / 1/2.3x" CCD
	LCD	2.4"TFT, 113,000 Pixels
	Dimensions	95(W)x59.5(H)x24.5(D)mm
	Exterior Casing	Plastic housing + Chromed plastic center frame
Optics	Aperture	Wide: F2.9 - F5.5 Tele: F5.2 - F10.0
	Optical Zoom	Up to 3x
	Digital Zoom	Up to 5x
	Focal Length	Wide(W): 32mm, Tele(T): 96mm
	Photo Graphic Range	Normal: 0.6 m ~ infinity Macro: 0.1m to 0.7m
	Shutter Speed	4 ~ 1/2000 Sec.
	Viewfinder	None
	Field of View	96% by LCD
Camera Features	Auto Power Off / Time Out	Yes
	ISO Equivalent	Auto, ISO100/200/400/800/ 1000/1600
	External Memory	Support SD/MMC card from 32MB to 16GB
	Flash Modes	Auto, Off, Fill, Red-eye
	Shooting Mode	Auto, P-Mode, Video, Sport, Landscape, Night Landscape, Portrait, Night Portrait, Museum, Snow, Sunset, Fireworks, Beach, Party, Foliage, Aquarium, Kids & Pets, Copy, Backlight
	Tripod Mount	1/4" Standard
	Macro	Yes

50 Specifications

Image Resolution	Image File Formats	Still Image: JPEG (Exif2.21)
	Image Quality Mode	Still Image: 3648x2736, 3264x2448 3072x2304, 2592x1944 2048x1536, 1024x768 640x480 Movie Mode: 640x480@30fps, 320x240@30fps
	Quality Levels	Best, Better, Good
Capture Features	DPOF	Version 1.1
	Erase Protection	Yes
	Exposure Compensation	Selectable +/-2.0EV with 0.3/0.4 EV steps
	Sharpness	High, Normal, Low
	Color	Vivid, Color, Black&White, Sepia
	AE Metering	Matrix, Spot, Average
	Focus	Multi-Zone Center Selected area
	Flash Range	2.5m@wide
	Lens Thread	None
	Anti-Shake	Yes, High ISO
	Aperture Priority	Yes
	Shutter Priority	Yes
	Drive Mode	Single Mode, Burst Mode, Multi- Burst (VGA@16 shots)
	Quick Delete	Yes
	Quick View	Yes
	Quick Review	No
	Self Timer	2 or 10 seconds
	Playback Magnify	Up to 6X (10 steps)
	White Balance	Auto, Sunny, Tungsten, Fluorescent, Cloudy

Video	Video Out	PAL, NTSC
	Stream to SD/MMC	Yes
	Speaker	Yes, Mono
	Movie File Format	AVI
	Movie Length	Close to 80 min. Max. file size is 4G bytes.
	Microphone	Yes, Mono
Power	Battery	AA batteries x2 (Alkaline/NiMH/ Rechargeable)
	Battery Life	CIPA 150 images
Capability	Camera Interface	USB 2.0 high speed
	Host Platform	Windows XP/Vista
Standards	Operating Temperature	0°C ~ 40°C
	Language	English, German, French, Italian, Spanish, Portuguese, Simplified Chinese, Traditional Chinese, Russian, Turkish, Thai, Korean, Dutch

Troubleshooting

Problem	Action
Camera does not turn on	<ul style="list-style-type: none"> • The battery may be exhausted. Charge or replace the battery. • The battery is installed incorrectly. Re-insert the battery observing the correct polarity.
Camera turns off automatically	Press the Power button again to turn on the camera.
LCD turns off automatically	Press any button to turn on the LCD, when AUTO LCD ON mode (30 SEC or 1 MIN) is achieved.
Empty battery icon is displayed on the LCD then camera turns off	Battery is exhausted. Charge or replace the battery.
LCD screen displays 'Card Requires Formatting'	Memory card format not recognized. Re-format the memory card.
LCD screen displays 'Card is Full'	Memory card is full. Replace the memory card with a new one or delete unnecessary images from the existing card.
LCD screen displays 'Card is locked'	The card is protected by a protect switch mechanism. Move the switch to the unlock position.
Insufficient memory space to complete request	Insufficient space in memory to rotate an image. Delete unnecessary images.
No image displays on the TV screen	Incorrect TV-out type was selected. Set correct TV-out type to match your TV system.
Insufficient space on the card	Delete unnecessary images.



SANYO Electric Co., Ltd.
Printed in China

Free Manuals Download Website

<http://myh66.com>

<http://usermanuals.us>

<http://www.somanuals.com>

<http://www.4manuals.cc>

<http://www.manual-lib.com>

<http://www.404manual.com>

<http://www.luxmanual.com>

<http://aubethermostatmanual.com>

Golf course search by state

<http://golfingnear.com>

Email search by domain

<http://emailbydomain.com>

Auto manuals search

<http://auto.somanuals.com>

TV manuals search

<http://tv.somanuals.com>