

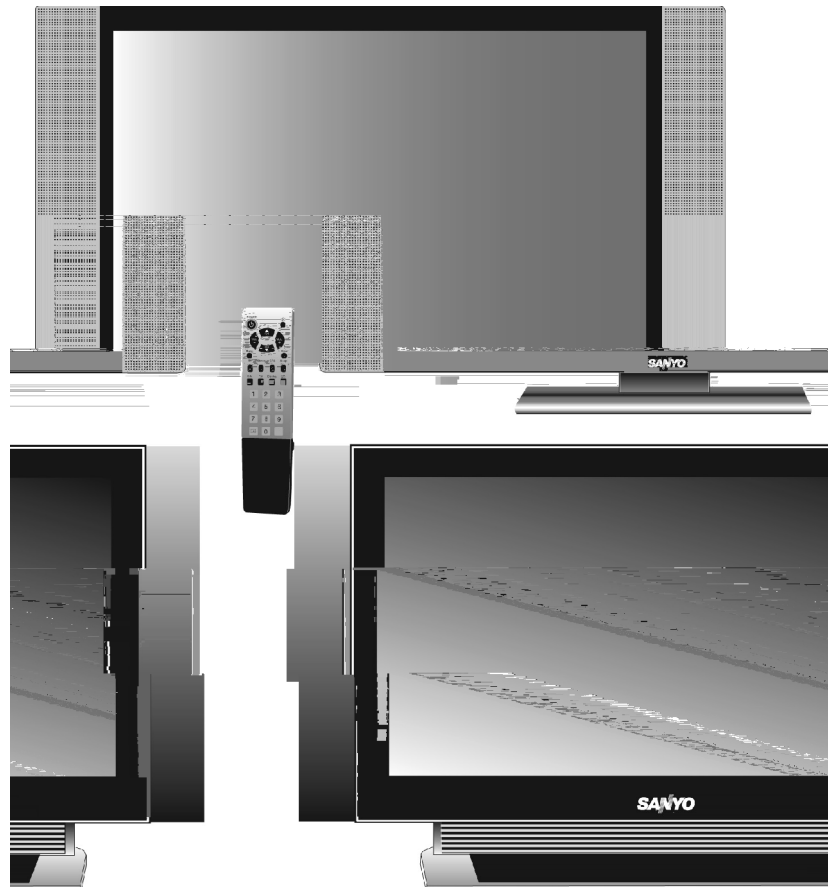

Instruction Manual

AVL-278/328/408 LCD
AVP-428 Plasma Display
Series

True HDTV Flat Panel TV



Save all packaging material for possible reshipment should you move, etc.

Subscribe to HDTV cable or satellite?

Please consult pages 23 & 26 for aspect ratio information in order to maximize your viewing experience.

Call our HELPLINE 1-800-263-2244 for further assistance.

SANYO Canada Inc.

www.sanyo.ca

Table of Contents

Important Information	1
Important Safety Precautions.....	2
Preparation	5
Using the Remote Control	5
Batteries for the Remote Control.....	5
Power Connection	5
Antenna Connection.....	6
Identification of Controls	7
Main Unit	7
Remote Control	9
Connections	11
Cautions Before Connecting.....	11
Connect a VCR.....	11
Connect a Camcorder.....	12
Connect a DVD player.....	13
Connect a DTV receiver	14
Connect a PC	15
Connect a VCR for Recording	16
Turning the Unit On and Off.....	17
Turning the Unit On and Off.....	17
Viewing the Menus and Displays.....	17
Memorizing the Channels	18
Selecting the Signal Source.....	18
Storing Channels in Memory Automatically	18
Adding and Erasing Channels	19
Basic Operations.....	20
Changing Channels	20
Adjusting the Volume.....	20
Select Input Source Signal	21
Selecting a Menu Language.....	21
Setting Picture.....	22
Customizing the Picture.....	22
Using the Preset Picture Mode.....	22
Setting System	23
Setting System In TV Mode.....	23
Adjusting Screen Aspect.....	23
Reducing Picture Noise	23
VCR mode	23
Loading Default Values.....	23
Setting System In VGA Mode	24
Changing the Position of Image.....	24
Adjusting Clock and Phase.....	24
Adjusting the Picture Automatically	24
Adjusting Screen Aspect.....	25
Display Resolution Information	25
Loading Default Values.....	25



Table of Contents (continued)

Setting System In YPbPr Mode	26
Adjusting Phase	26
Adjusting Screen Aspect	26
Reducing Picture Noise	26
Loading Default Values	26
Setting Sound	27
Customizing the Sound	27
Using the Preset Sound Mode	27
Setting SRS effect	27
Adjusting On-Screen Display	28
Adjusting OSD Position	28
Adjusting OSD Transparence	28
Zooming OSD Menu	28
Setting OSD Off Time	28
Loading default values	28
TVPC Operations	29
Viewing the TVPC	29
Selecting the Signal Source for the TVPC Frame	29
Changing Channels for the TVPC Frame	29
Changing the Position of the TVPC Frame	30
Adjusting the Size of TVPC Frame	30
Viewing Picture-by-Picture	30
Using Hotkeys	31
Setting Sleep Timer	31
Setting Audio Mode	31
Adjusting Back Light of the Panel	31
Freezing Picture	31
Viewing Closed Captions	32
Turning Closed Caption On or Off	32
Setting Closed Caption	32
Setting CC When Mute	32
Adjusting Child Lock Settings	33
Child Lock	33
Turning Child Lock On or Off	35
Changing the Password	35
Adjusting the Movie Rating	35
Adjusting the TV Rating	35
Adjusting Canadian English Rating	36
Adjusting Canadian French Rating	36
Troubleshooting	37
Specifications	38

Important Information

Thank-you for choosing SANYO. This product can display true HDTV (High definition) pictures. A subscription to your cable or satellite provider is required.

WARNING: TO REDUCE THE RISK OF FIRE OR ELECTRIC SHOCK, DO NOT EXPOSE THIS APPARATUS TO RAIN OR MOISTURE.

	CAUTION RISK OF ELECTRIC SHOCK DO NOT OPEN	
CAUTION- To reduce the risk of electric shock, do not perform any servicing other than that contained in the operating instructions unless you are qualified to		

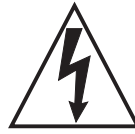

The lightning flash with arrowhead symbol within an equilateral triangle is intended to alert the user to the presence of uninsulated dangerous voltage within the product's enclosure that may be of sufficient magnitude to constitute a risk of electric shock to persons.



The exclamation point within an equilateral triangle is intended to alert the user to the presence of important operating and maintenance (servicing) instructions in the literature accompanying the appliance.

"Note to CATV system installer: This reminder is provided to call the CATV system installer's attention to Article 820-40 of the National Electrical Code that provides guidelines for proper grounding and, in particular, specifies that the cable ground shall be connected to the grounding system of the building, as close to the point of cable entry as practical."

This product utilizes tin-lead solder, and fluorescent lamp containing a small amount of mercury. Disposal of these materials may be regulated due to environmental considerations. For disposal or recycling information, please contact your local authorities or the Electronic Industries Alliance: www.eia.org

FCC STATEMENT

FCC Notice

LCD TV: A CLASS B digital device

This equipment has been tested and found to comply with the limits for a Class B digital device, pursuant to part 15 of the FCC Rules. These limits are designed to provide reasonable protection against harmful interference when the equipment is operated in a commercial environment.

This equipment generates, uses, and can radiate radio frequency energy and, if not installed and used in accordance with the instruction manual, may cause harmful interference to radio communications. Operation of this equipment in a residential area is likely to cause harmful interference in which case the user will be required to correct the interference at his own expense.

FCC CAUTION:

Pursuant to 47CFR, Part 15.21 of the FCC rules, any changes or modifications to this monitor not expressly approved by the manufacturer could cause harmful interference and would void the user's authority to operate this device.

WARNING: This is a CLASS B product. In a domestic environment this product may cause radio interference in which case the user may be required to take adequate measures to counter interference.

Important Safety Precautions

Electrical energy can perform many useful functions, but it can also cause personal injuries and property damage if improperly handled. This product has been engineered and manufactured with the highest priority on safety. But **IMPROPER USE CAN RESULT IN POTENTIAL ELECTRICAL SHOCK OR FIRE HAZARD**. In order to prevent potential danger, please observe the following instructions when installing, operating and cleaning the product. To ensure your safety and prolong the service life of your LCD TV product, please read the following precautions carefully before using the product.

1. Read these instructions---All operating instructions must be read and understood before the product is operated.

2. Keep these instructions---These safety and operating instructions must be kept in a safe place for future reference.

3. Heed all warnings---All warnings on the product and in the instructions must be observed closely.

4. Follow all instructions---All operating instructions must be followed.

5. Do not use this apparatus near water---for example, near a bathtub, washbowl, kitchen sink, or laundry tub, in a wet basement, or near a swimming pool, and the like. Do not use immediately after moving from a low temperature to high temperature environment, as this causes condensation, which may result in fire, electric shock, or other hazards.

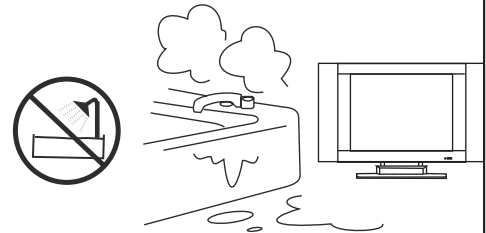

6. Clean only with dry cloth---Unplug this product from the wall outlet before cleaning. Do not use liquid cleaners or aerosol cleaners. Use a damp cloth for cleaning.

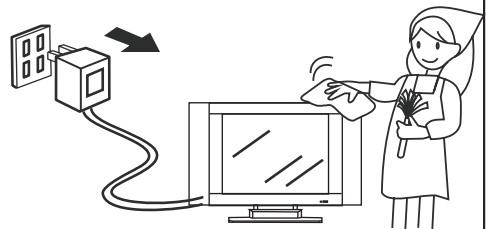

7. Ventilation---Do not block any ventilation openings. Install in accordance with the manufacturer's instructions. The vents and other openings in the cabinet are designed for ventilation. Do not cover or block these vents and openings since insufficient ventilation can cause overheating and/or shorten the life of the product. Do not place the product on a bed, sofa, rug or other similar surface, since they can block ventilation openings. This product is not designed for built-in installation; do not place the product in an enclosed place such as a bookcase or rack, unless proper ventilation is provided or the manufacturer's instructions are followed.

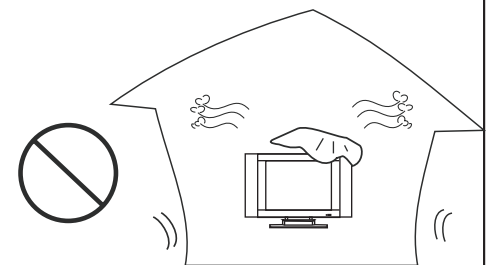

8. Heat sources---Do not install near any heat sources such as radiators, heat registers, stoves, or other apparatus (including amplifiers) that produce heat.

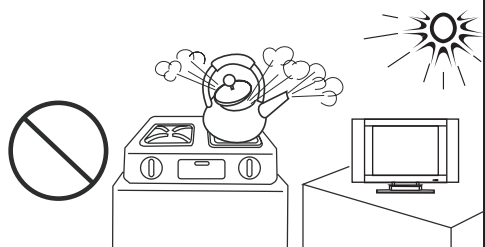

9. Grounding or Polarization---Do not defeat the safety purpose of the polarized or grounding-type plug. A polarized plug has two blades with one wider than the other. A grounding type plug has two blades and a third grounding prong. The wide blade or the third prong are provided for your safety. If the provided plug does not fit into your outlet, consult an electrician for replacement of the obsolete outlet.

10. Power cord protection---Protect the power cord from being walked on or pinched particularly at plugs, convenience receptacles, and the point where they exit from the apparatus.

11. Attachments---Only use attachments/accessories specified by the manufacturer. Do not use attachments not recommended by the manufacturer. Use of improper attachments can result in accidents.

Important Safety Precautions (continued)

12. Stand---Use only with the cart, stand, tripod, bracket, or table specified by the manufacturer, or sold with the apparatus. Do not place the product on an unstable trolley, stand, tripod or table. Placing the product on an unstable base can cause the product to fall, resulting in serious personal injuries as well as damage to the product. When mounting the product on a wall, be sure to follow the manufacturer's instructions. Use only the mounting hardware recommended by the manufacturer.

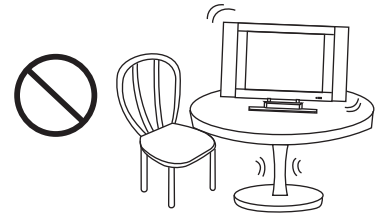

13. Move Carefully---When a cart is used, use caution when moving the cart/apparatus combination to avoid injury from tip-over. Sudden stops, excessive force and uneven floor surfaces can cause the product to fall from the trolley.



14. Lightning---Unplug this apparatus during lightning storms or when unused for long periods of time.

For added protection for this television equipment during a lightning storm, or when it is left unattended and unused for long periods of time, unplug it from the wall outlet and disconnect the antenna. This will prevent damage to the equipment due to lightning and power-line surges.

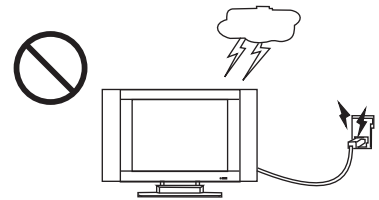

15. Servicing---Refer all servicing to qualified service personnel. Servicing is required when the apparatus has been damaged in any way, such as power-supply cord or plug is damaged, liquid has been spilled or objects have fallen into the apparatus, the apparatus has been exposed to rain or moisture, does not operate normally, or has been dropped.

16. Replacement parts---In case the product needs replacement parts, make sure that the service person uses replacement parts specified by the manufacturer, or those with the same characteristics and performance as the original parts. Use of unauthorized parts can result in fire, electric shock and/or other danger.

17. Overloading---Do not overload wall outlets, extension cords, or convenience receptacles on other equipment as this can result in a risk of fire or electric shock.

18. Entering of objects and liquids---Never insert an object into the product through vents or openings. High voltage flows in the product, and inserting an object can cause electric shock and/or short internal parts. For the same reason, do not spill water or liquid on the product.

19. Damage requiring service---If any of the following conditions occur, unplug the power cord from the AC outlet, and request a qualified service person to perform repairs.

- When the power cord or plug is damaged.
- When a liquid is spilled on the product or when objects have fallen into the product.
- When the product has been exposed to rain or water.
- When the product does not operate properly as described in the operating instructions.

Do not touch the controls other than those described in the operating instructions. Improper adjustment of controls not described in the instructions can cause damage, which often requires extensive adjustment work by a qualified technician.

- If the product has been dropped or the cabinet has been damaged in any way.
- When the product displays an abnormal condition or exhibits a distinct change in performance. Any noticeable abnormality in the product indicates that the product needs servicing.

20. Safety checks---Upon completion of service or repair work, request the service technician to perform safety checks to ensure that the product is in proper operating condition.

21. Wall or ceiling mounting---When mounting the product on a wall or ceiling, be sure to install the product according to the method recommended by the manufacturer. This is a safety feature.

Important Safety Precautions (continued)

22. Power source---This product is intended to be supplied by a listed power supply indicated on the marking label. If you are not sure of the type of power supply to your home, consult your product dealer or local power company. For added protection for this product during a lightning storm, or when it is left unattended and unused for long periods of time, unplug it from the wall outlet and disconnect the cable system. This will prevent damage to the product due to lightning and power line surges. When the unit has to be used with another power supply voltage, the power cable must be changed. Consult your product dealer. The socket outlet should be installed near the equipment and easily accessible. Use only the power cord designated by our dealer to ensure safety and EMC. When connecting other products such as VCRs and personal computers, you should turn off the power of the unit for protection against electric shock.

23. Panel protection---The LCD panel used in this product is made of glass. Therefore, it can break when the product is dropped or impacted upon by other objects. Be careful not to be injured by broken glass pieces in case the LCD panel breaks.

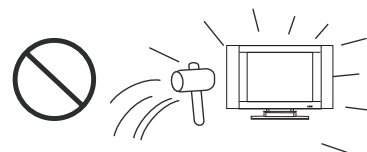

24. Pixel defect---The LCD panel is a very high technology product, giving you finely detailed pictures. Occasionally, a few non-active pixels may appear on the screen as a fixed point of blue, green or red. Please note that this does not affect the performance of your product.

< If an outside antenna is connected to the television equipment, be sure the antenna system is grounded so as to provide some protection against voltage surges and built-up static charges. Section 810 of the National Electrical Code provides information with respect to proper grounding of the mast and supporting structure, grounding of the lead-in wire to an antenna discharge unit, size of grounding conductors, location of antenna-discharge unit, connection to grounding electrodes, and requirements for the grounding electrode.

EXAMPLE OF ANTENNA GROUNDING AS PER NATIONAL ELECTRICAL CODE

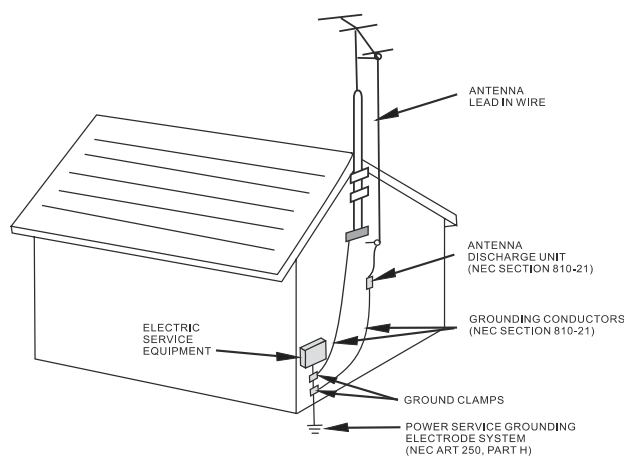

NEC—NATIONAL ELECTRICAL CODE

< An outside antenna system should not be located in the vicinity of overhead power lines or other electric light or power circuits, or where it can collide with such power lines or circuits. When installing an outside antenna system, extreme care should be taken to keep from touching such power lines or circuits, as contact with them might be fatal.

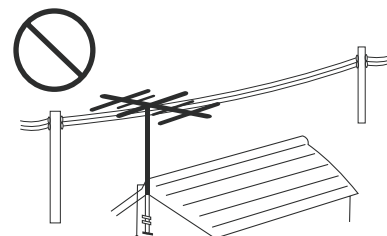

Preparation

Using the Remote Control

< Use the remote control by pointing it towards the remote sensor window of the set. Objects between the remote control and sensor window may prevent proper operation.

Cautions regarding use of remote control

- < Do not expose the remote control to shock. In addition, do not expose the remote control to liquids, and do not place in an area with high humidity.
- < Do not install or place the remote control under direct sunlight. The heat may cause deformation of the unit.
- < The remote control may not work properly if the remote sensor window of the main unit is under direct sunlight or strong lighting. In such a case, change the angle of the lighting or LCD TV set, or operate the remote control closer to the remote sensor window.

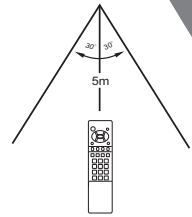

Batteries for the Remote Control

If the remote control fails to operate the LCD TV functions, replace the batteries in the remote control.

- 1 Open the battery cover.
- 2 Insert two size-AAA batteries.
- 3 Replace the cover and slide in reverse until the lock snaps.

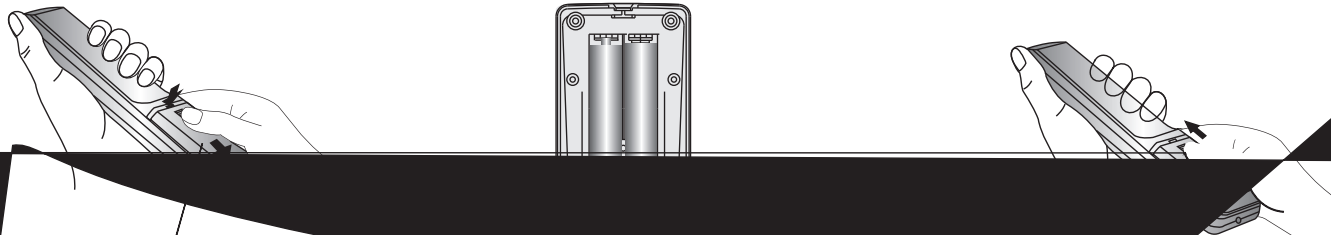

(Slide the cover while pressing down.)

corresponding to the (+) and (-) in the battery compartment.)

Precautions on battery use

- Improper use of batteries can result in a leakage of chemicals and/or explosion. Be sure to follow the instructions.
- < Place batteries with their terminals corresponding to the (+) and (-) indications.
- < Different types of batteries have different characteristics. Do not mix batteries of different types.
- < Do not mix old and new batteries. Mixing old and new batteries can shorten the life of new batteries and may cause leakage of chemicals.
- < Remove batteries as soon as they are non-operable. Chemicals that leak from batteries can be harmful. If leakage is found, wipe it up with a cloth.
- < The batteries supplied with the product may have a shorter life expectancy than standard batteries.
- < If the remote control is not used for an extended period of time, remove the batteries from the remote control.

SECTION

ector is built into
Terminal.
ffer "premium pa
s generally provide
r is necessary for
le TV company. O
w. Please note: An

RF switch (not

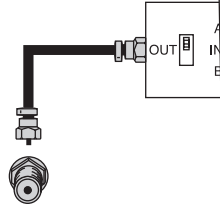

RF switch (not supplied) : Yc
RF switch (not supplied) :
el keys.

aler or Service Center for the ty

requirements for good color telev
n, a good quality outdoor antenna
is a brief explanation of the type of
-ohm system is generally a round c
be attached to a terminal without too
00-ohm system is a flat "twin-lead" c
terminal through a 300-75-ohm adapt

DOOR ANTENNA CONNECTION

one of the following two diagrams if you con
ng a VHF/UHF combination outdoor ant
ng separate VHF and/or UHF outdoor ant
ect the outdoor antenna cable lead-in-1.jc

DN

F/UHA antensON

Identification of Controls

Main Unit

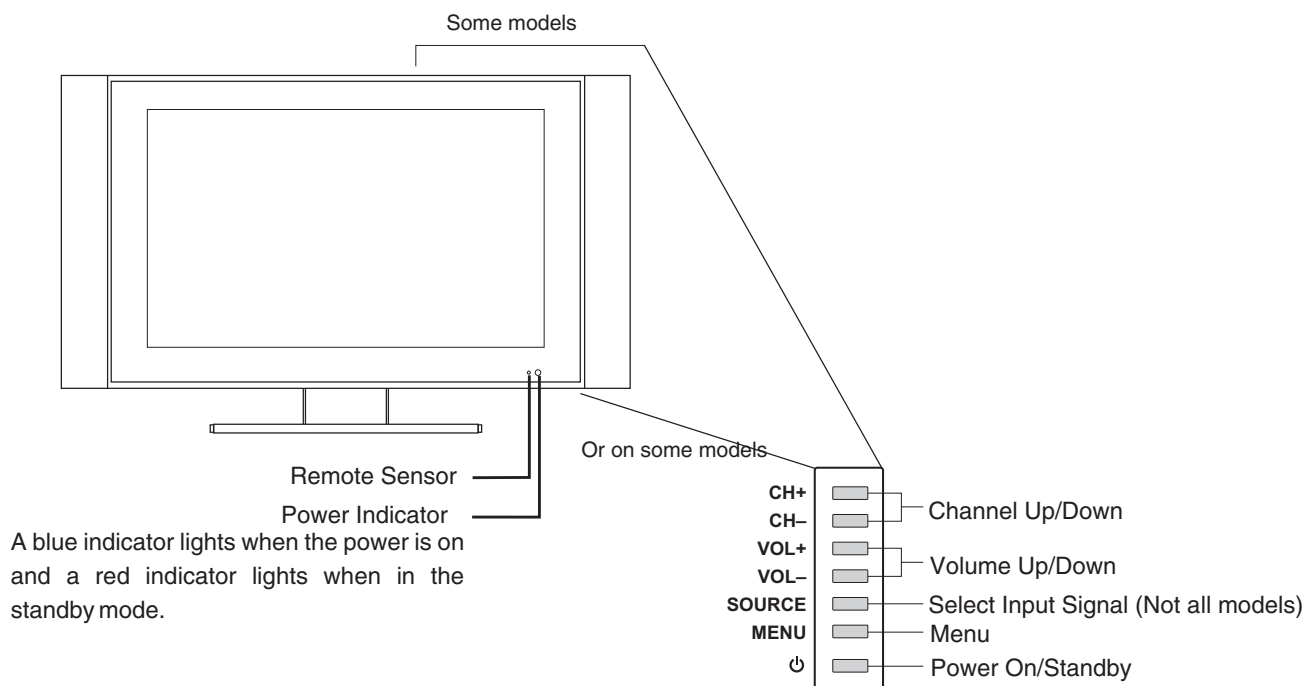

1. POWER ⏻

Press this button to turn the unit ON from STANDBY mode. Press it again to turn the set back to STANDBY.

2. MENU

Press this button to access the Menu main page.

3. SOURCE

To access signal source select menu. (Not all models)

4. VOL+/-

Press the VOL+ or VOL- button to directly increase or decrease the sound volume level; in OSD Menu, press these buttons to adjust the value or setting of each item.

5. CH+/-

Note:

Functions of **VOL+/-**, **CH+/-**, **MENU**, **SOURCE** and **POWER**⏻ are also provided on the remote control. This operation manual provides a description based on operating functions with the remote control.

Identification of Controls (continued)

ation, use
To access the Menu main page or exit menu operation

4. BK

To adjust panel backlight

5

ptions

panel select

8

source

To access source menu

Mute

and mute

er sub

of th

with the SRS s

4. Return

quickly in current cha

inc.

Identification of Controls (continued)

Remote Control

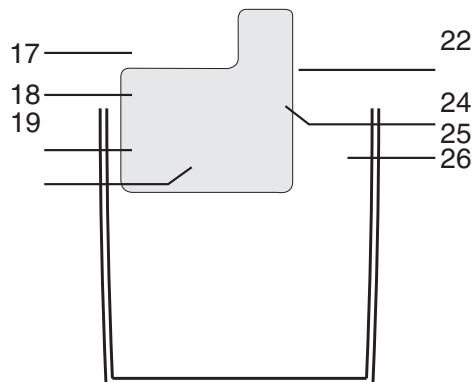
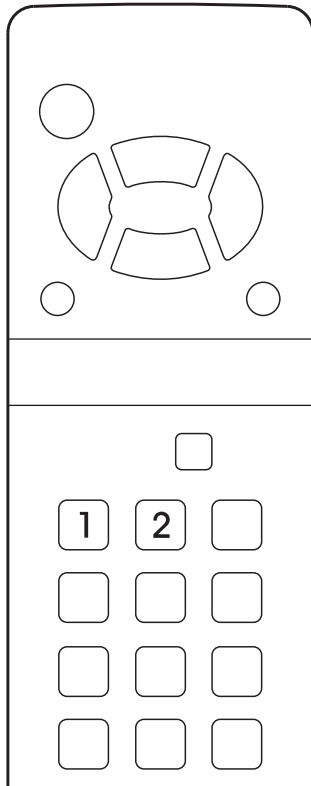

17. Auto

To rectify the picture automatically in VGA mode

18. PBP

To activate picture-by-picture

19. POS

To adjust TVPC frame position

20. TVPC

To activate TVPC function

21. P.S.

To select signal source for TVPC frame

22. CCD

To select CCD on/off and CCD channel

23. Up, Down

To change channel of TVPC frame

24. Screen

To select screen aspect ratio

25. Size

To adjust TVPC frame size

26. Still

To freeze current picture

Connections

Cautions Before Connecting

- Carefully check the terminals for position and type before making any connections.
- The illustration of the external equipment may be different depending on your model.
- Loose connectors can result in image or color problems. Make sure that all connectors are securely inserted into their terminals.
- Refer to the operating manual of the external device as well.
- When connecting an external device, turn the power off on the panel to avoid any issues.

Connect a VCR

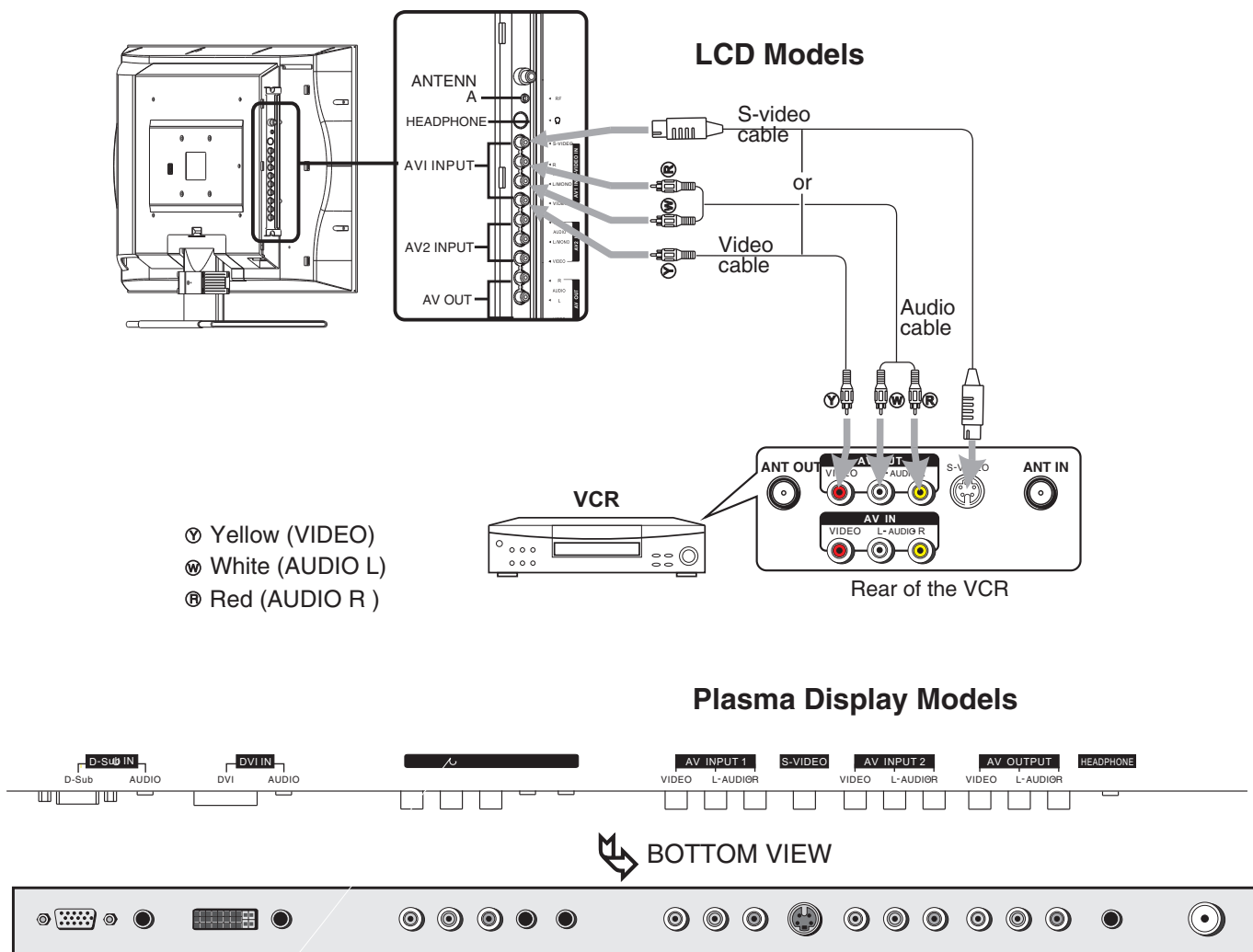

How to connect:

Connect the Audio/Video cables between the Audio (L/R)/Video jacks on the unit and VCR.

Note:

For better video, you can use the S-video terminal if your source supports it.

To play VCR

1. Turn on your TV, press **Source** button on the remote control.
2. Press **CH+/-** to select **Video1**(AV1 IN) or **SVideo** and press **Enter** to confirm.
3. Turn on your VCR, insert a videotape and press the Play button.

Source Select

VGA

RF

Video1

Video2

SVideo

YPbPr1

YPbPr2

Connect a Camcorder

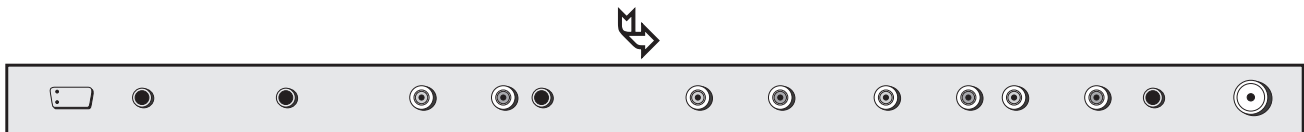
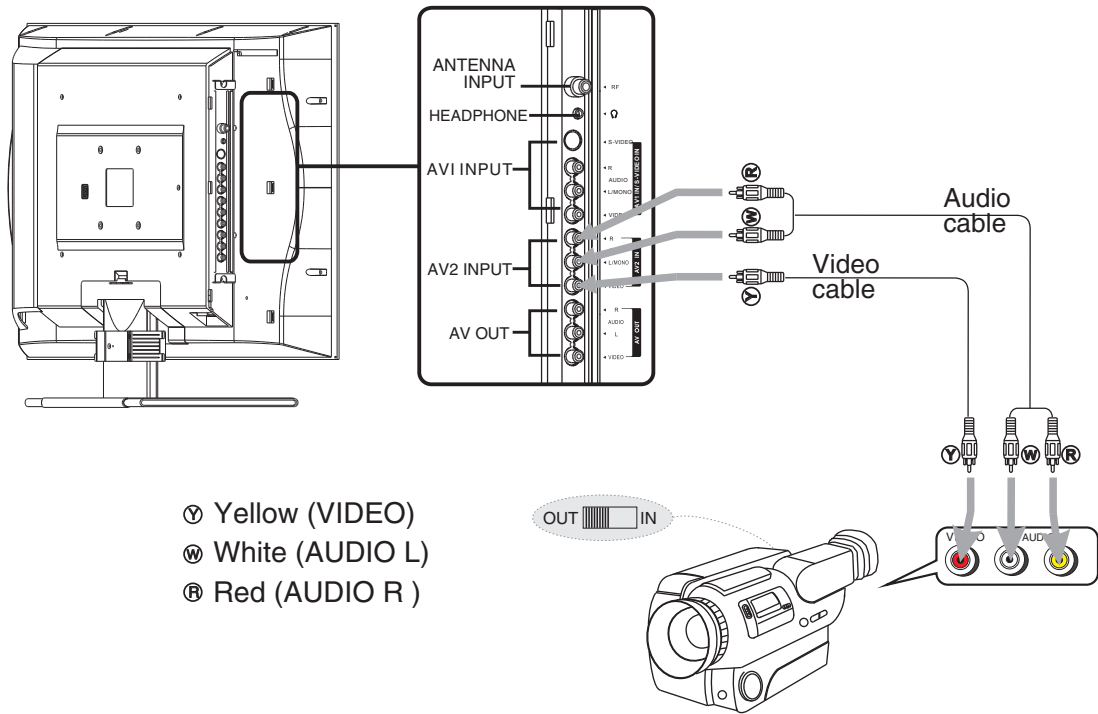

How to connect:

Connect the Audio/Video cables between the Audio (L/R)/Video jacks on the unit and camcorder.

To play back Camcorder

1. Turn on your TV, press **Source** button on the remote control.
2. Press **CH+/-** to select **Video2** and press **Enter** to confirm.
3. Turn on your camcorder and set it to output mode. (For details, refer to your camcorder owner's manual.)
4. Insert the tape into the camcorder and press Play button.

Notes:

The operation of the camcorder may be different, depending on your model. Please read the owner's manual of your camcorder to confirm operation.

For better video, you can use the S-video terminal if your source supports it.

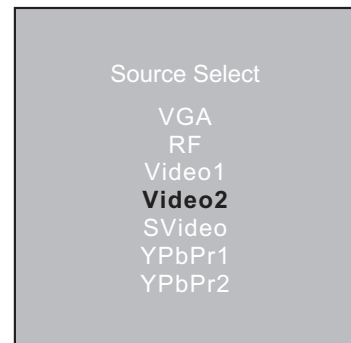

Connections (continued)

Connect a DVD player

LCD Models

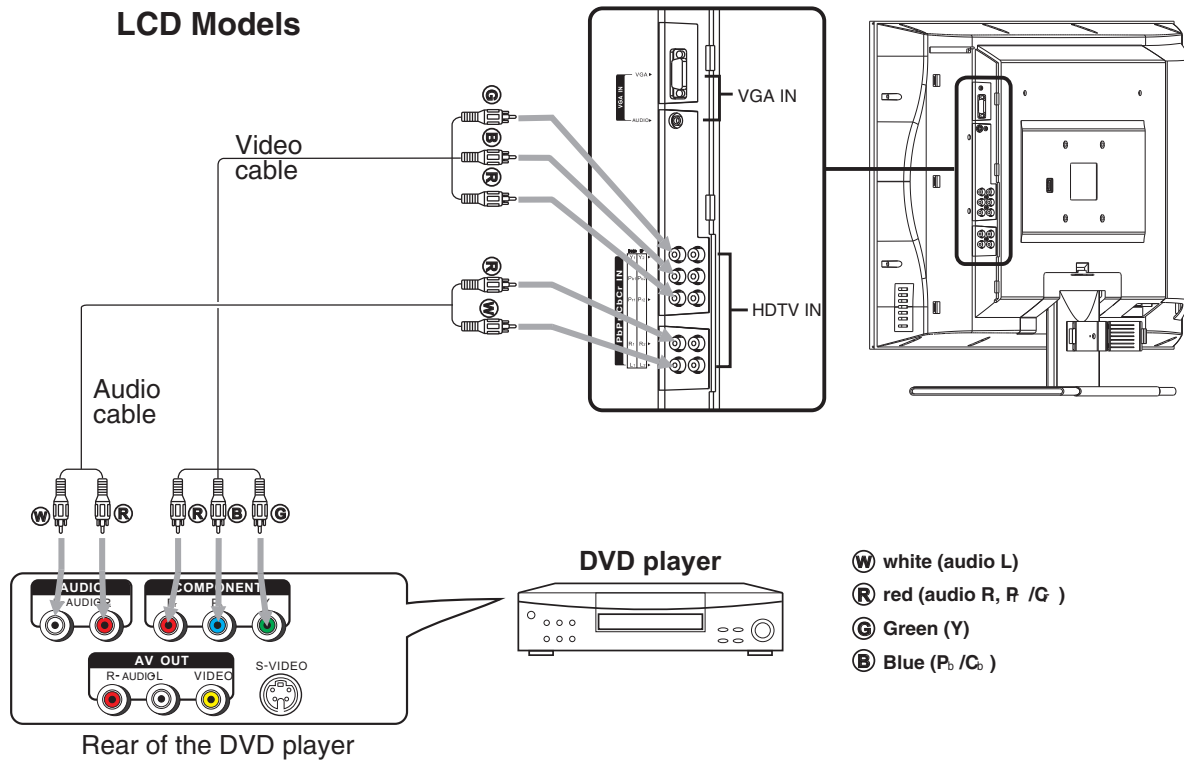

Plasma Display Models

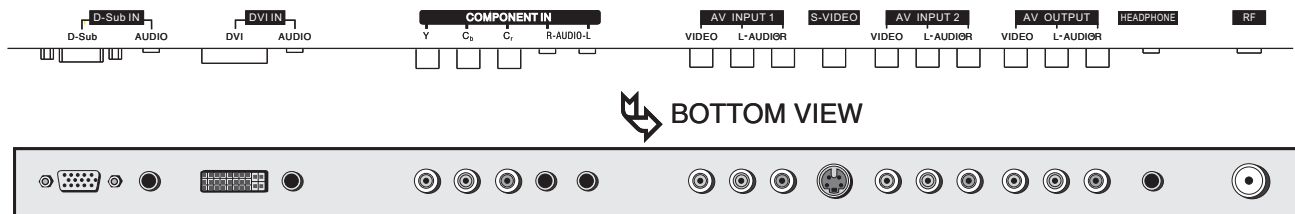

How to connect a DVD Player using Component Video Connections:

Connect the Video cable between the Y, Pb, Pr input jacks on the unit and Y, Pb, Pr (or Y, Cb, Cr) output jacks on the DVD player.

Connect the Audio cable between the AUDIO input jacks on the unit and AUDIO output jacks on the DVD player.

To play DVD

1. Turn on your TV, press **Source** button on the remote control.
2. Press **CH+/-** to select **YPbPr1** or **YPbPr2**.
3. Press **Enter** to confirm.
4. Turn on your DVD player, insert a DVD disc and press the Play

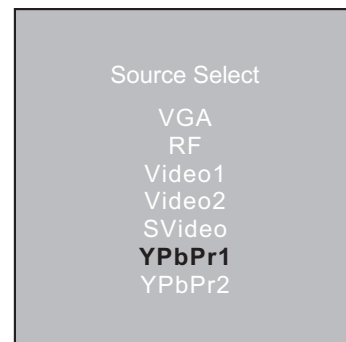

Additional source on some models : DVI

Connections (continued)

Connect a PC

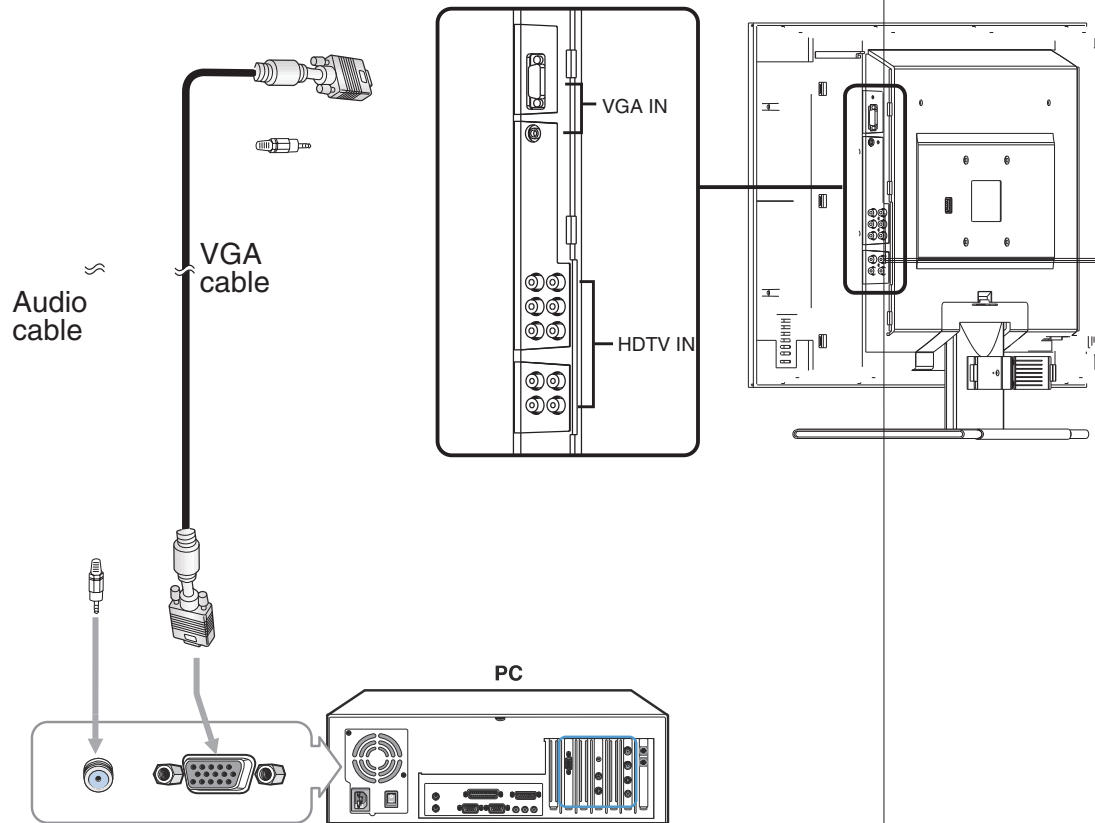

How to connect:

Connect a VGA cable between the VGA jack on the PC and the VGA input jack on the unit.
Connect an Audio cable between the AUDIO output on the PC and AUDIO input jack on the unit.

To Watch the PC screen

1. Turn on your TV, press **Source**  button on the remote control.
2. Press **CH+/-** to select **VGA**.
3. Press **Enter** to confirm.
4. Turn on your PC and check for PC system requirements.
5. Adjust the screen resolution and settings on your computer to the preferred settings.

Source Select

VGA
RF
Video1
Video2
SVideo
YPbPr1
YPbPr2

A

www
M v F
T O
T O
B O

Connect a VCR for Non-timer Recording

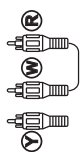

- Ⓜ Yellow (VIDEO)
- Ⓜ White (AUDIO L)
- Ⓜ Red (AUDIO R)

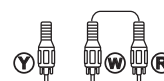

VIDEO L-AUDIGR

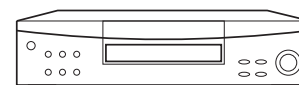

VCR for recording

Turning the Unit On and Off

Turning On

Insert the power cord into the wall outlet.
Press the **Power** ⏻ button on the remote control.
The unit will be turned on and you will be ready to use its features.

Turning Off

With the power on, Press the **Power** ⏻ button on the remote control to turn off.

Note:

You can also use the **Power** ⏻ button on the Control panel on the

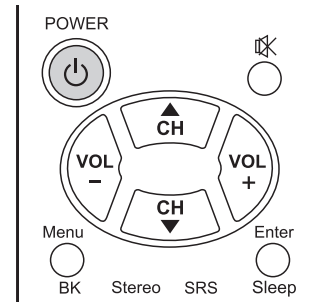

Viewing the Menus and Displays

Your LCD TV has a simple, easy-to-use menu system that appears on the screen. This system makes it convenient and fast to use features on the unit. The unit also lets you display the status of many of your LCD TV features.

Viewing the Menus

1 With the power on, press the **Menu** button on the remote control. The main menu appears on the screen. The picture menu is selected.

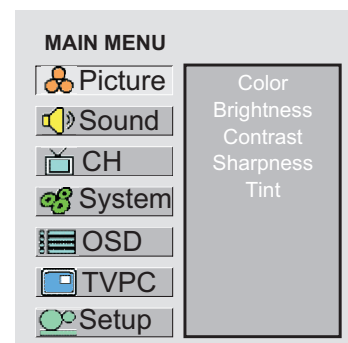

2 Use the **CH+/-** to select menu item. Use **VOL+/-** to adjust value of item. Use **Enter** to confirm, enter submenu or toggle the settings of the selected menu item. You can press the **Menu** button repeatedly to exit the menu operations.

Note:

To clearly introduce the menu operations, this operation manual provides a description based on operation with the remote control.

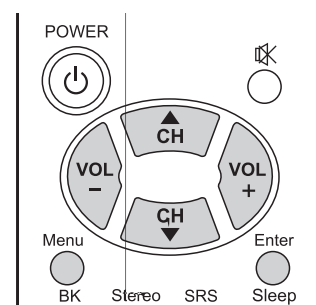

Displaying Status Information

Press the **Display** button on the remote control, the unit will display current status information such as channel number, audio mode or signal source, etc.

Memorizing the Channels

Your LCD TV can memorize and store all of the available channels for both antenna and cable channels. After the available channels are memorized, use CH+/- to scan through the channels.

Selecting the Signal Source

Before your LCD TV can memorize the available channels, you must specify the type of signal source that is connected to the unit. (i.e., an antenna or cable system)

- 1 Press **Menu** to display the menu main
- 2 Press **CH+/-** repeatedly to select **CH**.
- 3 Press **Enter** to access the submenu.
The **TV/Cable** menu item will be highlighted automatically.
- 4 Press **Enter** to toggle **TV** or **Cable**.
If you are connected to an antenna, please select TV. If you use cable, select cable.

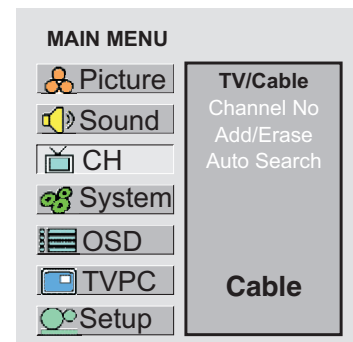
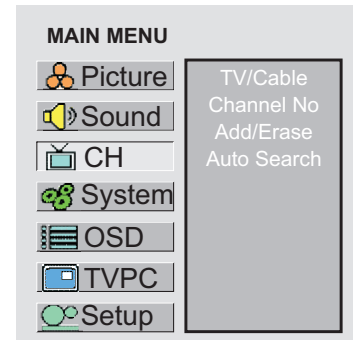

Storing Channels in Memory Automatically

- 1 Press **Menu** to display the menu main
- 2 Press **CH+/-** repeatedly to select **CH**.
- 3 Press **Enter** to access the submenu.
- 4 Press **CH-** repeatedly to highlight **Auto Search**.
- 5 Press **Enter** to store channels in memory automatically.
The unit will begin memorizing all of the available channels. During the process of the Auto Search, you can **Menu** to exit.

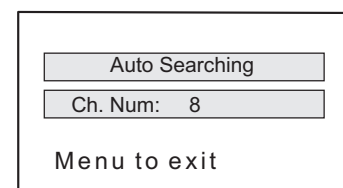
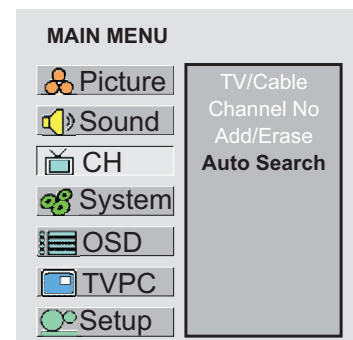

Memorizing the Channels (continued)

Adding and Erasing Channels

- 1 Press **Menu** to display the menu main
- 2 Press **CH+/-** repeatedly to select **CH**.
- 3 Press **Enter** to access the submenu.
- 4 Press **CH-** to highlight **Channel No**.
- 5 Press **VOL+/-** to select a channel number you want to add or erase.
You can also use number buttons to select a desired channel number
- 6 Press **CH-** to highlight **Add/Erase**.
- 7 Press **Enter** to toggle **Add** or **Erase**.

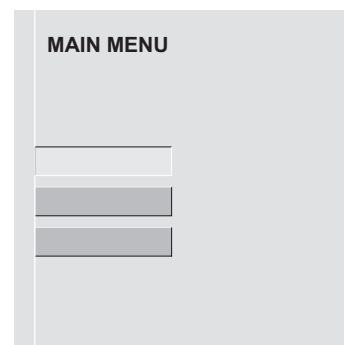
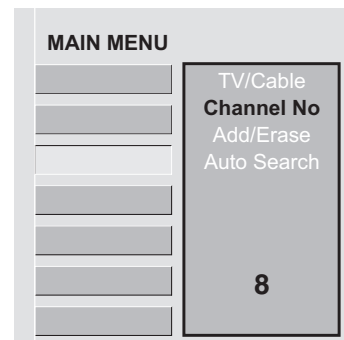

Changing Channels

Using the Channel Buttons (CH+ or CH-)

Press the **CH+** or **CH-** to change channels.

When you press the **CH+** or **CH-**, the unit changes channels in sequence. You will see all the channels that the unit has memorized.

You will not see channels that were erased.

Direct Accessing Channels

Press the **number buttons** to go directly to a channel.

To select a one-digit channel: press the **0-9 number buttons** to input the channel number and the unit automatically goes to the selected channel.

To select a two-digit channel: press the **0-9 number buttons** to input the channel number and the unit goes to the selected channel immediately.

To select a three-digit channel: press the **---** button to display "1--", then press the **0-9 number buttons** to input the remain two digits of the channel number, then the unit goes to the selected channel.

Note:

When you use the number buttons, you can directly select channels that were erased.

Using the Return button

Press this button to switch between the current channel and the previous channel.

Adjusting the Volume



Using the volume buttons (VOL+ and VOL-)

Press the **VOL +** or **VOL-** to increase or decrease the volume.

Using the Mute

Using the Mute button

At any time, you can temporarily cut off the sound using the Mute button.

- 1 Press the  button and the sound cuts off.
- 2 To turn mute off, press the  button again.

Basic Operations (continued)

Select Input Source Signal

- 1 Press the **Source**  button to access **Source Select** menu.
- 2 Press **CH+** or **CH-** to select a desired input source.
- 3 Press **Enter** to confirm and the unit displays a signal from the selected input source.

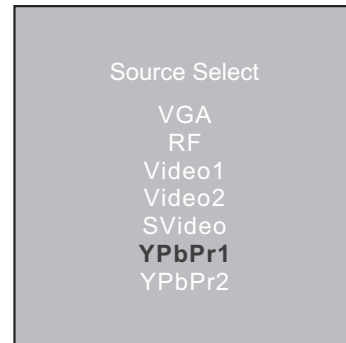

VGA ---Select signal from VGA (15-pin D-sub) jack.
RF-----Select TV signal.
Video1-----Select signal from AV1 IN terminals.
Video2-----Select signal from AV2 IN terminals.
SVideo-----Select signal from S-video terminal.
YPbPr1-----Select signal from YPbPr1.
YPbPr2-----Select signal from YPbPr2.

Selecting a Menu Language

- 1 Press **Menu** to display the menu main
- 2 Press **CH+/-** repeatedly to select **OSD**.
- 3 Press **Enter** to access the submenu.
The **Language** item will be highlighted automatically.
- 4 Press **Enter** to toggle between **English, French** and
- 5 Press **Menu** to exit.

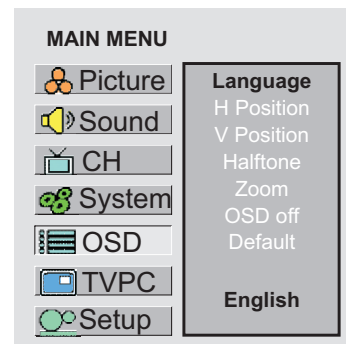

Customizing the Picture

- 1 Press **Menu** to display the menu main
The picture menu page will be displayed automatically.
- 2 Press **Enter** to access the **Picture** submenu.
- 3 Press **CH+/-** to select the item you wish to change.
- 4 Press **VOL+/-** to adjust the value of the item.
- 5 Press **Menu** to exit.

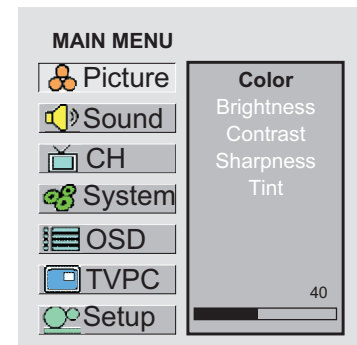

In TV/Video mode

Option	Function	Operation	Range
Color	Adjusts color saturation.	VOL+ deeper VOL- paler	0~100
Brightness	Adjusts screen brightness for easier viewing of dark picture such as night scenes and black hair.	VOL+ lighter VOL- darker	0~100
Contrast	Adjusts image contrast.	VOL+ stronger VOL- weaker	0~100
Sharpness	Adjusts image sharpness to display a sharp image.	VOL+ sharper VOL- softer	0~100
Tint	Adjusts tint for image.	VOL+ greenish VOL- purplish	0~100

In VGA mode

Option	Function	Operation	Range
Brightness	Adjusts screen brightness for easier viewing of dark picture such as night scenes and black hair.	VOL+ lighter VOL- darker	0~100
Contrast	Adjusts image contrast.	VOL+ stronger VOL- weaker	0~100
Sharpness	Adjusts image sharpness to display a sharp image.	VOL+ sharper VOL- softer	0~100
Color Temp	Adjusts preset color temperature.	Use Enter to toggle	6500K 9300K 12000K

Using the Preset Picture Mode

Use the **P.M** button to quickly select picture mode. There are three preset picture modes (**Bright**, **Soft** and **Nature**) and one user-set picture mode (**User**). Each preset mode has its own picture settings.
Bright: Select for a bright picture.
Soft: Select for a finely detailed picture.
Nature: Select for a normal picture.
 Adjusted settings are stored in User mode.

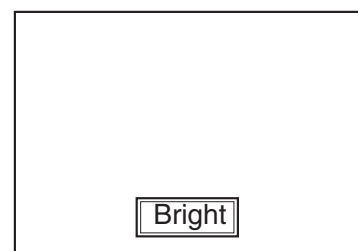

Setting System

Setting System In TV Mode

Adjusting Screen Aspect Ratio

- 1 Press **Menu** to display the menu main page.
- 2 Press **CH+/-** repeatedly to select **System**.
- 3 Press **Enter** to access the submenu.
The **Aspect Ratio** item will be highlighted automatically.
- 4 Press **Enter** repeatedly to select a desired aspect ratio.
You can select the image aspect ratio between **4:3**, **16:9**, **Panorama** and **Zoom**.
4:3 — For 4:3 signal format. This mode displays a 4:3 picture at its standard 4:3
16:9 — For 16:9 signal format. This mode displays 16:9 aspect ratio picture.
Panorama — In this mode the picture is progressively stretched toward each side of the screen. Use on most non-HDTV stations. **Pre-selected at the factory for your easier initial set-up.**
Zoom — For 4:3 letterbox signal format. This mode stretches the picture horizontally and crops the top and bottom black bars of the picture.

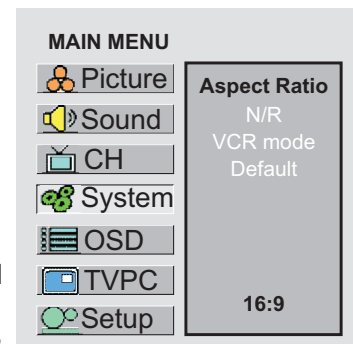

Note:

You may quickly select the screen aspect by using the **Screen** button on the remote control.

Reducing Picture Noise

- 1 Press **Menu** to display the menu main page.
- 2 Press **CH+/-** repeatedly to select **System**.
- 3 Press **Enter** to access the submenu.
- 4 Press **CH+/-** repeatedly to select **N/R**.
- 5 Press **Enter** to select **Off**, **Auto**, **Strong**, **Middle** or **Weak**.
Sometimes a grainy picture may appear on the screen because of poor signal. This function helps to enhance the picture quality by reducing the noise.

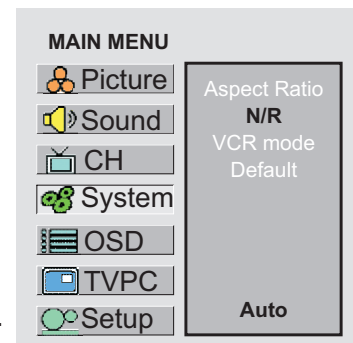

VCR mode

- 1 Press **Menu** to display the menu main page.
- 2 Press **CH+/-** repeatedly to select **System**.
- 3 Press **Enter** to access the submenu.
- 4 Press **CH+/-** repeatedly to select **VCR mode**.
- 5 Press **Enter** to select **On** or **Off**.

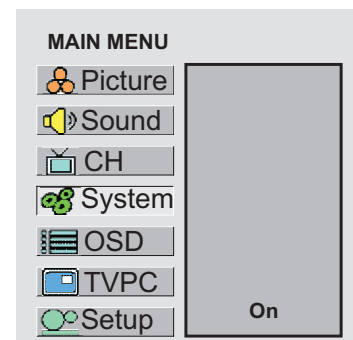

When you are watching VCR program or receiving a weak signal, set the "**VCR mode**" item to "**On**". It helps to obtain a better synchronization and improve the stability of the picture.

Loading Default Values

You may quickly load default values by using the **Default** item.

Setting System In VGA Mode

Changing the Position of Image

The unit allows you to adjust the position of the screen if it is not well-aligned.

- 1 Press **Menu** to display the menu main page.
- 2 Press **CH+/-** repeatedly to select **System**.
- 3 Press **Enter** to access the submenu.
- 4 Press **CH+/-** to select **H position** or **V position**.
- 5 Press **VOL+/-** to adjust the value of the item until the screen is well-aligned.

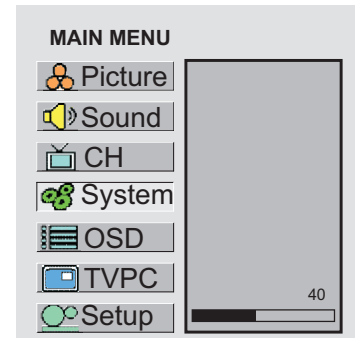

Adjusting Clock and Phase

- 1 Press **Menu** to display the menu main page.
- 2 Press **CH+/-** repeatedly to select **System**.
- 3 Press **Enter** to access the submenu.
- 4 Press **CH+/-** to select **Clock** or **Phase**.
- 5 Press **VOL+/-** to adjust the value of the item until the screen is well-aligned.

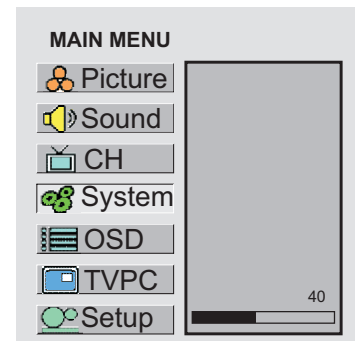

Adjust the clock frequency of the set's internal clock signal. If shimmering or rainbow-like noise is apparent in the image, try adjusting the clock frequency setting. You may find that images blur, depending on the clock phase of your PC's Processor. If you experience blurring ,

Adjusting the Picture Automatically

- 1 Press **Menu** to display the menu main page.
- 2 Press **CH+/-** repeatedly to select **System**.
- 3 Press **Enter** to access the submenu.
- 4 Press **CH+/-** repeatedly to select **Auto Adjust**.
- 5 Press **Enter** to confirm.

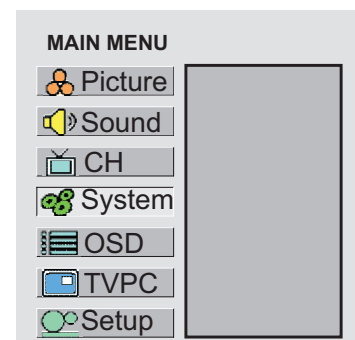

You may quickly adjust the picture by using the **Auto** button directly. The unit automatically adjusts phase, clock or position, etc. The Auto Adjust function only works when the picture is displayed in 16:9 with full screen.

Setting System (continued)

Setting System In VGA Mode(continued)

Adjusting Screen Aspect

- 1 Press **Menu** to display the menu main page.
- 2 Press **CH+/-** repeatedly to select **System**.
- 3 Press **Enter** to access the submenu.
- 4 Press **CH+/-** repeatedly to highlight **Aspect Ratio**.
- 5 Press **Enter** repeatedly to select **4:3** or **16:9**.

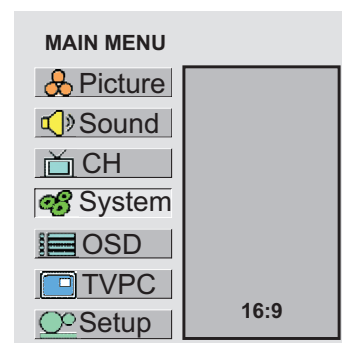

Note:

You may quickly select the screen aspect by using the **Screen** button on the remote

Display Resolution Information

You may quickly display the resolution information by using the **Resolution** item.

Loading Default Values

You may quickly load default values by using the **Default** item.

Setting System In YPbPr (Component Video) Mode

Adjusting Phase

- 1 Press **Menu** to display the menu main page.
- 2 Press **CH+/-** repeatedly to select **System**.
- 3 Press **Enter** to access the submenu.
The **Phase** item will be highlighted automatically.
- 4 Press **VOL+/-** repeatedly to adjust the value for clearest picture.

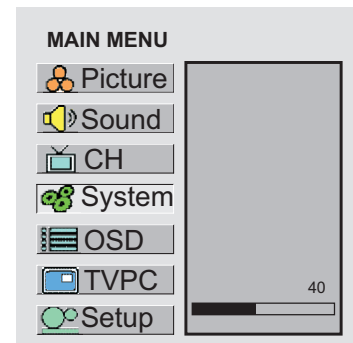

Adjusting Screen Aspect

- 1 Press **Menu** to display the menu main page.
- 2 Press **CH+/-** repeatedly to select **System**.
- 3 Press **Enter** to access the submenu.
- 4 Press **CH+/-** repeatedly to highlight **Aspect Ratio**.
- 5 Press **Enter** repeatedly to select a desired aspect ratio.

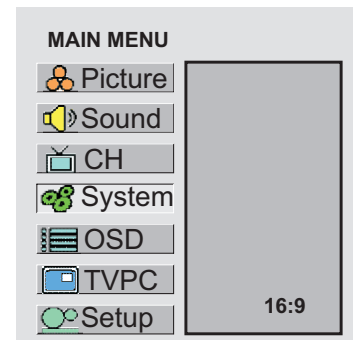

For 480i or 480P signal format, you can select the image aspect ratio between **4:3**, **16:9**, **Panorama** and **Zoom**. Use 16:9 for HDTV and most DVD titles. (Change from the factory pre-selected Panorama setting.)

For 720P or 1080i signal format, you can select the image aspect ratio between **4:3** and **16:9**.

Note:

You may quickly select the screen aspect by using the **Screen** button on the remote

Reducing Picture Noise

- 1 Press **Menu** to display the menu main page.
- 2 Press **CH+/-** repeatedly to select **System**.
- 3 Press **Enter** to access the submenu.
- 4 Press **CH+/-** repeatedly to select **N/R**.
- 5 Press **Enter** repeatedly to select **Off**, **Auto**, **Strong**, **Middle** or **Weak**.

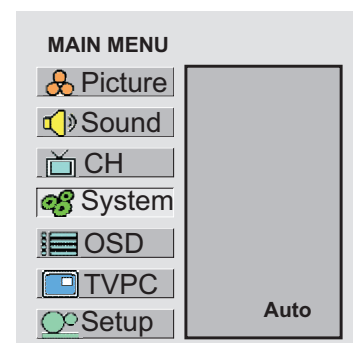

Loading Default Values

You may quickly load default values by using the **Default** item.

Setting Sound

Customizing the Sound

- 1 Press **Menu** to display the menu main page.
- 2 Press **CH+/-** repeatedly to select **Sound**.
- 3 Press **Enter** to access the submenu.
- 4 Press **CH+/-** repeatedly to select the option items you want to adjust.
- 5 Press **VOL+/-** to adjust the value or **Enter** to toggle settings.

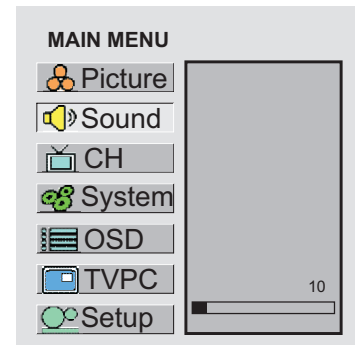

Option	Function	Operation	Range
Volume	Adjusts volume value	VOL+ stronger VOL- weaker	0~100
Bass	Adjusts Bass (low sounds)	VOL+ stronger VOL- weaker	0~100
Treble	Adjusts Treble (high sounds)	VOL+ stronger VOL- weaker	0~100
Balance	Adjusts volume balance (left and right)	VOL+ Higher volume from right speaker. VOL- Higher volume from left speaker.	0~100
Mute	Mutes the sound	Use Enter to toggle	On or Off
Speaker	Turns speaker sound output on or off	Use Enter to toggle	On or Off
Head Phone	Turns headphone sound output on or off	Use Enter to toggle	On or Off

Using the Preset Sound Mode

Use the **S.M** button to quickly select sound mode. There are three preset sound modes (**Movie**, **Music** and **News**) and one user-set sound mode (**User**). Each preset mode has its own sound settings (Bass and Treble).

Movie: Select for a movie program.

Music: Select for a music program.

News: Select for a speech or conversation program.



Setting SRS effect

Use the **SRS** button to quickly turn the SRS effect on or off.

SRS (Sound Retrieval System®) is an audio enhancement technology that restores the spatial cues that are present in a live listening environment and processes it to provide a natural 3D sound field.

* The SRS symbol is a trademark of SRS Labs, Inc.
SRS technology is incorporated under license from SRS Labs, Inc.

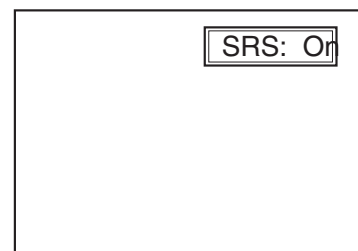

Note:

When the **SRS** effect is set to **On**, the **SRS** function may affect the setting of the **Balance** function.

Adjusting On-Screen Display

Adjusting OSD Position

- 1 Press **Menu** to display the menu main
- 2 Press **CH+/-** repeatedly to select **OSD**.
- 3 Press **Enter** to access the submenu.
- 4 Press **CH+/-** repeatedly to select **H Position** or **V Position**.
- 5 Press **VOL+/-** to adjust the OSD position.

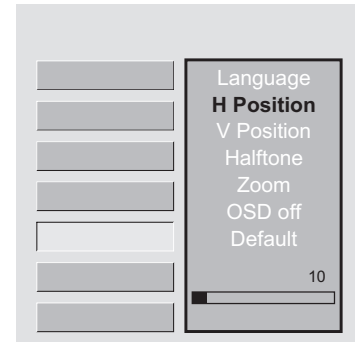

Adjusting OSD Transparency

- 1 Press **Menu** to display the menu main
- 2 Press **CH+/-** repeatedly to select **OSD**.
- 3 Press **Enter** to access the submenu.
- 4 Press **CH+/-** repeatedly to select **Halftone**.
- 5 Press **VOL+/-** to adjust the OSD transparency.

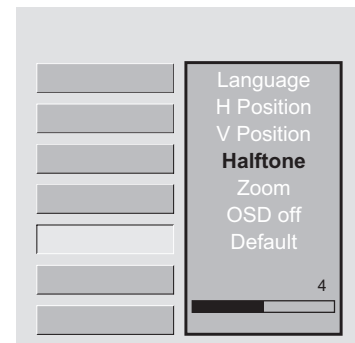

Zooming OSD Menu

- 1 Press **Menu** to display the menu main
- 2 Press **CH+/-** repeatedly to select **OSD**.
- 3 Press **Enter** to access the submenu.
- 4 Press **CH+/-** repeatedly to select **Zoom**.
- 5 Press **Enter** repeatedly to select **Normal** or **Zoom**.

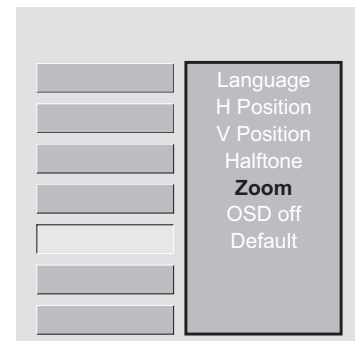

Setting OSD Off Time

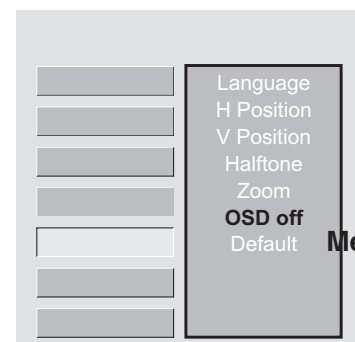

Menu to display

PIP Operations (Not on all models)

Viewing the Picture-in-Picture

The **TVPC** function is available only when the main frame is in **VGA (computer)** mode and the vertical frequency is 60 Hz.

- 1 Press **Menu** to display the menu main page.
- 2 Press **CH+/-** repeatedly to select PIP.
- 3 Press **Enter** to access the submenu.
The PIP **On/Off** item will be highlighted automatically.
- 4 Press **Enter** to select **On** or **Off**.

Note:

- 4 You may quickly open or close PIP frame by directly by using the PIP button.
- 4 Audio is from the main picture only.

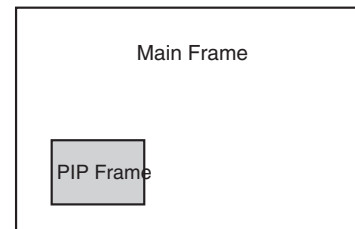
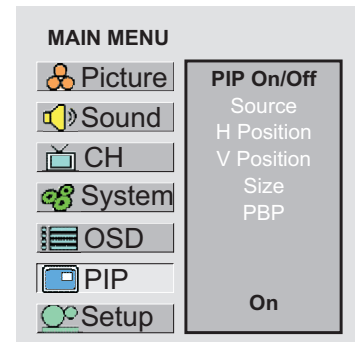

Selecting the Signal Source for the PIP Frame

- 1 Press **Menu** to display the menu main page.
- 2 Press **CH+/-** repeatedly to select PIP.
- 3 Press **Enter** to access the submenu.
- 4 Press **CH+/-** repeatedly to select **Source**.
- 5 Press **Enter** repeatedly to select signal source for the PIP frame.
You may select **RF**, **Video1**, **Video2**, **SVideo** or **YPbPr** for the PIP Frame.

Note:

You may quickly select signal source for the PIP frame by using the **P.S.**

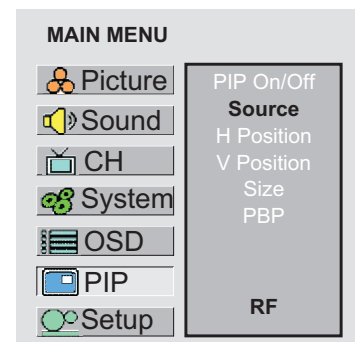

Changing Channels for the PIP Frame

When the PIP frame is in TV mode, press the **up** or **down** button to change channels.

When you press the **up** or **down**, the unit changes channels in sequence. You will see all the channels that the unit has memorized.

You will not see channels that were erased.

PIP Operations (continued)

Changing the Position of the PIP Frame

- 1 Press **Menu** to display the menu main page.
- 2 Press **CH+/-** repeatedly to select PIP.
- 3 Press **Enter** to access the submenu.
- 4 Press **CH+/-** repeatedly to select **H Position** or **V Position** item.
- 5 Press **VOL+/-** to adjust the PIP frame position.

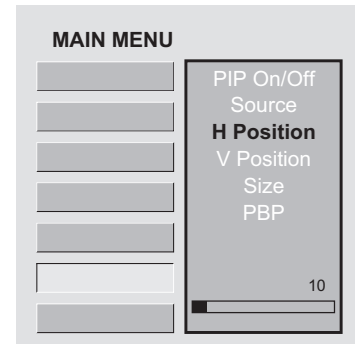

Note:

You can quickly adjust PIP position by using the **POS** button.

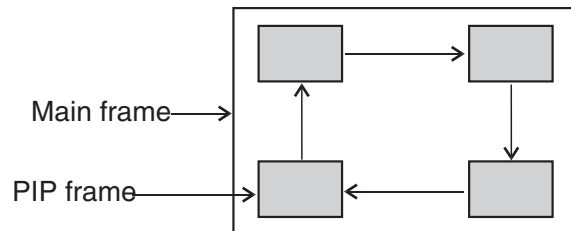

Adjusting the Size of PIP Frame

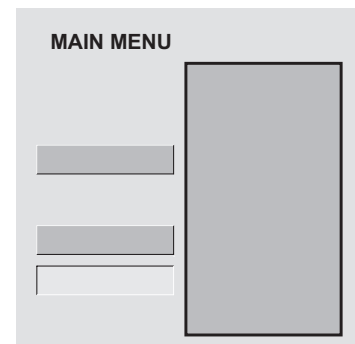

Note:

You may quickly adjust PIP size by using the **Size** button.

Using Hotkeys

Setting Sleep Timer

Press the **Sleep** button repeatedly to set a sleep time to automatically turn off the unit. Each press of the button, the value changes as below.

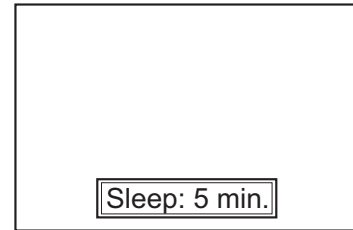
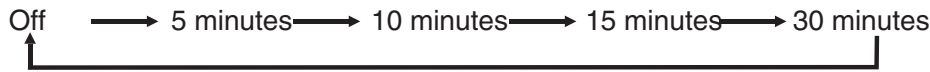

Setting Audio Mode

Press the **Stereo** button repeatedly to select the audio mode between **MONO**, **SAP** and **STEREO**.

Choose **STEREO** for channels that are broadcasting in stereo.

Choose **MONO** for channels that are broadcasting in mono, or if you are having difficulty receiving a stereo signal.

Adjusting Back Light of the Panel

Press the **BK** button repeatedly to select the back light of the panel. There are 4 levels of the back light for adjustment.

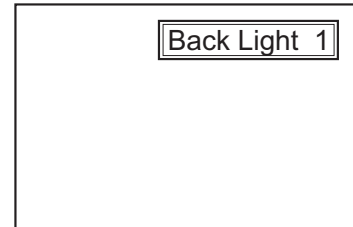

Freezing the Picture

Press the **Still** button to hold on the image on the screen (the video sources still run). Press again to reactivate the image.

Note:

The freeze function works in TV, Video or S-video mode only.

For the sake of protecting the screen, please do NOT freeze a picture for a long time. "Burn-in" damage is not covered by warranty.

Viewing Closed Captions

The unit decodes and displays the closed captions that are broadcast with certain TV shows. These captions are usually subtitles for the hearing impaired or foreign language translations. All VCRs record the closed caption signal from television programs, so home-recorded video tapes also provide closed captions. Most prerecorded commercial video tapes provide closed captions as well. Check for the closed caption symbol in your television schedule and on the tape's packaging: .

Note:

The Caption feature does not work with YPbPr, VGA.

Not all the programs and videos will offer closed captioning. Please look for the  symbol to ensure that captions will

Turning Closed Caption On or Off

- 1 Press **Menu** to display the menu main page.
- 2 Press **CH+/-** repeatedly to select **Setup**.
- 3 Press **Enter** to access the submenu.
The **CCD On/Off** item will be highlighted automatically.
- 4 Press **Enter** to select **On** or **Off**.

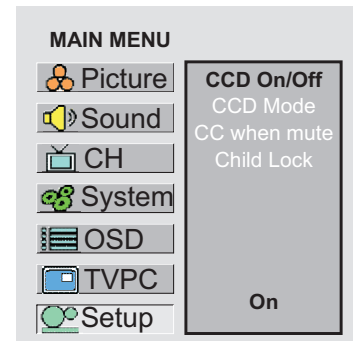

Setting Closed Caption

- 1 Press **Menu** to display the menu main page.
- 2 Press **CH+/-** repeatedly to select **Setup**.
- 3 Press **Enter** to access the submenu.
- 4 Press **CH+/-** repeatedly to select **CCD mode**.
- 5 Press **Enter** repeatedly to select a desired mode.

You may select between CC-1, CC-2, CC-3, CC-4, T-1, T-2, T-3 and T-4.

The Closed Caption broadcasts can be viewed in two modes: CAPTION and TEXT. For each mode, four channels are available.

The [CAPTION] mode shows subtitles of dialogues and commentaries of TV dramas and news programs while allowing a clear view of the picture.

The [TEXT] mode displays various information over the picture (such as TV program schedule, weather forecast, etc.) that is independent of the TV programs.

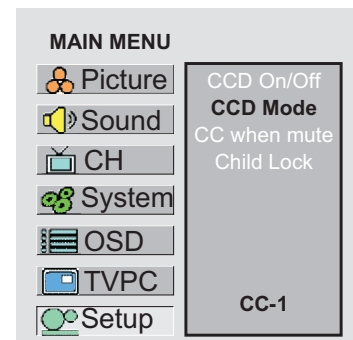

Note:

You may quickly select CCD mode by using the **CCD** button directly.

Setting CC When Mute

- 1 Press **Menu** to display the menu main page.
 - 2 Press **CH+/-** repeatedly to select **Setup** item.
 - 3 Press **Enter** to access the submenu.
 - 4 Press **CH+/-** repeatedly to select **CC when mute** item.
 - 5 Press **Enter** to select **On** or **Off**.
- If you set this item to **On**, the unit display closed caption when you mute the sound.

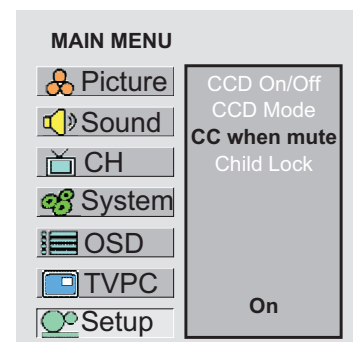

Adjusting Child Lock Settings (Not on all models)

Child Lock

This function allows TV programs to be restricted and TV usage to be controlled based on U.S.A. FCC and Canadian data. It prevents children from watching violent or sexual scenes that may be harmful. Restriction of TV programs includes two ratings that contain information about the program: the MPAA rating and the TV Parental Guidelines. The MPAA rating is restricted by age. TV Parental Guidelines are restricted by age and content. Since a TV program may use either the MPAA rating or the TV Guidelines, both should be adjusted for complete control.

[1] Movie Rating (MPAA)

Rating		
age based	G	GENERAL AUDIENCES. All ages admitted.
	PG	PARENTAL GUIDANCE SUGGESTED. Some material may not be suitable for children.
	PG-13	PARENTAL STRONGLY CAUTIONED. Some material may be inappropriate for children under 13.
	R	RESTRICTED. Under 17 requires accompanying parent or adult guardian.
	NC-17	NO ONE 17 AND UNDER ADMITTED.
	X	X Rating is an older rating that is unified with NC-17 but may be encoded in the data of older movies.
	N/A	NOT RATED

Note:
The Movie rating is only age-based.

Example 1:

“PG-13” in the age-based rating is blocked, this will automatically block the higher ratings “R”, “NC-17”, “X” also.

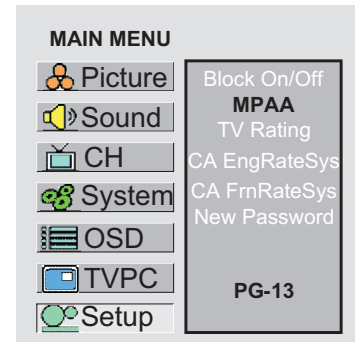

Example 2:

“R” in the age-based rating is blocked, this will automatically block the higher rating “NC-17”, “X” also.

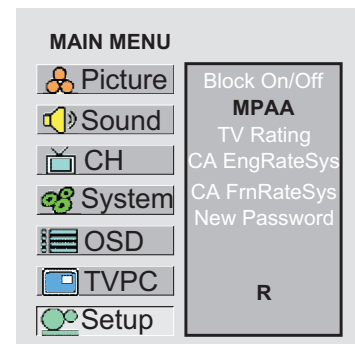

“Child Lock Block” with a green screen will be displayed if you watch the program with Program Rating data the same as you configured.

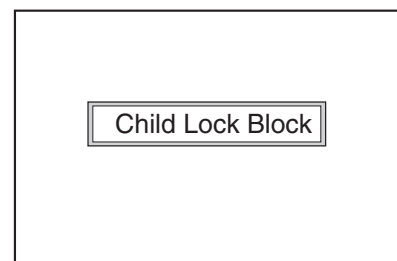

Adjusting Child Lock Settings (continued)

[2] TV Rating

Rating		← content based →				
		D	L	S	V	FV
age based	TV-Y (All children)	×	×	×	×	×
	TV-Y7 (Direct to Older Children)	×	×	×	×	●
	TV-G (General Audience)	×	×	×	×	
	TV-PG (Parental Guidance Suggested)	●	●	●	●	
	TV-14 (Parents Strongly Cautioned)	●	●	●	●	
	TV-MA (Mature Audience Only)		●	●	●	

× — Content Rating can be set but this Rating is not normally broadcast by TV Station.

● — Content Rating can be set.

D: Sexually Suggestive Dialog
 L: Adult Language
 S: Sexual Situation
 V: Violence
 FV: Fantasy Violence

Note:

Age-based ratings can be modified by the content-based ratings but only in the combinations indicated by an ● in the table above.

Example 1:

When TV-Y7 in the age-based rating is set to BLOCK, this will automatically block the higher ratings: TV-G, TV-PG, TV-14 and TV-MA. In addition, D, L, S, V and FV in content are automatically blocked.

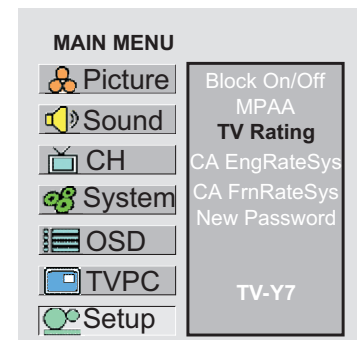

Example 2:

When TV-14 in the age-based rating is set to BLOCK, this will automatically block the higher ratings: TV-MA. In addition, if you block "L" sub-rating in TV-PG, then the D, L, S, V and FV in content in TV-14 and TV-MA will automatically be blocked.

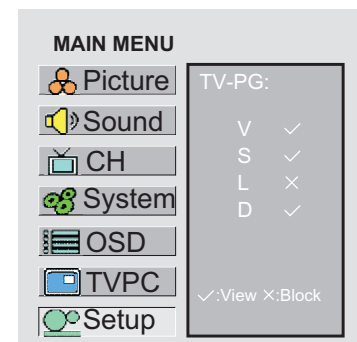

"Child Lock Block" with a green screen will be displayed if you watch the program with Program Rating data the same as you configured.

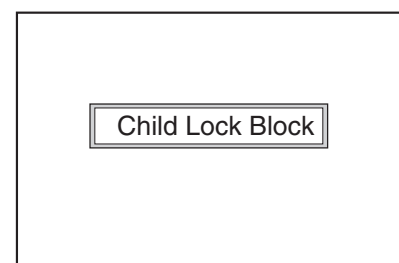

Adjusting Child Lock Settings (continued)

Turning Child Lock On or Off

- 1 Press the **Menu** button to display the menu main page.;
- 2 Press **CH+/-** repeatedly to select **Setup** item;
- 3 Press **Enter** to access the submenu;
- 4 Enter password with the **number buttons**.
The default password is 1234, you can change the password by yourself. The unit allows you to access the Child Lock menu if you input the right password, or you will be denied.

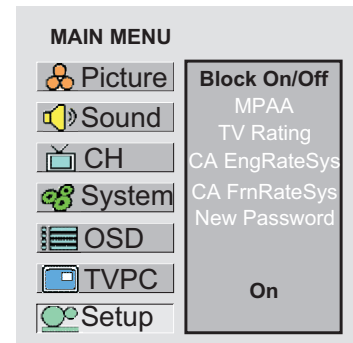

- 5 Press **Enter** to turn on or off the Child Lock.

Changing the Password

- 1 From the password menu page, press **CH+/-** repeatedly to select **New Password** item.
- 2 Input a new 4-digit password. For example, you may set "0000" as your new password.
- 3 Press the **Menu** button to exit.
Be sure to write down your password and retain it for future use. The unit provides a master password "8888". If you forget your password and can't access Child Lock menu, you may input the master password to access Child Lock menu. Please set a new password and make sure to remember your password.

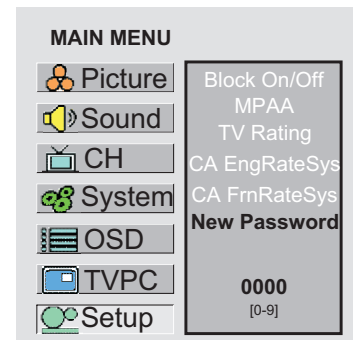

Adjusting the Movie Rating

- 1 From the **Child Lock** menu page, press **CH+/-** repeatedly to select **MPAA**
- 2 Press **Enter** repeatedly to select a desired rating you want to block.
For example, "PG-13" in the age-based rating is selected, this will automatically block the higher ratings "R", "NC-17", "X" also.
- 3 Press the **Menu** button to exit.

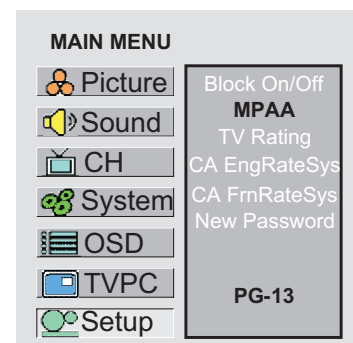

Adjusting the TV Rating

- 1 From the **Child Lock** menu page, press **CH+/-** repeatedly to select **TV Rating** item.
- 2 Press **Enter** repeatedly to select a desired rating you want to block.
This will automatically block the higher age-based ratings. You may set the individual content-based ratings as follows:
- 3 Press **VOL+/-** to set content-based ratings.
- 4 Press **CH+/-** repeatedly to select a desired content rating.
- 5 Press **Enter** to block (X) or unblock (✓) this rating.
- 6 Press **Menu** repeatedly to exit.

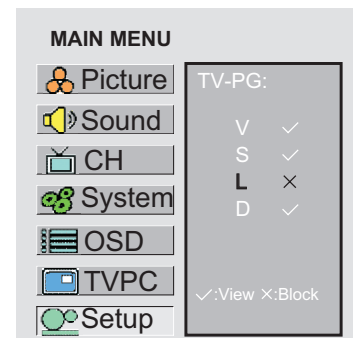
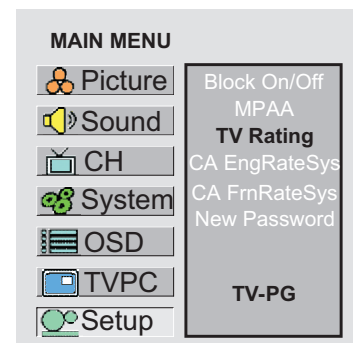

Adjusting Child Lock Settings (continued)

Adjusting Canadian English Rating

- 1 From the **Child Lock** menu page, press **CH+/-** repeatedly to select **CA EngRateSys** item.
- 2 Press **Enter** repeatedly to select a desired rating you want to block.
- 3 Press the **Menu** button to exit.

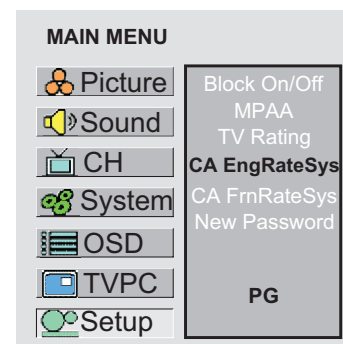

CANADIAN ENGLISH RATING CHART

E	Exempt - Exempt programming includes: news, sports, documentaries and other information programming, talk shows, music videos, and variety programming.
C	Programming intended for children under age 8. No offensive language, nudity or sexual content.
C8+	Programming generally considered acceptable for children 8 years and over. No profanity, nudity or sexual content.
G	General programming, suitable for all audiences.
PG	Parental Guidance suggested. Some material may not be suitable for children.
14+	Programming contains themes or content which may not be suitable for viewers under the age of 14. Parents are strongly cautioned to exercise discretion in permitting viewing by pre-teens and
18+	Intended for viewers 18 years and older and might contain depictions of violence.

Adjusting Canadian French Rating

- 1 From the **Child Lock** menu page, press **CH+/-** repeatedly to select **CA FrnRateSys** item.
- 2 Press **Enter** repeatedly to select a desired rating you want to block.
- 3 Press the **Menu** button to exit.

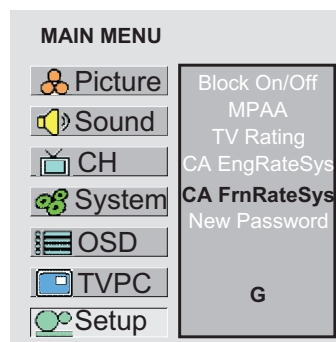

CANADIAN FRENCH RATING CHART

E	Exempt - Exempt
G	General - Programming intended for audience of all ages. Contains no violence, or the violence content is minimal or is depicted appropriately.
8 ANS+	8+ General - Not recommended for young children. Programming intended for a broad audience but contains light or occasional violence. Adult supervision recommended.
13 ANS+	Programming may not be suitable for children under the age of 13 - Contains either a few violent scenes or one or more sufficiently violent scenes to affect them. Adult supervision strongly suggested.
16 ANS+	Programming may not be suitable for children under the age of 16 - Contains frequent scenes of violence or intense violence.
18 ANS+	Only for adult viewing. Could contain frequent violent scenes and extreme violence.

Troubleshooting

Before calling for repair service, check the following items for possible remedies to the encountered symptoms.

Symptoms	Check item
"Ghost" or double images	! This may be caused by obstruction to the antenna due to high rise buildings or hills. Using a highly directional antenna may improve the
No power	! Check that the AC power cord is plugged into the mains socket. ! Unplug the power cord, wait for 60 seconds. Then re-insert plug into the mains socket and turn on the unit again.
No picture	! Check antenna connections at the rear of the unit to see if it is properly connected to the unit. ! Possible broadcast station trouble. Try another channel. ! Adjust the contrast and brightness settings. ! Check the Closed Captions control. Some TEXT modes could block the screen. ! Select a correct input. ! Is a non-compatible signal being input?
Good picture but no sound	! Increase the VOLUME. ! Check that the unit is not muted. ! Check that the Speaker item in SOUND menu is set to ON.
Good sound but poor color	• Adjust the contrast, color and brightness
Poor picture	! Sometimes, poor picture quality occurs when having activated an S-VHS camera or camcorder connected and having connected another peripheral at the same time. In this case, switch off one of the other peripherals. ! Check whether the room is too bright
Horizontal dotted line	! This may be caused by electrical interference (e.g. hairdryer, nearby neon lights, etc.) ! Turn off the equipment.
Television not responding to remote control	! Check whether the batteries are working. Replace if necessary. ! Clean the remote control sensor lens on the unit. ! Do not use the remote control under strong or fluorescent lighting. ! The batteries should be inserted with polarity (+, -) aligned.
Snowy picture and noise	! Check the antenna connection.
No stable or not synchronized VGA picture	! Check if you have selected the correct VGA mode in your PC.
No output from one of the speakers	! Adjust Balance in the SOUND menu.

Note:

If your problem is not solved, turn your unit off and then on again once. Never attempt to repair a defective unit yourself.

Type	TFT LCD	PLASMA
Display Size diagonal	40"/32"/27"	42"
Display Feature		
Resolution	1280 x 720	1024 x 768
Pixel Pitch	0.51 mm	0.81 x 0.81 mm
Maximum Colors	16,777,216	16,700,000
Brightness	500 nit	1000 nit
Contrast	500:1	3000:1
Viewing Angle	170°/170°	170°/170°
Response Time	20ms/20ms/16ms	not applicable
TV Tuner & Color System		
Tuner	FST x 1	FST x 1
TV System	America NTSC Standard Color	America NTSC Standard Color
Channel Coverage	VHF 2-13, UHF 14-69, CATV (1-125)	VHF 2-13, UHF 14-69, CATV (1-125)
Video Features	Progressive Scan and Interlace	Progressive Scan and Interlace
Audio Speaker System		
Maximum Audio Output	10Wx2/10Wx2/7Wx2	10Wx2
Stereo Sound System	BTSC	BTSC
Power Supply	AC110V-240V 50/60Hz	AC110V-240V 50/60Hz
Power Consumption	180W/180W/140W	400W
Stand by Mode Power Consumption	<1W	<1W
Unit weight (lb)	82/44/35	85
Other functions	Picture in Picture (video graphic only)	Picture in Picture (video graphic only)
	Sleep Timer (Off only)	Sleep Timer (Off only)
	Picture Freeze (TV and AV only)	Picture Freeze (TV and AV only)
Caption	Closed Caption	Closed Caption
Security	Child Lock	Child Lock
Remote Control function support for full OSD features	OSD Support for English, French, Spanish	OSD Support for English, French, Spanish

Specification (continued)

Terminals	
Video In	RF : TV/CATV 75ohms coaxial x 1
	AV : RCA 75ohms composite video x 2
	S-Video : 4-pin DIN x 1
	D-Sub 15 x 1
	YPbPr/YCbCr (Support HDTV): RCA for DVD, STB x2
Video Out	RCA 75 ohms x 1
Audio In	L/R RCA for AV x2
	Stereo mini phone Jack for PC x 1
	L/R RCA for YPbPr/YCbCr x2
Audio Out	L/R RCA for Video Out x 1 Headphone Jack : Stereo mini phone Jack x 1
Accessories	1 User Manual 1 Remote Control 1 Power Cord 2 AAA Batteries 1 Component-Video Cable (YPbPr/YCbCr), 1 Audio/Video Cable
Display Format Supported by This Unit	
For VGA: 640X480 @ 60Hz,72Hz,75Hz,85Hz;	800X600 @ 60Hz,72Hz,75Hz,85Hz;
1024X768 @ 60Hz,75Hz,85Hz;	1280X960 @ 60Hz;
1280X1024 @ 60Hz.	
For YPbPr: 480P @ 60Hz;	480i @ 60Hz;
720P @ 60Hz;	
1080i @ 60Hz.	

SANYO COMFORT WARRANTY

WARRANTY APPLICATION

New, unused Sanyo Color Television products purchased in Canada through a Sanyo authorized dealer are warranted against manufacturing defects in materials and workmanship for ONE YEAR for parts and labor, from the date of purchase by the original retail purchaser for non-commercial use. This warranty only applies in favor of the original retail purchaser of the warranted product.

SANYO CANADA INC.'S RESPONSIBILITY

During the warranty period, SANYO Canada Inc. will repair, or at our option, replace a Color Television product which shows evidence of a manufacturing defect in materials or workmanship.

Replacement PARTS are warranted for the remaining portion of the warranty period.

WHAT IS NOT COVERED

- (a) Color Television products purchased outside Canada.
- (b) Color Television products purchased in a used condition.
- (c) Problems due to product set-up and installation.
- (d) Adjustments that are outlined in the Operating Manual.
- (e) Accessory items including antenna, batteries and connecting cables.
- (f) Damage in or due to transportation.
- (g) Damage due to improper maintenance, accident, abuse, misuse or negligence.
- (h) Damage caused by lightning and power surges.

ORIGINAL RETAIL PURCHASER'S RESPONSIBILITY

You, the original retail purchaser, must present your original, dated bill-of-sale together with this warranty to SANYO Canada Inc. or to an authorized Sanyo Service Depot* when you make a claim under this warranty.

You, the original retail purchaser, are responsible for any costs of TRANSPORTING the product to and from SANYO Canada Inc. or an authorized Sanyo Service Depot. You also are responsible for the cost of any MAINTENANCE necessary in respect of the product.

*In-home service is only available to the units whose screen size is 25 inches or over, and limited to the locations within a 30-km radius of any authorized Sanyo Service Depot, throughout Canada.

WARRANTY BECOMES VOID This warranty becomes void if the product's serial numbers are altered or removed or if any repair to the product is made other than by SANYO Canada Inc. or by an authorized Sanyo Service Depot.

LIMITATIONS

- (a) SANYO Canada Inc. reserves the right to change or improve the design of the model of the product warranted hereunder without incurring any obligation to make any modifications to or to install any improvement in or on the product.
- (b) In no event shall SANYO Canada Inc. or any of its Authorized Dealers be liable for special or consequential damage arising from the use of this product.

STATUTORY WARRANTIES

The above provisions do not preclude the operation of any applicable provincial statute which in certain circumstances may not allow some of the limitations and exclusions described in this Warranty. Where any terms of this Warranty are prohibited by such a statute, they shall be deemed null and void but the remainder of this warranty shall remain in effect.

HOW TO OBTAIN WARRANTY SERVICE

Please contact the Sanyo Authorized Dealer from whom the product was purchased or contact us directly at:

SANYO Canada Inc.
300 Applewood Cres.
Concord Ont. L4K 5C7
(905) 760-9944
1-800-263-2244



**PRINTED ON
RECYCLED PAPER**

604-L27K67-01

Free Manuals Download Website

<http://myh66.com>

<http://usermanuals.us>

<http://www.somanuals.com>

<http://www.4manuals.cc>

<http://www.manual-lib.com>

<http://www.404manual.com>

<http://www.luxmanual.com>

<http://aubethermostatmanual.com>

Golf course search by state

<http://golfingnear.com>

Email search by domain

<http://emailbydomain.com>

Auto manuals search

<http://auto.somanuals.com>

TV manuals search

<http://tv.somanuals.com>