



LCD TV

MODEL LCD-19E30A

LCD-26E30A

LCD-32E30A

LCD-42E30FA

Owner's Manual

TO THE OWNER

Before operating this LCD TV, read this manual thoroughly and operate the LCD TV properly.

This LCD TV provides many convenient features and functions. Operating the LCD TV properly enables you to manage those features and maintains it in better condition for a considerable time.

Improper operation may result in not only shortening the product-life, but also malfunctions, fire hazard, or other accidents.

If your LCD TV seems to operate improperly, read this manual again, check operations and cable connections and try the solutions in the "Troubleshooting" section on page 40 of this booklet. If the problem still persists, contact the dealer where you purchased the LCD TV or the service center.



Safety Precaution

WARNING : TO REDUCE THE RISK OF FIRE OR ELECTRIC SHOCK, DO NOT EXPOSE THIS APPLIANCE TO RAIN OR MOISTURE.

- Install the LCD TV in a proper position. If not, it may result in a fire hazard.
- Provide appropriate space on the top, sides and rear of the LCD TV cabinet for allowing air circulation and cooling the LCD TV.
- Minimum clearance must be maintained. If the LCD TV is to be built into a compartment or similarly enclosed, the minimum distances must be maintained. Do not cover the ventilation slot on the LCD TV. Heat build-up can reduce the service life of your LCD TV, and can also be dangerous.
- If the LCD TV is not to be used for an extended time, unplug the LCD TV from the power outlet.

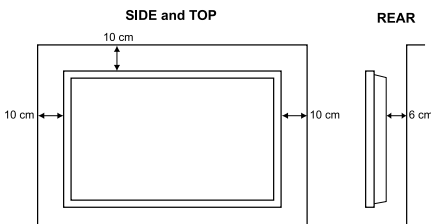

READ AND KEEP THIS OWNER'S MANUAL FOR LATER USE.

Caution In Installing

- Handle the LCD TV carefully when installing it and do not drop.
- Locate set away from heat, excessive dust, and direct sunlight.
- For correct installation and mounting it is strongly recommended to use a trained, authorized dealer. Failure to follow correct mounting procedures could result in damage to the equipment or injury to the installer.

NOTE :

When LCD TV is not used for a long period of time, unlighted dots may be observed. This is caused by characteristic of the LCD TV. If this occurs, turn the LCD TV on and leave it on about 1 hour. These dots will gradually disappear.

	CAUTION RISK OF ELECTRIC SHOCK DO NOT OPEN	
CAUTION : TO REDUCE THE RISK OF ELECTRIC SHOCK, DO NOT REMOVE COVER (OR BACK). NO USER-SERVICEABLE PARTS INSIDE. REFER SERVICING TO QUALIFIED SERVICE PERSONNEL.		
	THIS SYMBOL INDICATES THAT DANGEROUS VOLTAGE CONSTITUTING A RISK OF ELECTRIC SHOCK IS PRESENT WITH THIS UNIT.	
		THIS SYMBOL INDICATES THAT THERE ARE IMPORTANT OPERATING AND MAINTENANCE INSTRUCTIONS IN THE OWNER'S MANUAL WITH THIS UNIT.



SAFETY INSTRUCTIONS

All the safety and operating instructions should be read before the product is operated.

Read all of the instructions given here and retain them for later use. Unplug this LCD TV from AC power supply before cleaning. Do not use liquid or aerosol cleaners. Use a damp cloth for cleaning.

Follow all warnings and instructions marked on the LCD TV.

For added protection to the LCD TV during a lightning storm, or when it is left unattended and unused for long periods of time, unplug it from the wall outlet. This will prevent damage due to lightning and power line surges.

Do not expose this unit to rain or use near water...for example, in a wet basement, near a swimming pool, etc...

Do not use attachments not recommended by the manufacturer as they may cause hazards.

Do not place this LCD TV on an unstable cart, stand, or table. The LCD TV may fall, causing serious injury to a child or adult, and serious damage to the LCD TV. Use only with a cart or stand recommended by the manufacturer, or sold with the LCD TV. Wall or shelf mounting should follow the manufacturer's instructions, and should use a mounting kit approved by the manufacturers.

An appliance and cart combination should be moved with care. Quick stops, excessive force, and uneven surfaces may cause the appliance and cart combination to overturn.

Slots and openings in the back and bottom of the cabinet are provided for ventilation, to insure reliable operation of the equipment and to protect it from overheating.



The openings should never be covered with cloth or other materials, and the bottom opening should not be blocked by placing the LCD TV on a rug, or other similar surface. This LCD TV should never be placed near or over a radiator or heat register.

This LCD TV should not be placed in a built-in installation such as a book case unless proper ventilation is provided.

Never push objects of any kind into this LCD TV through cabinet slots as they may touch dangerous voltage points or short out parts that could result in a fire or electric shock. Never spill liquid of any kind on the LCD TV.

Do not place items such as vases containing liquid on top of the LCD TV.

Do not install the LCD TV near the ventilation duct of air-conditioning equipment.

This LCD TV should be operated only from the type of power source indicated on the marking label. If you are not sure of the type of power supplied, consult your authorized dealer or local power company.

Do not overload wall outlets and extension cords as this can result in fire or electric shock. Do not allow anything to rest on the power cord. Do not locate this LCD TV where the cord may be damaged by persons walking on it.

Do not attempt to service this LCD TV yourself as opening or removing covers may expose you to dangerous voltage or other hazards. Refer all servicing to qualified service personnel.

Unplug this LCD TV from wall outlet and refer servicing to qualified service personnel under the following condition:

- a. When the power cord or plug is damaged or rayed.
- b. If liquid has been spilled into the LCD TV.
- c. If the LCD TV has been exposed to rain or water.
- d. If the LCD TV does not operate normally by following the operating instructions. Adjust only those controls that are covered by the operating instructions as improper adjustment of other controls may result in damage and will often require extensive work by a qualified technician to restore the LCD TV to normal operation.
- e. If the LCD TV has been dropped or the cabinet has been damaged.
- f. When the LCD TV exhibits a distinct change in performance-this indicates a need for service.

When replacement parts are required, be sure the service technician has used replacement parts specified by the manufacturer that have the same characteristics as the original part. Unauthorized substitutions may result in fire, electric shock, or injury to persons.

Upon completion of any service or repairs to this LCD TV, ask the service technician to perform routine safety checks to determine that the LCD TV is in safe operating condition.

TABLE

SAFETY INSTRUCTIONS	3	SETUP	27
FEATURE AND DESIGN	5	TIMER	
PREPARATION	6	FUNCTION	
PARTNAMES AND FUNCTIONS	6	MENU OPERATION (PC/HDMI mode)....	35
PREPARATION	7	PICTURE	35
CONNECTING LCD TV	8	AUDIO	35
CONNECTING THE AC POWER CORD	8	SETUP	36
CONNECTING OUTDOOR AERIAL	8	TIMER	36
CONNECTING A COMPUTER	9	FUNCTION	36
CONNECTING VIDEO EQUIPMENT	10	APPENDIX	37
BEFORE OPERATION	11	CLEANING LCD TV	37
OPERATION OF REMOTE CONTROL	11	FUNCTION OF PRODUCT SAFETY	
TURNING ON/OFF LCD TV	15	FEATURE	37
SELECTING INPUT SOURCE	15	TROUBLESHOOTING	38
CHANNEL SELECTION	15	specifications	39
SELECTING CHANNEL SOURCE	16		
SOUND SYSTEM	16		
COLOUR SYSTEM	16		
DISPLAY	16		
VOLUME CONTROL	17		
ECO	17		
VIRTUAL SURROUND	17		
STILL	17		
STEREO/MONO	17		
ASPECT RATIO	18		
TIMMER SETTING	19		
SPORTS	19		
TEXT / TV	19		
TEXT CANCEL	20		
TEXT INDEX	20		
TEXT SUBCODE	20		
TEXT SIZE	20		
TEXT HOLD	20		
TEXT RED	20		
TEXT GREEN	20		
TEXT YELLOW	20		
TEXT BLUE	20		
MENU OPERATION (TV/AV mode)	21		
TUNING THE TV FOR THE FIRST TIME	21		
PICTURE	22		
AUDIO	25		

FEATURE AND DESIGN

◆ Picture

- **LCD Panel**
1920 x 1080 pixel Full HD LCD Panel makes perfect reproduction of 1080p/1080i HD contents in pixel-to-pixel. (for 42" HD panel)
1366 x 768 pixel LCD Panel makes perfect reproduction of 1080p/1080i HD contents in pixel-transfer to -pixel.
- **Video Enhance Engine**
Video Enhance Engine. SANYO High Quality image Processing Technology processing clear, dynamic, natural and realistic Picture along with HD/SD LCD Panel Technology.
- **Dynamic AC**
The AC (Automatic image Control) circuit compensates picture contrast and brightness level dynamically and reproduces bright and high-contrast picture. (see page 22,23)

◆ Sound

- **NICAM/A2 Stereo**
It's the Stereo Sound PAL Color TV Broadcasting System upgrading Mono-sound TV service to stereo or dual-language sound.(see page 25)
- **Bass Boost**
Bass Boost providing powerful sound makes viewing experience bass Boost sound. (see page 24)
- **Virtual Surround**
Virtual Surround providing powerful sound makes viewing experience Virtual Surround.

◆ Feature

- **Super Mode**
Just by pressing the button, sport mode optimizes picture and audio settings suitable for each sport program. (see page 19)
 - **Colorful World**
Dynamic picture and sound performance setting (Default setting).
 - **Green Field**
Suitable setting for Football, Golf program etc.
 - **Snow World**
Suitable setting for Skiing, Ice Skating program etc.
 - **Water World**
Suitable setting for Swimming, Diving program etc.
 - **Indoor Sport**
Suitable setting for Basketball, Boxing program etc.

◆ Feature

- **Auto ECO**
Automatically adjust by ECO 1/ECO 2/ECO 3.
- **Light Sensor formation**
Ambient light sensor automatically adjusts picture brightness to provide more relaxing view for your eyes. (see page 16)

◆ Compatibility

- **Full Multy System**
PAL, SECAM, NTSC, NTSC 4.43 system can be connected. (see page 16)
- **HD-Ready**
1080p, 1080i, 720, High Definition signals are receivable.
- **HDMI**
HDMI provides complete transmission of digital image and sound signals without any quality deterioration. DVI can be connected to HDMI.
- **PC Input**
Personal Computer/Laptop can be connected with automatic resolution adjustment.
- **Terminals**
HDMI for BluRay Player etc.
D -SUB 15-pin for PC input etc.
Component Video for DVD
S-Video/Video for VCR /DVD

◆ Others

- **Wall Mounting**
It's designed for VESA Standard wall hanging bracket.
- **Light Commercial Mode**
By entering Dealer mode, Volume Lock, Sert Mode, OSD, RC, Reset, AC Power Mode can be selected. Convenient for placing in Hotel, Hospital, School, Store, Bank etc.

PREPARATION

PARTNAMES AND FUNCTIONS

FRONT

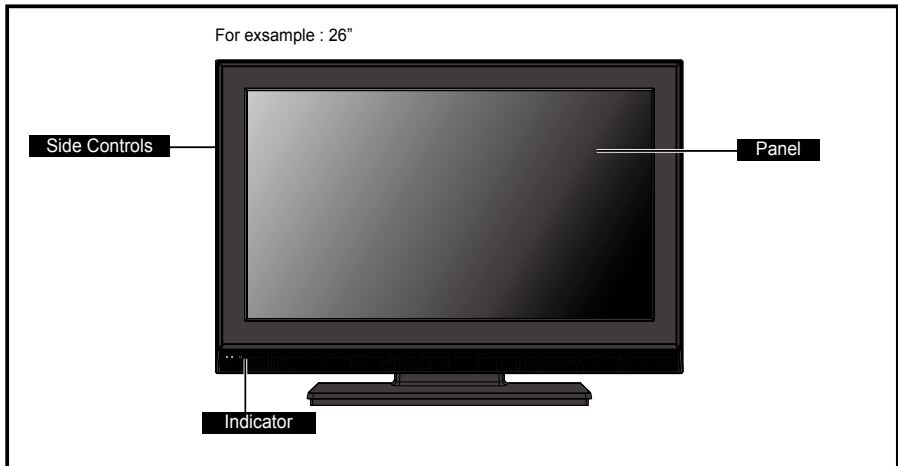

For example : 26"

INDICATORS

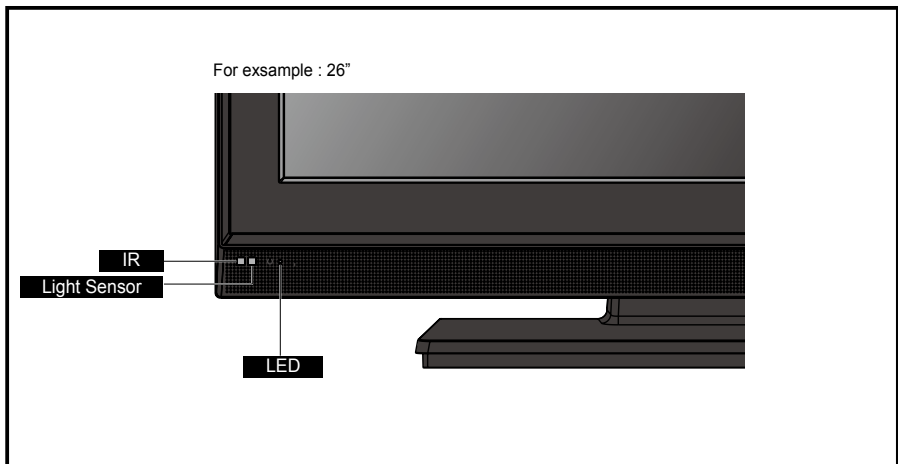

CARE FOR USING LCD TV

- Do not bump or scratch the panel surface as this causes flaws on the surface of the screen.
- There may be some tiny black points and/or blight points on the **SCREEN**. These points are normal.

SIDE CONTROLS (Each button on the control panel has the same function with its counterpart on the remote control.)

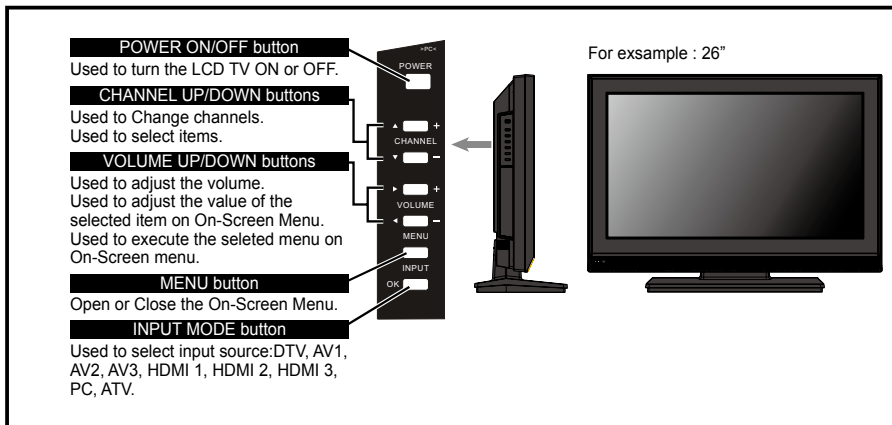

BACK TERMINALS

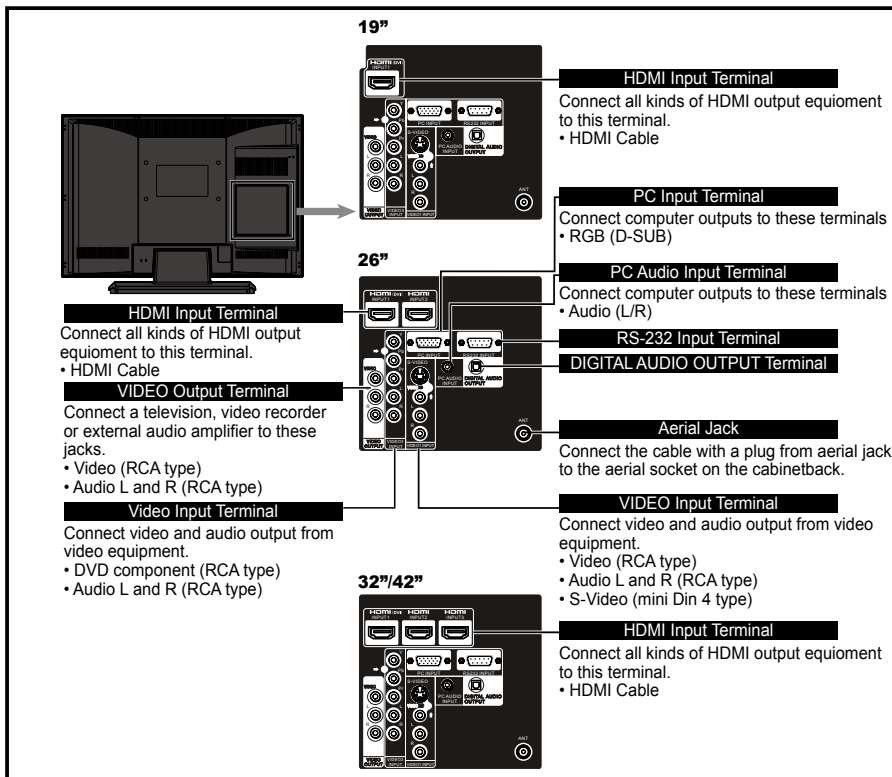

CONNECTING LCD TV

CONNECTING THE AC POWER CORD

This LCD TV uses nominal input voltages of 100-240V AC. This LCD TV automatically selects the correct input voltage. It is designed to work with single-phase power systems. To reduce risk of electrical shock, do not plug into any other type of power system. Consult your authorized dealer or service station if you are not sure of the type of power being supplied. Connect the LCD TV with all peripheral equipment before turning the LCD TV on.



CAUTION

For safety, unplug AC power cord when the LCD TV is not in use.

For example : 26"

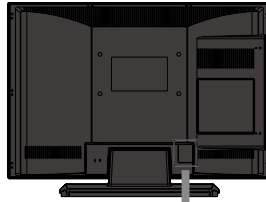

AC POWER CORD

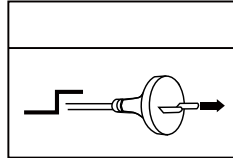

To the AC Outlet (100-240V AC) Pulls the AC power cord out from the LCD TV. The AC outlet must be near this equipment and must be easily accessible.

CONNECTING OUTDOOR AERIAL

Cable used for connection (This Outdoor Aerial cable is not supplied with this LCD TV.)

- Aerial Cable

NOTE:

For all aerial circuit problems please consult your local dealer.

For example : 26"

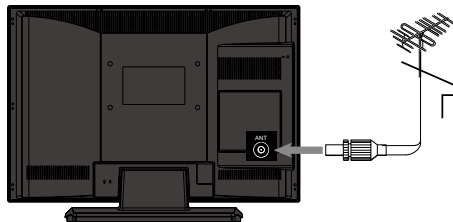

CONNECTING A COMPUTER

Cable used for connection (This cable is not supplied with this LCD TV.)

- PC/VGA Cable (D-SUB 15pin)
- HDMI Cable
- MAC Adapter (in the case of connecting Macintosh computer)
- Audio Cable [Mini Plug (L/R)]



NOTE:

When connecting the cable, AC Power Cords of both LCD TV and external equipment should be disconnected from AC outlet. Turn LCD TV and peripheral equipment on before your computer is switched on.

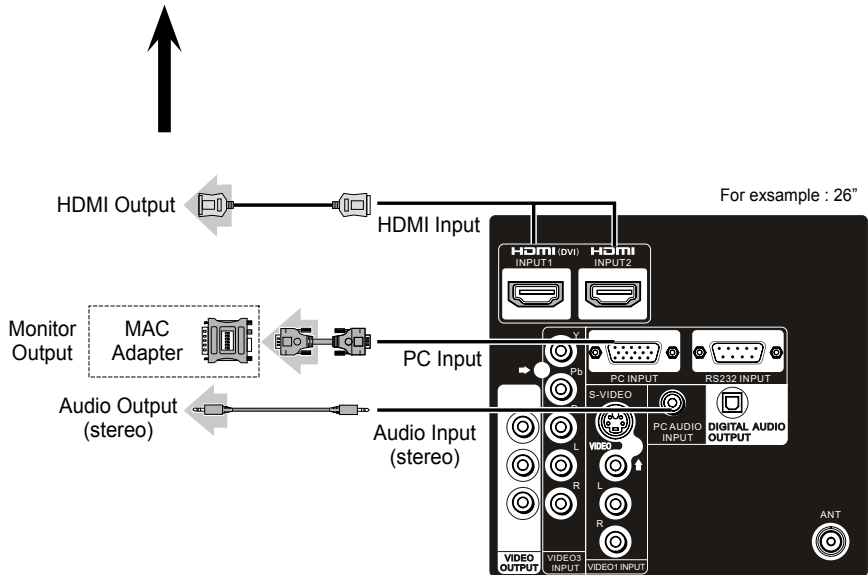
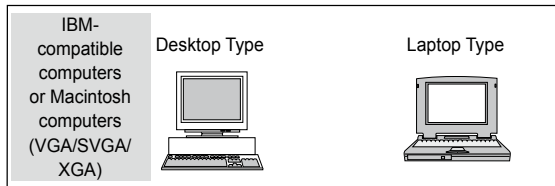

NOTE : You can connect the DVI source to HDMI input terminal by using the DVI to HDM I converter, and you just can watch image, but without sound.

CONNECTING LCD TV

CONNECTING VIDEO EQUIPMENT

Cables used for connection (These cables are not supplied with this LCD TV.)

- Video Cable (RCA X 1), S-Video Cable, Audio Cable (RCA X2) : Video 1 or Video 2
- Video Cable (RCA X3), Audio Cable (RCA X 2) : DVD (Component Video)
- Video Cable (RCA X 1), Audio Cable (RCA X2) : Monitor Outputs
- HDMI Cable: HDMI Input



NOTE : When connecting the cable, AC Power Cords of both LCD TV and external equipment should be disconnected from AC outlet.

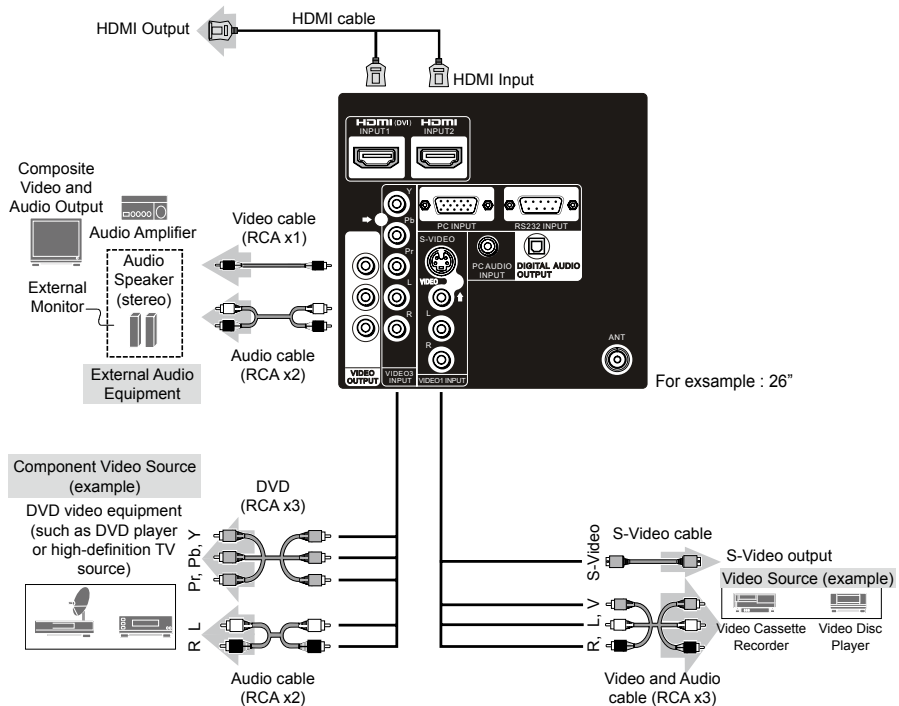

AV OUT

Note:
Video (RCA) output is for TV, AV or S-VIDEO only.

OPERATION OF REMOTE CONTROL

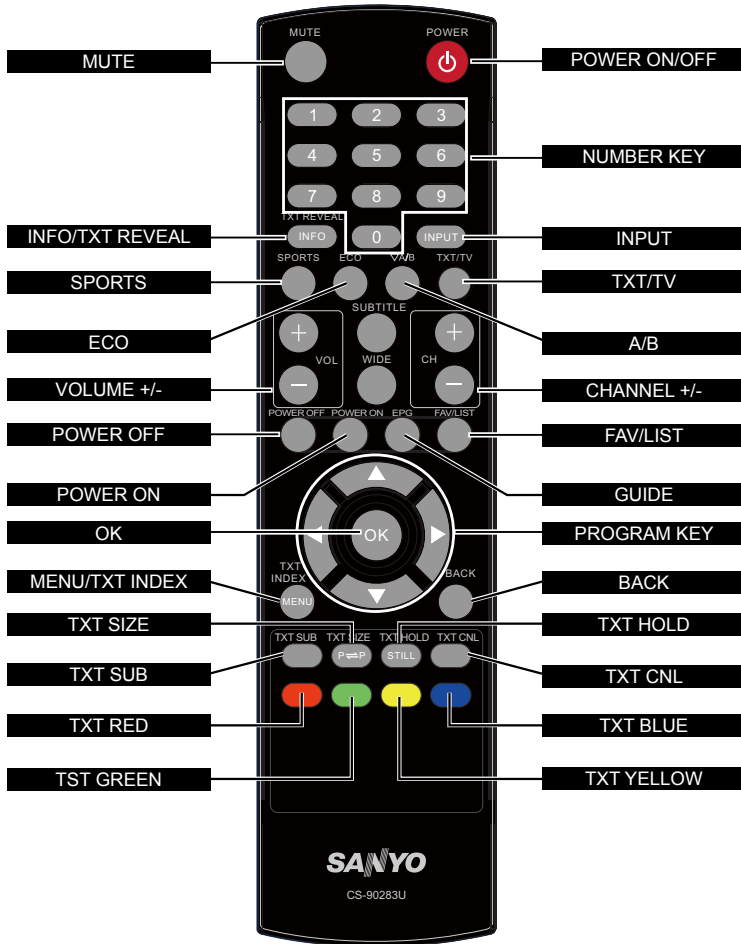

Note: In different mode, some buttons have different functions.

BEFORE OPERATION

OPERATION RANGE

Point Remote Control toward LCD TV (Infrared Remote Receiver) whenever pressing the buttons. Maximum operating range for Remote Control is about 16.4'(5m) in front, about 30° to the left or the right, about 15° for up or down.

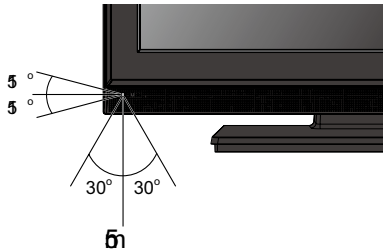

REMOTE CONTROL BATTERIES INSTALLATION

- 1 Remove the battery compartment cover .

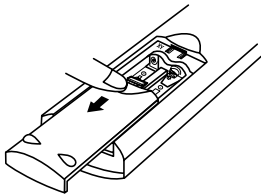

- 2 Insert two size AAA batteries (1.5V) according to "+" and "-" polarity markings inside the battery compartment.

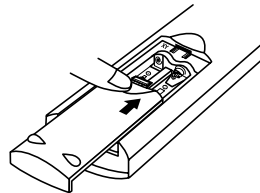

- 3 Close the battery compartment cover.

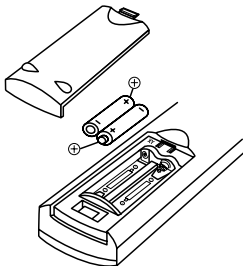

To insure safe operation, please observe the following precautions:

- Use (2) AAA, alkaline batteries.
- Replace two batteries at the same time.
- Do not use a new battery with a used battery.
- Avoid contacting with water or liquid.
- Do not expose the Remote Control or Batteries to moisture, or heat such as sunshine, fire or the like.
- Do not drop the Remote Control.
- If a battery has leaked on the Remote Control, carefully wipe case clean and install new batteries.
- Risk of explosion if battery is replaced by an incorrect type.
- Dispose of used batteries according to the instructions.

BEFORE OPERATION

ON-SCREEN MENU

TV/AV MODE MENU LIST

MAIN MENU (CHANNEL MENU)

Note : "SET UP" menu is only active in TV mode.

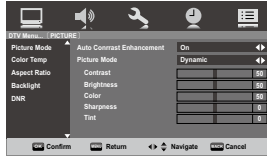

PICTURE MENU

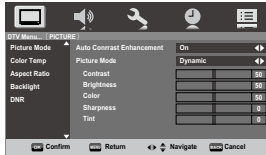

AUDIO MENU



SETUP MENU



TIMER MENU

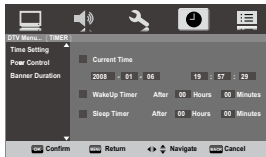

FUNCTION MENU



BEFORE OPERATION

ON-SCREEN MENU

PC/HDMI MODE MENU LIST

MAIN MENU (PICTURE MENU)

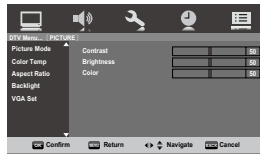

PICTURE MENU



AUDIO MENU



SETUP MENU



TIMER MENU

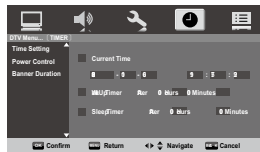

FUNCTION MENU



Note : 1. "PC ADJUST" is only active in PC mode.

2. SOUND/TIMER/OSD menu in PC/HDMI mode is the same as TV/AV mode, please refer to page 13~14.

BASIC OPERATION

TURNING ON/OFF LCD TV

- 1 Complete the peripheral connections before turning on LCD TV. (Please refer to "CONNECTING LCD TV".)
- 2 Connect LCD TV 's AC Power Cord into an AC outlet.
- 3 Press POWER ON/OFF button on Side Controls of LCD TV or on Remote Control to turn it ON. The POWER indicator will light up (green). Press POWER ON/OFF button again to shift it to stand-by status, the POWER indicator will become red.

NO SIGNAL SHUT OFF

This TV set incorporates the NO SIGNAL SHUT OFF function. If no signal is input in TV mode, "OFF 00:15" will display for about 15 minutes and TV will be turned off automatically.

SELECTING INPUT SOURCE

Select mode "DTV", "VIDEO 1", "VIDEO 2", "VIDEO 3", "HDMI 1", "HDMI 2", "HDMI 3", "PC", "ATV", by pressing INPUT button on Remote Control or on Side Controls.

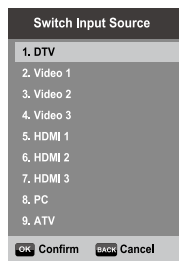

CHANNEL SELECTION

There are 256 channels can be selected on the LCD TV.

DIRECT SELECTION

For direct access to program using the (0-9) numeric button.

- 1) For selection of channel position 0-9. Example: For channel position 8, press the "8" button.
- 2) For selection of channel position 10 - 99. For channel position 25, press the DIGIT button to display "- -", then press "2" and "5" buttons.
- 3) For selection of channel position 100 - 199. For channel position 125, press the DIGIT button twice to display "1 ", then press "2" and "5" buttons.
- 4) For selection of channel position 200 - 255. For channel position 235, press the DIGIT button three times to display "2 ", then press "3" and "5" buttons.

CHANNEL UP/DOWN

Press POINT ▲/▼ buttons on Side Controls or on Remote Controls to select programs.

- Press POINT ▲ button to select next channel.
- Press POINT ▼ button to select previous channel.

BASIC OPERATION

SELECTING CHANNEL SOURCE

Press **P↔P** button to switch between the previous channel and the current channel.

For example, now you are watching channel "4", but you watched channel "2" previously. If you press **P↔P** button, channel "2" will appear immediately.

SOUND SYSTEM

Press **SOUND SYSTEM** button repeatedly to select "D/K", "I", "B/G" or "Auto" until the best sound effect is reached.

COLOUR SYSTEM

Press **COLOUR SYSTEM** button then you can see display.

DISPLAY

Press **DISPLAY** button on Remote Control to display the status of LCD TV. Press again to remove the display.

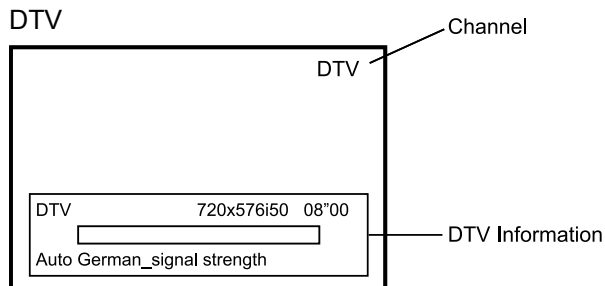
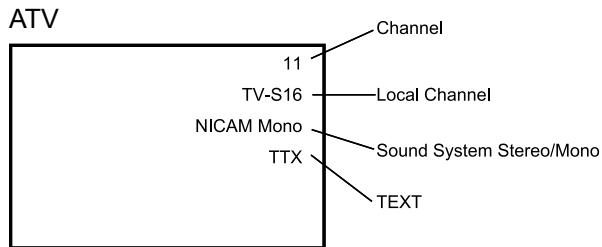

VOLUME CONTROL

To adjust the volume value desired by pressing POINT buttons on Remote Control or on Side Controls. The volume dialogue box will appear on the screen for a short while. POINT button to increase volume, and POINT button to decrease volume.

VOLUME  32

ECO

This function is used to automatically adjust panel's brightness by ambient brightness. Press ECO button on Remote Control to set "ECO 1", "ECO 2", "ECO 3" or "ECO OFF".

VIRTUAL SURROUND

Wonderful Virtual Surround has set in the TV, you can enjoy splendid Virtual Surround effect in your family. Press Menu button on Remote Control to set "Virtual Surround On" or "Virtual Surround OFF".

Select this mode for user to call out the preset sound adjustment in SOUND menu.

STILL

Press TXT HOLD button to switch the still function On or Off.

When in PIP mode, still function can still main picture.

To cancel "Still" function:

Press TXT HOLD button or PIP button to cancel the function, or you can switch the input source to cancel it also.

Note: When the still function is On, the picture will still, but the sound will remain.

The function doesn't work when the input signal is 1080p.

STEREO/MONO

Simply press STEREO/MONO button to select the following audio signals: "STEREO", "MONO", "NICAM", "A" and "B".

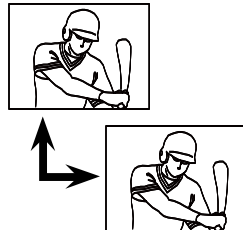

BASIC OPERATION

ASPECT RATIO

Select screen size among "Wide", "Super Live 2", "Cinema2", "4:3", "Super Live 1", "Cinema 1", "Subtitle", "14:9" and "Auto" by pressing **WIDE** button on Remote Controls.

*Only "Wide" and "4:3" mode can be selected when the input mode is "VGA", "HDMI" and the input signal is 1080i, 720p or 1080p.

WIDE

Use this setting when watching a widescreen DVD, widescreen video tape or a 16:9 broadcast (when available). Due to the range of widescreen formats (16:9, 14:9, 20:9 etc.) black bars may be visible on the top and bottom of the screen.

SUPER LIVE 2

If a 'side panel format' signal is being received this setting will enlarge the image to fit the screen by stretching the image horizontally and vertically, holding better proportions at the centre of the image. Some distortion may occur.

CINEMA 2

When watching 'all sides panel format' films/video tapes, this setting will eliminate or reduce the black bars at all sides of the screen by zooming in and selecting the image without distortion.

4:3

Use this setting to view a true 4:3 broadcast.

SUPER LIVE 1

This setting will enlarge a 4:3 image to fit the screen by stretching the image horizontally and vertically, holding better proportions at the centre of the image. Some distortion may occur.

CINEMA 1

When watching 'letterbox format' films/video tapes, this setting will eliminate or reduce the black bars at the top and bottom of the screen by zooming in and selecting the image without distortion.

SUBTITLE

When subtitles are included on a letterbox format broadcast, this setting will raise the picture to ensure that all the text is displayed.

14:9

Use this setting when watching a 14:9 broadcast.

Auto

WIDE button

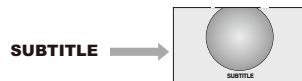
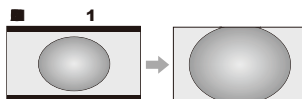
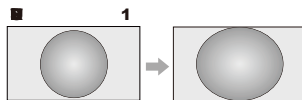
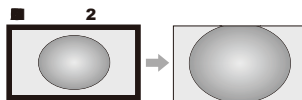
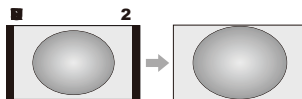
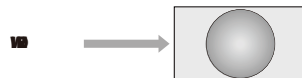
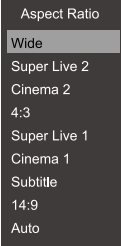

TIMMER SETTING

To set TIMER SETTING by pressing TIMER Menu on remote control. The timer dialogue box will appear on the screen for a short while.

To select "WakeUP Timer" or " Sleep Timer" with TIMER buttons.

SPORTS

Select sports mode "Field Game", "Winter Sport", "Marine Sport", and "Indoor Sport" by pressing SPORTS button repeatedly on Remote Controls.

Field Game

(Picture)

Emphasize vivid green of the grass. High contrast, deep black for the bright scene.

(Sound)

Emphasize surrounded cheers and sound of hitting the ball.

WINTER SPORT

(Picture)

Reduce white saturation of snow. Emphasize primary colors of the skiing suit by slightly reducing contrast and brightness and slightly increase the color gain.

(Sound)

Emphasize mid and high range of sound (sliding sound of skiing and skating)

MARINE SPORT

(Picture)

Emphasize blue sky and blue ocean with high contrast with deep black.

(Sound)

Emphasize the sound of waves.

INDOOR SPORT

(Picture)

Emphasize red and skin color and clarify the figures in the dark stadium.

(Sound)

Emphasize surrounded cheers and sound of bumping bodies. Clear voice of an announcer.

SPORT button

SPORT Mode

Off

Field Game

Winter Sports

Marine Sports

Indoor Sports

TEXT / TV

Press TXT/TV button to select teletext. Press again will display:

- TV mode : TV → TEXT mode → MIX mode → TV
- AV mode : AV → TEXT mode → MIX mode → AV

Note:

- TEXT mode: TEXT screen is displayed.
- MIX mode: TV /AV (broadcast image) screen and the contents of TEXT(it superimposed) are displayed simultaneously.
- CANCEL mode: TEXT/MIX MODE is canceled temporarily and broadcast image is displayed. However, the available keys are the same as TEXT mode.
- In the following state, the TXT/TV button is invalid.
 - RF non-signal (Auto shut off)
 - AV non-signal (Blue back)
- The TXT/TV button is pressed during the CANCEL mode. The CANCEL mode will be canceled, and it will become a TEXT screen.

BASIC OPERATION

TEXT CANCEL

- When press the TEXT CANCEL button in TEXT or MIX mode, the TV picture appears on the screen. CANCEL mode will be canceled if the button pressed once again.
- CANCEL mode is also canceled by the TXT/TV button.
- In CANCEL mode, "CAN " is always displayed on the screen upper left.

TEXT INDEX

Press the INDEX button to select the teletext index page in TEXT, MIX , CANCEL mode.

TEXT SUBCODE

1. Press TEXT SUB CODE button, "110/. . ."will be displayed (e.g. the current page is 10).
2. Press the NUMERIC buttons(0-9) to enter the sub page. For example, to select sub page 4, press NUMERIC buttons 0-0-0-4, and "110/0004" will be displayed.

TEXT SIZE

Press TEXT SIZE button to enlarge the top half of the text page.

Press TEXT SIZE button again to enlarge the bottom half of the text page. Press TEXT SIZE button again to return to the normal size page.

Normal → top half enlargement → bottom half enlargement → normal

Note:

- During the top half enlargement or the bottom half enlargement mode, if a page request is performed by [0] - [9] button and the TEXT INDEX button, it will become the normal mode and a page will be requested.
- If HOLD ON / OFF is performed during the top half enlargement mode, it will still at the top half enlargement mode. (AHOLD symbol display)
- If HOLD ON / OFF is performed during the bottom half enlargement mode, it will still at the bottom half enlargement mode. (AHOLD symbol not display)

TEXT HOLD

Press TEXT HOLD button to stop page request and updating.

- HOLD ON: The symbol  will appear instead of the page number.
- Update of TELETEXT is forbidden. It stops on the TEXT screen display now. HOLD OFF: A status display will be page number display.
- TELETEXT page data is updated.
 - A screen is updated by reception of the UPDATE signal.
 - A screen is eliminated by reception of an ERASE signal.
 - TEXT HOLD button does not work except a text function.

TEXT RED

The page of a red prompt is required. (also cancel mode)

TEXT GREEN

The page of a green prompt is required. (also cancel mode)

This button does's work except for TEXT mode .

TEXT YELLOW

The page of a yellow prompt is required. (also cancel mode)

This button does's work except for TEXT mode .

TEXT BLUE

The page of a blue prompt is required. (also cancel mode)

MENU OPERATION (TV/AV mode)

TUNING THE TV FOR THE FIRST TIME

Before switching on the TV, put your decoder and media recorder to Standby if they are connected and ensure the antenna is connected. To setup the TV use the buttons on the remote control as detailed on page.

- 1 This screen will appear the first time that the TV is switched on and each time the TV is reset.
- 2 Press ◀▶ buttons to select the "Menu language" function. Language include the "English", "Français" and "中文".
- 3 Use ▼ button to select "Province/State". Press ◀▶ buttons to select the state in which you live. State include the NSW/ACT(New South Wales/Australian Capital Territory). VIC(Victoria), QLD(Queensland), SA(South Australia), WA(Western Australia), TAS(Tasmania) and NT(Northern Territory).
- 4 Press Ⓞ to setup "Energy Saving Mode".
- 5 Press ◀▶ buttons to select the "Energy Saving Mode".

Notes:

- To ensure your television is operating at optimal energy efficiency, select ECO mode during initial activation. ECO mode is recommended for normal home use.
 - **Energy Saving Mode:** The factory default settings of this television meet ENERGY SAVING requirements. Changing Picture Settings may increase energy consumption, possibly beyond the limits required for ENERGY SAVING qualification.
 - To return to ECO mode settings, select Standard picture mode.
 - **Standard** picture mode is used to achieve published average power values, and this mode is recommended for normal home use.
- 6 Press Ⓞ to set "Energy Saving Mode" and to start ATV/DTV Scan.

The Auto Scan screen will appear and the TV will automatically start to search for available stations. The progress bar will move along the line.

- 7 When DTV search is completed, the TV will automatically turn to the lowest logical channel number.

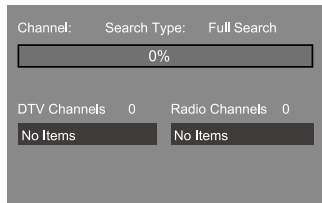
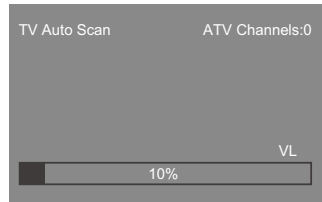
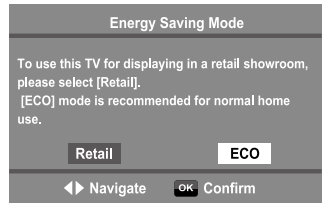
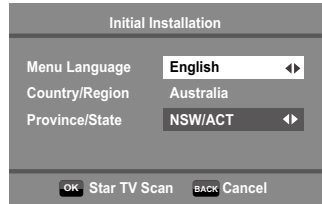

MENU OPERATION (TV/AV mode)

PICTURE

- 1 Press **MENU** button and the main menu will appear. Press ◀▶ buttons to select "PICTURE".
 - 2 Press ▲▼ buttons to select the item desired.
 - 3 Press ◀▶ buttons to adjust value.
- Press **BACK** button to return to the previous menu.

PICTURE MODE

- Select "Dynamic", "Standare", "Movie" pressing ◀▶ buttons.

Mode	Picture quality
Dynamic	Bright and dynamic picture
Standard	Standard picture
Movie	Mild soft picture
Memory	Memory the picture quality you set

Note:

- In the PC input mode this mode is not available.

Adjusting the Basic picture quality

- 1 Press MENU button, then press ◀▶ buttons to display the "PICTURE".
- 2 Press **OK** button, then press ▲▼ buttons to select "Picture Mode".
- 3 Press ◀▶ buttons to select "Memory".
- 4 Press ▲▼ buttons to select an item you want to adjust, then press ▲▼ buttons to adjust the setting as required.

Selection	◀	Pressing	▶
Contrast	lower		higher
Brightness	darker		lighter
Color	paler		deeper
Sharpness	softer		sharper
Tint	reddish		greenish

Note:

- The Tint may only be adjust on a tape which has been recorded and played back on an NTSC VCR.
- In the PC input mode (page xx) Sharpness mode is not available.

Color Temperature

You can change the tone of the picture by selecting from three preset color temperatures: "Cool", "Normal" or "Warm".

- 1 From the "Picture", press ▲▼ buttons to select "Color Temp" then press **OK**.
- 2 Press ◀▶ buttons to select mode you prefer.

Cool: Lends a blue hue to the picture.

Normal: Neutral

Warm: Lends a red hue to the picture.

SCREEN MENU

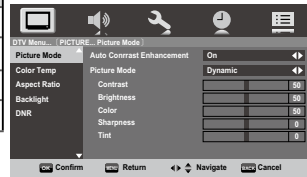
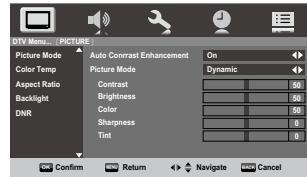

MENU OPERATION (TV/AV mode)

Aspect Ratio

Select screen size among "Wide", "Super Live 2", "Cinema2", "4:3", "Super Live1", "Cinema 1", "Subtitle", "14:9" and "Auto" on Menu. (See Page 18)

- 1 From the "PICTURE", press ▲▼ buttons to select "Aspect Ratio" then press **OK**.
- 2 Press ◀▶ buttons to select screen size.

Backlight

In order to improve screen visibility, the active backlight control sets the screen brightness automatically during dark scenes.

- 1 From the "PICTURE", press ▲▼ buttons to select "Backlight" then press **OK**.
- 2 Press ◀▶ buttons to select "Off" or "On".
- 3 If you want to adjust Backlight manually, turn Active Backlight Control to Off, then press ▼.
- 4 Press ◀▶ buttons to adjust the settings as required.

DNR

If the receiving signal is weak and the picture is blurry, the picture may be improved when using this function.

- 1 From the "PICTURE", press ▲▼ buttons to select "DNR" then press **OK**.
- 2 Press ▲▼ buttons to select an item you want to adjust, press ◀▶ buttons to adjust the settings as required.

Note:

- In the PC input mode this mode is not available.

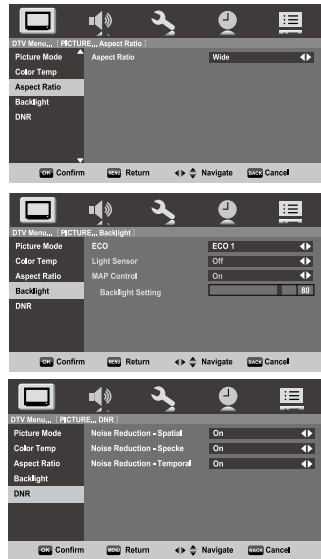

MENU OPERATION (TV/AV mode)

Cinema Mode (VIDEO 1/VIDEO 2 only)

A movie film's picture runs at 24 frames a second, whereas movie software such as DVD, etc., that you enjoy watching on television at home runs at 30 (NTSC) or 25 (PAL) frames a second. To convert this signal to reproduce a smooth motion and picture quality, select the "On" mode.

Effective signal and setup conditions:

- When the Video input mode is selected.
 - When the input signal format is 480i and 576i signals,
- 1 Press MENU button, then press ◀▶ buttons to display the "PICTURE" menu then press Ⓚ .
 - 2 Press ▲▼ buttons to select "Cinema Mode", and will display "PICTURE" menu. Press ▲▼ buttons to select then press Ⓚ .
 - 3 Press ◀▶ buttons to turn "On" or "Off".

Note:

- When a DVD movie with subtitle is playing back, this mode may not work correctly.
- Cinema Mode only support to VIDEO 1, VIDEO 2, when AV connection setting is in CVBS mode.

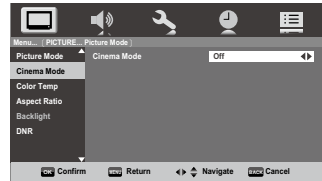

MENU OPERATION (TV/AV mode)

AUDIO

- 1 Press **MENU** button and the main menu will appear. Press ◀▶ buttons to select "AUDIO", and will display AUDIO menu.
- 2 Press ▲▼ buttons to select the item desired.
- 3 Press ◀▶ buttons to adjust value.
 - Press **BACK** button to return to the previous menu.

Selectable Sound (Digital only)

- 1 Press MENU button, then press ◀▶ buttons to display "AUDIO", then press **OK**.
- 2 Press ▲▼ buttons to select the Selectable Sound, then press **OK** and ◀▶ to select "Standard", "Movie", "Music" and "User".
- 3 In User item, you can press ▲▼ buttons to select an item you want to adjust, press ◀▶ to adjust the settings as requires.
- 4 When you select "Standard", "Movie", "Music", the setting was fixed and can't adjust.

Selection	◀ Pressing	▶
Bass	weaker	stronger
Treble	weaker	stronger
Blance	decreases the right channel	decreases the left channel

Bass Boost (For User mode adjust)

- 1 From the "AUDIO", press ▲▼ to select "Bass Boost" then press **OK**.
- 2 Press ◀▶ to select "Off", "Low", "Mid" and "High".

Note:

- The Bass Boost effect is active only when the sound outputs from the speaker.

Virtual Surround (For User mode adjust)

The Virtual Surround is especially useful if you want to setting up virtual surround for TV.

- 1 From the "Sound", press ▲▼ to select "Virtual Surround" then press **OK**.
- 2 Press ◀▶ to select "Off" or "On".

Note:

- The Virtual Surround effect is active only when the sound outputs from the speaker.
- When the Selectable Sound setting isn't in User mode, the "Virtual Surround" menu is not selectable.

SCREEN MENU

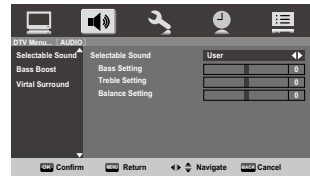

MENU OPERATION (TV/AV mode)

MTS (analog TV only)

Auto mode

The MTS Auto mode automatically recognize stereo/bilingual programs depending on the broadcast signal.

- 1 Press **MENU** button, then press ◀▶ buttons to display the "SOUND" menu then press **OK** .
- 2 Press ▲▼ buttons to select "MTS" then press **OK** and ◀▶ buttons to "Auto" or "Mono".
- 3 Press ◀▶ buttons to turn "On" or "Off".

Mono mode

If you experience noise or poor reception of any stereo/bilingual program, set the Sound mode to Mono. Noise will be reduced and reception may improve.

Note:

- If you experience noise with a particular program on whose channel reception is usually good, try setting MTS mode to Auto, then switch ^{VAG} to Mono (monaural).

Dual 1 or Dual 2 mode (analog TV only)

You can hear only Dual 1 or Dual 2 sound selected, whenever bilingual programs are received.

- 1 Press **MENU** button, then press ◀▶ buttons to display the "SOUND" menu then press **OK** .
- 2 Press ▲▼ buttons to select "Dual" then press **OK** and ◀▶ buttons to "Dual 1" or "Dual 2".
- 3 Press ◀▶ buttons to turn "On" or "Off".

Mono mode

If you experience noise or poor reception of any stereo/bilingual program, set the **Sound** mode to Mono. Noise will be reduced and reception may improve.

Note:

- When the MTS setting is in **Mono** mode, the "Dual" is not selectable.
- The "Dual" setting status remains even if the TV is turned off.

SCREEN MENU

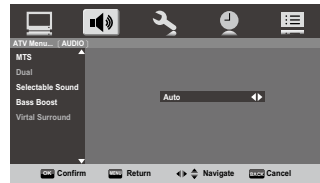

MENU OPERATION (TV/AV mode)

SETUP

- 1 Press **MENU** button and the main menu will appear. Press ◀▶ buttons to select "SETUP", and will display "SETUP" menu.
 - 2 Press ▲▼ buttons to select the item desired.
 - 3 Press ◀▶ buttons to adjust value.
- Press **BACK** button to return to the previous menu.

Language

Country/Region

Full Search (Digital TV only)

As new services are broadcast, it will be necessary to re-tune the TV in order to view them.

Full Search will completely re-tune the TV and can be used to update the channel list. It is recommended that Full Search is run periodically to ensure that all new services are added. All stored programs and settings, including Timer entries, favorites and locked programs, will be lost.

- 1 Press **MENU** button, and ◀▶ buttons to display the "SETUP" menu.
- 2 Press ⓧ, and ▲▼ buttons to select "Full Search".
- 3 Press ⓧ, a confirmation screen will appear indicating that **This will do full search, Are you sure?**
- 4 Press ⓧ, to start "Auto tuning".

The below sample display shows "Full Search" in progress.

The channel number will show 1~69.

DTV Channels will display searched channel and name information.

Radio Channels will display searched channel and name information.

- 5 "Full Search" will show scan of "DTV Channels/Radio Channels" list.
- 6 When the search is complete, the TV will automatically tune to the lowest logical channel number.

Note:

- After the Full Search, the TV may have scanned identical channels being broadcast from different transmitters. Pressing ⓧ helps you to check Full Search result. If you do find channels with the same logical channel numbers but different physical channel numbers, it is recommended that you skip these duplicate channels and keep only one channel with the best signal strength as indicated by the signal strength bar in the on-screen information.

SCREEN MENU



MENU OPERATION (TV/AV mode)

MENU OPERATION (TV/AV mode)

MENU OPERATION (TV/AV mode)

MENU OPERATION (TV/AV mode)

Manual Search (Digital TV only)

If there were any missing channel after “Full Search”, these channels might be found by using “Manual Search” described in this section.

- 1 From the “SETUP”, press ▲▼ buttons to select “Manual Search”.
- 2 Press **OK**, then ◀▶ buttons to select then channel (0~69) you wish to search.
- 3 If scanning was successful, “Signal Strength” will appear at almost 100%. Repeat to scan other channels as necessary.
- 4 If scanning was unsuccessful, “Signal Strength” will appear at almost 0%.

At this point you can rescan the signal or refer to aligning the direction of the antenna to get the signal. Refer to your antenna installer if problem persists.

Note:

- **Signal Strength** refers to the input Radio Frequency (RF) signal strength as perceived by the RV. Note that too strong signal may cause erroneous readings. If you use an antenna booster and find that you still get a low signal level, your booster gain may be set too high. In this case, adjust the gain accordingly. You may also see the No Signal on the screen when the signal level is low.

Channel List (Digital TVonly)

- 1 From the “SETUP”, press ▲▼ buttons to select “Channel List”.
- 2 Press **OK** to display the “Channel List”.
- 3 Press ▲▼ button to select the program position you want to arrange.
- 4 Press ▶ button to display the breakdown menu.
- 5 Press ▲▼ button to select an item, then press **OK** to select the item as shown below:

- **Add to Fav:1** - Add selected channel to Favorite group 1.
- **Add to Fav:2** - Add selected channel to Favorite group 2.
- **Add to Fav:3** - Add selected channel to Favorite group 3.
- **Sort: LCN** - Sort all channels by channel number.
- **Sort: Name Down** - Sort all channels by name.
- **Sort: Name Up** - Sort all channels by name.
- **Delete** - Delete selected channel from the channel list.
- **Lock/Unlock** - Lock / Unlock selected channel by password.
- **Move Up** - Selected channel will be move up one channel.
- **Move Down** - Selected channel will be move down one channel.

Sorting program position

- The TV is capable of receiving a number of different channels depending upon where you live.
- Program sorting is an easy way of storing each channel on the program position of your choice.

Ex: To swap channel A1. TEN Digital 1 (Prog.13) for channel TEN Digital 2 (Prog.14).

SCREEN MENU

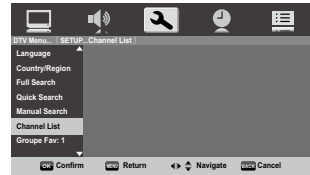
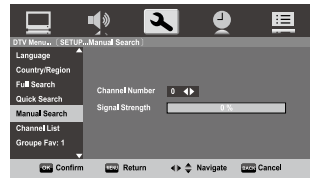

MENU OPERATION (TV/AV mode)

Favorite Channel

- 1 Press **MENU** button and ◀▶ button to select the "SETUP".
- 2 Press **OK** and press ▲▼ button to select "Groupe Fav. 1, 2 or 3" then press **OK**.
- 3 Press ▶ button will display the breakdown menu.
- 4 Press ▲▼ button to select an item.
 - **Add** - Add selected channel from the channel list.
 - **Delete** - Delete selected channel from the channel list.
 - **Move Up** - Selected channel will move up one channel.
 - **Move Down** - Selected channel will move down one channel.
- 5 You can press **OK** to save edited channel program and press **BACK** button to exit.
- 6 When viewing in Digital TV, press **OK** button to display the "Groupe Fav." channel list.
- 7 Press ▲▼ button to select your favorite program, then press **OK**

SCREEN MENU



Auto Tuning (Analog TV only)

First, use the "Auto Tuning" function to preset all the active channels in your area automatically. Then, arrange the preset channels with the "Manual Adjust" function so that you can tune into desired channels.

- 1 Press **MENU** button and ◀▶ button to select the "SETUP".
- 2 Press **OK** and press ▲▼ button to select "Auto Tuning".
- 3 Press **OK** a confirmation screen will appear indicating that **This will do auto tuning, Are you sure?**
- 4 Press **OK** to start the automatic search. The search will begin for all available stations.

This slide bar will move along line as the search progresses.

If you make a mistake, simply repeat steps 1-3 to start again from the beginning.

- 5 When the automatic search is completed, the TV will automatically return to the first program position.
- 6 Press **CH +** or **CH -** to start the automatic search. The search will begin for all available stations.

Note:

- When you preset the program channel which sound of broadcast transmission system adopts "M" system, the sound system may not be tuned correctly if the radio waves transmit badly. At that time, preset the channel by "Manual Search".

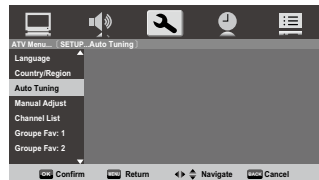

MENU OPERATION (TV/AV mode)

Manual Adjust (Analog TV only)

Use the "Manual Adjust" operation if desired channels cannot be preset with the Auto tuning or if you would like to preset channels to specific position numbers one by one.

- 1 From the "SETUP", press ▲▼button to select "Manual Adjust".
- 2 Press Ⓚ and to display the "Manual Adjust", then press ▲▼button to select the item as shown below.

- **Channel** - You can select channel no for which "Manual Adjust" is required.
- **Fine Tune Mode** - Press ◀▶ button to select "Auto fine Tune" and "Manual fine Tune".
- **Sound System** - Press ◀▶ button to select "Auto", "B/G", "I" or "D/K" system.
- **Label**- The video label allows you to label each input source for your TV.

To change or create video label:

- 1) Press ▲▼button to select "Label", and press yellow key to use the "EDIT" window as shown below.
- 2) Press ▲▼or◀▶ button to select character.
And you can use Delete and Caps Lock to edit your label name.
- 3) Press Save to store your settings.

Channel List (Analog TV only)

- 1 From the "SETUP", press ▲▼button to select "Channel List".
- 2 Press Ⓚ and to display the "Channle List".
- 3 Press ▲▼button to select the program position you want to arrange.
- 4 Press ▶button to display the reakdown menu.
- 5 Press ▲▼button to select an item, then press Ⓚ to select the item as shown below.

- **Skip** - If you turn this option on, selected channel will be skipped when you select channels with **CH+** or **CH-** button.
- **Lock/Unlock** - Lock / Unlock selected channel by password.
- **Delete** - Delete selected channel from the channel list.
- **Sort: Name Up** - Delete selected channel from the channel list.
- **Sort: Name Up** - Sort all channels by name.
- **Move Up** - Selected channel will be move up one channel.
- **Move Down** - Selected channel will be move down one channel.

SCREEN MENU

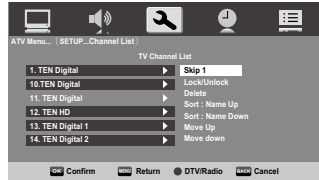
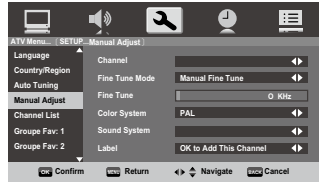

MENU OPERATION (TV/AV mode)

Displaying the on-screen information

Digital TV

When viewing in Digital TV, the on-screen information will give the details of the channel program currently being viewed.

The contains the following information:

- Current Channel Number and Name
- Received program video format.
- Current time
- Subtitle (closed-caption) availability (indicated by CC)
- Dolby® Digital audio track availability (indicated by **Dolby D**)
- Now and Next Program Names
- Parental Guidance code (PG, MA, G, R, etc.)
- Audio setting
- Signal Strength.

MENU OPERATION (PC/HDMI mode)

PICTURE

- 1 Press **MENU** button and the main menu will appear. Press ◀▶ buttons to select "PICTURE".
- 2 Press ▲▼ buttons to select the item desired.
- 3 Press ◀▶ buttons to adjust value.
 - Press **BACK** button to return to the previous menu.

PICTURE MODE

- Select "Contrast", "Brightness", "Color" pressing ◀▶ buttons.

Selection	◀ Pressing	▶
Contrast	lower	higher
Brightness	darker	lighter
Color	paler	deeper

VGA Set (PC only)

Adjustment to the position of the picture may be made to suit your viewing preferences.

- 1 Press **MENU** button and the main menu will appear. Press ◀▶ buttons to select "PICTURE", then press ⓧ .
- 2 Press ▲▼ buttons to select the "VGA Set", then press ⓧ .
- 3 Press ▲▼ buttons to select "H pos", "V pos", "Clock" and "Phase".
- 4 Press ◀▶ buttons to adjust to settings as required.

Automatically Adjusting the picture position (PC only)

Adjustment to the position of the picture may be made to suit your viewing preferences.

- 1 From the "VGA Set", press ▲▼ buttons to select "Auto Adjust"
- 2 Press ▶ button, then TV starts adjusting the picture position.

Note:

- For the details, please refer to "PICTURE" on page xx.

SCREEN MENU

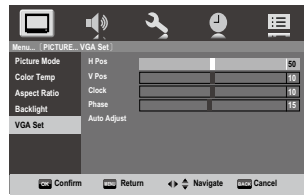
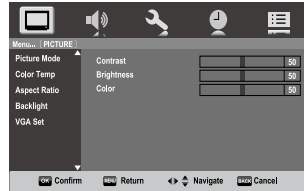

AUDIO

- 1 Press **MENU** button and the main menu will appear. Press ◀▶ buttons to select "AUDIO", and will display AUDIO menu.
- 2 Press ▲▼ buttons to select the item desired.
- 3 Press ◀▶ buttons to adjust value.
 - Press **BACK** button to return to the previous menu.

Note:

- For the details, please refer to "PICTURE" on page xx.

SCREEN MENU

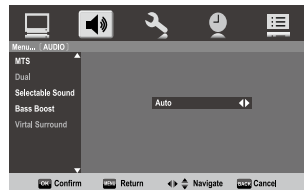

MENU OPERATION (PC/HDMI mode)

SETUP

- 1 Press **MENU** button and the main menu will appear. Press ◀▶ buttons to select "SETUP", and will display "SETUP" menu.
- 2 Press ▲▼ buttons to select the item desired.
- 3 Press ◀▶ buttons to adjust value.
 - Press **BACK** button to return to the previous menu.

Note:

- For the details, please refer to "AUDIO" on page xx.

SCREEN MENU

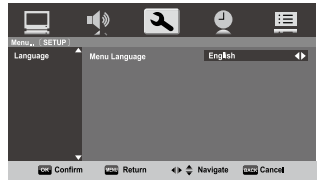

TIMER

- 1 Press **MENU** button and the main menu will appear. Press ◀▶ buttons to select "TIMER", and will display "TIMER" menu.
- 2 Press ▲▼ buttons to select the item desired.
- 3 Press ◀▶ buttons to adjust value.
 - Press **BACK** button to return to the previous menu.

Note:

- For the details, please refer to "TIMER" on page xx.

SCREEN MENU

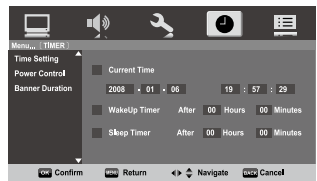

FUNCTION

- 1 Press **MENU** button and the main menu will appear. Press ◀▶ buttons to select "FUNCTION", and will display "FUNCTION" menu.
- 2 Press ▲▼ buttons to select the item desired.
- 3 Press ◀▶ buttons to adjust value.
 - Press **BACK** button to return to the previous menu.

Note:

- For the details, please refer to "FUNCTION" on page xx.

SCREEN MENU

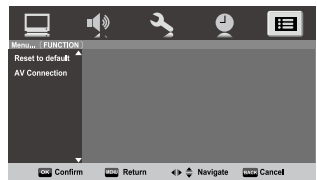

CLEANING LCD TV

Be sure to disconnect the AC Power cord from AC outlet before cleaning the LCD TV.

Clean your LCD TV as follows:

- Gently wipe the screen and cabinet with dry soft cloth.
- The screen is likely to be damaged if it is not maintained properly. Do not use hard objects like a hard cloth or paper. Do not use solvents or abrasions.

CAUTION :

Do not use benzene, thinner, or any volatile substances to clean the LCD TV. These chemicals may damage the cabinet finish.

FUNCTION OF PRODUCT SAFETY FEATURE

For protecting product safety, protection feature provided inside LCD TV. Refer to the following please.

TROUBLESHOOTING

Before calling your dealer or service center for assistance, check the matters below once again.

1. Make sure you have connected LCD TV to your equipment as described in the section "CONNECTING LCD TV".
2. Check cable connection. Verify that all external equipment and power cords are properly connected.
3. Verify that all power is switched on.
4. If LCD TV still does not produce an image, re-start the external equipment.
5. If the image still does not appear, unplug LCD TV from the external equipment and check the external equipment. The problem may be with your graphics controller rather than with LCD TV. (When you reconnect LCD TV, remember to turn the external equipment and TV off before you power up LCD TV. Power the equipment back on in order of : LCD TV and external equipment.)
6. If the problem still exists, check the following chart.

Problem	Try these Solutions
NO POWER	<ul style="list-style-type: none"> • Plug this LCD TV into the AC outlet. • Press ON /STAND -BY button on SIDE Control or on Remote Control to open this LCD TV. • Check POWER Indicator. If this indicator flashes, LCD TV has any trouble.
Remote Control does not work	<ul style="list-style-type: none"> • Check the batteries. • Make sure nothing is between the Remote Receiver and the Remote Control. • Make sure you are not too far from LCD TV when using Remote Control. • Maximum operating range is 16.4'(5m). • Is direct sunlight or strong artificial light shining on LCD TV 's Infrared Remote Receiver? Eliminate the light by closing curtains, pointing the light in a different direction, etc.
No image	<ul style="list-style-type: none"> • Check the connection between the external equipment and LCD TV. • When turning LCD TV on, it takes a few seconds to display the image. • Check the system that you select is corresponding with the external equipment or the video equipment. • Make sure the temperature is not out of the Operating Temperature (0°C ~ 40°C). • Turn off power, then turn on again, re-start LCD TV.
No sound	<ul style="list-style-type: none"> • Check Audio cable connection from Audio input source. • Adjust the Audio source. • Press VOLUME (+) button. • Press MUTE button.
There are tiny black points and/or bright point on the TV	<ul style="list-style-type: none"> • Dark or bright points of light (red, green, or blue) may appear on the screen. This is a characteristic of the LCD panels, not a malfunction of the LCD TV. • LCD panel is being produced with very high accuracy technology. There is 99.99% or more dot pixel, but there is also 0.01 % or less of dot pixel lack or dot pixel that is constantly lighted. This is not defect. • Regarding LCD panel characteristic, it may occur picture remain (look like a mirror) when the screen is changed if it displays same screen for a long time. Changing the picture or turn-off the power supply may recover. • Stripe pattern (more, interference stripes) may show up on the screen depend on the reflected picture.
Ab normal colour of image	<ul style="list-style-type: none"> • Adjust the value of colour. • Select different colour system.

WARNING :

High voltages are used to operate this LCD TV. Do not attempt to open the cabinet.

If the problem still persists after following all operating instructions, contact the sales dealer where you purchased LCD TV or the service center. Give the model number and explain the difficulty. We will advise you how to obtain service.

SPECIFICATIONS

Maximum Visible Range

19"	(H)409.8×(V)230.4 mm	18.51 inches
26"	(H)575.769×(V)323.712 mm	26 inches
32"	(H)697.685×(V)392.256 mm	31.51 inches
42"	(H)930.24×(V)523.26 mm	42.02 inches

Picture Resolution

19"	WXGA	1366 x 768
26"	WXGA	1366 x 768
32"	WXGA	1366 x 768
42"	Full HD	1920 x 1080

View able Angle(L/3)

19"	Horizontal & Vertical: 176°
26"	Horizontal & Vertical: 176°
32"	Horizontal & Vertical: 178°
42"	Horizontal & Vertical: 178°

Brightness

19"	250 cd/m ²
26"	450 cd/m ²
32"	450 cd/m ²
42"	500 cd/m ²

Contrast

19"	1000
26"	2500
32"	3000
42"	1400

Voltage

100-240VAC 50/60Hz ±10%

Colour System

PAL/NTSC/NTSC4.43/NTSC 3.58/SECAM D/K , I, M , B/G

Channel Coverage

Low band:	45.25 to 144.00MHz.
Mid band:	145.00 to 424.00MHz
High band:	425.00 to 866.25MHz

Speaker Size

19"	(L)74×(W)27×(H)19.5 mm
26"/32"/42"	(L)200×(W)40×(H)41.5 mm

Sound speciality

Maximum Output Power

19"	3W+3W
26"	7W+7W
32"	10W+10W
42"	10W+10W

Input terminals

							Video 1		Video 2		Video 3	
	PC	MINI STEREO JACK	HDMI/DVI	HDMI	RF	AV	SV	AV/SV Audio	AV	AV Audio	YPbPr	YPbPr Audio
19"	1	1	1	0	1	1	1	1	1	1	1	1
26"	1	1	1	1	1	1	1	1	1	1	1	1
32"	1	1	1	2	1	1	1	1	1	1	1	1
42"	1	1	1	2	1	1	1	1	1	1	1	1

Output terminals

	AV out	HeadPhone
19"	1	1
26"	1	1
32"	1	1
42"	1	1

Dimensions

(Including Stand)

19"	463.4(W) X 350.3(H) X 167.9(D)
26"	667.6(W) X 210.4(H) X 493.9(D)
32"	801.6(W) X 210.4(H) X 570.4(D)
42"	1022.8(W) X 697.4(H) X 250.2(D)

Net Weight

(Including Stand)

19"	3.8 Kg
26"	7.9 Kg
32"	11 Kg
42"	16.8 Kg

Operating Environment

Operating Temperature: Operating:5°C to 35°C

Operating Humidity: 0 % to 90 %

Storage Temperature: 0°C to 40°C

Storage Humidity: 0% to 90% (non-condensing)

- Specifications are subject to change without notice.
- The On-Screen Menu and figures in this manual may differ slightly from the product.

APPENDIX

CONFIGURATIONS OF VGA TERMINALS

VGA IN (D-SUB) TERMINAL

Terminal : D -SUB15 PIN

Connect video output terminal of LCD TV to this terminal with VGAC able (not supplied). When connecting Macintosh computer, the MAC Adapter (not supplied) is required.

Pin Configuration

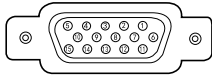

1	Red Input	9	No Connect
2	Green Input	10	Ground (Vertsync.)
3	Blue Input	11	Sense 0
4	Sense 2	12	Sense 1
5	Ground (Horiz.sync.)	13	Horiz. sync.
6	Ground (Red)	14	Vert. sync.
7	Ground (Green)	15	Reserved
8	Ground (Blue)		

(Table) Analog RGB Video Timing Chart

No	Signal mode			Horizontal Frequency(KHz)	Dot clock Frequency (MHz)
	Signal name	Resolution	Vertical Frequency(Hz)		
1	VGA	640x400	70.086	31.469	25.175
2	VESA	640x480	60	31.47	25.18
3	VESA	640x480	72	37.86	31.5
		640x480	75	37.5	31.5
		800x600	60	37.87	40
		800x600	72	48.07	50
		800x600	75	46.87	49.5
		1024x768	60	48.36	65
		1024x768	70	56.47	75
		1024x768	75	60.02	78.75
		1280x768	60	47.39	68.25
		1280x768	60	47.77	79.5
4	VESA	1280x768	75	60.28	102.25
		1280x1024	60	63.98	108
		1280x1024	75	79.97	135
5	VESA	1360x768	60.015	47.712	85.5

(Table) Component Video Timing Chart

No	Signal mode			Horizontal Frequency(KHz)	Dot clock Frequency (MHz)
	Signal name	Resolution	Vertical Frequency(Hz)		
1	576i	720(1440)x576	50	15.63	27
2	480i	720(1440)x480	59.94	15.73	27
3	576P	720x576	50	31.25	27
4	480P	720x480	59.94	31.47	27
5	1080i/50	1920x1080	50	28.13	74.25
6	1080i/60	1920x1080	60	33.75	74.25
7	720P/50	1280x720	50	37.5	74.25
8	720P/60	1280x720	60	45	74.25
9	1080P/50	1920x1080	50	56.25	148.5
10	1080P/60	1920x1080	60	67.5	148.5

(Table) Digital HDMI 1 Video Timing Chart

No	Signal mode			Horizontal Frequency(KHz)	Dot clock Frequency (MHz)
	Signal name	Resolution	Vertical Frequency(Hz)		
1	VGA	640x480	59.94	31.47	25.18
2	576i	720(1440)x576	50	15.63	27
3	480i	720(1440)x480	59.94	15.73	27
4	576P	720x576	50	31.25	27
5	480P	720x480	59.94	31.47	27
6	1080i/50	1920x1080	50	28.13	74.25
7	1080i/60	1920x1080	60	33.75	74.25
8	720P/50	1280x720	50	37.5	74.25
9	720P/60	1280x720	60	45	74.25
10	1080P/24	1920x1080	24	26.973	74.25
11	1080P/25	1920x1080	25	28.125	74.25
12	1080P/30	1920x1080	30	33.75	74.25
13	1080P/50	1920x1080	50	56.25	148.5
14	1080P/60	1920x1080	60	67.5	148.5

NOTE:

- Vertical Frequency : Standard \pm 1Hz
- HDMI 1 can support all of the Analog RGB Video Timing.

APPENDIX

SAFETY NOTE

For correct installing, mounting and uninstalling LCD TV Stand, it is strongly recommended to use a trained, authorized dealer. Failure to follow correct procedures could result in damage to the equipment or injury to the installer.

Uninstalling Stand Base (19")

- 1 Place the LCD TV screen facing down on a flatsurface place where maintained with soft materials (such as a blanket) for protecting the display screen.
- 2 Pull the stand base out from the cabinet after push 6 hooks.(A)
- 3 screwdriver remove screws from stand mounting inserts (B) before installing stand base .(For wall mounting).

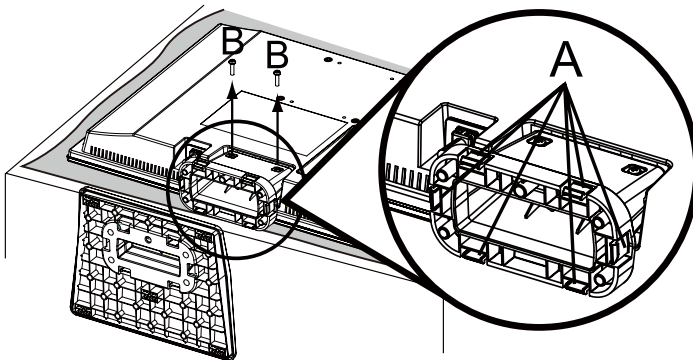

Uninstalling Stand Base (26"/32"/42")

- 1 Place the LCD TV screen facing down on a flatsurface place where maintained with soft materials (such as a blanket) for protecting the display screen.
- 2 Release screw in 4 holes with screw driver.

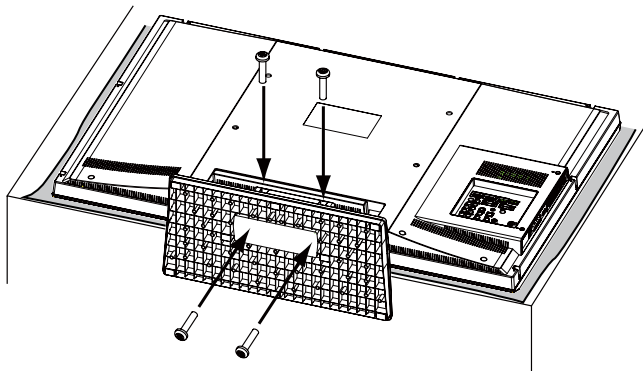

Wall Mounting (optional)

Use the screws that are threaded into the stand-mounting inserts on the back of your HDTV to secure it to a wall mounting. Kit.

NOTE: Wall Mounting kit is not supplied.

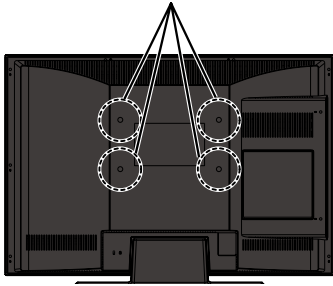

Size	VESA standard interface
19"	100 x 100 mm
26"	100 x 200 mm
32"	200 x 200 mm
42"	200 x 400 mm

Mounting screws measurements:

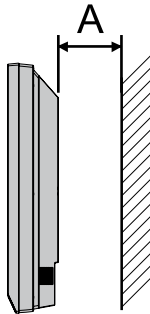

Size	Mounting Screws	Distance between TV and wall(A)
19"	M4 Diameter, Length - 13mm (min.);16mm (max.)	65 mm (min)
26"/32"/42"	M6 Diameter, Length - 13mm (min.);16mm (max.)	60mm (min)

Note

Part No. HDJKTA3200I

[Downloaded From TV-Manual.com Manuals](http://www.tv-manual.com)

Download from [Www.Somanuals.com](http://www.Somanuals.com). All Manuals Search And Download.



SANYO Electronics CO., Ltd.

Free Manuals Download Website

<http://myh66.com>

<http://usermanuals.us>

<http://www.somanuals.com>

<http://www.4manuals.cc>

<http://www.manual-lib.com>

<http://www.404manual.com>

<http://www.luxmanual.com>

<http://aubethermostatmanual.com>

Golf course search by state

<http://golfingnear.com>

Email search by domain

<http://emailbydomain.com>

Auto manuals search

<http://auto.somanuals.com>

TV manuals search

<http://tv.somanuals.com>