



INSTRUCTION MANUAL

LCD-32XR7

LCD TV



**Before connecting, operating or adjusting this product, please read the manual completely.
Please keep this manual for future reference.**

IMPORTANT WARNINGS

- ◆ You **MUST** leave a space of at least 10 cm at the top, bottom, left, right and rear of this TV for ventilation.
- ◆ No naked flame sources, such as lighted candles, should be placed on or above this TV.
- ◆ This TV **SHOULD NOT** be exposed to dripping or splashing and **NO** objects , filled with liquids , such as vases should be placed on the TV.
- ◆ This TV is equipped with a three pin , earthed type power plug and should only be connected to an earthed power outlet. **DO NOT** remove the earth pin , it will compromise this safety feature. If you are unable to plug into the power outlet please contact a qualified electrician.

Table of Contents

Important Safety Precautions	1
Preparations	4
Identification of Controls	6
Connections	9
Basic Operations	14
Memorizing the Channels	16
Setting Picture	19
Setting Sound	20
Stereo / Bilingual Selection	21
Setting Advance	22
Parental Control	24
Adjusting On-Screen Display	25
Adjustment in PC (VGA) Mode	26
Teletext	27
Troubleshooting	28
Care and Maintenance	29
Specifications	30

Important Safety Precautions

Electrical energy can perform many useful functions, but it can also cause personal injuries and property damage if improperly handled. This product has been engineered and manufactured with the highest priority on safety. But **IMPROPER USE CAN RESULT IN POTENTIAL ELECTRICAL SHOCK OR FIRE HAZARD**. In order to prevent potential danger, please observe the following instructions when installing, operating and cleaning the product. To ensure your safety and prolong the service life of your LCD TV product, please read the following precautions carefully before using the product.

- 1. Read these instructions**---All operating instructions must be read and understood before the product is operated.
- 2. Keep these instructions**---These safety and operating instructions must be kept in a safe place for future reference.
- 3. Heed all warnings**---All warnings on the product and in the instructions must be observed closely.
- 4. Follow all instructions**---All operating instructions must be followed.

5. Do not use this apparatus near water---for example, near a bathtub, washbowl, kitchen sink, or laundry tub, in a wet basement, or near a swimming pool, and the like. Do not use immediately after moving from a low temperature to high temperature environment, as this causes condensation, which may result in fire, electric shock, or other hazards.

Apparatus shall not be exposed to dripping or splashing and no objects filled with liquids, such as vases, shall be placed on the apparatus.

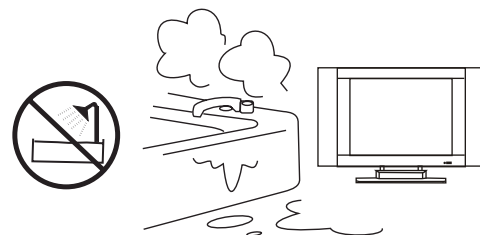

6. Clean only with dry cloth---Unplug this product from the wall outlet before cleaning. Do not use liquid cleaners or aerosol cleaners. Use a damp cloth for cleaning if required.



7. Ventilation---Do not block any ventilation openings. Install in accordance with the manufacturer instructions. The vents and other openings in the cabinet are designed for ventilation. Do not cover or block these vents and openings since insufficient ventilation can cause overheating and/or shorten the life of the product. Do not place the product on a bed, sofa, rug or other similar surface, since they can block ventilation openings. This product is not designed for built-in installation; do not place the product in an enclosed place such as a bookcase or rack, unless proper ventilation is provided or the manufacturer's instructions are followed.

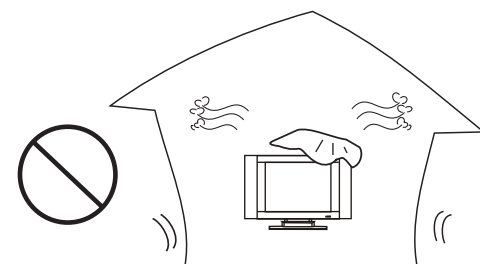

8. Heat sources---Do not install near any heat sources such as radiators, heat registers, stoves, or other apparatus (including amplifiers) that produce heat.

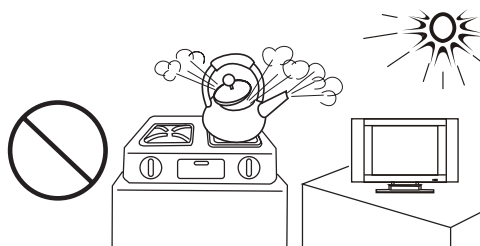

9. Grounding or Polarization---Do not defeat the safety purpose of the polarized or grounding-type plug. A polarized plug has two blades with one wider than the other. A grounding type plug has two blades and a third grounding prong. The wide blade or the third prong are provided for your safety. If the provided plug does not fit into your outlet, consult an electrician for replacement of the obsolete outlet.

10. Power cord protection---Protect the power cord from being walked on or pinched particularly at plugs, convenience receptacles, and the point where they exit from the apparatus.

NOTE: where the mains plug or an appliance coupler is used as the disconnect device, the disconnect device shall remain readily operable.

11. Attachments---Only use attachments/accessories specified by the manufacturer. Do not use attachments not recommended by the manufacturer. Use of improper attachments can result in accidents.

Important Safety Precautions (continued)

12. Stand---Use only with the cart, stand, tripod, bracket, or table specified by the manufacturer, or sold with the apparatus. Do not place the product on an unstable trolley, stand, tripod or table. Placing the product on an unstable base can cause the product to fall, resulting in serious personal injuries as well as damage to the product. When mounting the product on a wall, be sure to follow the manufacturer's instructions. Use only the mounting hardware recommended by the manufacturer.

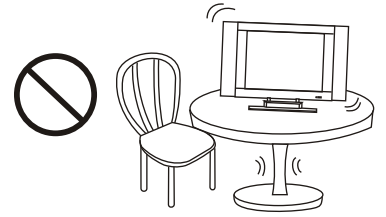

13. Move Carefully---When a cart is used, use caution when moving the cart/apparatus combination to avoid injury from tip-over. Sudden stops, excessive force and uneven floor surfaces can cause the product to fall from the trolley. Never attempt to move the TV unless the AC power cord has been disconnected.



14. Lightning---Unplug this apparatus during lightning storms or when unused for long periods of time.

For added protection for this television equipment during a lightning storm, or when it is left unattended and unused for long periods of time, unplug it from the wall outlet and disconnect the antenna. This will prevent damage to the equipment due to lightning and power-line surges.

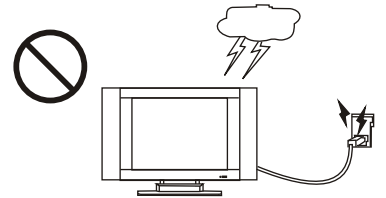

15. Servicing---Refer all servicing to qualified service personnel. Servicing is required when the apparatus has been damaged in any way, such as power-supply cord or plug is damaged, liquid has been spilled or objects have fallen into the apparatus, the apparatus has been exposed to rain or moisture, does not operate normally, or has been dropped.

16. Replacement parts---In case the product needs replacement parts, make sure that the service person uses replacement parts specified by the manufacturer, or those with the same characteristics and performance as the original parts. Use of unauthorized parts can result in fire, electric shock and/or other danger.

17. Overloading---Do not overload wall outlets, extension cords, or convenience receptacles on other equipment as this can result in a risk of fire or electric shock.

18. Entering of objects and liquids---Never insert an object into the product through vents or openings. With high voltage in the product, inserting an object can cause electric shock and/or short internal parts. For the same reason, do not spill water or liquid on the product.

19. Damage requiring service---If any of the following conditions occurs, unplug the power cord from the AC outlet, and request a qualified service person to perform repairs.

- When the power cord or plug is damaged.
- When a liquid is spilled on the product or when objects have fallen into the product.
- When the product has been exposed to rain or water.
- When the product does not operate properly as described in the operating instructions.

Do not touch the controls other than those described in the operating instructions. Improper adjustment of controls not described in the instructions can cause damage, which often requires extensive adjustment work by a qualified technician.

- If the product has been dropped or the cabinet has been damaged in any way.
- When the product displays an abnormal condition or exhibits a distinct change in performance. Any noticeable abnormality in the product indicates that the product needs servicing.

20. Safety checks---Upon completion of service or repair work, request the service technician to perform safety checks to ensure that the product is in proper operating condition.

21. Wall or ceiling mounting---When mounting the product on a wall or ceiling, be sure to install the product according to the method recommended by the manufacturer. This is a safety feature.

Important Safety Precautions (continued)

22. Power source---This product is intended to be supplied by a listed power supply indicated on the marking label. If you are not sure of the type of power supply to your home, consult your product dealer or local power company. For added protection for this product during a lightning storm, or when it is left unattended and unused for long periods of time, unplug it from the wall outlet and disconnect the cable system. This will prevent damage to the product due to lightning and power line surges. When the unit has to be used with another power supply voltage, the power cable must be changed. Consult your product dealer. The socket outlet should be installed near the equipment and easily accessible. Use only the power cord designated by our dealer to ensure safety and EMC. When connecting other products such as VCRs and personal computers, you should turn off the power of the unit for protection against electric shock.

23. Panel protection---The LCD panel used in this product is made of glass. Therefore, it can break when the product is dropped or impacted upon by other objects. Be careful not to be injured by broken glass pieces in case the LCD panel breaks.

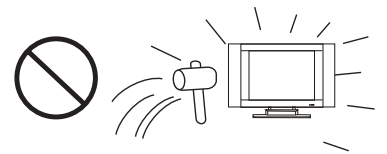

24. Pixel defect---The LCD panel is a very high technology product, giving you finely detailed pictures. Occasionally, a few non-active pixels may appear on the screen as a fixed point of blue, green or red. Please note that this does not affect the performance of your product.

- An outside antenna system should not be located in the vicinity of overhead power lines or other electric light or power circuits, or where it can collide with such power lines or circuits. When installing an outside antenna system, extreme care should be taken to keep from touching such power lines or circuits, as contact with them might be fatal.

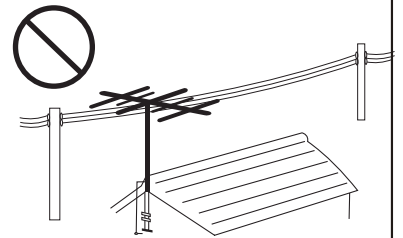

WARNING: For continued safety, apparatus with class I construction shall be connected to a mains socket outlet with a protective earthing connection.

Preparations

Using the Remote Control

- Use the remote control by pointing it towards the remote sensor window of the set. Objects between the remote control and sensor window may prevent proper operation.

Note: This illustration is for reference only. The remote sensor may be in different locations on different models.

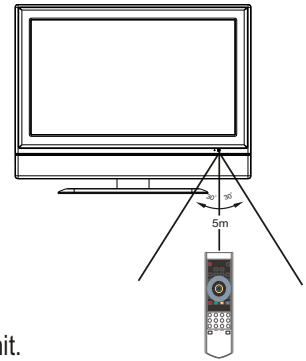

Cautions regarding use of remote control

- Do not expose the remote control to shock. In addition, do not expose the remote control to liquids, and do not place in an area with high humidity.
- Do not install or place the remote control under direct sunlight. The heat may cause deformation of the unit.
- The remote control may not work properly if the remote sensor window of the main unit is under direct sunlight or strong lighting. In such a case, change the angle of the lighting or LCD TV set, or operate the remote control closer to the remote sensor window.

Batteries for the Remote Control

If the remote control fails to operate the LCD TV functions, replace the batteries in the remote control.

1 Open the battery cover.

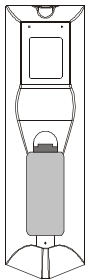

2 Insert two size-AAA batteries.

- (Place the batteries with their terminals corresponding to the (+) and (-) indications in the battery compartment.)

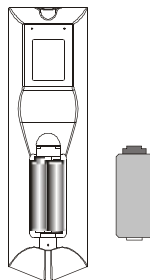

3 Replace the cover.

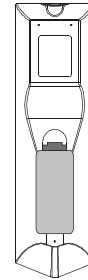

Precaution on battery use

Improper use of batteries can result in a leakage of chemicals and/or explosion. Be sure to follow the instructions below.

- Place batteries with their terminals corresponding to the (+) and (-) indications.
- Different types of batteries have different characteristics. Do not mix batteries of different types.
- Do not mix old and new batteries. Mixing old and new batteries can shorten the life of new batteries and/or cause old batteries to leak chemicals.
- Remove batteries as soon as they are non-operable. Chemicals that leak from batteries can cause a rash. If chemical leakage is found, wipe with a cloth.
- If the remote control is not used for an extended period of time, remove the batteries from the remote control.
- The batteries (battery pack of batteries installed) shall not be exposed to excessive heat such as sunshine, fire or the like.

Power Connection

Insert the AC plug into a conveniently located AC outlet.

Note:

- This product should be operated only from the type of power source indicated on the marking label.
- Always unplug the AC cord from power outlet when not using for a long period of time.

Preparations (continued)

Antenna Connection

INSTALL the unit in a room where direct light will not fall upon the screen. Total darkness or a reflection on the picture screen may cause eyestrain. Soft and indirect lighting is recommended for comfortable viewing.

Optimum reception of colour requires a good signal and will generally mean that an outdoor antenna must be used. The exact type and position of the antenna will depend upon your particular area.

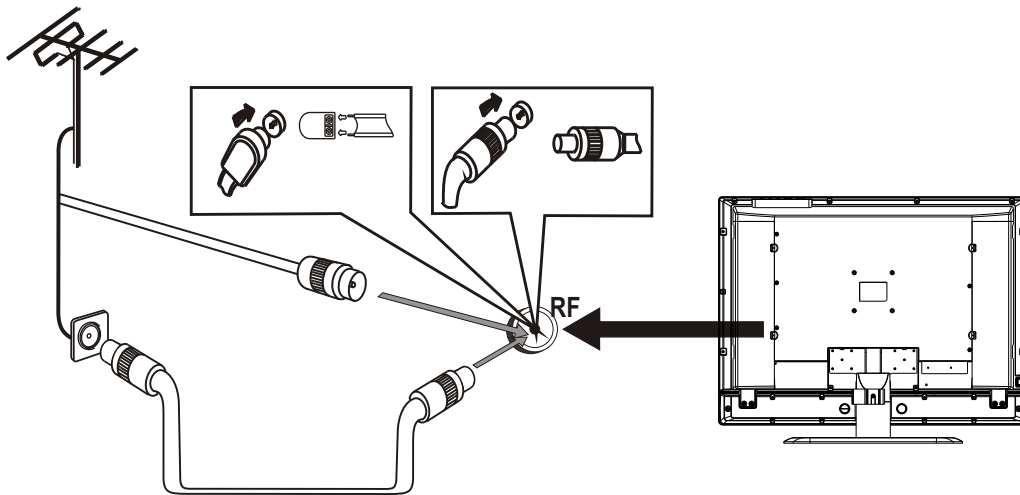

Note:

It is recommended that the 75-ohm coaxial cable be used to eliminate interference and noise which may occur due to radio wave conditions. The antenna cable should not be bundled with the power cord and the like.

Speaker connection

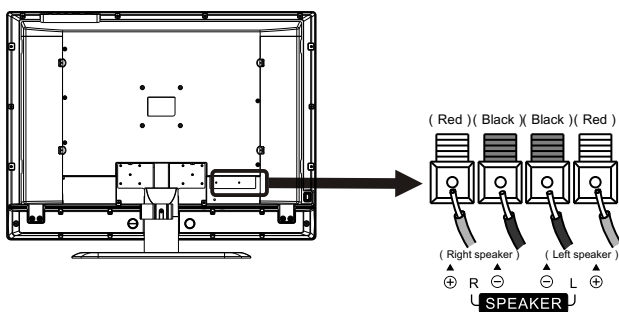

Connect the speaker audio cable to the external speaker output jack on the unit matching the "+" and "-" ends of the cable with color.

Note:

- ▶ Unplug the LCD display and all connected component before connecting the speakers.
- ▶ The illustration may be different depending on model.

Identification of Controls

Main Unit

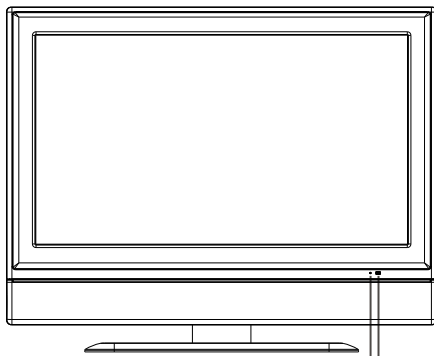

Remote Sensor
Power Indicator

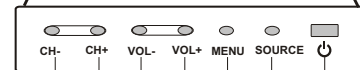
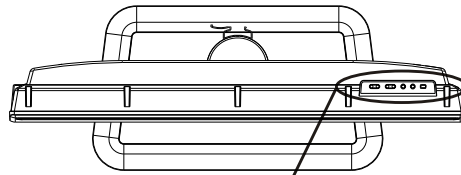

Channel Down/Up
Volume Down/Up
Menu
Select Input Signal
Power On/Standby

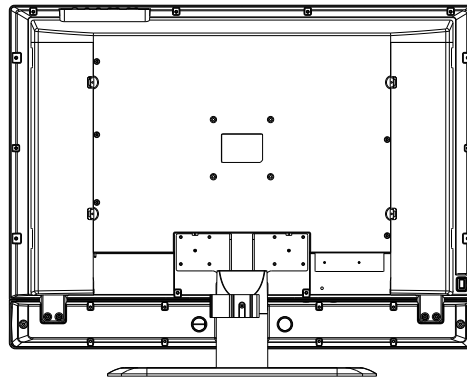

Power Switch

1. POWER

Press this button to turn the unit ON from STANDBY mode. Press it again to turn the set back to STANDBY.

2. SOURCE

To access signal source select menu

3. MENU

Press this button to access the Menu main page

4. VOL+/-

Press the **VOL+** or **VOL-** button to directly increase or decrease the sound volume level;
In OSD Menu, press these buttons to adjust the value or setting of each item.

5. CH+/-

Press these two buttons to directly change the TV channel;
In OSD Menu, press these buttons to choose the OSD item.

Note:

Functions of **VOL+/-**, **CH+/-**, **MENU**, **SOURCE** and **POWER**  are also provided to the remote control. This operation manual provides a description based on operating functions with the remote control.

OSD means On Screen Display.

Identification of Controls (continued)

Main Unit

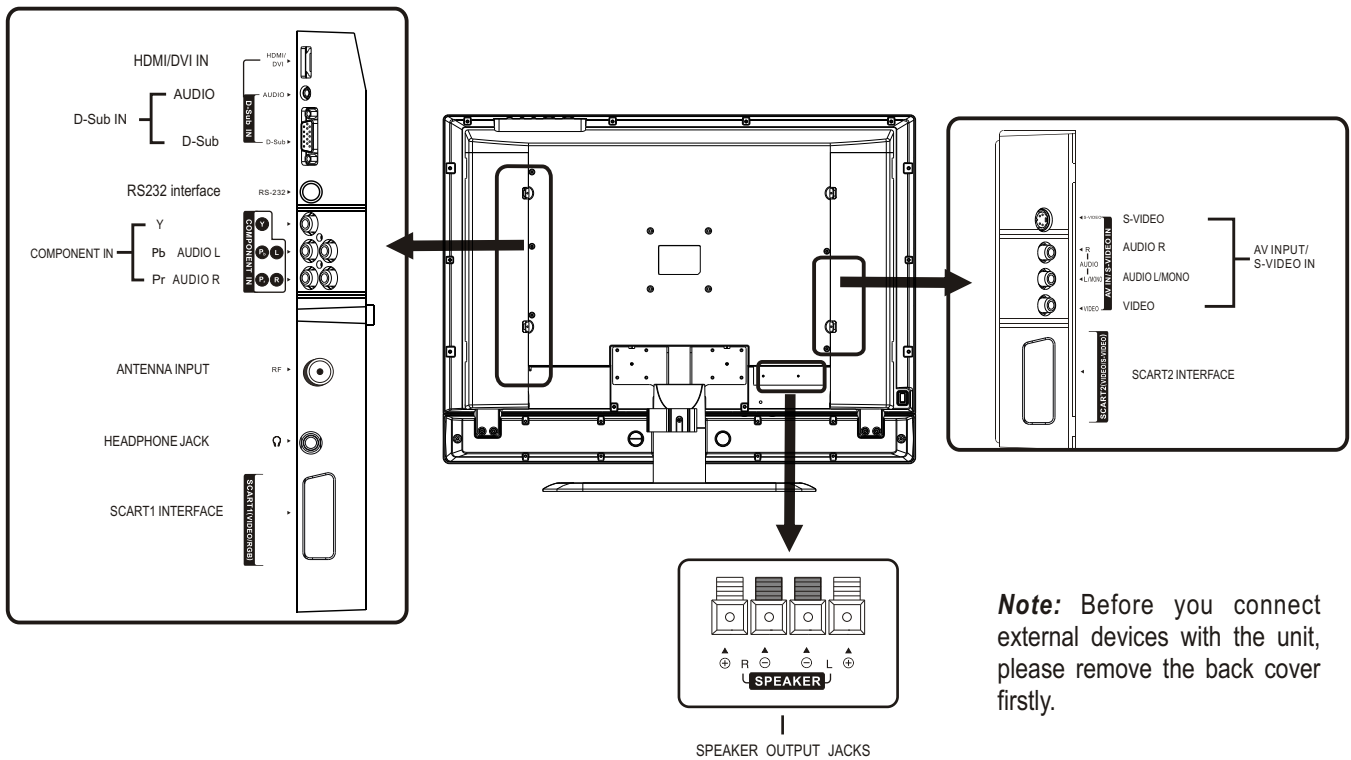

Note: Before you connect external devices with the unit, please remove the back cover firstly.

1. AV inputs (Video, Audio L/MONO, R) / S-Video input

Receive video/audio signals from external sources such as VCR or DVD player.

Receive a S-Video signal from external source such as VCR or DVD player.

2. 21-pin Euro-SCART2 (VIDEO/S-VIDEO) interface

3. HDMI/DVI interface

4. D-Sub input/Audio in

Connect to the D-Sub /audio output sockets on your PC.

5. RS232 interface

For service use only. The user cannot operate the unit through the **RS232** interface.

6. Component inputs (Y, Pb, Pr, Audio L, R)

Connect to the component and audio output sockets of a DVD player or Set-Top Box.

7. Antenna input

Allows you to connect cable or outdoor antenna.

8. Headphone jack

9. 21-pin Euro-SCART1 (VIDEO/RGB) interface

Identification of Controls (continued)

Remote Control



- 1. POWER** Turn the unit on or off
- 2. Teletext** To enter or exit teletext mode (Teletext)
- 3. Hold** To hold the current teletext page temporarily (Teletext)
- 4. Reveal** To display hidden information such as solution to riddles and puzzles (Teletext)
- 5. Menu** To access the menu main page
- 6. CH+/- (▲ / ▼), VOL+/- (◀ / ▶), OK**
CH+/- (▲ / ▼)
 To select channels upward or downward; to move upward or downward in menu operation;
VOL+/- (◀ / ▶)
 Used to adjust volume
 To move left or right in menu operation; to adjust selected menu item when in menu operation;
OK button: To exit the on-screen menu.
- 7. Source** To access source select menu
- 8. Stereo** To select stereo, mono or bilingual; RED button (Teletext)
- 9. Sleep** To set sleep timer; GREEN button (Teletext)
- 10. 0-9 number** Use these number buttons to select channel or input password
- 11. P.Mode** To select the picture mode
- 12. Clock** To display the real time on the screen while viewing TV program which carries a teletext broadcasting
- 13. Size** To expand top half or bottom half page of current screen (Teletext)
- 14. Index** To display the main index (Teletext)
- 15. Mix** To superimpose text on a TV picture (Teletext)
- 16. Mute** To temporarily mute the sound
- 17. Zoom** To select screen aspect ratio
- 18. Auto** To rectify the picture automatically in VGA mode; BLUE button (Teletext)
- 19. Still** To freeze current picture; YELLOW button (Teletext)
- 20. Display** To display channel status or signal information
- 21. Return** To quickly return to the previous channel
- 22. S.Mode** To select the sound mode

Connections

Cautions before connecting

- Carefully check the terminals for position and type before making any connections.
- The illustration of the external equipment may be different depending on your model.
- Loose connectors can result in image or colour problems. Make sure that all connectors are securely inserted into their terminals.
- Refer to the operating manual of the external device as well.
- When connecting an external device, turn the power off to avoid any issues.

Connect a Decoder

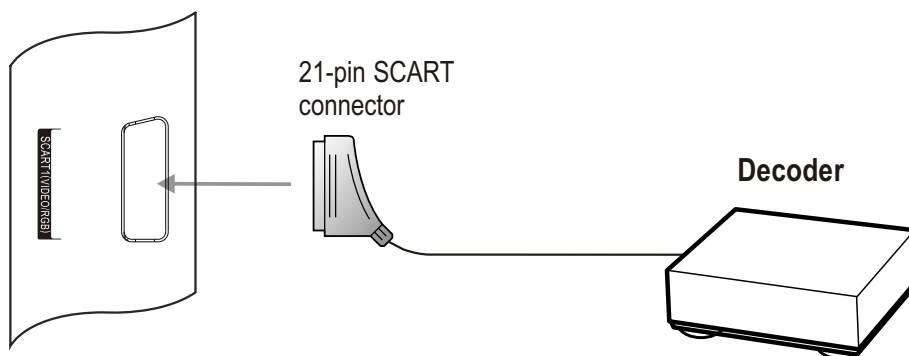

How to connect:

Connect the SCART Cable between the unit and the Decoder.

To watch Decoder

1. Turn on your LCD TV , press **SOURCE** button on the remote control.
2. Use **▲** or **▼** repeatedly to select **SCART 1** and press **◀** or **▶** to confirm.
3. Turn on your Decoder.

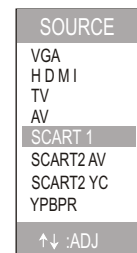

Note:

1. The unit receives **CVBS (VIDEO)** signal and **RGB** signal from **SCART1** interface and is able to identify the signal format automatically. The unit chooses the **RGB** signal prior to the **CVBS (VIDEO)** signal.
2. To connect to external devices with AV terminals, you may use 21-pin Scart Converter to connect to SCART interface on the unit , and the unit receives **CVBS (VIDEO)** signal only.

Connections (continued)

Connect a VCR

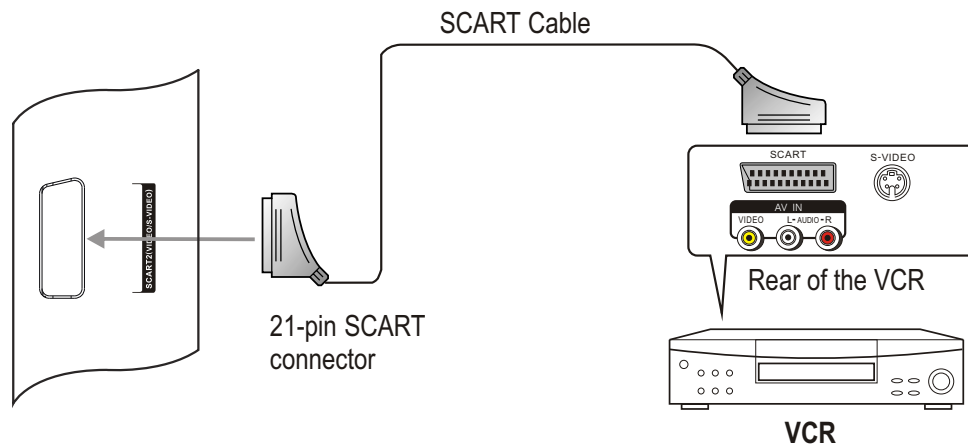

How to connect:

Connect the SCART Cable between the unit and the VCR.

To play VCR

1. Turn on your LCD TV , press **SOURCE**  button on the remote control.
2. Use **▲** or **▼** repeatedly to select **SCART2 AV** and press **◀** or **▶** to confirm.
3. Turn on your VCR , insert a videotape and press the Play button.

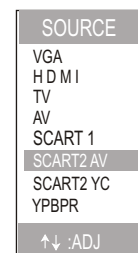

Note:

- The unit receives **CVBS (VIDEO)** signal and **Y/C (S-VIDEO)** signal from **SCART2** interface.
- When receiving **Y/C** signal, you need to select **SCART 2 YC** instead of **SCART 2 AV** in the source select menu. Therefore, if you find that the colour is not properly displayed, please try to select **SCART 2 YC**.
- To connect to external devices with AV terminals, you may use 21-pin Scart Converter to connect to SCART interface on the unit, then please select **SCART 2 AV** and the unit receives **CVBS (VIDEO)** signal only.

Connections (continued)

Connect AV or S-Video inputs

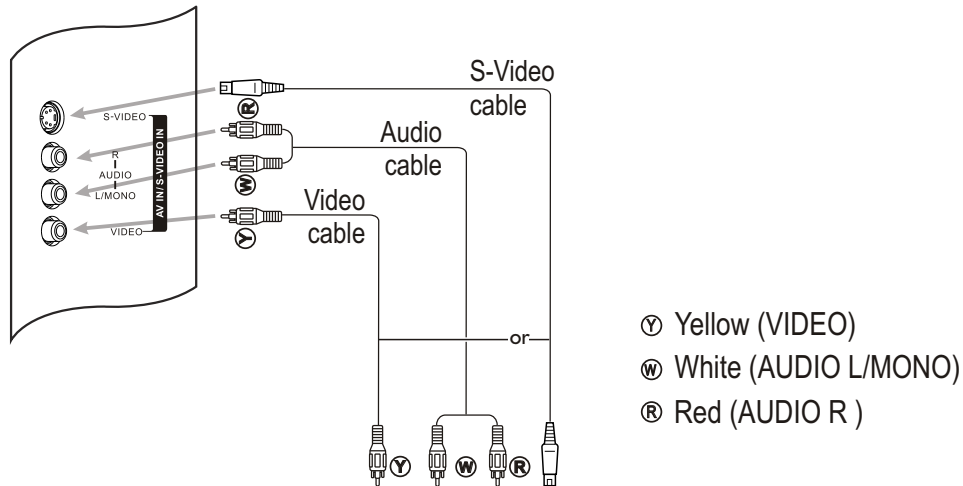

Examples of external devices that can be connected



VCR

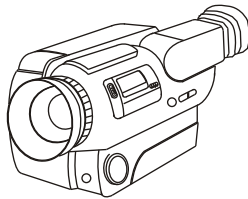

Video Camera

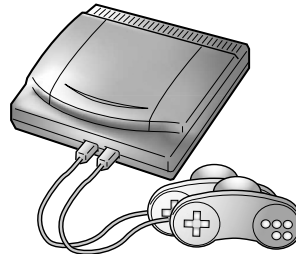

Home video game system

The unit provides Audio/Video inputs for you to connect external devices such as VCR, Video Camera or Home video game system.

How to connect:

Connect the Audio/Video cables between the Audio (L/R)/Video jacks on the unit and external devices.

To view signal from AV/S-VIDEO inputs

1. Turn on your LCD TV, press **SOURCE** button on the remote control.
2. Use **▲** or **▼** repeatedly to select **AV** (or **AV/SV** if the S-Video terminal is connected) and press **◀** or **▶** to confirm.
3. Turn on the external device and play it.

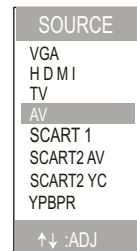

Note:

For better video, you can use the **S-Video** terminal if your source supports it. The **S-Video** is prior to **Video** terminal when they are connected at the same time. To view picture from the **Video** terminal, disconnect any plug from the **S-Video** terminal.

The **Video** input terminal on the **AV IN** and the **S-Video** input terminal share the same **Audio** input terminals.

Connections (continued)

Connect a DVD player

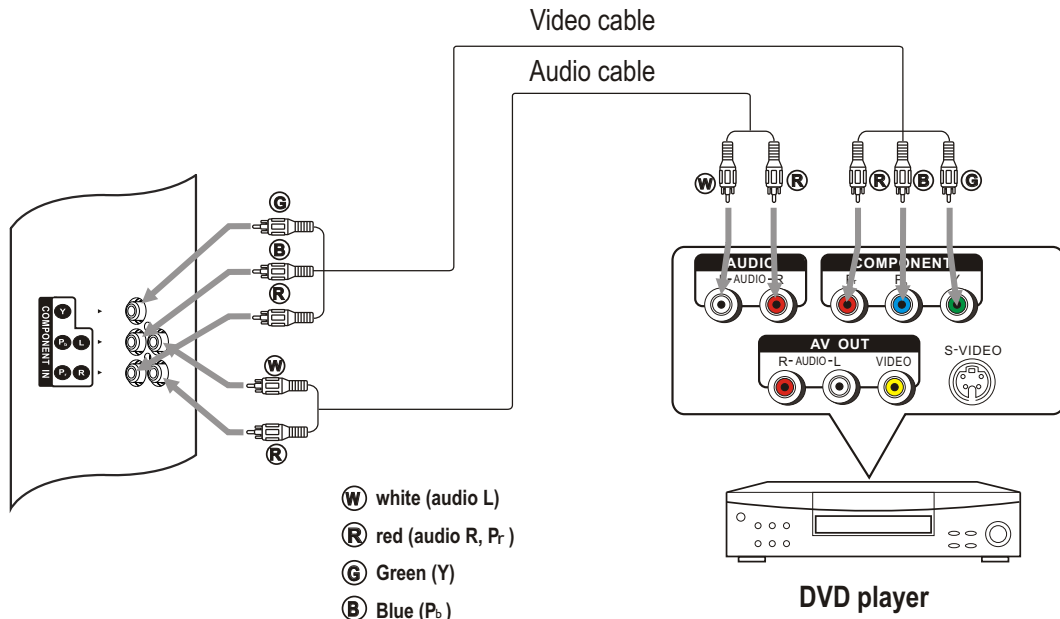

How to connect a DVD Player using Component Video Connections:

Connect the Video cable between the Y, Pb, Pr input jacks on the unit and Y, Pb, Pr output jacks on the DVD player.

Connect the Audio cable between the AUDIO input jack on the unit and AUDIO output jacks on the DVD player.

To play DVD

1. Turn on your LCD TV, press **SOURCE** button on the remote control.
2. Use **▲** or **▼** repeatedly to select **YPBPR** and press **◀** or **▶** to confirm.
3. Turn on your DVD player, insert a DVD disc and press the Play button.

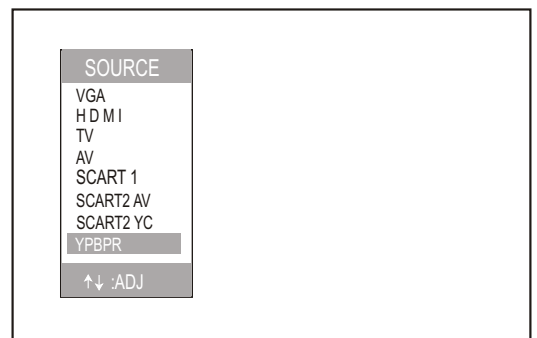

Note:

The Y, Pb, Pr outputs on your DVD player are sometimes labeled Y, Cb, Cr or Y, B-Y, R-Y. If so, connect the cables to like colours.

Connections (continued)

Connect a HDMI device

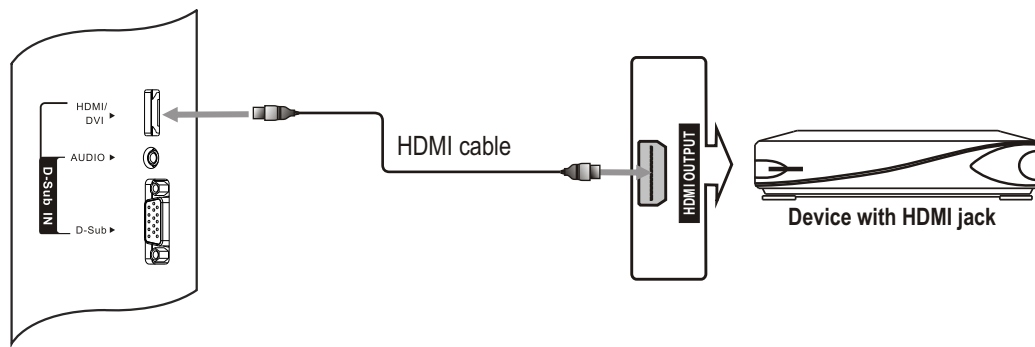

How to connect:

Connect the HDMI cable between the HDMI input jack on the unit and HDMI output jack on the product.

Note:

The HDMI Sources are compatible with DVI displays through the use of a passive cable converter. So you may connect product with DVI output jack to the unit. Connect a passive cable converter between the HDMI input jack on the unit and DVI output jack on the product. Connect an Audio cable between the AUDIO output on your product and AUDIO input jack of **D-Sub IN** on the unit.

To Play the Device

1. Turn on your LCD TV , press **SOURCE** button on the remote control.
2. Use **▲** or **▼** repeatedly to select **HDMI** and press **◀** or **▶** to confirm.
3. Turn on your device.

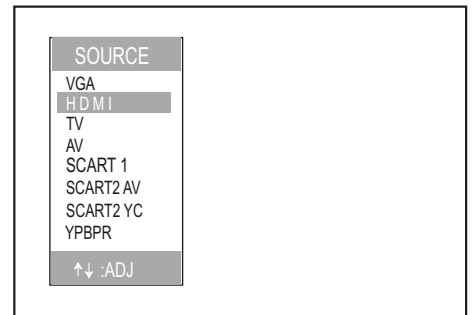

Connect a PC

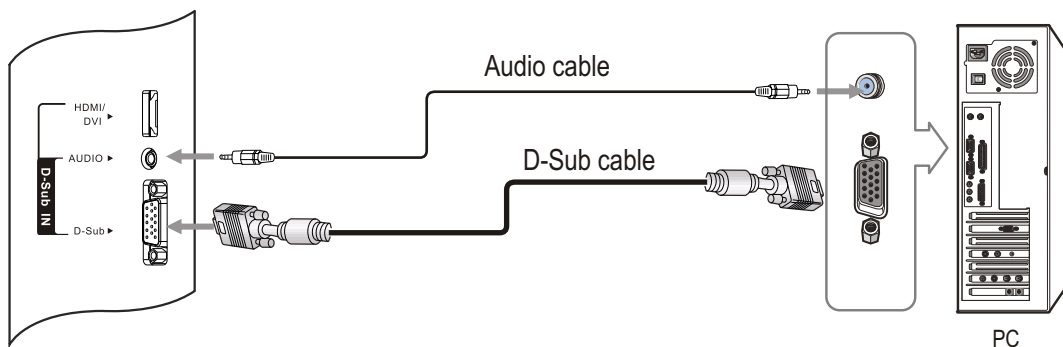

How to connect:

Connect a D-Sub cable between the D-Sub interface on the PC and the D-Sub interface on the unit.
Connect an Audio cable between the AUDIO output on the PC and AUDIO input socket on the unit.

To Watch the PC screen

1. Turn on your LCD TV , press **SOURCE** button on the remote control.
2. Use **▲** or **▼** repeatedly to select **VGA** and press **◀** or **▶** to confirm.
3. Turn on your PC and check for PC system requirements.
4. Adjust the PC screen.

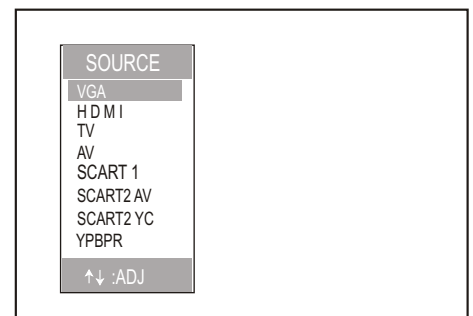

Basic Operations

Turning the Unit On and Off

Turning On

Insert the power cord into the wall outlet, press the **Power Switch** on the unit to power on.
If the unit is in STANDBY mode, press the **Power** ⏻ button on the remote control to turn on the unit.

Turning Off

With the power on, press the **Power** ⏻ button on the remote control to turn off.
If you would like to cut off the power completely, press the **Power Switch** directly.

Note:

You can also use the **Power** ⏻ button on the Control panel on the main unit.
After you turn off the TV, you should wait for some seconds to turn the TV on again .

Viewing the Menus and Displays

Your LCD TV has a simple, easy-to-use menu system that appears on the screen. This system makes it convenient and fast to use features on the unit. The unit also lets you display the status of many of your LCD TV features.

Viewing the Menus

- 1 With the power on, press the **MENU** button on the remote control. The main menu appears on the screen.
- 2 Press ◀ or ▶ to select menu page, and press ▼ to access.
- 3 Use the ▲ or ▼ to select menu item and ◀ or ▶ to adjust value or setting of the item.
- 4 Press **OK** button to exit the menu or press **MENU** button to return to the previous menu.

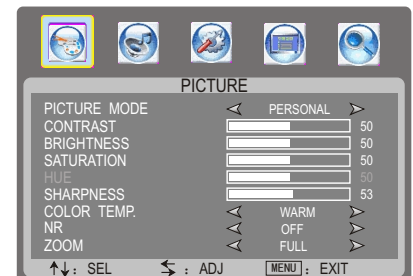

Note:

To clearly introduce the menu operations , this operation manual provides a description based on operation with the remote control.

Displaying Status Information

Press the **DISPLAY** ⏻ button on the remote control, the unit will display current status information such as channel number, audio mode or signal source, etc.

Basic Operations (continued)

Changing Channels

Using the Channel Buttons (CH+ or CH-)

Press the **CH+** or **CH-** to change channels.

When you press the **CH+** or **CH-**, the unit changes channels in sequence. You will see all the channels that the unit has memorized. You will not see channels that were skipped.

Direct Accessing Channels

Press the **number buttons** to go directly to a channel.

To select a one-digit channel: press the **0-9 number buttons** to input the channel number, followed by **OK** button or wait for some seconds, and the unit automatically goes to the selected channel.

To select a two-digit channel: press the **0-9 number buttons** to input the channel number and the unit goes to the selected channel.

To select a three-digit channel: press the **0-9 number buttons** to input the channel number and the unit goes to the selected channel.

Note:

When you use the number buttons, you can directly select channels that were skipped.

Using the RETURN ⇌ button

Press this button to switch between the current channel and the previous channel.

Selecting Input Source Signal

1 Press the **SOURCE** button to display the **SOURCE** menu.

2 Press **▲** or **▼** to select a desired input source.

3 Press **◀** or **▶** to confirm.

VGA-----Select signal from VGA (D-SUB) jack.

HDMI-----Select signal from HDMI/DVI terminals.

TV -----Select TV signal.

AV(or AV/SV)-----Select signal from AV IN or S-Video terminals.

SCART 1-----Select signal from 21-PIN SCART 1 interface.

SCART2 AV-----Select signal from 21-PIN SCART 2 interface.

SCART2 YC-----Select SCART2 YC when viewing Y/C signal from 21-PIN SCART 2 interface.

YPBPR-----Select signal from YPbPr terminal.

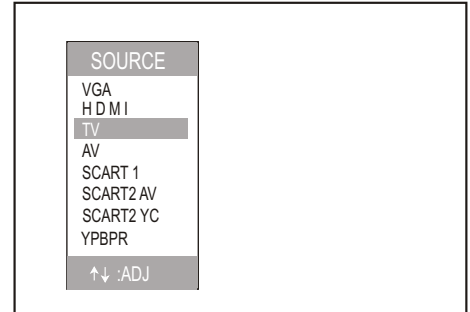

Selecting a Menu Language

1 Press **MENU** to display the menu main page.

2 Press **◀** or **▶** repeatedly to select **SYSTEM** menu.

3 Press **▼** to access the menu.

The **[OSD LANGUAGE]** item will be highlighted automatically.

4 Press **◀** or **▶** to access the selection bar, and then use **◀** or **▶** to select a desired OSD language.

5 Press **OK** button to exit the menu or press **MENU** button to return to the previous menu.

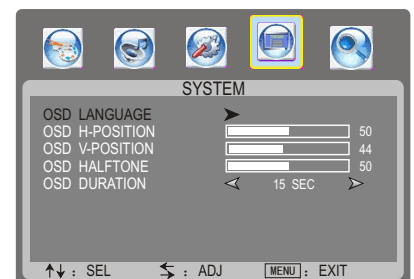

Memorizing the Channels

Your LCD TV can memorize and store all of the available channels. After the available channels are memorized, use CH+/- to scan through the channels.

Selecting a Region

Before you start **AUTO SCAN**, it is necessary to select a region firstly.

- 1 Press **MENU** to display the menu main page.
- 2 Press **◀** or **▶** repeatedly to select **TV-CHANNEL** menu, and press **▼** to access.
- 3 Press **▲** or **▼** repeatedly to select **PROGRAM AREA** item.
- 4 Press **◀** or **▶** to select a proper region according to your area.
- 5 Press **OK** button to exit the menu or press **MENU** button to return to the previous menu.



Searching Channels Automatically

- 1 Navigate to the **TV-CHANNEL** menu, and highlight **AUTO SCAN** item.
 - 2 Press **◀** or **▶** to begin the auto channel search.
- The unit will begin memorizing all of the available channels.

If there is any channel locked, you must first input your password to perform the auto channel search.

Note: During the process of the Auto Scan, you can press **OK** or **MENU** button to stop the search.

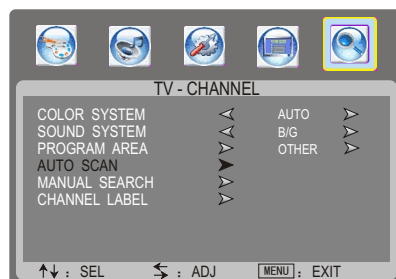

Searching Channels Manually

Use **Manual Search** if desired channels can not be memorized or if you would like to store programs to specific channel numbers one by one.

- 1 Use **0-9 number buttons** to directly select a channel that you want to perform manual search.
- 2 Navigate to the **TV-CHANNEL** menu, and highlight **MANUAL SEARCH** item.
- 3 Press **▶** to access the next level menu.
- 4 Press **▲** or **▼** to select **FREQUENCY** item. You may press **0-9 number buttons** to input a frequency directly or press **◀** or **▶** to search program from current frequency.

To search program manually by inputting a frequency:

1. Highlight the **FREQUENCY** item, the unit allows you to input a frequency.
2. Input the desired frequency by using **0~9 number buttons**, then the unit locates to your frequency.

= Or =

To search program manually from current frequency:

- Press **▶**, the set searches towards higher frequency.
Press **◀**, the set searches towards lower frequency.

The search stops when a program is found and this program will be stored in current channel.

If there is any channel locked, you cannot access the manual search submenu unless you input the correct password.

After the Manual Search, you can press **OK** button to exit the menu or press **MENU** button to return to the previous menu.

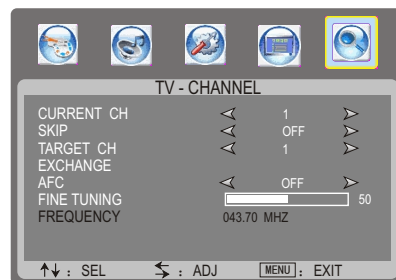

Memorizing the Channels (continued)

Manual Fine Tuning

- 1 Press **MENU** to display the menu main page.
- 2 Press **◀** or **▶** repeatedly to select **TV-CHANNEL** menu, and press **▼** to access.
- 3 Press **▲** or **▼** repeatedly to select **MANUAL SEARCH** item, and press **▶** to access.
- 4 Press **▲** or **▼** to select **FINE TUNING** item.
- 5 Press and hold **◀** or **▶** to fine tune till the best possible picture and sound are obtained.
If you fine-tune a program manually, the AFC will be turned off automatically.

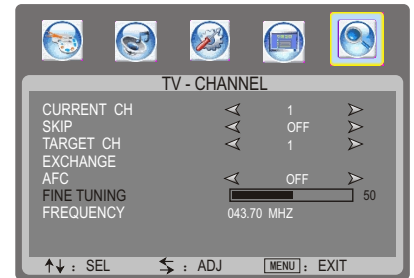

Setting Auto Frequency Control (AFC)

- 1 Navigate to the **MANUAL SEARCH** submenu, and highlight **AFC** item.
- 2 Press **◀** or **▶** to select **ON** or **OFF**.
- 3 Press **OK** button to exit the menu or press **MENU** button to return to the previous menu.
When the AFC is set to ON, the unit will automatically tune the program frequency to provide the best possible picture and sound.

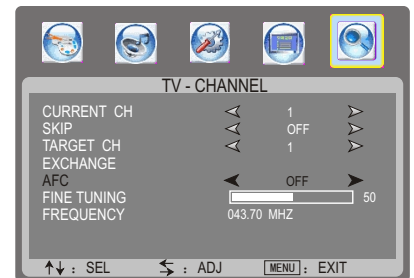

Skipping Channels

- 1 Use channel buttons to select a channel you want to skip.
- 2 Navigate to the **MANUAL SEARCH** submenu, and highlight **SKIP** item.
- 3 Press **◀** or **▶** to select **ON** or **OFF**.
When the item is set to ON, the selected channel will be skipped.
When the item is set to OFF, the selected channel will not be skipped.
- 4 Press **OK** button to exit the menu or press **MENU** button to return to the previous menu.

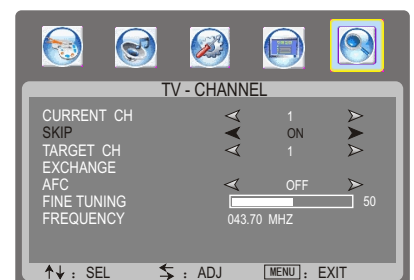

The skipped channels can not be selected by using CH+/- buttons unless you use number buttons to input channel number directly.

Memorizing the Channels (continued)

Editing Channels

The **EXCHANGE** function is for you to arrange channel order as you wish.

- 1 Navigate to the **MANUAL SEARCH** sub menu.
Highlight the **CURRENT CH** item, use ◀ or ▶ to select a channel number you want to exchange.
- 2 Highlight **TARGET CH** item, use ◀ or ▶ to select a target channel number you want to exchange.
- 3 Press ▲ or ▼ to select **EXCHANGE** item, and press ◀ or ▶ to exchange contents in current channel and the target channel.

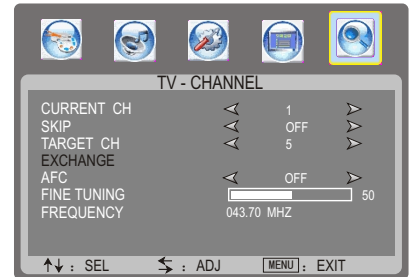

Editing Channel Label

- 1 Navigate to the **TV-CHANNEL** menu, and highlight **CHANNEL LABEL** item .
- 2 Press ◀ or ▶ to access the channel label menu.
- 3 Within the menu, use ▲, ▼, ◀ or ▶ to select channel number you want to edit.
- 4 Press the **Stereo** button(**RED** button) on the remote control to start to input characters.
Use ◀ or ▶ to move cursor left or right.
Use ▲ or ▼ to select characters.

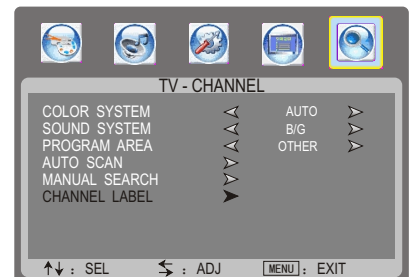

After finishing inputting, you may press the **Stereo** button(**RED** button) to confirm, or **Sleep** button(**GREEN** button) to cancel, or **Still** button(**YELLOW** button) on the remote control to clear the input.
The maximum length of program name is 5 characters.

- 5 Press **OK** button to exit the menu or press **MENU** button to return to the previous menu.

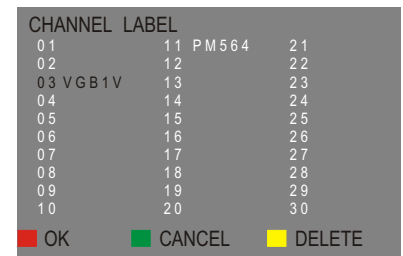

Setting Color/Sound System

- 1 Press **MENU** to display the menu main page.
- 2 Press ◀ or ▶ repeatedly to select **TV-CHANNEL** menu, and press ▼ to access.
- 3 Press ▲ or ▼ repeatedly to select **COLOR SYSTEM** or **SOUND SYSTEM** item.
- 4 Press ◀ or ▶ to select a proper color system(normally please select AUTO) or sound system.
- 5 Press **OK** button to exit the menu or press **MENU** button to return to the previous menu.

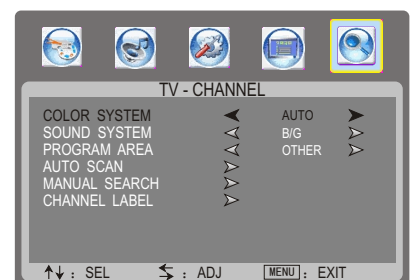

Setting Picture

Customizing the Picture

- 1 Press **MENU** to display the **PICTURE** menu, and press **▼** to access.
- 2 Within the menu, use **▲**, **▼**, **◀** or **▶** to navigate or adjust.
- 3 Press **OK** button to exit the menu or press **MENU** button to return to the previous menu.



Note: The above menu is shown as an example. The menu items may be different when the unit works in different mode.

Option	Function	Choice/remarks
Picture Mode	Selects a desired picture mode.	Personal/Standard/Dynamic/Soft Note: you may directly press P.Mode button on the remote control to select.
Contrast	Adjusts image contrast.	▶ : stronger ◀ : weaker
Brightness	Adjusts screen brightness for easier viewing of dark picture such as night scenes and black hair.	▶ : lighter ◀ : darker
Saturation	Adjusts color saturation.	▶ : stronger ◀ : weaker
Hue	Adjusts color hue for image.	▶ : greenish ◀ : purplish
Sharpness	Adjusts image sharpness and displays a sharp image.	▶ : sharper ◀ : softer
Color Temperature	Selects one of three automatic color adjustments. Sets to warm to enhance hotter colors such as red, or set to cool to see less intense colors with more blue.	Normal/Warm/Cool
NR	Reduces noise in the picture, commonly called snow.	Off/Weak/Middle/Strong
Zoom	Adjusts screen aspect ratio.	Normal/Panorama/Auto/Full/Zoom1/Zoom2 Note: you may directly press Zoom button on the remote control to select.

Note: The Hue item is for NTSC system.

The Hue item is also adjustable when the signal is YPBPR and the frequency is 60Hz.

Freezing picture

Press the **STILL** button to hold on the image on the screen (the video sources still run).
Press it again to reactivate the image.

Note: For the sake of protecting the screen, please do not freeze a picture for a long time.

Setting Sound

Adjusting the Volume

Using the volume buttons (VOL+ and VOL-)

Press the **VOL +** or **VOL-** to increase or decrease the volume.

Using the MUTE button

At any time, you can temporarily cut off the sound using the **MUTE** button.

- 1 Press the **MUTE** button and the sound cuts off.
- 2 To turn mute off, press the **MUTE** button again.

Customizing the Sound

- 1 Press **MENU** to display the menu main page.
- 2 Press **◀** or **▶** repeatedly to select **SOUND** menu, and press **▼** to access.
- 3 Within the menu, use **▲**, **▼**, **◀** or **▶** to navigate or adjust.
- 4 Press **OK** button to exit the menu or press **MENU** button to return to the previous menu.

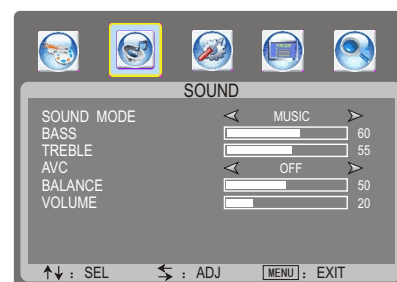

Option	Function	Choice/Remarks
Sound Mode	Selects sound mode.	Personal/Standard/News/Music Note: you may directly press S.Mode button on the remote control to select.
Bass	Adjusts Bass (low sounds)	▶ : stronger ◀ : weaker
Treble	Adjusts Treble (high sounds)	▶ : stronger ◀ : weaker
AVC (Auto Volume Control)	Select "ON" to equalize overall volume levels across all channels.	ON/OFF
Balance	Adjusts volume balance (left and right volumes)	▶ :Higher volume from right speaker. ◀ :Higher volume from left speaker.
Volume	Adjusts volume	▶ : stronger ◀ : weaker

Stereo/Bilingual Selection

You can quickly select sound multiplex mode by using the **Stereo** button on the remote control.

- **NICAM Broadcast Selection**

This enables the selection of the reception mode when receiving a NICAM signal. To let you enjoy NICAM broadcasting, this TV set receives NICAM system stereo, bilingual, and monaural broadcasts.

Stereo

When the TV set is receiving a stereo broadcast, press the **Stereo** button to select **NICAM STEREO** or **NICAM MONO**.
When **NICAM MONO** is selected, the TV sound is output monaurally.

Bilingual

When the TV set is receiving a bilingual program, press the **Stereo** button to select **NICAM DUAL A** or **NICAM DUAL B**.

- **IGR (German stereo system) Broadcasts**

This enables the selection of the reception mode when receiving an IGR signal. To let you enjoy IGR broadcasting, this TV set receives IGR system stereo and bilingual broadcasts.

Stereo

When the TV set is receiving a stereo broadcast, press the **Stereo** button to select **STEREO** or **MONO**.
When **MONO** is selected, the TV sound is output monaurally.

Bilingual

When the TV set is receiving bilingual program, press the **Stereo** button to select **DUAL A** or **DUAL B**.

Setting Advance

Setting Clock Time

Making use of this function can set the current time for the TV.

- 1 Press **MENU** to display the menu main page.
- 2 Press **◀** or **▶** repeatedly to select **ADVANCE** menu, and Press **▼** to access. Then the [**CLOCK**] item will be highlighted automatically.
- 3 Use **0-9 number** buttons to input the current time.
- 4 Press **OK** button to exit the menu or press **MENU** button to return to the Previous menu.

Note: Before setting the **ON TIMER** and **OFF TIMER**, please set the **CLOCK** item first.

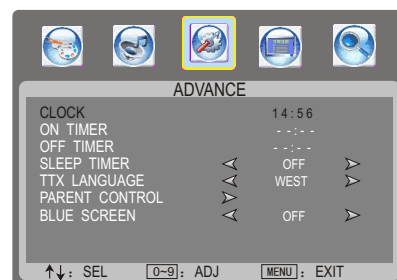

Note: The above menu is shown as an example. The menu items may be different when the unit works in different mode.

Setting ON timer

With the ON timer, the TV will automatically turn on at a preset time.

- 1 Press **MENU** to display the menu main page.
- 2 Press **◀** or **▶** repeatedly to select **ADVANCE** menu, and press **▼** to access.
- 3 Press **▲** or **▼** repeatedly to select **ON TIMER** item.
- 4 Use **0-9 number** buttons to input the time value.
- 5 Press **OK** button to exit the menu or press **MENU** button to return to the Previous menu.

Note: The TV must be in STANDBY mode for the ON TIMER to work.

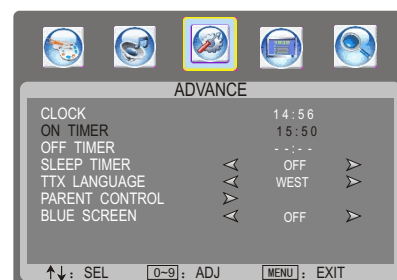

Setting OFF timer

With the OFF timer, the TV will automatically turn off at a preset time.

- 1 Press **MENU** to display the menu main page.
- 2 Press **◀** or **▶** repeatedly to select **ADVANCE** menu, and press **▼** to access.
- 3 Press **▲** or **▼** repeatedly to select **OFF TIMER** item.
- 4 Use **0-9 number** buttons to input time value.
- 5 Press **OK** button to exit the menu or press **MENU** button to return to the previous menu.

Note:

The time interval between **CLOCK** and **OFF TIMER** should be above 1 minute. When the last 1 minute comes, the unit will remind you after how many seconds the set will be turned off. During this period if you do not want the unit to be turned off, press any button to exit. If the TV loses power, the clock and timer settings will be cleared and must be reset.

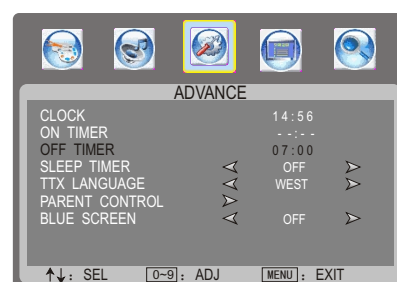

POWER DOWN:

21

Setting Advance (continued)

Setting Sleep Timer

Making use of this function allows you to have the set automatically turn off at a preset time.

- 1 Press **MENU** to display the menu main page.
- 2 Press ◀ or ▶ repeatedly to select **ADVANCE** menu, and press ▼ to access.
- 3 Press ▲ or ▼ repeatedly to select **SLEEP TIMER** item.
- 4 Use ◀ or ▶ to select the amount of time; to turn off the timer, please select **OFF**.
- 5 Press **OK** button to exit the menu or press **MENU** button to return to the previous menu.

Note: You may quickly set the sleep timer by using the **SLEEP** button on the remote control.

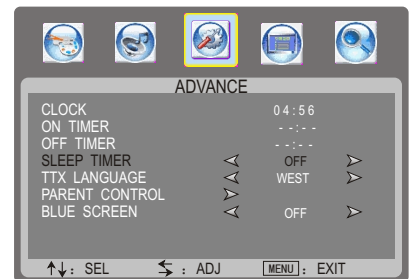

Setting Teletext Language

- 1 Press **MENU** to display the menu main page.
- 2 Press ◀ or ▶ repeatedly to select **ADVANCE** menu, and press ▼ to access.
- 3 Press ▲ or ▼ repeatedly to highlight **TTX LANGUAGE** item.
- 4 Press ◀ or ▶ repeatedly to select a desired language.
- 5 Press **OK** button to exit the menu or press **MENU** button to return to the previous menu.

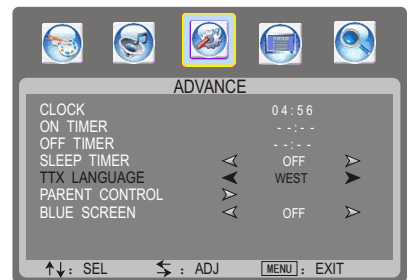

Setting Blue Screen

- 1 Press **MENU** to display the menu main page.
- 2 Press ◀ or ▶ repeatedly to select **ADVANCE** menu, and press ▼ to access.
- 3 Press ▲ or ▼ repeatedly to highlight **BLUE SCREEN** item.
- 4 Press ◀ or ▶ to select **ON** or **OFF**.

Note: When there is no signal input, a blue background appears if you set this item to **ON**.
If there is no signal input for a certain time, the TV set goes to **STANDBY** mode automatically.
This item will not active in **VGA** mode.

Note:

In **AV/S-Video** mode, there will be **COLOR SYSTEM** item instead of **BLUE SCREEN** in the **ADVANCE** menu.
If abnormal color occurs, you may try to adjust the color system in the **ADVANCE** menu.

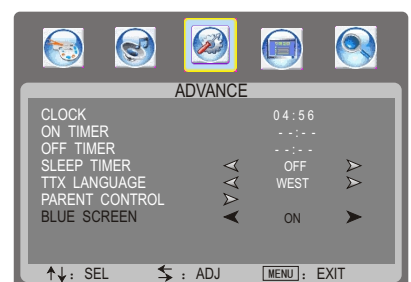

Parental Control

The Parental Control function enables parents to prevent their children from watching inappropriate programs on TV. To use Parental Control function, you first need to set your password.

Setting Password

- 1 Press **MENU** to display the menu main page.
- 2 Press **◀** or **▶** repeatedly to select **ADVANCE** menu, and press **▼** to access.
- 3 Use **▲** or **▼** repeatedly to select **PARENT CONTROL** item, and then press **◀** or **▶** to access. Now a password is required to input.
- 4 Use **0-9 number** buttons to input the password (four digit, the default password is "0000") to enter into the next-level menu. Then the **[CHANGE PIN]** item will be highlighted automatically.
- 5 Use **0-9 number** buttons to input the new password .
- 6 Input the new password again and then the password has been changed successfully.
- 7 Press **OK** button to exit the menu or press **MENU** button to return to the previous menu.

Note:

Be sure to write down your new password and retain it for future use. If you forget the password, the unit provides a super password as "2580" for you to access the locked channels or change password, but it can only be used for 5 times. Please **DO NOT** let the children know the super password.

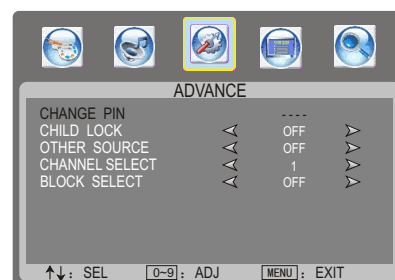
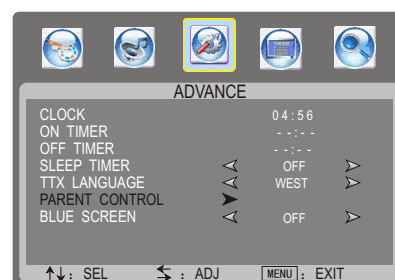

Setting Child Lock

- 1 Within the **PARENT CONTROL** submenu, press **▲** or **▼** repeatedly to highlight the **CHILD LOCK** item.
- 2 Press **◀** or **▶** to select **ON** or **OFF**.

When the **CHILD LOCK** is turned **ON**, buttons on the control panel on the main unit are not active. To restore, please set the **CHILD LOCK** to **OFF**.

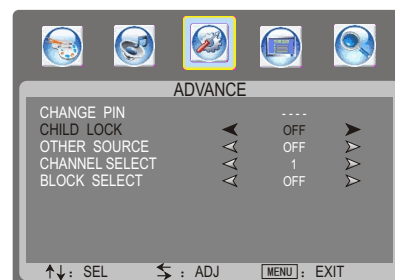

Locking or Unlocking TV Channels

- 1 Within the **PARENT CONTROL** submenu, press **▲** or **▼** repeatedly to highlight the **CHANNEL SELECT** item.
- 2 Use **◀** or **▶** to select the channel you want to block or unblock.
- 3 Press **▼** to highlight **BLOCK SELECT** item, and use **◀** or **▶** to select **ON** or **OFF**.
You can repeated the above steps to lock or unlock other channels.

Note: If there is any channel locked, you can not perform **AUTO SCAN** or **MANUAL SEARCH** unless you input the correct password.

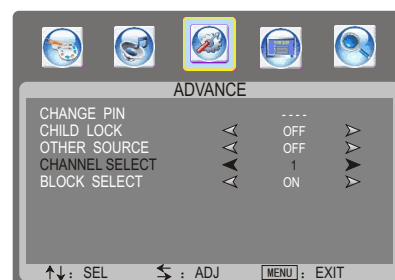

Blocking Other Source

- 1 Within the **PARENT CONTROL** submenu, press **▲** or **▼** repeatedly to highlight the **OTHER SOURCE** item.
- 2 Use **◀** or **▶** to select **ON** or **OFF**.

When you set the **OTHER SOURCE** to **ON**, the other input signal sources except TV will be blocked automatically.

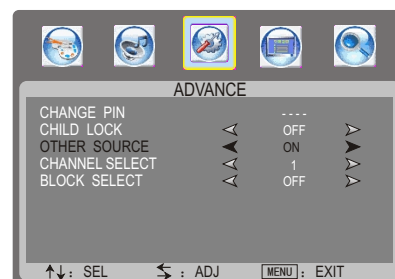

Adjusting On-Screen Display

Adjusting OSD Position

- 1 Press **MENU** to display the menu main page.
- 2 Press **◀** or **▶** repeatedly to select **SYSTEM** menu, and press **▼** to access.
- 3 Press **▲** or **▼** repeatedly to select **OSD H-POSITION** or **OSD V-POSITION** item.
- 4 Press **◀** or **▶** to adjust the OSD position.

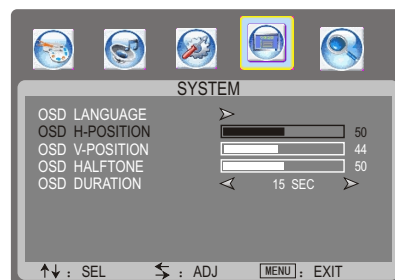

Adjusting OSD Halftone

- 1 Press **MENU** to display the menu main page.
- 2 Press **◀** or **▶** repeatedly to select **SYSTEM** menu, and press **▼** to access.
- 3 Press **▲** or **▼** repeatedly to select **OSD HALFTONE** item.
- 4 Press **◀** or **▶** to adjust the OSD halftone.

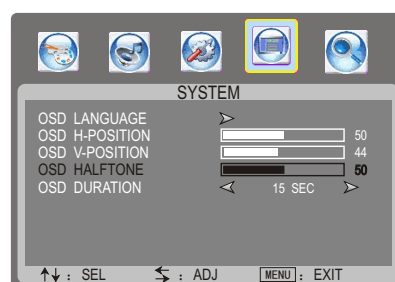

Setting OSD Timeout

This setting allows you to set the time for the main OSD menu to be displayed on screen.

- 1 Press **MENU** to display the menu main page.
- 2 Press **◀** or **▶** repeatedly to select **SYSTEM** menu, and press **▼** to access.
- 3 Press **▲** or **▼** repeatedly to highlight **OSD DURATION** item.
- 4 Press **◀** or **▶** select a proper time.

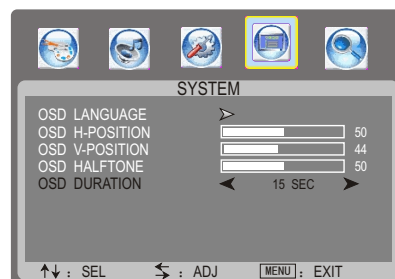

Adjustment in PC (VGA) Mode

Adjusting the Picture

- 1 Press **MENU** to display the **PICTURE** menu , and press **▼** to access.
- 2 Within the menu, use **▲** , **▼** , **◀** or **▶** to navigate or adjust.
- 3 Press **OK** button to exit the menu or press **MENU** button to return to the previous menu.

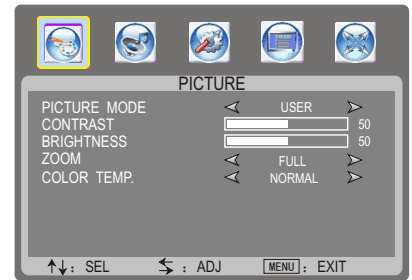

Option	Function	Choice/Remarks
Picture Mode	Selects picture mode.	Standard/Night/Outside/User Note: you may directly press P.Mode button on the remote control to select.
Contrast	Adjusts image contrast.	▶ : stronger ◀ : weaker
Brightness	Adjusts screen brightness for easier viewing of dark picture such as night scenes and black hair.	▶ : lighter ◀ : darker
Zoom	Select screen aspect ratio	Normal/Full Note: you may directly press Zoom button on the remote control to select.
Color Temperature	Selects one of three automatic color adjustments. Set to warm to enhance hotter colors such as red, or set to cool to see less intense colors with more blue.	Cool/Warm/Normal

Adjusting Image Geometry

- 1 Press **MENU** to display the menu main page.
- 2 Press **◀** or **▶** repeatedly to select **GEOMETRY** menu, and press **▼** to access.
- 3 Within the menu, use **▲** , **▼** , **◀** or **▶** to navigate or adjust.
- 4 Press **OK** button to exit the menu or press **MENU** button to return to the previous menu.

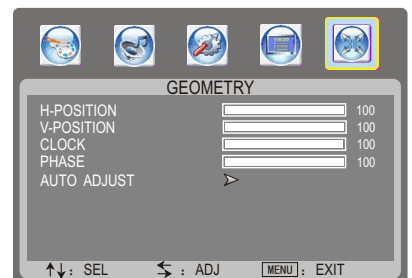

(Geometry menu in VGA mode)

Option	Function	Choice/Remarks
H-Position	Adjust the horizontal position of the image.	▶ : rightward ◀ : leftward
V-Position	Adjust the vertical position of the image.	▶ : upward ◀ : downward
Clock	Adjusts the sample frequency.	
Phase	Improves the focus of stable image.	
Auto Adjust	Automatically adjusts settings based on the signal input. Note: You may directly press Auto button on the remote control to adjust .	

Teletext

What Is Teletext?

Your System receives Teletext signals broadcast by a TV network, and decodes them into graphical format for viewing. News, weather and sports information, stock exchange prices and programme previews are among the many services available.

Teletext Mode

Teletext is turned on/off with the **Teletext** button on the remote control unit. You can operate your System in Teletext mode directly by inputting commands with the remote control unit.

Turning On or Off Teletext

Select a TV channel providing the Teletext program.
Press the **Teletext** button to display the Teletext.
Press the **Teletext** button again to switch back to TV screen.

Button Functions

▲ or ▼
Changing Teletext pages

Colour (RED/GREEN/YELLOW/BLUE)

You can select a group or block of pages displayed in the coloured brackets at the bottom of the screen by pressing the corresponding colour (RED/GREEN/ YELLOW/ BLUE) on the remote control unit.

0-9
Directly select any page by using 0-9.

Mix
Press this button to display the Teletext on the screen with transparent background while viewing the TV program simultaneously.

Reveal
Press the button to reveal hidden information such as an answer to a quiz. Press the button again to hide the information.

Size
Press the button to expand the top half of the display. Press it again to expand the bottom half of the display. Press it once more to resume normal size.

Hold
Press the button to stop updating Teletext pages automatically. Press it again to release hold mode.

Index
Press the button to view the main index page.

Note: If any abnormal characters appear when you are viewing the teletext broadcast, please try to adjust the Teletext Language in the ADVANCE menu.

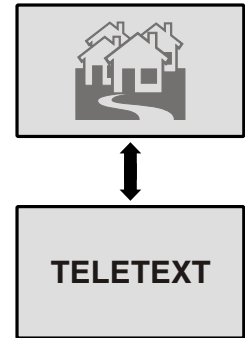

Troubleshooting

Before calling for repair service, check the following items for possible remedies to an encountered symptom.

Symptoms	Check item
"Ghost" or double images	<ul style="list-style-type: none"> • This may be caused by obstruction to the antenna due to high rise buildings or hills. Using a highly directional antenna may improve the picture.
No power	<ul style="list-style-type: none"> • Check that the AC power cord is plugged into the mains socket. • Unplug the power cord, wait for 60 seconds. Then re-insert plug into the mains socket and turn on the unit again.
No picture	<ul style="list-style-type: none"> • Check antenna connections at the rear of the unit to see if it is properly connected to the unit. • Possible broadcast station trouble. Try another channel. • Adjust the contrast and brightness settings. • Select a correct input. • Is a non-compatible signal being input?
Good picture but no sound	<ul style="list-style-type: none"> • Increase the VOLUME. • Check that the unit is not muted.
Good sound but poor colour	<ul style="list-style-type: none"> • Adjust the contrast, colour and brightness settings.
Poor picture	<ul style="list-style-type: none"> • Sometimes, poor picture quality occurs when having activated an S-VHS camera or camcorder connected and having connected another peripheral at the same time. In this case, switch off one of the other peripherals. • Check whether the room is too bright
Horizontal dotted line	<ul style="list-style-type: none"> • This may be caused by electrical interference (e.g. hairdryer, nearby neon lights, etc.) • Turn off the equipment.
Television not responding to remote control	<ul style="list-style-type: none"> • Check whether the batteries are working. Replace if necessary. • Clean the remote control sensor lens on the unit. • Do not use the remote control under strong or fluorescent lighting. • The batteries should be inserted with polarity (+, -) aligned.
Snowy picture and noise	<ul style="list-style-type: none"> • Check the antenna connection.
No stable or not synchronized VGA picture	<ul style="list-style-type: none"> • Check if you have selected the correct VGA mode in your PC.
No output from one of the speakers	<ul style="list-style-type: none"> • Adjust Balance in the SOUND menu.
Control buttons do not work	<ul style="list-style-type: none"> • Unplug the power cord, wait for some seconds. Then re-plug the power cord and turn on the unit again.

Do not use in hot and cold rooms (locations)

- When the unit is used in rooms (locations) with low temperature, the picture may leave trails or appear slightly delayed. This is not a malfunction, and the unit will recover when the temperature returns to normal.
- Do not leave the unit in a hot or cold location. Also, do not leave the unit in a location exposed to direct sunlight or near a heater, as this may cause the cabinet to deform and the LCD panel to malfunction.
(Storage temperature: 0°C to +50°C Working temperature: 5°C to +40°C)

Note:

*If your problem is not solved, restart your TV by turning it off and then on again once.
Never attempt to repair a defective TV yourself.*

Care and Maintenance

LCD Display panel information

Important Information Regarding Use of Video Games, Computers, Captions or Other Fixed Image Displays.

The extended use of fixed image program material can cause a permanent "shadow image" on the LCD panel.

This background image is viewable on normal programs in the form of a stationary fixed image. This type of irreversible LCD panel deterioration can be limited by observing the following steps:

- A. Reduce the brightness/contrast setting to a minimum viewing level.
- B. Do not display the fixed image for extended periods of time.
- C. Turn the power off when not in actual use.

Note:

The marking or retained image on the LCD panel resulting from fixed image use is not an operating defect and as such is not covered by Warranty. This product is not designed to display fixed image patterns for extended periods of time.

Cleaning and Maintenance

To clean this unit, wipe with a soft, dry cloth.

If the surfaces are extremely dirty, use a soft cloth dipped in a soap and water solution or a weak detergent solution.

- Use eyeglass cleaner to remove stubborn dirt from the LCD.
- Never use alcohol, paint thinner or benzine to clean this unit.
- Before using a chemically treated cloth, read the instructions that came with the cloth carefully.

Specification

Type:	LCD TV
Display Size diagonal:	32"
Power Supply:	AC 100-240V,50/60Hz
Power Consumption:	150W
Dimensions(mm):	814 (W) X 650 (H) X 260 (D)
Unit Weight(kg):	20

TV system & channel coverage:

System	VHF	UHF	CATV
PAL-D/K	1-12	13-57	Z1~Z37
PAL-B/G	2-12	21-69	X~Z+2, S1~S41
PAL-I	2-12	21-69	
SECAM-B/G	2-12	21-69	X~Z+2, S1~S41
SECAM-D/K	1-12	21-69	
SECAM-L'	2-4		
SECAM-L	5-12	21-69	X~Z C57, S1~S41

TV system: PAL/SECAM, BG/DK, PAL-I, SECAM-L, SECAM-L', NTSC(AV)

 Design and specifications are subject to change without notice.



SANYO Electric Co., Ltd.

5944029070
Ver. 1.0

Free Manuals Download Website

<http://myh66.com>

<http://usermanuals.us>

<http://www.somanuals.com>

<http://www.4manuals.cc>

<http://www.manual-lib.com>

<http://www.404manual.com>

<http://www.luxmanual.com>

<http://aubethermostatmanual.com>

Golf course search by state

<http://golfingnear.com>

Email search by domain

<http://emailbydomain.com>

Auto manuals search

<http://auto.somanuals.com>

TV manuals search

<http://tv.somanuals.com>