

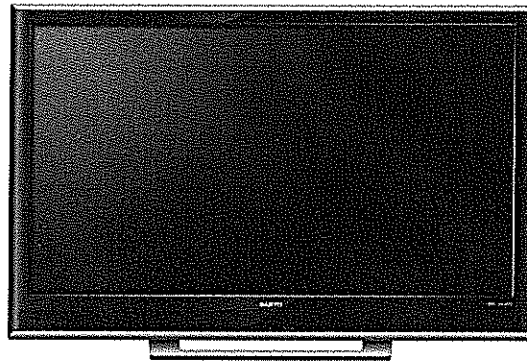

LCD TV

MODEL LCD-42S10-HD

LCD-47S10-HD



Owner's Manual

TO THE OWNER

Before operating this LCD TV, read this manual thoroughly and operate the LCD TV properly. This LCD TV provides many convenient features and functions. Operating the LCD TV properly enables you to manage those features and maintains it in better condition for a considerable time. Improper operation may result in not only shortening the product-life, but also malfunctions, fire hazard, or other accidents.

If your LCD TV seems to operate improperly, read this manual again, check operations and cable connections and try the solutions in the "Troubleshooting" section on page 40 of this booklet. If the problem still persists, contact the dealer where you purchased the LCD TV or the service center.



Safety Precaution

WARNING : TO REDUCE THE RISK OF FIRE OR ELECTRIC SHOCK, DO NOT EXPOSE THIS APPLIANCE TO RAIN OR MOISTURE.

- Install the LCD TV in a proper position. If not, it may result in a fire hazard.
- Provide appropriate space on the top, sides and rear of the LCD TV cabinet for allowing air circulation and cooling the LCD TV. Minimum clearance must be maintained. If the LCD TV is to be built into a compartment or similarly enclosed, the minimum distances must be maintained. Do not cover the ventilation slot on the LCD TV. Heat build-up can reduce the service life of your LCD TV, and can also be dangerous.
- If the LCD TV is not to be used for an extended time, unplug the LCD TV from the power outlet.

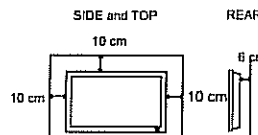

READ AND KEEP THIS OWNER'S MANUAL FOR LATER USE.

Caution In Installing

- Handle the LCD TV carefully when installing it and do not drop.
- Locate set away from heat, excessive dust, and direct sunlight.
- For correct installation and mounting it is strongly recommended to use a trained, authorized dealer. Failure to follow correct mounting procedures could result in damage to the equipment or injury to the installer.

NOTE :

When LCD TV is not used for a long period of time, unlighted dots may be observed. This is caused by characteristic of the LCD TV. If this occurs, turn the LCD TV on and leave it on about 1 hour. These dots will gradually disappear.

	CAUTION RISK OF ELECTRIC SHOCK DO NOT OPEN	
CAUTION : TO REDUCE THE RISK OF ELECTRIC SHOCK, DO NOT REMOVE COVER (OR BACK). NO USER-SERVICEABLE PARTS INSIDE. REFER SERVICING TO QUALIFIED SERVICE PERSONNEL.		
	THIS SYMBOL INDICATES THAT DANGEROUS VOLTAGE CONSTITUTING A RISK OF ELECTRIC SHOCK IS PRESENT WITHIN THIS UNIT.	
		THIS SYMBOL INDICATES THAT THERE ARE IMPORTANT OPERATING AND MAINTENANCE INSTRUCTIONS IN THE OWNER'S MANUAL WITH THIS UNIT.



SAFETY INSTRUCTIONS

All the safety and operating instructions should be read before the product is operated.

Read all of the instructions given here and retain them for later use. Unplug this LCD TV from AC power supply before cleaning. Do not use liquid or aerosol cleaners. Use a damp cloth for cleaning.

Follow all warnings and instructions marked on the LCD TV.

For added protection to the LCD TV during a lightning storm, or when it is left unattended and unused for long periods of time, unplug it from the wall outlet. This will prevent damage due to lightning and power line surges.

Do not expose this unit to rain or use near water... for example, in a wet basement, near a swimming pool, etc...

Do not use attachments not recommended by the manufacturer as they may cause hazards.

Do not place this LCD TV on an unstable cart, stand, or table. The LCD TV may fall, causing serious injury to a child or adult, and serious damage to the LCD TV. Use only with a cart or stand recommended by the manufacturer, or sold with the LCD TV. Wall or shelf mounting should follow the manufacturer's instructions, and should use a mounting kit approved by the manufacturers.

An appliance and cart combination should be moved with care. Quick stops, excessive force, and uneven surfaces may cause the appliance and cart combination to overturn.

Slots and openings in the back and bottom of the cabinet are provided for ventilation, to insure reliable operation of the equipment and to protect it from overheating.



The openings should never be covered with cloth or other materials, and the bottom opening should not be blocked by placing the LCD TV on a rug, or other similar surface. This LCD TV should never be placed near or over a radiator or heat register.

This LCD TV should not be placed in a built-in installation such as a book case unless proper ventilation is provided.

Never push objects of any kind into this LCD TV through cabinet slots as they may touch dangerous voltage points or short out parts that could result in a fire or electric shock. Never spill liquid of any kind on the LCD TV.

Do not place items such as vases containing liquid on top of the LCD TV.

Do not install the LCD TV near the ventilation duct of air-conditioning equipment.

This LCD TV should be operated only from the type of power source indicated on the marking label. If you are not sure of the type of power supplied, consult your authorized dealer or local power company.

Do not overload wall outlets and extension cords as this can result in fire or electric shock. Do not allow anything to rest on the power cord. Do not locate this LCD TV where the cord may be damaged by persons walking on it.

Do not attempt to service this LCD TV yourself as opening or removing covers may expose you to dangerous voltage or other hazards. Refer all servicing to qualified service personnel.

Unplug this LCD TV from wall outlet and refer servicing to qualified service personnel under the following conditions:

- a. When the power cord or plug is damaged or frayed.
- b. If liquid has been spilled into the LCD TV.
- c. If the LCD TV has been exposed to rain or water.
- d. If the LCD TV does not operate normally by following the operating instructions. Adjust only those controls that are covered by the operating instructions as improper adjustment of other controls may result in damage and will often require extensive work by a qualified technician to restore the LCD TV to normal operation.
- e. If the LCD TV has been dropped or the cabinet has been damaged.
- f. When the LCD TV exhibits a distinct change in performance-this indicates a need for service.

When replacement parts are required, be sure the service technician has used replacement parts specified by the manufacturer that have the same characteristics as the original part. Unauthorized substitutions may result in fire, electric shock, or injury to persons.

Upon completion of any service or repairs to this LCD TV, ask the service technician to perform routine safety checks to determine that the LCD TV is in safe operating condition.

TABLE

<p>FEATURE AND DESIGN5</p> <p>PREPARATION.....6</p> <p style="padding-left: 20px;">PART NAMES AND FUNCTIONS 6</p> <p>CONNECTING LCD TV.....8</p> <p style="padding-left: 20px;">CONNECTING THE AC POWER CORD 8</p> <p style="padding-left: 20px;">CONNECTING OUTDOOR AERIAL 8</p> <p style="padding-left: 20px;">CONNECTING A COMPUTER 9</p> <p style="padding-left: 20px;">CONNECTING VIDEO EQUIPMENT 10</p> <p>BEFORE OPERATION.....11-14</p> <p style="padding-left: 20px;">OPERATION OF REMOTE CONTROL 11</p> <p style="padding-left: 20px;">OPERATION RANGE 12</p> <p style="padding-left: 20px;">REMOTE CONTROL BATTERIES</p> <p style="padding-left: 40px;">INSTALLATION 12</p> <p style="padding-left: 40px;">ON-SCREEN MENU 13</p> <p>BASIC OPERATION.....16</p> <p style="padding-left: 20px;">TURNING ON/OFF LCD TV 16</p> <p style="padding-left: 20px;">SELECTING INPUT SOURCE 16</p> <p style="padding-left: 20px;">CHANNEL SELECTION 16</p> <p style="padding-left: 20px;">CHANNEL RECALL 16</p> <p style="padding-left: 20px;">SOUND SYSTEM 17</p> <p style="padding-left: 20px;">COLOUR SYSTEM 17</p> <p style="padding-left: 20px;">DISPLAY 17</p> <p style="padding-left: 20px;">VOLUME CONTROL 17</p> <p style="padding-left: 20px;">ECO 17</p> <p style="padding-left: 20px;">WOOFER 17</p> <p style="padding-left: 20px;">WOW HD 18</p> <p style="padding-left: 20px;">VIDEO MODE 18</p> <p style="padding-left: 20px;">AUDIO MODE 18</p> <p style="padding-left: 20px;">STILL 18</p> <p style="padding-left: 20px;">STEREO/MONO 18</p> <p style="padding-left: 20px;">WIDE 19</p> <p style="padding-left: 20px;">SPORTS 19</p> <p style="padding-left: 20px;">OFF TIMER 20</p> <p style="padding-left: 20px;">PIP OPERATION 20</p> <p style="padding-left: 20px;">USB 21</p> <p style="padding-left: 20px;">OPERATION OF REMOTE CONTROL (IN TEXT MODE) 25</p> <p style="padding-left: 20px;">TEXT TV 26</p> <p style="padding-left: 20px;">TEXT REVEAL 26</p> <p style="padding-left: 20px;">TEXT CANCEL 26</p> <p style="padding-left: 20px;">TEXT INDEX 26</p> <p style="padding-left: 20px;">TEXT SUBCODE 26</p> <p style="padding-left: 20px;">TEXT SIZE 27</p> <p style="padding-left: 20px;">TEXT HOLD 27</p>	<p style="padding-left: 20px;">TEXT RED 27</p> <p style="padding-left: 20px;">TEXT GREEN 27</p> <p style="padding-left: 20px;">TEXT YELLOW 27</p> <p style="padding-left: 20px;">TEXT BLUE 27</p> <p>MENU OPERATION (TV/AV MODE).....28</p> <p style="padding-left: 20px;">CHANNEL 28</p> <p style="padding-left: 20px;">PICTURE 30</p> <p style="padding-left: 20px;">SOUND 31</p> <p style="padding-left: 20px;">TIMER 32</p> <p style="padding-left: 20px;">OSD 33</p> <p style="padding-left: 20px;">SYSTEM 34</p> <p>MENU OPERATION (PC/HDMI MODE).....35</p> <p style="padding-left: 20px;">PICTURE 35</p> <p style="padding-left: 20px;">SOUND 36</p> <p style="padding-left: 20px;">TIMER 36</p> <p style="padding-left: 20px;">OSD 36</p> <p style="padding-left: 20px;">SYSTEM 37</p> <p style="padding-left: 20px;">DEALER MODE 38</p> <p>APPENDIX.....39</p> <p style="padding-left: 20px;">CLEANING LCD TV 39</p> <p style="padding-left: 20px;">FUNCTION OF PRODUCT SAFETY FEATURE 39</p> <p style="padding-left: 20px;">TROUBLE SHOOTING 40</p> <p style="padding-left: 20px;">TECHNICAL SPECIFICATIONS 41</p> <p style="padding-left: 20px;">CONFIGURATION OF VGA TERMINAL 42</p> <p style="padding-left: 20px;">MAC ADAPTER 42</p> <p style="padding-left: 20px;">SIGNAL MODE COLUMN 42</p> <p style="padding-left: 20px;">TABLE OF TOXIC ELEMENT FOR PRODUCTION 43</p> <p style="padding-left: 20px;">UNINSTALLING STAND BASE 44</p> <p>SRS is registered trademarks of SRS Labs, Inc.</p> <p>WOW HD is registered trademarks of SRS Labs, Inc.</p> <p>HDMI is registered trademarks of HDMI Licensing, LLC.</p> <p>TRADEMARKS</p> <ul style="list-style-type: none"> ● Apple, Macintosh, and PowerBook are trademarks or registered trademarks of Apple Computer, Inc. ● IBM and PS/2 are trademarks or registered trademarks of International Business Machines, Inc. ● Each name of corporations or products in the owner's manual is a trademark or a registered trademark of its respective corporation.
--	---

Feature and Design

◆ Picture

- **Full High Definition LCD Panel**
1920 x 1080 pixel Full HD LCD Panel makes perfect reproduction of 1080p/1080i HD contents in pixel-to-pixel.
This LCD panel also provide high contrast ratio and wide viewing angle.
- **VIZON Engine**
VIZON Engine, SANYO High Quality Image Processing Technology reproduces clear, dynamic, natural and realistic picture along with HD LCD Panel Technology.
- **Dynamic AI**
The AI (Automatic Image Control) circuit compensates picture contrast and brightness level dynamically and reproduces bright and high-contrast picture. (see page 34)

◆ Sound

- **SRS WOW HD**
SRS WOW HD creates 3D dynamic sound for impressive experience by integrated sound enhancer, SRS 3D, SRS TruBass, SRS FOCUS, Definition and Center Control. (see page 18)
- **NICAM/A2 Stereo**
It's the Stereo Sound PAL Color TV Broadcasting System upgrading mono-sound TV service to stereo or dual-language sound. (see page 18)
- **Super Woofer**
Super Woofer providing powerful sound makes viewing experience richer and more exciting. (see page 17)

◆ Feature

- **Sport Mode**
Just by pressing the button, sport mode optimizes picture and audio settings suitable for each sport program. (see page 19)
 - **Colorful World**
Dynamic picture and sound performance setting (default setting).
 - **Green Field**
Suitable setting for Football, Golf program etc.
 - **Snow World**
Suitable setting for Skiing, Ice Skating program etc.
 - **Water World**
Suitable setting for Swimming, Diving program etc.
 - **Indoor Sport**
Suitable setting for Basketball, Boxing program etc.

◆ Feature

- **Auto ECO**
Ambient light sensor automatically adjusts picture brightness to provide more relaxing view for your eyes. (see page 17)
- **USB Viewer**
USB Storage Devices are connectable to play audio (MP3, WMA), picture (JPEG, BMP, GIF, TIFF), movie (WMV, MPEG2, MPEG4, AVI), TXT. (see page 21-24)
- **PIP (1 tuner)**
Picture in Picture displays two separate source (e.g., PC and Video) at the same time. (see page 20)

◆ Compatibility

- **Full Multy System**
PAL, SECAM, NTSC, NTSC 4.43 system can be connected. (see page 17)
- **HD-Ready**
1080p, 1080i, 720, High Definition signals are receivable.
- **HDMI**
HDMI provides complete transmission of digital image and sound signals without any quality deterioration.
DVI can be connected to HDMI. (see page 9)
- **PC input**
Personal Computer/Laptop can be connected with automatic resolution adjustment.
- **Terminals**
HDMI for BluRay Player etc.
D-SUB 15-pin for PC Input etc.
Component Video for DVD
S-Video/Video for VCR/DVD

◆ Others

- **Wall Mounting**
It's designed for VESA Standard wall hanging bracket.
- **Light Commercial Mode**
By entering Dealer mode, Volume Lock, Sarr Mode, OSD, RC, Reset, AC Power Mode can be selected.
Convenient for placing in Hotel, Hospital, School, Store, Bank etc. (see page 38)

PREPARATION

PART NAMES AND FUNCTIONS

FRONT

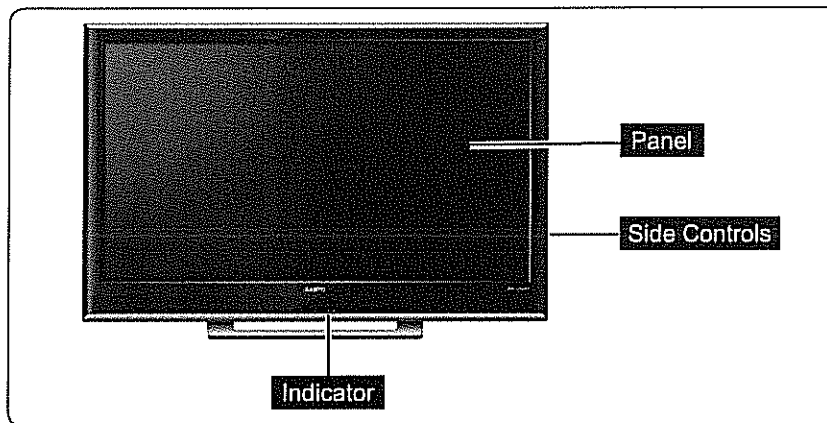

INDICATORS

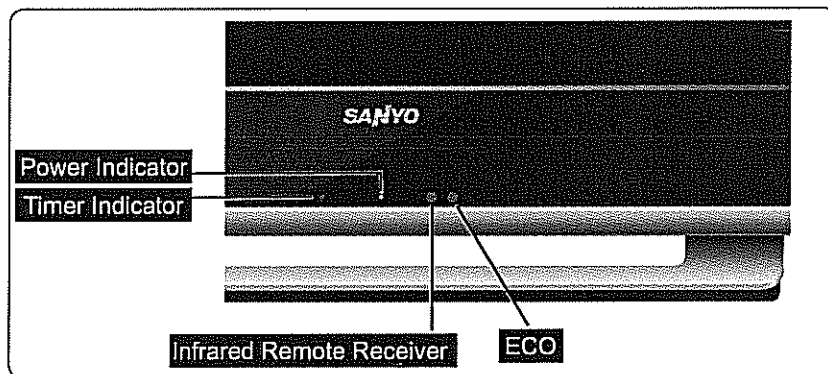

CARE FOR USING LCD TV

- Do not bump or scratch the panel surface as this causes flaws on the surface of the screen.
- There may be some tiny black points and/or blight points on the SCREEN. These points are normal.

PREPARATION

SIDE CONTROLS (Each button on the control panel has the same function with its counterpart on the remote control.)

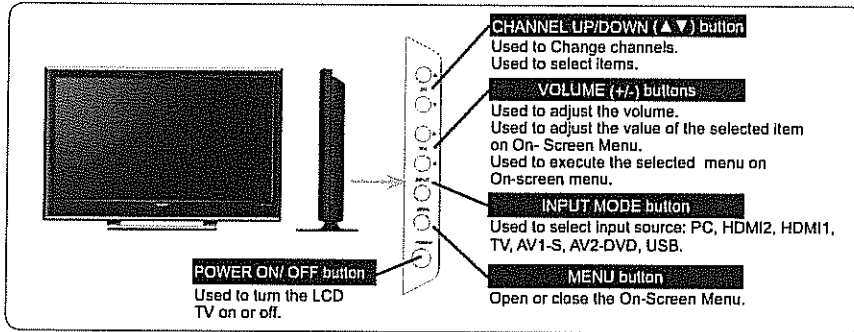

SIDE TERMINALS

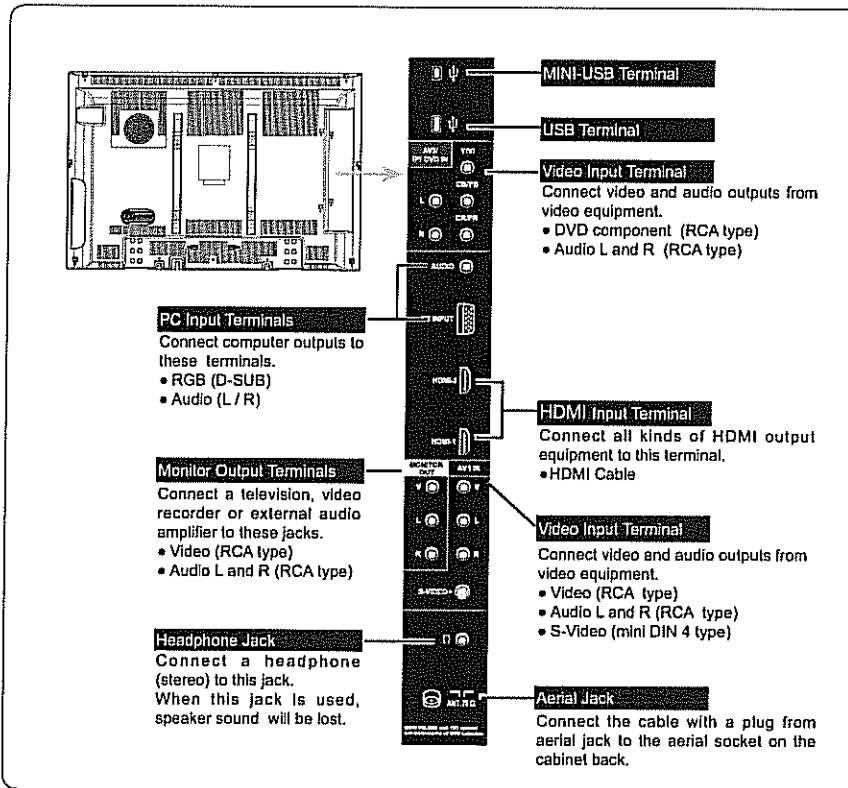

CONNECTING LCD TV

CONNECTING THE AC POWER CORD

This LCD TV uses nominal input voltages of 110-242V AC. This LCD TV automatically selects the correct input voltage. It is designed to work with single-phase power systems. To reduce risk of electrical shock, do not plug into any other type of power system. Consult your authorized dealer or service station if you are not sure of the type of power being supplied. Connect the LCD TV with all peripheral equipment before turning the LCD TV on.

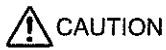

CAUTION

For safety, unplug AC power cord when the LCD TV is not in use.

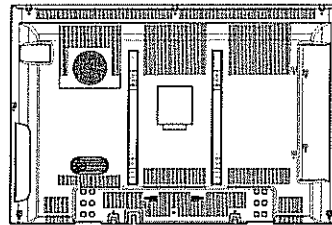

AC POWER CORD



To the AC Outlet (110 - 242V AC)
Pulls the AC power cord out from the LCD TV. The AC outlet must be near this equipment and must be easily accessible.

CONNECTING OUTDOOR AERIAL

Cable used for connection (This cable is not supplied with this LCD TV.)

- Aerial Cable

NOTE:
For all aerial circuit problems please consult your local dealer.

Outdoor Aerial

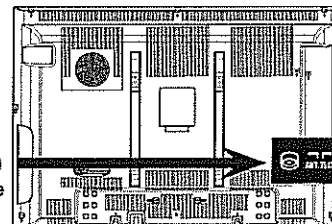
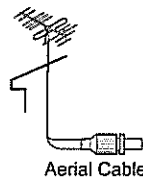

CONNECTING LCD TV

CONNECTING A COMPUTER

Cable used for connection (This cable is not supplied with this LCD TV.)

- PC/VGA Cable (D-SUB 15pin)
- HDMI Cable
- MAC Adapter (in the case of connecting Macintosh computer)
- Audio Cable [Mini Plug (L/R)]



NOTE:
When connecting the cable, AC Power Cords of both LCD TV and external equipment should be disconnected from AC outlet. Turn LCD TV and peripheral equipment on before your computer is switched on.

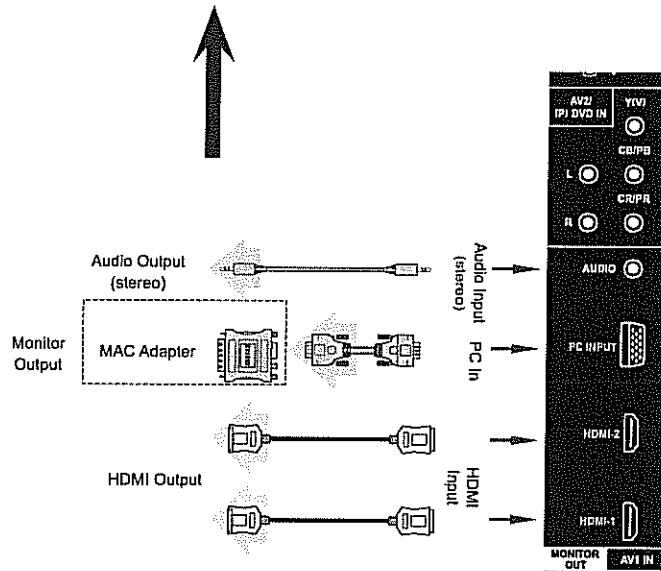
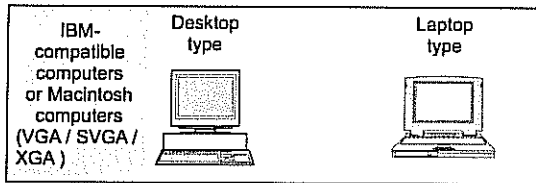

NOTE : You can connect the DVI source to HDMI input terminal by using the DVI to HDMI converter, and you just can watch image, but without sound.

CONNECTING LCD TV

CONNECTING VIDEO EQUIPMENT

Cables used for connection (These cables are not supplied with this LCD TV.)

- Video Cable(RCA X1), S-Video Cable, Audio Cable (RCA X2) : Video 1 or Video 2
- Video Cable(RCA X3), Audio Cable (RCA X2) : DVD (Component Video)
- Video Cable(RCA X1), Audio Cable (RCA X2) : Monitor Outputs
- HDMI Cable: HDMI Input



NOTE : When connecting the cable, AC Power Cords of both LCD TV and external equipment should be disconnected from AC outlet.

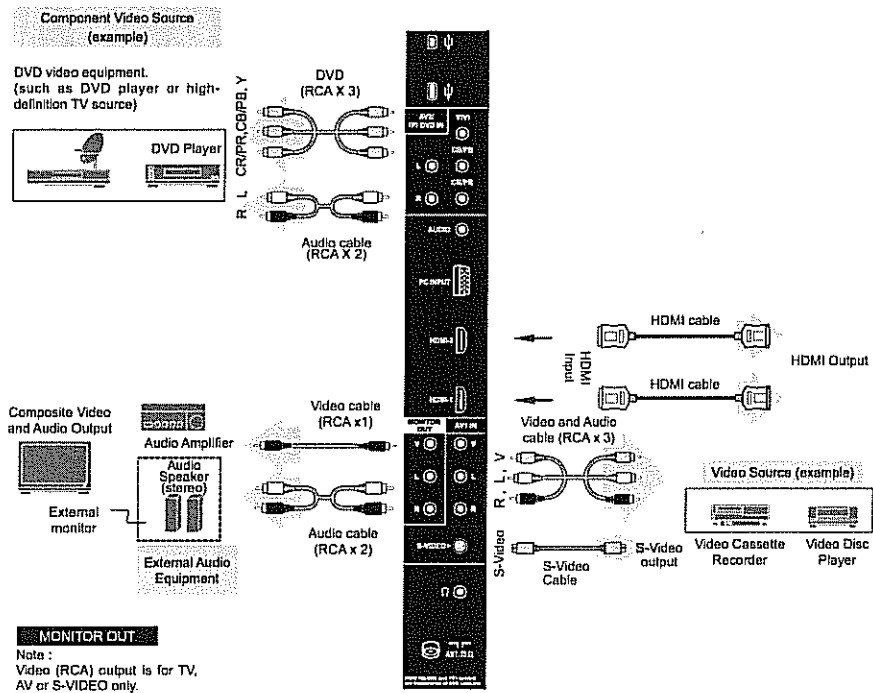

BEFORE OPERATION

OPERATION OF REMOTE CONTROL

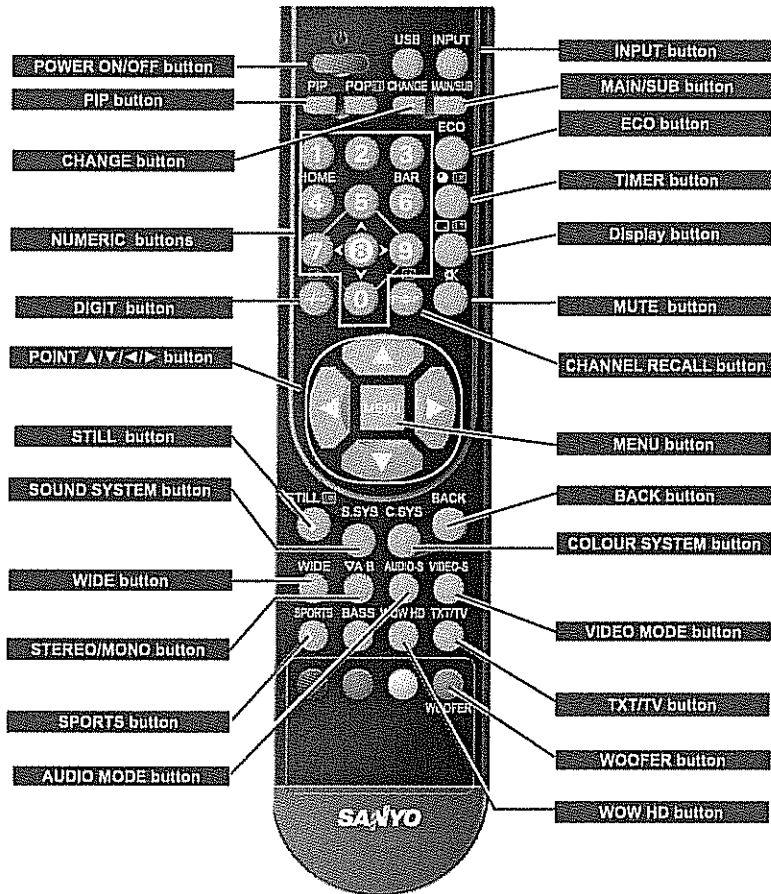

Note: 1. In different mode, some buttons have different functions. (For details, please refer to page 25.)
 2. BASS button and POP button is inactive.

BEFORE OPERATION

OPERATION RANGE

Point Remote Control toward LCD TV (Infrared Remote Receiver) whenever pressing the buttons. Maximum operating range for Remote Control is about 16.4' (5m) in front, about 30° to the left or the right, about 15° for up or down.

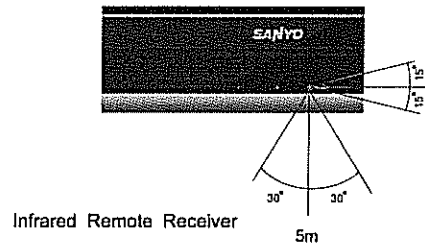

REMOTE CONTROL BATTERIES INSTALLATION

- 1 Remove the battery compartment cover .

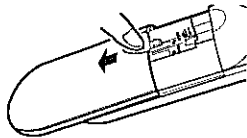

- 2 Insert two size AAA batteries (1.5V) according to "+" and "-" polarity markings inside the battery compartment.

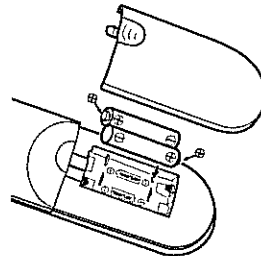

- 3 Close the battery compartment cover.

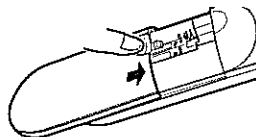

To insure safe operation, please observe the following precautions:

- Use (2) AAA, alkaline batteries.
- Replace two batteries at the same time.
- Do not use a new battery with a used battery.
- Avoid contacting with water or liquid.
- Do not expose the Remote Control to moisture, or heat.
- Do not drop the Remote Control.
- If a battery has leaked on the Remote Control, carefully wipe case clean and install new batteries.
- Risk of explosion if battery is replaced by an incorrect type.
- Dispose of used batteries according to the instructions.

BEFORE OPERATION

ON-SCREEN MENU

TV/AV MODE MENU LIST

Note: "CHANNEL" menu is only active in TV mode.

MAIN MENU (CHANNEL MENU)

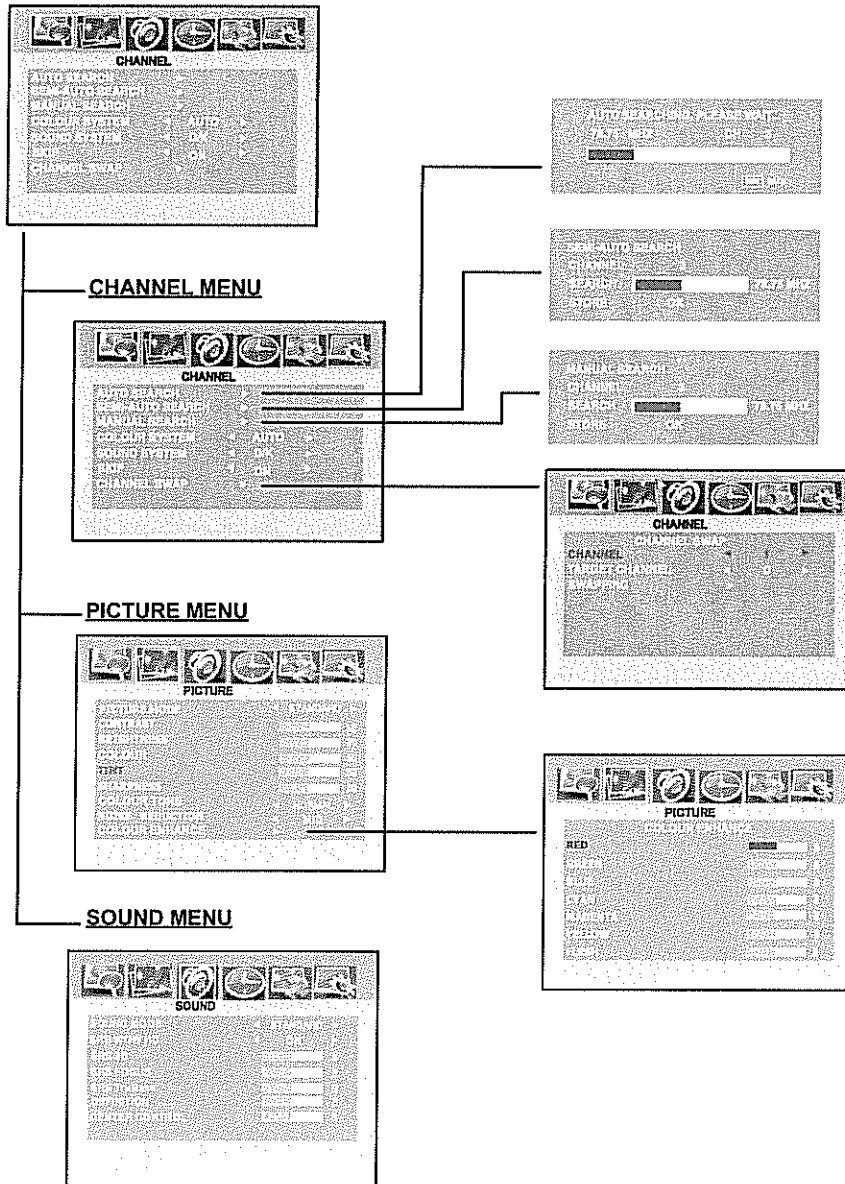

BEFORE OPERATION

ON-SCREEN MENU

PC/HDMI MODE MENU LIST

MAIN MENU (PICTURE MENU)

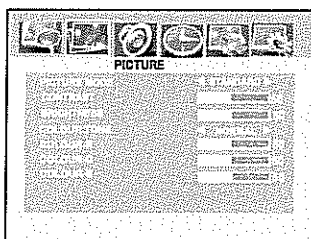

SYSTEM MENU

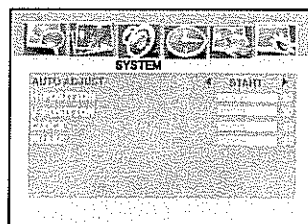
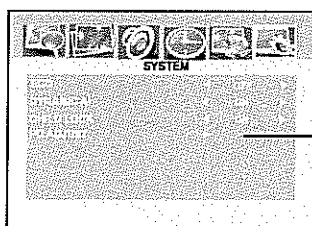

- Note:
1. "PC ADJUST" is only active in PC mode.
 2. SOUND/ TIMER/ OSD menu in PC/ HDMI mode is the same as TV/AV mode, please refer to pages 13~14.

BASIC OPERATION

TURNING ON / OFF LCD TV

- 1 Complete the peripheral connections before turning on LCD TV. (Please refer to "CONNECTING LCD TV".)
- 2 Connect LCD TV's AC Power Cord into an AC outlet.
- 3 Press POWER ON/OFF button on Side Controls of LCD TV or on Remote Control to turn it ON. The POWER indicator will light up (green). Press POWER ON/OFF button again to shift it to stand-by status, the POWER indicator will become red.

NO SIGNAL SHUT OFF

This TV set incorporates the NO SIGNAL SHUT OFF function. If no signal is input in TV mode, "OFF 00:10" will display for about 10 minutes and TV will be turned off automatically.

SELECTING INPUT SOURCE

Select mode "PC", "HDMI2", "HDMI1", "TV", "AV1-S", "AV2-DVD" or "USB" by pressing INPUT button on Remote Control or on Side Controls.



CHANNEL SELECTION

There are 256 channels can be selected on the LCD TV.

DIRECT SELECTION

For direct access to programmes using the (0-9) numeric button.

- 1) For selection of channel position 0 - 9. Example: For channel position 8, press the "8" button.
- 2) For selection of channel position 10 - 99. For channel position 25, press the DIGIT button to display "- -", then press "2" and "5" buttons.
- 3) For selection of channel position 100 - 199. For channel position 125, press the DIGIT button twice to display "1 - -", then press "2" and "5" buttons.
- 4) For selection of channel position 200 - 255. For channel position 235, press the DIGIT button three times to display "2 - -", then press "3" and "5" buttons.

CHANNEL UP/ DOWN

Press POINT ▲/ ▼ buttons on Side Controls or on Remote Controls to select programs.

- Press POINT ▲ button to select next channel.
- Press POINT ▼ button to select previous channel.

CHANNEL RECALL

Press CHANNEL RECALL button to switch between the previous channel and the current channel.

For example, now you are watching channel "4", but you watched channel "2" previously. If you press CHANNEL RECALL button, channel "2" will appear immediately.

BASIC OPERATION

SOUND SYSTEM

Press SOUND SYSTEM button repeatedly to select "D/K", "I", "M" or "B/G" until the best sound effect is reached.

COLOUR SYSTEM

Press COLOUR SYSTEM button repeatedly to select "AUTO", "PAL", "SECAM", "NTSC" or "NTSC4.43" until the best colour effect is reached.

DISPLAY

Press DISPLAY button on Remote Control to display the status of LCD TV. Press again to remove the display.

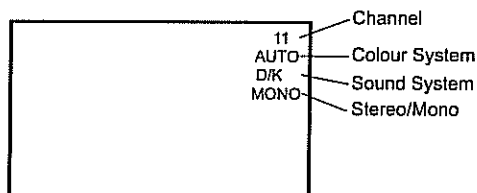

VOLUME CONTROL

To adjust the volume value desired by pressing POINT ◀ ▶ buttons on Remote Control or on Side Controls. The volume dialogue box will appear on the screen for a short while. POINT ▶ button to increase volume, and POINT ◀ button to decrease volume.



ECO

This function is used to automatically adjust panel's brightness by ambient brightness. Press ECO button on Remote Control to set "AUTO ECO", "ECO ON" or "ECO OFF".

WOOFER

Wonderful woofer has set in the TV, you can enjoy splendid woof effect in your family. Press WOOFER button on Remote Control to set "WOOFER ON" or "WOOFER OFF".

BASIC OPERATION

WOW HD

SRS WOW HD is advanced for SRS 3D, SRS FOCUS, SRS TruBass, DEFINITION and CENTER CONTROL. It is the high-tech for audio dealing researched by American SRS lab.

Press WOW HD button on Remote Control to enter into the setting WOW HD menu (Please refer to "SOUND" menu on page 31.)

VIDEO MODE

Simply press VIDEO MODE button on Remote Control to select the following video signals:

PERSONAL

User presets picture adjustment in Picture mode.

STANDARD

Natural and splendid picture level preset on this LCD TV.

DYNAMIC

Bright and dynamic picture. It is suitable for nice playback, such as DVD program.

SOFT

Inhibit strong contrast and colour, it is beneficial for eye protection.

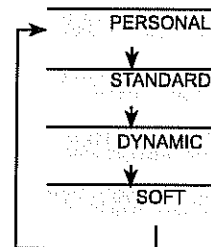

AUDIO MODE

Simply press AUDIO MODE button on Remote Control to select the following audio signals:

STANDARD

Normal sound state preset on LCD TV.

VOICE

Select this mode for talk programs.

MUSIC

Select this mode for music programs.

MOVIE

Select this mode for movie programs.

PERSONAL

Select this mode for user to call out the preset sound adjustment in SOUND menu.

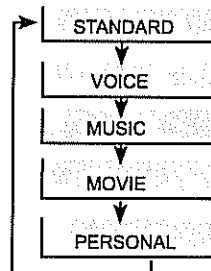

STILL

Press STILL button to switch the still function On or Off.

When in PIP mode, still function can still main picture.

To cancel "Still" function:

Press STILL button or PIP button to cancel the function, or you can switch the input source to cancel it also.

- Note:
- When the still function is On, the picture will still, but the sound will be remain.
 - The function doesn't work when the input signal is 1080p.

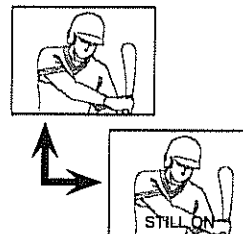

STEREO/MONO

Simply press STEREO/MONO button to select the following audio signals: "STEREO", "MONO", "NICAM", "A" and "B".

BASIC OPERATION

WIDE

Select screen size among "Full", "Zoom", "Zoom[Caption-IN]", "Normal" and "Natural Wide" by pressing WIDE button on Remote Controls.

* Only "Full" mode can be selected when the input mode is "VGA", "HDMI", "DVD" or "USB" and the input signal is 1080i, 720p or 1080p.

Full

Provides image to fit width of screen by expanding image width uniformly. This function can be used for enjoying a squeezed video signal with wide video aspect ratio of 16 : 9 screen. When your video equipment (such as DVD) has 16 : 9 output mode, select 16 : 9 and select "Full" to provide better quality.

Zoom

Provides image to fit screen size (16 : 9 aspect ratio) by expanding image width and height uniformly. This function can be used for enjoying a letter box mode picture (4 : 3 aspect picture with black bar on top and bottom edges) with wide video aspect of 16 : 9 screen.

Zoom [Caption-IN]

Provides the Image that is expanded as "Zoom" mode and moved up to show more image to include captions. This function can be used for enjoying a letter box picture with captions.

Normal

Provides real 4 : 3 image on 16 : 9 screen.

Natural Wide

Provides image to fit width of screen by expanding up/down/left/right of image. This function is suitable to enjoy a normal video signal (4 : 3 aspect ratio) with wide video aspect ratio of 16 : 9 screen.

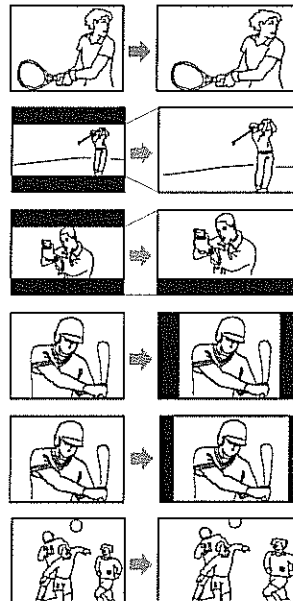
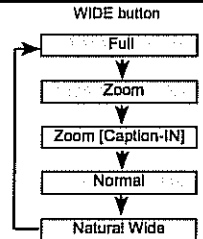

SPORTS

Select sports mode "Colorful World", "Green Field", "Snow World", "Water World" and "Indoor Sport" by pressing SPORTS button repeatedly on Remote Controls.

COLORFUL WORLD

Dynamic picture and sound performance setting (default setting).

GREEN FIELD

Use to watch football program, golf program or etc.

SNOW WORLD

Use to watch skiing program or etc.

WATER WORLD

Use to watch swimming program, diving program or etc.

INDOOR SPORT

Use to watch basketball program, badminton program or etc.

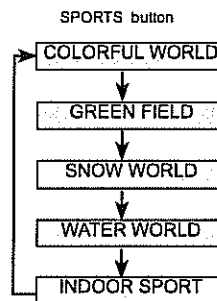

BASIC OPERATION

OFF TIMER

To set OFF TIMER by pressing TIMER button on Remote Control. The timer dialogue box will appear on the screen for a short while.

To select "0 min", "30 min", "60 min", "90 min" or "120 min" with TIMER buttons.

PIP OPERATION

Using PIP function, you can enjoy a TV program and an image such as DVD input from a rear terminal at the same time.

- 1 Press PIP button to display sub picture.
- 2 Each time PIP button is pressed, the location of sub picture is changed as follows.
- 3 During PIP mode, pressing the MAIN/SUB button will switch main and sub picture. The sound on the main picture and the sub-picture also changes at the same time.
- 4 Press CHANGE button in PIP mode can switch input source in Sub picture. (Refer to this page "PIP Combination".)
- 5 Press PIP button or POWER ON/OFF button to exit PIP mode.

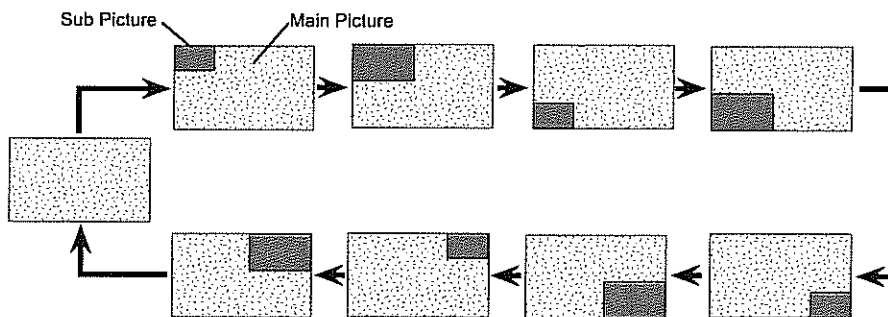

Note: The controls belongs to the picture which is TV input in PIP mode. Otherwise, it belongs to the main picture.

Combination of the Main-picture and Sub-picture

The following combination (Main and Sub picture) in the PIP mode, "✓" indicates that it is possible for combination, and "X" indicates that it is impossible for combination.

Note: DVD Input terminal should be connected so that AV2-DVD in the following table can be combined with TV or AV1-S, otherwise it cannot be combined with TV or AV1-S.

MAIN SUB	PC	HDMI 2	HDMI 1	TV	AV1-S	AV2-DVD
PC	X	✓	✓	✓	✓	✓
HDMI 2	✓	X	X	✓	✓	✓
HDMI 1	✓	X	X	✓	✓	✓
TV	✓	✓	✓	X	X	✓
AV1-S	✓	✓	✓	X	X	✓
AV2-DVD	✓	✓	✓	✓	✓	X

BASIC OPERATION

USB

After Flash disk, Mobile Hard Disk or other USB devices are inserted the USB terminal, you can read, cancel, paste or delete photo, music, movie, text or other data which are memorized in these USB devices, or you can print photo after connected printer with PictBridge Protocol.

The system has two USB terminal:

- USB terminal: use to read USB device;
- MINI-USB terminal: use to connect printer to print photo which is memorized in USB device.

⚠ Note:

- Do not pull in/out USB device frequently. If you pull out USB device when it is being played, maybe it would result physical deterioration for USB device or LCD TV.
- If USB device cannot be read, please try to pull in/out several times.
- Please switch to other modes when you find USB mode abnormally, then restart SUB mode again.
- If you want to rechange connecting way in USB mode, please disconnect the printer or PC first, or it maybe will result the machine works abnormally.

1 Function for Reuse button in USB mode

[3]	: page up	[0]	: down
[1]	: page down	[7]	: left
[4] / [HOME]	: home page	[9]	: right
[6] / [BAR]	: bar hide/recall	[8]	: confirm
[5]	: up		

- ⚠ Note:
- Channel selection by Numeric button is inactive in USB status.
 - TIMER menu cannot be selected in USB status.

2 After USB device has been inserted the USB terminal, you can press USB button to enter to the USB menu, then select Photo, Music, Movie, Text, Manager or Setup by pressing "7" or "9" button.

- ⚠ Note: If no USB device has been inserted the USB terminal, the screen will display "No USB device detected! Or USB device unavailable!"

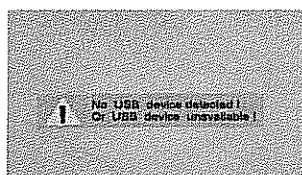
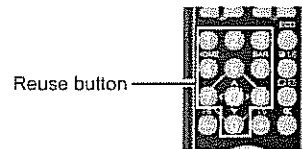

Photo

1 Press "7" or "9" button to select "Photo", and press "8" button to enter the related interface, according to the prompting to find "Photo" file, and press "8" button to enter photo file, then press "5" or "0" to select any photo and press "8" button to display.

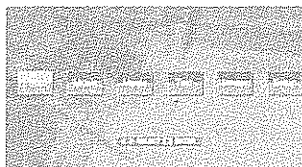

2 Press BAR button to display Information Bar in playing photo status. Press "7" and "9" button to select corresponding function on the bar, then press "8" button to operate. Press BAR button again to exit Information Bar.



BASIC OPERATION

3 Corresponding function (from left to right) on information bar

- Status
 - Play/Pause
 - Stop
 - Picture Rotation
 - Picture Amplify
 - Previous Picture
 - Picture Information display
 - Multi Display
 - Picture Print (Just supported by JPEG format)
 - Picture Resolution
 - Picture Print :
 - Press "7" or "9" button to select "Setup" in USB menu, and press "8" button to enter the corresponding interface.
 - Press "5" or "0" button to select Usb Mode and enter sub menu, then you can select "PRINTER" and connect related printer.
 - Select the picture which you want to print, then press "7" or "9" button to select the icon of Printer on the Information bar.
 - If it appears abnormal when connecting the related printer, you can try to enter USB mode again, then connect it according to the above operating way.
- ⚠ Printer with PictBridge Protocol can compatible with the LCD TV.
- Multiple Pictures display
 - Select the icon of Multiple Pictures display on the information bar.
 - Press "7", "9", "0", "5" button to select any of picture, then press "8" button to display the picture
 - Press "3" "1" button to next or previous page.

Music

1 Press "7" or "9" button to select "Music", and press "8" button to enter the related interface, according to the prompting to find "Music" file, and press "8" button to enter music file, then press "5" or "0" to select any music and press "8" button to display.



2 Press BAR button to display Information Bar in playing music status. Press "7" and "9" button to select corresponding function on the bar, then press "8" button to operate. Press BAR button again to exit Information Bar.



3 Corresponding function (from left to right) on information bar

- Status/ Playing Time
- Play/ Pause
- Stop
- Previous
- Fast Rewind
- Fast Forward
- Next
- Music file information
- Song information
- Playing mode (Standard Play/ File Repeat/ Folder Repeat)

BASIC OPERATION

Movie

- 1 Press "7" or "9" button to select "Movie", and press "8" button to enter the related interface, according to the prompting to find "Movie" file, and press "8" button to enter movie file, then press "5" or "0" to select any movie and press "8" button to display.

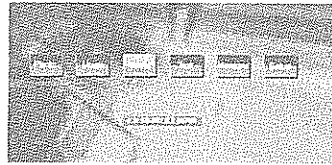

 Note: Please do not operate when large capacity of movie file is being read.

- 2 Press BAR button to display Information Bar in playing movie status. Press "7" and "9" button to select corresponding function on the bar, then press "8" button to operate. Press BAR button again to exit Information Bar.



- 3 Corresponding function (from left to right) on Information bar

- Status/ Playing Time
- Play/ Pause
- Stop
- Previous
- Fast Rewind
- Fast Forward
- Next
- Movie file information
- Amplify
- Playing mode (Audio Information/ Standard Play/ File Repeat/ Folder Repeat)

Text

- 1 Press "7" or "9" button to select "Text", and press "8" button to enter the related interface, according to the prompting to find "Text" file, and press "8" button to enter text file, then press "5" or "0" to select any text and press "8" button to display.
- 2 Press "5" or "0" button to select up or down line.
- 3 Press "7" or "9" button to select page up or down.
- 4 Press "HOME" button to return to text list.



BASIC OPERATION

Manager

- 1 Press "7" or "9" button to select "Manager", and press "8" button to enter the corresponding interface, then according to the prompting to find "Manager" file, and press "8" button to display all file list.
 - All file can be read in "Manager" folder.
- 2 Press "5" or "0" button to select any file, and press "8" button to play.
- 3 If the file includes music and photo, you can press BAR button to switch Information Bar for music or photo.

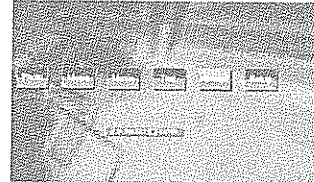

Setup

- 1 Press "7" or "9" button to select "Setup", and press "8" button to enter the related interface, then according to the prompting to find "Setup" file, and press "8" button to display setup list.
- 2 Press "5" or "0" button to select adjusted item.
- 3 Press "8" button to enter item menu.

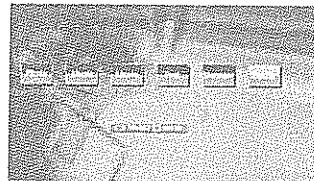

- Language: English(ANSI), Cyrillic(Windows), Arabic(Windows)
- Play Mode: Normal, Random, Bottom-Top, Top-Bottom, Left-Right, Right-Left, Topleft-Bottomright, Topright-Bottomleft, Bottomleft-Topright, Hordoor-Close, Hordoor-Open, HorInterCross, VerInterCross
- Slideshow Mode: Fast, Normal, Slow
- Multi Display: 4x3, 8x6
- Version
- Usb Mode: PRINTER, PC

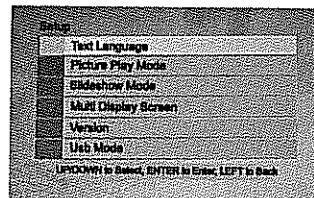

Cancel/ Paste/ Delete function

If you want to cancel, paste or delete any file, you can operate as following steps:

- 1 To enter Photo, Music, Movie, Text or Manager folder as above operation
- 2 Press "5" or "0" button to select any file in the folder, and press "9" button to confirm, it will appear the symbol as the right picture.
- 3 Press "BAR" button to display Function Bar. Press "5" or "0" button to select Cancel or Delete on Function Bar, and then press "8" to operate.

Note: Paste function must be operated on target file. If you operate the function on current file, it will display error prompting.

If want to use paste function, please operate as step 1 and step 2, then select the target file and operate as step 3 on target file.

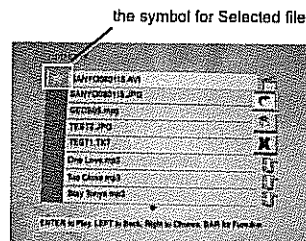

BASIC OPERATION

OPERATION OF REMOTE CONTROL (IN TEXT MODE)

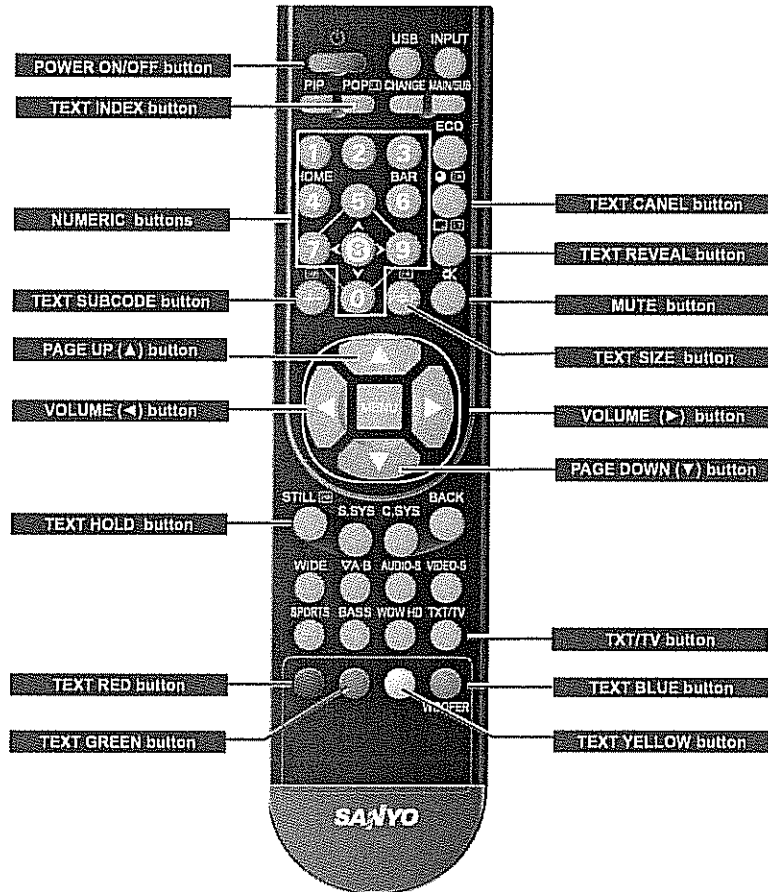

Note: In different mode, some buttons have different functions. (For details, please refer to page 11.)

BASIC OPERATION

TEXT/ TV

Press TXT/TV button to select teletext. Press again will display:

- TV mode: TV → TEXT mode → MIX mode → TV
- AV mode: AV → TEXT mode → MIX mode → AV

Note:

- TEXT mode: TEXT screen is displayed.
- MIX mode: TV/AV (broadcast image) screen and the contents of TEXT(it superimposed) are displayed simultaneously.
- CANCEL mode: TEXT/MIX MODE is canceled temporarily and broadcast image is displayed. However, the available key are the same as TEXT mode.
- In the following state, the TXT/TV button is invalid.
 - RF non-signal (Auto shut off)
 - AV non-signal (Blue back)
- The TXT/TV button is pressed during the CANCEL mode. The CANCEL mode will be canceled, and it will become a TEXT screen.

TEXT REVEAL

- Press REVEAL button to reveal hidden items on the text page.
- Some pages such as quiz pages have the answers hidden. The button may have to be held to keep the answer on the screen, or press again to remove the answer.
- In REVEAL OFF, this indication is not given.
- REVEAL button does not work except a text function. (The recall button usually operates.)

TEXT CANCEL

- When press the TEXT CANCEL button in TEXT or MIX mode, the TV picture appears on the screen.
- CANCEL mode will be canceled if the button pressed once again.
CANCEL mode is also canceled by the TXT/TV button.
- In CANCEL mode, "CAN" is always displayed on the screen upper left.

TEXT INDEX

Press the INDEX button to select the teletext index page in TEXT, MIX, CANCEL mode.

TEXT SUBCODE

1. Press TEXT SUBCODE button, "110/. . ." will be displayed (e.g. the current page is 110).
2. Press the NUMERIC buttons(0-9) to enter the sub page. For example, to select sub page 4, press NUMERIC buttons 0-0-0-4, and "110/0004" will be displayed.

BASIC OPERATION

TEXT SIZE

Press TEXT SIZE button to enlarge the top half of the text page.
Press TEXT SIZE button again to enlarge the bottom half of the text page.
Press TEXT SIZE button again to return to the normal size page.

Normal → top half enlargement → bottom half enlargement → normal

Note:

- During the top half enlargement or the bottom half enlargement mode, if a page request is performed by [0] - [9] button and the TEXT INDEX button, it will become the normal mode and a page will be requested.
- If HOLD ON / OFF is performed during the top half enlargement mode, it will still at the top half enlargement mode. (A HOLD symbol display)
- If HOLD ON / OFF is performed during the bottom half enlargement mode, it will still at the bottom half enlargement mode. (A HOLD symbol not display)

TEXT HOLD

Press TEXT HOLD button to stop page request and updating .

- HOLD ON: The symbol  will appear instead of the page number.
Update of TELETEX is forbidden. It stops on the TEXT screen display now.
- HOLD OFF: A status display will be page number display.
- TELETEX page data is updated.
 - A screen is updated by reception of the UPDATE signal.
 - A screen is eliminated by reception of an ERASE signal.
 - TEXT HOLD button does not work except a text function.

TEXT RED

The page of a red prompt is required. (also cancel mode)

TEXT GREEN

The page of a green prompt is required. (also cancel mode)
This button doesn't work except for TEXT mode .

TEXT YELLOW

The page of a yellow prompt is required. (also cancel mode)
This button doesn't work except for TEXT mode .

TEXT BLUE

The page of a blue prompt is required. (also cancel mode)

MENU OPERATION (TV/ AV mode)

CHANNEL

⚠ Note:

- The CHANNEL menu doesn't work except for TV mode.
- In PIP mode, the CHANNEL mode doesn't work except for the main picture is TV mode.

- 1 Press MENU button and the main menu will appear. Press POINT ◀ ▶ buttons to select "CHANNEL", and will display CHANNEL menu.
- 2 Press POINT ▲ ▼ buttons to select the item desired.
- 3 Press POINT ◀ ▶ buttons to adjust value.
 - Press BACK button to return to the previous menu.
 - Press MENU button or wait for 5~60 seconds (refer to "DURATION" on page 33) to exit menu operation.

AUTO SEARCH

All receivable channels are automatically tuned in and memorized in consecutive programme position.

- After all receivable channels have been found and stored, the TV set will automatically return to programme position "1".

SEMI-AUTO SEARCH

Use to preset a receivable channel in any desired programme position, e.g. the position with the same number as the channel.

- 1 Select channel "3".
- 2 Enter into "CHANNEL" menu, pressing POINT ▲ ▼ buttons to select "SEMI-AUTO SEARCH".
- 3 Press POINT ◀ ▶ to start the channel searching.
- 4 Press POINT ▶ button will move tuning toward the higher frequencies, and press POINT ◀ will move tuning toward the lower frequencies.

Press and release POINT ◀ or POINT ▶ button to search for required TV station. Once a station is located, searching will automatically stop. Continue till desired channel is located.

 - Press BACK button to return to the previous menu.
 - Press MENU button or wait for 5~60 seconds (refer to "DURATION" on page 33) to exit menu operation.

MANUAL SEARCH

Manual search a channel if it cannot be automatically tuned, such as when the signal is poor.

- 1 Select channel "3".
- 2 Enter into "CHANNEL" menu, pressing POINT ▲ ▼ buttons to select "MANUAL SEARCH".
- 3 Press POINT ◀ ▶ to start the channel searching.
- 4 Press and hold POINT ◀ or POINT ▶ button to search for required TV station.
 - Press BACK button to return to the previous menu.
 - Press MENU button or wait for 5~60 seconds (refer to "DURATION" on page 33) to exit menu operation.

SCREEN MENU

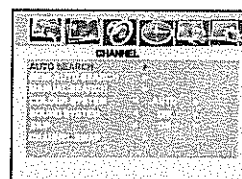
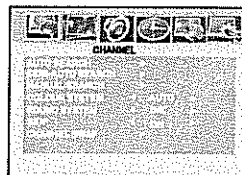

AUTO SEARCH MENU



SEMI-AUTO SEARCH MENU



MANUAL SEARCH MENU



MENU OPERATION (TV/ AV mode)

COLOUR SYSTEM

The setting for colour system is only active in TV or AV mode.

Usually, the colour system is set to the position of "AUTO". In case of abnormal colour, repeatedly press POINT ◀ ▶ buttons to select "AUTO", "PAL", "SECAM", "NTSC" or "NTSC4.43" until the best colour effect is reached.

SOUND SYSTEM

The setting for sound system is only active in TV mode.

Press POINT ◀ ▶ buttons repeatedly to select "D/K", "I", "M" or "B/G" until the best sound effect is reached.

SKIP

This feature is used to remove unwanted channels from the channel scanning memory.

You can skip the unused or undesired channels when you are selecting a channel using POINT ▲ ▼ buttons.

This function is only active in TV mode.

The settings for sound system, colour system or skip are automatically memorized in the programme position.

CHANNEL SWAP

To swap the channels between two stored programme positions.

- 1 Press MENU button to display the main menu.
 - 2 POINT ◀ ▶ buttons to select "CHANNEL", and will display CHANNEL menu. Press POINT ▲ ▼ buttons to select CHANNEL SWAP.
 - 3 Press POINT ◀ ▶ buttons to enter into the Channel Swap menu. Press POINT ▲ ▼ buttons to select the CHANNEL or TARGET CHANNEL, then Press POINT ◀ ▶ buttons to set the swap channel. And then press POINT ▲ ▼ buttons to select SWAPPING item, then press POINT ◀ ▶ buttons to select "OK".
- Press BACK button to return to the previous menu.
 - Press MENU button or wait for 5-60 seconds (refer to "DURATION" on page 33) to exit menu operation.

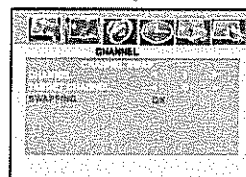
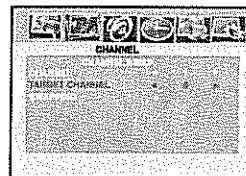
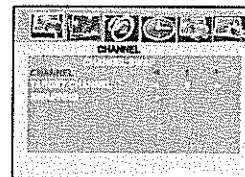
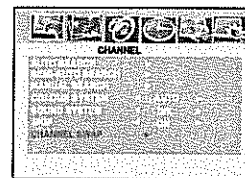

MENU OPERATION (TV/ AV mode)

PICTURE

- 1 Press MENU button and the main menu will appear. Press POINT ◀ ▶ buttons to select "PICTURE", and will display PICTURE menu.
- 2 Press POINT ▲ ▼ buttons to select the item desired.
- 3 Press POINT ◀ ▶ buttons to adjust value.
 - Press BACK button to return to the previous menu.
 - Press MENU button or wait for 5-60 seconds (refer to "DURATION" on page 33) to exit menu operation.



Note:

- TINT cannot be adjusted when HDMI input.
- TINT cannot be adjusted except in NTSC / NTSC 4.43 system.

PICTURE MODE

Select "PERSONAL", "STANDARD", "DYNAMIC" or "SOFT" by pressing POINT ◀ ▶ buttons.

- PERSONAL: User presets picture adjustment in PICTURE MODE.
- STANDARD: Natural and splendid picture level preset on LCD TV.
- DYNAMIC: Bright and dynamic picture. It is suitable for nice playback, such as DVD program.
- SOFT: Inhibit strong contrast and colour, it is beneficial for eye protection.

CONTRAST

Press POINT ◀ button to decrease contrast, and POINT ▶ button to increase contrast. (0-100)

BRIGHTNESS

Press POINT ◀ button to adjust image darken, and POINT ▶ button to adjust image brighten. (0-100)

COLOUR

Press POINT ◀ button to lighten colour, and POINT ▶ button to darken colour. (0-100)

TINT

Press POINT ◀ ▶ buttons to obtain proper colour. (0-100)

SHARPNESS

Press POINT ◀ button to soften the image, and POINT ▶ button to sharpen the image. (0-100)

COLOUR TONE

This function is used for selecting colour temperature. Select "NORMAL", "WARM" or "COOL" with POINT ◀ ▶ buttons.

NOISE REDUCTION

This function is used for reducing noise interference on the screen. Select "LOW", "MID", "HIGH" or "OFF" with POINT ◀ ▶ buttons.

COLOUR ENHANCE

This function can adjust seven kinds of colour. They are RED, GREEN, BLUE, CYAN, MAGENTA, YELLOW and FLESH. Press POINT ▶ button to lighter colour, and POINT ◀ button to darker colour. (0-15)

SCREEN MENU

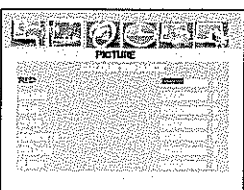
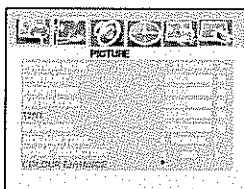
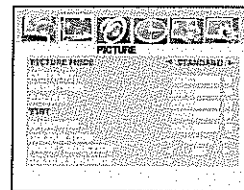
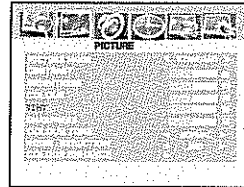

MENU OPERATION (TV/ AV mode)

SOUND

- 1 Press MENU button and the main menu will appear. Press POINT ◀ ▶ buttons to select "SOUND", and will display SOUND menu.
- 2 Press POINT ▲ ▼ buttons to select the item desired.
- 3 Press POINT ◀ ▶ buttons to adjust value.
 - Press BACK button to return to the previous menu.
 - Press MENU button or wait for 5-60 seconds (refer to "DURATION" on page 33) to exit menu operation.

SCREEN MENU

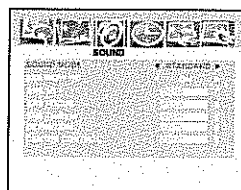
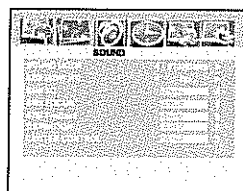

SOUND MODE

Press POINT ◀ ▶ buttons to select "STANDARD", "VOICE", "MUSIC", "MOVIE" or "PERSONAL".

SRS WOW HD

Press POINT ◀ ▶ buttons to set "ON" or "OFF". SRS WOW HD is advanced for SRS 3D, SRS FOCUS, SRS TruBass, DEFINITION and CENTER CONTROL. It is the high-tech for audio dealing researched by American SRS lab .

SRS 3D

Use to reproduce natural and splendid audio effect.
Press POINT ◀ ▶ buttons to adjust the level.

SRS FOCUS

Use to adjust vertical sound field and speech definition.
Press POINT ◀ ▶ buttons to adjust focus level.

SRS TruBass

SRS TruBass can also enhance woof effect without speech qualizer.
Press POINT ◀ ▶ buttons to adjust TruBass level.

DEFINITION

Use to adjust speech definition.
Press POINT ◀ ▶ buttons to adjust definition level.

CENTER CONTROL

Use to adjust aural perceptivity and let you feel stereophonics.
Press POINT ◀ ▶ buttons to adjust the level.

MENU OPERATION (TV/ AV mode)

TIMER

- 1 Press MENU button and the main menu will appear. Press POINT ◀ ▶ buttons to select "TIMER", and will display TIMER menu.
- 2 Press POINT ▲ ▼ buttons to select the item desired.
- 3 Press POINT ◀ ▶ buttons to adjust value.
 - Press BACK button to return to the previous menu.
 - Press MENU button or wait for 5-60 seconds (refer to "DURATION" on page 33) to exit menu operation.

SCREEN MENU

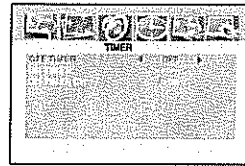
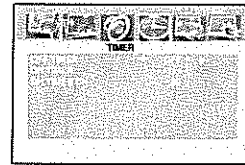

OFF TIMER

Once OFF TIMER has been set, when the set time is reached, the TV will shift to stand-by status.

To select "OFF", "30 min", "60 min", "90 min" or "120 min" with POINT ◀ ▶ buttons.

To cancel "OFF TIMER", you can choose any option by the following ways.

- Setting "OFF" in OFF TIMER.
- Pressing POWER ON/OFF button on Side Controls or on Remote Control.

ON TIMER

Once ON TIMER has been set, you won't miss any opportunity to watch the program you like.

To set ON TIMER, you can set any time by NUMERIC buttons.

To cancel "ON TIMER MODE", you can choose any option by the following ways.

- Setting "- : -" in ON TIMER by press "0" button repeatedly.
- Disconnecting the AC power cord.

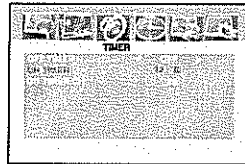

ON TIMER CH

This function is only active that ON TIMER has been set. When ON TIMER is reach, the TV will turn on and enter the channel position you set directly .

To set channel position, you can set any channel position by NUMERIC buttons (Refer to "DIRECT SELECTION" on page 16.).

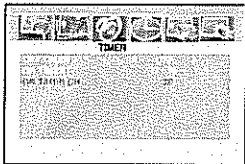

⚠ Note:

- TIMER menu cannot be selected in USB mode.
- OFF TIMER and ON TIMER will be automatically cancelled during searching channels.
- The settings for OFF TIMER and ON TIMER will be automatically cancelled after the settings has been operated for one time.
- The LCD TV will turn off automatically if it has not been executed any operation in 2 hours.

MENU OPERATION (TV/ AV mode)

OSD

- 1 Press MENU button and the main menu will appear. Press POINT ◀ ▶ buttons to select "OSD", and will display OSD menu.
- 2 Press POINT ▲ ▼ buttons to select the item desired.
- 3 Press POINT ◀ ▶ buttons to adjust value.
 - Press BACK button to return to the previous menu.
 - Press MENU button or wait for 5~60 seconds (refer to "DURATION" on page 33) to exit menu operation.

SCREEN MENU

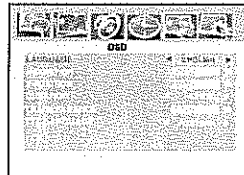
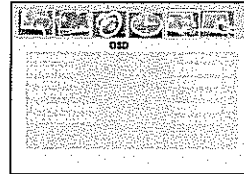

LANGUAGE

Press POINT ◀ ▶ buttons to choose ENGLISH, ARABIC or RUSSIAN.

H-POSITION

OSD moves to the left side when POINT ◀ button is pressed.
OSD moves to the right side when POINT ▶ button is pressed.
(0~100)

V-POSITION

OSD moves up when POINT ◀ button is pressed.
OSD moves down when POINT ▶ button is pressed. (0~100)

DURATION

Use this function to set the display time of the MENU when there is no operation on the TV.

Press POINT ◀ button to decrease time, press POINT ▶ button to increase time. (5~60 seconds)

TRANSPARENCE

The background of OSD darkens when POINT ◀ button is pressed. The background of OSD lightens when POINT ▶ button is pressed. (0~100)

TTX LANGUAGE

Press POINT ◀ ▶ buttons to choose WESTERN, EASTERN, RUSSIAN, ARABIC, FARSI for Language display in Teletext mode.

MENU OPERATION (TV/ AV mode)

SYSTEM

- 1 Press MENU button and the main menu will appear. Press POINT ◀ ▶ buttons to select "SYSTEM", and will display SYSTEM menu.
 - 2 Press POINT ▲ ▼ buttons to select the item desired.
 - 3 Press POINT ◀ ▶ buttons to adjust value.
- Press BACK button to return to the previous menu.
 - Press MENU button or wait for 5-60 seconds (refer to "DURATION" on page 33) to exit menu operation.

SCREEN MENU

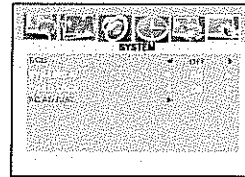
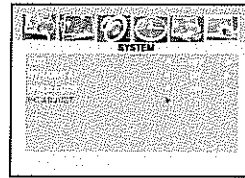

ECO

This function can automatically adjust panel's brightness by ambient brightness.
Press POINT ◀ ▶ buttons to set "AUTO", "ON" or "OFF".

DYNAMIC AI

Use to make bright and dynamic picture.
Press POINT ◀ ▶ buttons to set "ON" or "OFF".

CHILD LOCK

When CHILD LOCK is set "ON", the Side Control buttons will be locked except for POWER ON/OFF button .

⚠ Note:

- "PC ADJUST" can not be selected except for PC mode.

MENU OPERATION (PC/HDMI mode)

PICTURE

Note: The screen menu in HDMI mode will be displayed differently under different condition.

1. When the set cannot be received HDMI signal in HDMI mode, the screen menu will be displayed as right picture.
2. But when the set can be received HDMI signal in HDMI mode, the screen menu is different, and the details please refer to page 30.

- 1** Press MENU button and the main menu will appear. Press POINT ◀ ▶ buttons to select "PICTURE", and will display PICTURE menu.
- 2** Press POINT ▲ ▼ buttons to select the item desired.
- 3** Press POINT ◀ ▶ buttons to adjust value.
 - Press BACK button to return to the previous menu.
 - Press MENU button or wait for 5~60 seconds (refer to "DURATION" on page 33) to exit menu operation.

PICTURE MODE

Select "PERSONAL", "STANDARD", "DYNAMIC" or "SOFT" by pressing POINT ◀ ▶ buttons.

- PERSONAL: User presets picture adjustment in PICTURE MODE.
- STANDARD: Natural and splendid picture level preset on LCD TV.
- DYNAMIC: Bright and dynamic picture. It is suitable for nice playback, such as DVD program.
- SOFT: Inhibit strong contrast and colour, it is beneficial for eye protection.

CONTRAST

Press POINT ◀ button to decrease contrast, and POINT ▶ button to increase contrast. (0~100)

BRIGHTNESS

Press POINT ◀ button to adjust image darken, and POINT ▶ button to adjust image brighten. (0~100)

COLOUR TONE

This function is used for selecting colour temperature. Select "NORMAL", "WARM", "COOL" or "PERSONAL" with POINT ◀ ▶ buttons.

COLOUR-R

Press POINT ◀ button to lighten red tone, and POINT ▶ button to deepen red tone. (0~100)

COLOUR-G

Press POINT ◀ button to lighten green tone, and POINT ▶ button to deepen green tone. (0~100)

COLOUR-B

Press POINT ◀ button to lighten blue tone, and POINT ▶ button to deepen blue tone. (0~100)

SCREEN MENU

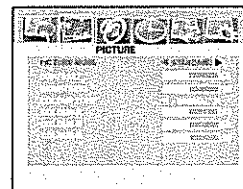
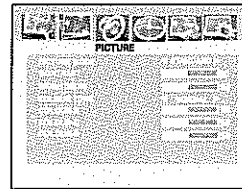

MENU OPERATION (PC/HDMI mode)

SYSTEM

- 1 Press MENU button and the main menu will appear. Press POINT ◀ ▶ buttons to select "SYSTEM", and will display SYSTEM menu.
- 2 Press POINT ▲ ▼ buttons to select the item desired.
- 3 Press POINT ◀ ▶ buttons to adjust value.
 - Press BACK button to return to the previous menu.
 - Press MENU button or wait for 5-60 seconds (refer to "DURATION" on page 33) to exit menu operation.

ECO

This function can automatically adjust panel's brightness by ambient brightness.

Press POINT ◀ ▶ buttons to set "AUTO", "ON" or "OFF".

DYNAMIC AI

Use to make bright and dynamic picture.

Press POINT ◀ ▶ buttons to set "ON" or "OFF".

CHILD LOCK

When CHILD LOCK is set "ON", the Side Control buttons will be locked except for POWER ON/OFF button .

PC ADJUST

This function is used to adjust the position of image displayed on screen. It can be selected when the LCD TV could be received PC signal and in PC mode. (Refer to "SIGNAL MODE COLUMN" on page 42.)

Press POINT ◀ ▶ buttons to enter PC SCREEN menu. It can be select "AUTO", "H-POSITION", "V-POSITION", "CLOCK" or "PHASE" to adjust.

AUTO ADJUST

Press POINT ◀ ▶ buttons, and the TV automatically detects incoming signal, and adjust itself to optimize its performance. If the image is not displayed properly, a manual adjustment is required (Refer to following adjustments).

H-POSITION

The horizontal picture position will be moved to the left side by pressing POINT ◀ button. And it will be moved to the right side by pressing POINT ▶ button. (0-100)

V-POSITION

The vertical picture position will be moved down side by pressing POINT ◀ button. And it will be moved up side by pressing POINT ▶ button. (0-100)

CLOCK

Eliminate flicker from the image. Press POINT ◀ ▶ buttons to adjust CLOCK. (0-100)

PHASE

Eliminate disorder from the image. Press POINT ◀ ▶ buttons to adjust PHASE. (0-100)

SCREEN MENU

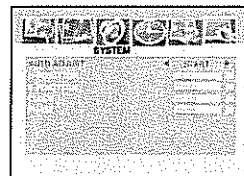
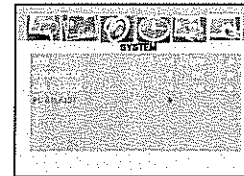
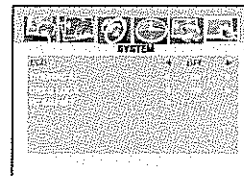
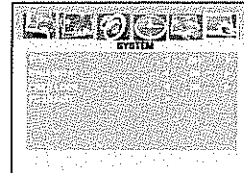

MENU OPERATION

DEALER MODE

The Dealer Mode has 7 different modes: VOLUME LOCK, TUNING LOCK, START MODE, OSD, RC, RESET and AC POWER MODE.

VOLUME LOCK

This function is used to limit the maximal volume.

TUNING LOCK

The way to prevent user from executing the Tuning function.

START MODE

The LCD TV will automatically enter to the setting mode while being turned on. You can select "OFF", "TV", "AV1-S", "AV2-DVD", "PC", "HDMI 1", "HDMI 2" or "USB" in START MODE. When it is set "OFF", it will keep the mode before being turning off.

OSD

When it is set "OFF", Corresponding OSD cannot display on the screen while operating.

RC

When it is set "OFF", the Remote Control will be locked and cannot be used.

RESET

This function returns all setting values to the factory default settings.

AC POWER MODE

You can set "STANDBY", "ON" or "LAST" in AC POWER MODE. When LCD TV is connected to an outlet with AC power cord, it will enter the status as setting.

TO DISPLAY DEALER MODE:

Press and hold Menu button on Side Controls, and then press DISPLAY button on remote controls to display Dealer mode menu.

Take the way of setting VOLUME LOCK for example:

- 1 Press POINT ◀ ▶ buttons to select a maximal volume.
- 2 Press and hold Menu button on Side Controls, and press DISPLAY button on remote controls to display Dealer mode menu.
- 3 VOLUME LOCK will be the default selection. (When you adjust others, press POINT ▲ ▼ buttons to select the item desired.)
- 4 Press POINT ◀ ▶ buttons to select "ON". (The maximal volume is the set value by step 1.)
- 5 Press menu button to exit menu operation.

REMOTE CONTROLS



Press POINT ▲/▼/◀/▶ buttons

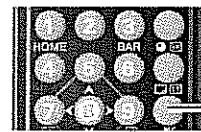

DISPLAY button

SIDE CONTROLS



MENU button

DEALER MODE MENU



APPENDIX

CLEANING LCD TV

Be sure to disconnect the AC Power cord from AC outlet before cleaning the LCD TV.
Clean your LCD TV as follows:

- Gently wipe the screen and cabinet with dry soft cloth.
- The screen is likely to be damaged if it is not maintained properly. Do not use hard objects like a hard cloth or paper. Do not use solvents or abrasions.

CAUTION :

Do not use benzene, thinner, or any volatile substances to clean the LCD TV. These chemicals may damage the cabinet finish.

FUNCTION OF PRODUCT SAFETY FEATURE

For protecting product safety, protection feature provided inside LCD TV. Refer to the following please.

AUTO POWER OFF

When a trouble is detected in the LCD TV, the protection function works and turn the LCD TV OFF automatically. When the LCD TV is turned OFF with this function, the POWER indicator becomes red and LCD TV's power cannot be turned ON.

Disconnect Power cord and contact sales dealer where you purchased the LCD TV or the service center.

To turn on LCD TV again for checking:

- 1) Disconnect Power cord from AC outlet and plug it on again.
- 2) Refer to "TURNING ON/OFF LCD TV" on Page 15 to attempt to turn on LCD TV.
If LCD TV is not turned on, disconnect Power cord and contact to service center.

APPENDIX

TROUBLESHOOTING

Before calling your dealer or service center for assistance, check the matters below once again.

1. Make sure you have connected LCD TV to your equipment as described in the section "CONNECTING LCD TV".
2. Check cable connection. Verify that all external equipment and power cords are properly connected.
3. Verify that all power is switched on.
4. If LCD TV still does not produce an image, re-start the external equipment.
5. If the image still does not appear, unplug LCD TV from the external equipment and check the external equipment. The problem may be with your graphics controller rather than with LCD TV. (When you reconnect LCD TV, remember to turn the external equipment and TV off before you power up LCD TV. Power the equipment back on in order of : LCD TV and external equipment.)
6. If the problem still exists, check the following chart.

Problem:	Try these Solutions
NO POWER	<ul style="list-style-type: none"> • Plug this LCD TV into the AC outlet. • Press ON/STAND-BY button on SIDE Control or on Remote Control to open this LCD TV. • Check POWER Indicator. If this indicator flashes, LCD TV has any trouble.
Remote Control does not work	<ul style="list-style-type: none"> • Check the batteries. • Make sure nothing is between the Remote Receiver and the Remote Control. • Make sure you are not too far from LCD TV when using Remote Control. Maximum operating range is 16.4' (5m). • Is direct sunlight or strong artificial light shining on LCD TV's Infrared Remote Receiver? Eliminate the light by closing curtains, pointing the light in a different direction, etc.
No image	<ul style="list-style-type: none"> • Check the connection between the external equipment and LCD TV. • When turning LCD TV on, it takes a few seconds to display the image. • Check the system that you select is corresponding with the external equipment or the video equipment. • Make sure the temperature is not out of the Operating Temperature (0°C ~ 40°C). • Turn off power, then turn on again, re-start LCD TV.
No sound	<ul style="list-style-type: none"> • Check Audio cable connection from Audio input source. • Adjust the Audio source. • Press VOLUME (+) button. • Press MUTE button.
There are tiny black points and/or bright point on the TV	<ul style="list-style-type: none"> • Dark or bright points of light (red, green, or blue) may appear on the screen. This is a characteristic of the LCD panels, not a malfunction of the LCD TV. • LCD panel is being produced with very high accuracy technology. There is 99.99% or more dot pixel, but there is also 0.01 % or less of dot pixel lack or dot pixel that is constantly lighted. This is not defect. • Regarding LCD panel characteristic, it may occur picture remain (look like a mirror) when the screen is changed if it displays same screen for a long time. Changing the picture or turn-off the power supply may recover. • Stripe pattern (moire, interference stripes) may show up on the screen depend on the reflected picture.
Abnormal colour of image	<ul style="list-style-type: none"> • Adjust the value of colour. • Select different colour system.

WARNING :

High voltages are used to operate this LCD TV. Do not attempt to open the cabinet.

If the problem still persists after following all operating instructions, contact the sales dealer where you purchased LCD TV or the service center. Give the model number and explain the difficulty. We will advise you how to obtain service.

APPENDIX

TECHNICAL SPECIFICATIONS

Model	LCD-42S10-HD / LCD-47S10-HD
Maximum Visible Range	LCD-42S10-HD: 106cm (Screen Diagonal Size); LCD-47S10-HD: 119cm (Screen Diagonal Size);
Picture Resolution	1920(H) x 1080(V)
Viewable Angle(L, /3)	L/R : +/- 89D; U/D : +/- 89D
Brightness	500cd/m ²
Contrast	LCD-42S10-HD: 1500:1 ; LCD-47S10-HD: 1300:1
Definition	RF Analog Signals: Horizontal≥350; Vertical≥400
Degree of Colour Coverage	≥30%
Mobile Trailer Time	LCD-42S10-HD: 6.5 ms (grey to grey) ; LCD-47S10-HD: 5 ms (grey to grey)
Voltage	AC110-242V 50/60Hz
Power Consumption	LCD-42S10-HD: 227W ; LCD-47S10-HD: 255 W
Power Management	VESA DPMS
Colour System	PAL/NTSC/NTSC4.43/SECAM
Sound System	D/K, I, M, B/G
Channel Coverage	- VHF: E2-E12, R1-R12, K1-K9, J1-J12, A2-A13 - UHF: 21-69, A14-A69, J13-J62 - CATV: S1-S41, X, Y, Z, Z+1, Z+2
Aerial input impedance	75Ω
Speaker Size	Mains: 4.5cm x 13cm x 2pcs Woofer: 8cm x 8cm x 1pcs Alt: 7.5cm x 5cm x 2pcs (Model LCD-47S10-HD only)
Sound speciality	LCD-42S10-HD: Maximum Output Power is 10W+10W+10W LCD-47S10-HD: Maximum Output Power is 12.5W+12.5W+10W Total Harmonic Distortion(THD)≤10%
Input terminals	VGA Terminal : RGB X 1 HDMI terminal: x2 Audio: Mini stereo jack x 1 (Audio input of VGA) Video: Composite video terminals x1 (1Vp-p, 75Ω) S-VIDEO input: x 1 (DIN 4-pin, Y/C separate signal input) DVD input: Component video input Y, CB/PB, CR/PR input x 1 USB input: Different value input D+, D- MINI USB input: Different value input D+, D- Audio input: (R/L) x 4 (400mVrms)
Output terminals	Video Monitor Output: x1 (1Vp-p, 75Ω) Audio Monitor Output: R/L x 1 (400mVrms, ≤1KΩ) Headphone Jack : Mini stereo jack x1
Dimensions (Width x Height x Depth)	LCD-42S10-HD: 1012mm x 698mm x 270mm (Including Stand) LCD-47S10-HD: 1125mm x 763mm x 270mm (Including Stand)
Net Weight (Including Stand)	LCD-42S10-HD: approx. 25 KG LCD-47S10-HD: approx. 29.5 KG
Operating Environment	
Operating Temperature	0°C~40°C (32°F~104°F)
Operating Humidity	20~80%
Storage Temperature	-10°C~50°C (14°F~122°F)
Storage Humidity	20~80%

- Specifications are subject to change without notice.
- The On-Screen Menu and figures in this manual may differ slightly from the product.

APPENDIX

CONFIGURATIONS OF VGA TERMINALS

VGA IN (D-SUB) TERMINAL

Terminal : D-SUB15 PIN

Connect video output terminal of LCD TV to this terminal with VGA Cable (not supplied). When connecting Macintosh computer, the MAC Adapter (not supplied) is required.

Pin Configuration

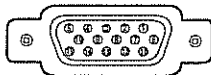

1	Red Input	9	No Connect
2	Green Input	10	Ground (Vert.sync.)
3	Blue Input	11	Sense 0
4	Sense 2	12	Sense 1
5	Ground (Horiz.sync.)	13	Horiz. sync.
6	Ground (Red)	14	Vert. sync.
7	Ground (Green)	15	Reserved
8	Ground (Blue)		

MAC ADAPTER (NOT SUPPLIED)

Set slide switches as shown in the table below depending on RESOLUTION MODE that you want to use before you turn on LCD TV and computer.

Slide Switches (1-6)

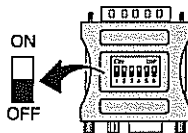

	1	2	3	4	5	6
13" Mode (640x480)	ON	ON	OFF	OFF	OFF	OFF
16" Mode (832x624)	OFF	ON	OFF	ON	OFF	OFF
19" Mode (1024x768)	OFF	ON	ON	OFF	OFF	OFF

SIGNAL MODE COLUMN (recommended)

This LCD TV can correspond to the signals below. After connecting with the computer, LCD TV can automatically recognize the signal from the connected PC(computer)/ HDMI.

PC SIGNAL MODE COLUMN (recommended)

SYSTEM MODE	PIXELS	V-Freq.(Hz)	H-Freq.(KHz)	STANDARD	SYSTEM MODE	PIXELS	V-Freq.(Hz)	H-Freq.(KHz)	STANDARD
VGA	640*350	85	37.9	VESA	SVGA	800*600	75	46.9	VESA
VGA	640*400	85	37.9	VESA	SVGA	800*600	85	53.7	VESA
VGA	720*400	85	37.9	VESA	XGA	1024*768	60	48.4	VESA
VGA	640*480	60	31.5	VESA	XGA	1024*768	70	56.5	VESA
VGA	640*480	72	37.9	VESA	XGA	1024*768	75	60	VESA
VGA	640*480	75	37.5	VESA	XGA	1132*864	75	67.5	VESA
VGA	640*480	85	43.3	VESA	WXGA	1280*768	60	47.7	VESA-GTF
SVGA	800*600	56	35.1	VESA	SXGA	1280*960	60	60	VESA
SVGA	800*600	60	37.9	VESA	SXGA	1280*1024	60	64	VESA
SVGA	800*600	72	48.1	VESA	UXGA	1600*1200	60	75	VESA

Note:

- In case LCD TV can not display properly due to the connecting cable or the graphic hardware, please make adjustments about phase, clock and so on.
 - In principle, LCD TV can not display the signal mode which not described in the above column. But sometimes it can display a signal very similar with one of the signal described.
 - If you want to change the definition and colour of PC, please select one from the column.
 - It is not the trouble of LCD TV if interference appears on the picture while switching the signal mode.
 - It is different from CRT Monitor that it is no blink of the picture when the V-Freq. of the signal is 60Hz. It is recommended to select 60Hz V-Freq. of your computer to display better pictures.
 - The Dot Clock of the computer's signal must be less than 100 MHz.
 - Specifications are subject to change without notice.
- In case of the following things, some messages will display on the screen.
- When the input signal from PC is out of the display range, "Out of range " will display.

APPENDIX

When input signal is digital from DVD terminal, refer to the chart below.

SYSTEM MODE	PIXELS	V-Freq. (HZ)	H-Freq. (KHz)
480I	720*480	60	15.75
576I	720*576	50	15.6
480P	720*480	60	31.5
576P	720*576	50	31.2
720P	1280*720	60	45
720P	1280*720	50	37.5
1080I	1920*1080	60	33.7
1080I	1920*1080	50	28.1
1080P	1920*1080	50	56.2
1080P	1920*1080	60	67.5

When input signal is digital from HDMI terminal, refer to the chart below.

NO.	Resolution	H-Freq. (KHz)	Frame Frequency
1	1920x1080	33.75KHz	30.00Hz
2	1920x1080	67.50KHz	60.00Hz
3	1920x1080	28.13KHz	25.00Hz
4	1920x1080	56.25KHz	50.00Hz
5	1280x720	45.00KHz	60.00Hz
6	1280x720	37.50KHz	60.00Hz
7	720x480	31.50KHz	59.98Hz
8	720x576	31.25KHz	50.00Hz
Audio Freq. Format : 16bit/20bit/24bit			
HDMI™ (V.1.3 with Deep Color)			

When input signal is digital from USB terminal, refer to the chart below.

Support Form	
Photo	JPEG, BMP, GIF
Music	MP3, WMA
Movie	MPEG1, AVI, MPEG4
Text	TXT, LRC
USB Device	FAT32

TABLE OF TOXIC ELEMENT FOR PRODUCTION

Parts Name	Toxic Element					
	Pb	Hg	Cd	Cr(VI)	PBB	PBDE
Plastic	○	○	○	○	○	○
Display Screen	×	×	○	○	○	○
Circuit Board	×	○	×	○	○	○
Hardware	○	○	○	○	○	○
Copper Alloy	×	○	○	○	○	○
Remote Control	×	○	○	○	○	○
Other Parts (eg. :pasteur,line etc)	○	○	○	○	○	○
○: The symbol means the content of toxic materials in all of homogeneous materials must meet requirement of SJ/T11383-2008 standard. X: The symbol means the content of toxic materials in all of homogeneous materials beyonds SJ/T11383-2008 standard.						

APPENDIX

Uninstalling Stand Base

⚠ CAUTION IN UNINSTALLING STAND BASE

- Through in uninstalling work, handling with more than two people is recommended.
- When holding (moving or lifting) the LCD Display, hold the display's body. Do not handle the LCD TV by holding the attached accessory parts (speakers), otherwise it may result in damage.
- Before uninstalling, provide a desk (or a part of it) which is strong enough to support the weight of the LCD TV and this stand. The desk must be larger than the LCD Display screen size. The desk's surface must be flat and maintained with soft material (such as a blanket) for protecting the screen surface.
- Before putting the LCD Display on the desk, make sure there is no object on it. Leaving any object under the screen may cause damage on the screen.
- The LCD TV with this stand should be uninstalled on flat and level place. Do not place on such as a non flat, unlevel or unstable cart or stand. The display may fall, causing not only serious damage to the products but serious injury to a person.

⚠ SAFETY NOTE

For correct installing, mounting and uninstalling LCD TV Stand, it is strongly recommended to use a trained, authorized dealer. Failure to follow correct procedures could result in damage to the equipment or injury to the installer.

Uninstalling Stand Base

- 1 Place the LCD TV screen facing down on a flat surface place where maintained with soft materials (such as a blanket) for protecting the display screen.
- 3 Pull the stand base out from the cabinet after all screws already removed.

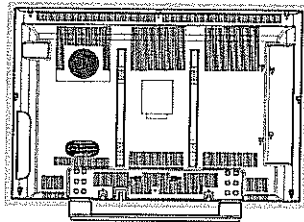

- 2 Release screw in 12 holes with screw driver.

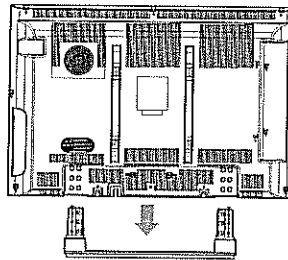
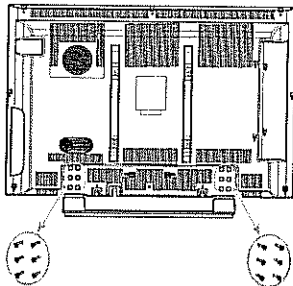

APPENDIX

Uninstalling Stand Base (Continued)

- 4** Cover the holes where you remove the stand base from the dust etc. by paste the deck label (supplied) to these holes.

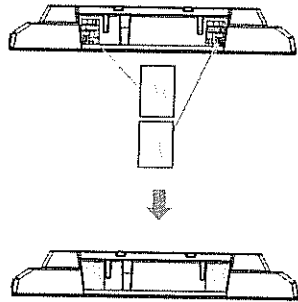

- 5** Uninstalling the stand base is completed now.

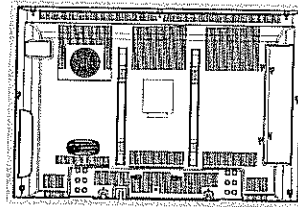

Note

Note

Part No. 1AA6P1P5559-B N5ZW-B (UH3-B)

SANYO

SANYO Electronics CO., Ltd.

Free Manuals Download Website

<http://myh66.com>

<http://usermanuals.us>

<http://www.somanuals.com>

<http://www.4manuals.cc>

<http://www.manual-lib.com>

<http://www.404manual.com>

<http://www.luxmanual.com>

<http://aubethermostatmanual.com>

Golf course search by state

<http://golfingnear.com>

Email search by domain

<http://emailbydomain.com>

Auto manuals search

<http://auto.somanuals.com>

TV manuals search

<http://tv.somanuals.com>