

Multimedia Plasma Monitor

MODEL **PDP-32H1ENV**

PDP-32H1AN

PDP-32H1EN

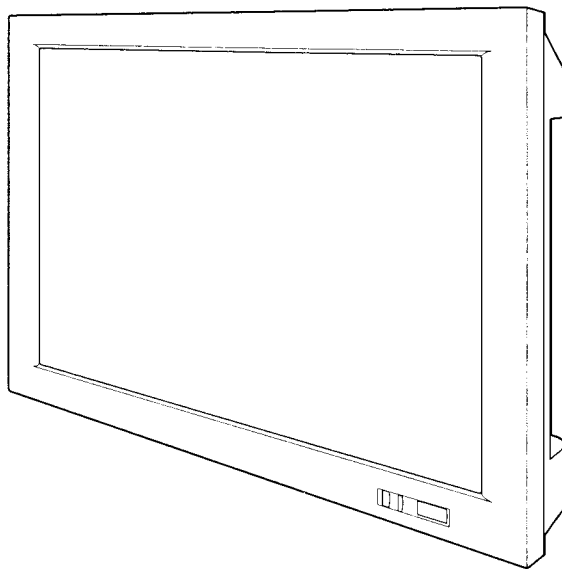

Owner's Manual

TO THE OWNER

Before operating this Plasma Monitor, read this manual thoroughly and operate the Plasma Monitor properly. This Plasma Monitor provides many convenient features and functions. Operating the Plasma Monitor properly enables you to manage those features and maintains it in better condition for a considerable time. Improper operation may result in not only shortening the product-life, but also malfunctions, fire hazard, or other accidents.

If your Plasma Monitor seems to operate improperly, read this manual again, check operations and cable connections and try the solutions in the "Trouble-shooting" section of the end of this booklet. If the problem still persists, contact the sales dealer where you purchased the Plasma Monitor or the service center.



SAFETY PRECAUTIONS

WARNING : TO REDUCE THE RISK OF FIRE OR ELECTRIC SHOCK, DO NOT EXPOSE THIS APPLIANCE TO RAIN OR MOISTURE.

- This Plasma Monitor should be set in the way indicated. If not, it may result in a fire hazard.
- Take appropriate space on the top, sides and rear of the Plasma Monitor cabinet for allowing air circulation and cooling the Plasma Monitor. Minimum distance should be taken. If the Plasma Monitor is to be built into a compartment or similarly enclosed, the minimum distances must be maintained. Do not cover the ventilation slot on the Plasma Monitor. Heat build-up can reduce the life of your Plasma Monitor, and can also be dangerous.
- If the Plasma Monitor is not to be used for an extended time, unplug the Plasma Monitor from the power outlet.

READ AND KEEP THIS OWNER'S MANUAL FOR LATER USE.

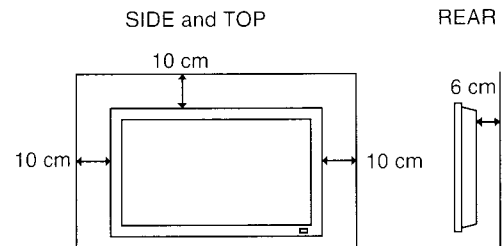

CAUTION IN INSTALLING

- Handle the Plasma Monitor carefully when installing it and do not drop.
- Locate set away from heat, excessive dust, and direct sunlight.
- For correct installation and mounting it is strongly recommended to use a trained, authorized dealer. Failure to follow correct mounting procedures could result in damage to the equipment or injury to the installer.

NOTE :

When Plasma Monitor is not used for a long period of time, unlighting dots may be observed. This is caused by characteristic of the Plasma Monitor. If this occurs, turn the Plasma Monitor on and leave it on about 1 hour. These dots will gradually disappear.



CAUTION
RISK OF ELECTRIC SHOCK
DO NOT OPEN



CAUTION : TO REDUCE THE RISK OF ELECTRIC SHOCK, DO NOT REMOVE COVER (OR BACK). NO USER-SERVICEABLE PARTS INSIDE. REFER SERVICING TO QUALIFIED SERVICE PERSONNEL.



THIS SYMBOL INDICATES THAT DANGEROUS VOLTAGE CONSTITUTING A RISK OF ELECTRIC SHOCK IS PRESENT WITHIN THIS UNIT.



THIS SYMBOL INDICATES THAT THERE ARE IMPORTANT OPERATING AND MAINTENANCE INSTRUCTIONS IN THE OWNER'S MANUAL WITH THIS UNIT.

SAFETY INSTRUCTIONS

All the safety and operating instructions should be read before the product is operated.

Read all of the instructions given here and retain them for later use. Unplug this Plasma Monitor from AC power supply before cleaning. Do not use liquid or aerosol cleaners. Clean only with dry cloth.

Follow all warnings and instructions marked on the Plasma Monitor.

For added protection to the Plasma Monitor during a lightning storm, or when it is left unattended and unused for long periods of time, unplug it from the wall outlet. This will prevent damage due to lightning and power line surges.

Do not expose this Plasma Monitor to rain or use near water... for example, in a wet basement, near a swimming pool, etc...

The Plasma Monitor shall not be exposed to dripping or splashing. No objects filled with liquids, such as vases, shall be placed on the Plasma Monitor.

Only use attachments/accessories specified by the manufacturer.

Do not place this Plasma Monitor on an unstable cart, stand, or table. The Plasma Monitor may fall, causing serious injury to a child or adult, and serious damage to the Plasma Monitor. Use only with a cart or stand recommended by the manufacturer, or sold with the Plasma Monitor.

CAUTION:

This Plasma Monitor for use only with following Stand and Mount Unit. Use with other stands or mount units is capable of resulting in instability causing possible injury.

SANYO Table top stand	KA-TD-H10S
SANYO Floor stand	KA-TD-H10W
SANYO Tilt mount unit	KA-TI-H10
SANYO Wall mount unit	KA-WA-H10WV
SANYO Ceiling mount unit	KA-CH-H10

An appliance and cart combination should be moved with care. Quick stops, excessive force, and uneven surfaces may cause the appliance and cart combination to overturn.



Slots and openings in the back and top of the cabinet are provided for ventilation, to insure reliable operation of the equipment and to protect it from overheating.

Do not block any ventilation openings. Install in accordance with the manufacturer's instructions. Do not install near any heat sources such as radiators, heat registers, stoves, or other apparatus (including amplifiers) that produce heat.

This Plasma Monitor should not be placed in a built-in installation such as a book case unless proper ventilation is provided.

Never push objects of any kind into this Plasma Monitor through cabinet slots as they may touch dangerous voltage points or short out parts that could result in a fire or electric shock. Never spill liquid of any kind on the Plasma Monitor.

This Plasma Monitor should be operated only from the type of power source indicated on the marking label. If you are not sure of the type of power supplied, consult your authorized dealer or local power company.

Do not overload wall outlets and extension cords as this can result in fire or electric shock. Do not allow anything to rest on the power cord. Protect the power cord from being walked on or pinched particularly at plugs, convenience receptacles, and the point where they exit from the apparatus.

Do not attempt to service this Plasma Monitor yourself as opening or removing covers may expose you to dangerous voltage or other hazards. Refer all servicing to qualified service personnel.

Unplug this Plasma Monitor from wall outlet and refer servicing to qualified service personnel under the following conditions:

- When the power cord or plug is damaged or frayed.
- If liquid has been spilled into the Plasma Monitor.
- If the Plasma Monitor has been exposed to rain or water.
- If the Plasma Monitor does not operate normally by following the operating instructions. Adjust only those controls that are covered by the operating instructions as improper adjustment of other controls may result in damage and will often require extensive work by a qualified technician to restore the Plasma Monitor to normal operation.
- If the Plasma Monitor has been dropped or the cabinet has been damaged.
- When the Plasma Monitor exhibits a distinct change in performance-this indicates a need for service.

When replacement parts are required, be sure the service technician has used replacement parts specified by the manufacturer that have the same characteristics as the original part. Unauthorized substitutions may result in fire, electric shock, or injury to persons.

Upon completion of any service or repairs to this Plasma Monitor, ask the service technician to perform routine safety checks to determine that the Plasma Monitor is in safe operating condition.

AC Power Cord has a grounding-type AC line plug. This is a safety feature to be sure that the plug will fit into the power outlet. Do not try to defeat this safety feature. Should you be unable to insert the plug into the outlet, contact your electrician.

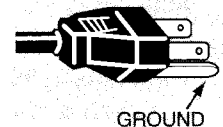

Voor de klanten in Nederland



Bij dit product zijn batterijen geleverd. Wanneer deze leeg zijn, moet u ze niet weggooien maar inleveren als KCA.

COMPLIANCES

European Norm Compatibility / CE

This machine is provided with the CE-mark and therewith corresponding to the norms that are valid for its operation at present. Thus the effective guidelines on the electromagnetic compatibility 89/336/EEG and safety regulations according to low voltage guideline 73/23/EEG and 93/68/EEG are guaranteed. Mutual disturbances with other electronic appliances are normally excluded, if those also are in accordance with valid norms. Sporadically disturbances cannot, however, be excluded. The product is in conformity with the directives of the valid European guidelines.

Declaration of Conformity

Model Number : PDP-32H1ENV/PDP-32H1AN/PDP-32H1EN
Trade Name : Sanyo
Responsible party : SANYO FISHER COMPANY
Address : 21605 Plummer Street, Chatsworth, California 91311
Telephone No. : (818)998-7322

- This device complies with Part 15 of the FCC Rules. Operation is subject to the following two conditions :
- (1) this device may not cause harmful interference, and
 - (2) this device must accept any interference received, including interference that may cause undesired operation.

AC POWER CORD REQUIREMENT

The AC Power Cord supplied with this Plasma Monitor meets the requirement for use in the country you purchased it.

AC Power Cord for the United States and Canada :

AC Power Cord used in the United States and Canada is listed by the Underwriters Laboratories (UL) and certified by the Canadian Standard Association (CSA).

AC Power Cord has a grounding-type AC line plug. This is a safety feature to be sure that the plug will fit into the power outlet. Do not try to defeat this safety feature. Should you be unable to insert the plug into the outlet, contact your electrician.

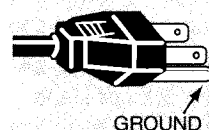

AC Power Cord for the United Kingdom :

This cord is already fitted with a moulded plug incorporating a fuse, the value of which is indicated on the pin face of the plug. Should the fuse need to be replaced, an ASTA approved BS 1362 fuse must be used of the same rating, marked thus \diamond . If the fuse cover is detachable, never use the plug with the cover omitted. If a replacement fuse cover is required, ensure it is of the same colour as that visible on the pin face of the plug (i.e. red or orange). Fuse covers are available from the Parts Department indicated in your User Instructions.

If the plug supplied is not suitable for your socket outlet, it should be cut off and destroyed.

The end of the flexible cord should be suitably prepared and the correct plug fitted. (See Over)

WARNING : A PLUG WITH BARED FLEXIBLE CORD IS HAZARDOUS IF ENGAGED IN A LIVE SOCKET OUTLET.

The Wires in this mains lead are coloured in accordance with the following code:

Green-and-yellow Earth
Blue Neutral
Brown Live

As the colours of the wires in the mains lead of this apparatus may not correspond with the coloured markings identifying the terminals in your plug proceed as follows:

The wire which is coloured green-and-yellow must be connected to the terminal in the plug which is marked by the letter E or by the safety earth symbol \perp or coloured green or green-and-yellow.

The wire which is coloured blue must be connected to the terminal which is marked with the letter N or coloured black.

The wire which is coloured brown must be connected to the terminal which is marked with the letter L or coloured red.

WARNING : THIS APPARATUS MUST BE EARTHED.

THE SOCKET-OUTLET SHOULD BE INSTALLED NEAR THE EQUIPMENT AND EASILY ACCESSIBLE.

TABLE OF CONTENTS

FEATURES AND DESIGN	6	COMPUTER MODE	28
		SELECTING INPUT SOURCE	28
		SELECTING COMPUTER SYSTEM	28
		PC ADJUSTMENT	29
PREPARATION	7		
NAME OF EACH PART OF PLASMA MONITOR	7		
SETTING-UP PLASMA MONITOR	9	VIDEO MODE	32
		SELECTING INPUT SOURCE	32
		SELECTING VIDEO SYSTEM	33
CONNECTING PLASMA MONITOR	11		
TERMINALS OF PLASMA MONITOR	11		
CONNECTING TO VIDEO EQUIPMENT	13	SETTING	34
CONNECTING TO COMPONENT VIDEO EQUIPMENT	14	SCREEN SAVER FUNCTION	34
CONNECTING TO COMPUTER	15	SETTING MENU	35
		CLEANING THE PLASMA MONITOR	36
BEFORE OPERATION	16		
OPERATION OF REMOTE CONTROL	16	APPENDIX	37
OPERATING ON-SCREEN MENU	18	TROUBLESHOOTING	37
		FUNCTIONS OF PRODUCT SAFETY FEATURES	38
		INFORMATION MENU	39
		TECHNICAL SPECIFICATIONS	40
BASIC OPERATION	20		
TURNING ON / OFF PLASMA MONITOR	20		
OFF TIMER	21		
SELECTING INPUT SOURCE	22		
PICTURE IMAGE LEVEL SELECT	23		
IMAGE LEVEL ADJUSTMENT	24		
WIDE SCREEN OPERATIONS	25		
SOUND ADJUSTMENT	27		

TRADEMARKS

- Apple, Macintosh, and PowerBook are trademarks or registered trademarks of Apple Computer, Inc.
- IBM and PS/2 are trademarks or registered trademarks of International Business Machines, Inc.
- Each name of corporations or products in the owner's manual is a trademark or a registered trademark of its respective corporation.

FEATURES AND DESIGN

This Plasma Monitor is designed with the most advanced technology. The Plasma Monitor utilizes built-in multimedia features, a palette of 16.77 million colors, and Plasma Display Panel technology.

◆ High Definition Plasma Panel

This Plasma Monitor has 852 x 1,024 dots High Definition Plasma Display Panel. This Plasma Display Panel has High brightness and wide viewing angle.

◆ Compatibility

This Plasma Monitor widely accepts various video and computer input signals including;

- **6 Color Systems**
NTSC, PAL, SECAM, NTSC 4.43, PAL-M or PAL-N color system can be connected.
- **Component Video**
Component video signals, such as a DVD player output high definition TV signals including 480i, 480p, 575i, 720p, 1035i or 1080i, can be connected.
- **S-Video**
S-Video signals, such as a S-VHS VCR output signals, can be connected.
- **Computers**
IBM-compatible and Macintosh computers.

◆ Multi-Scan System

This Plasma Monitor has Multi-Scan System to conform to almost all computer output signals quickly. There is no need for complicated manual adjustment of frequency and other settings.

◆ Input Terminals

- **D-SUB, RGB input for PC (Up to XGA)**
- **Component input for DVD**
- **S-Video / Video for VCR**

◆ Dynamic AI (Automatic Image control)

This Plasma Monitor provides AI (Automatic Imaging control) circuit which compensates picture contrast and brightness levels dynamically and reproduces bright and high-contrast pictures.

◆ RS232C Terminal

This Plasma Monitor can be controlled through RS232C terminal. It allows you to use other AV systems.

◆ Slim design

Slim design allows you to get the most advantage. When installing the Plasma Monitor in limited space, and it is well designed for easy installation.

CARE FOR USING PLASMA MONITOR

- Do not bump or scratch the panel surface as this causes flaws on the surface of the screen.
- Do not display one non-movement still picture on the screen for a long time. Otherwise, an afterimage or ghost may appear on a part of the panel. To prevent this symptoms, apply the screen saver function in the Plasma Monitor.
- There may be some tiny black points and/or blight points on the Plasma Display Panel. These points are normal.

** NOTES ON OWNER'S MANUAL

This owner's manual described with the models PDP-32H1ENV and PDP-32H1AN. Some of terminals are not provided on model PDP-32H1EN. (Refer to the terminal figure on page 12.)

NAME OF EACH PART OF PLASMA MONITOR

FRONT

PLASMA DISPLAY
PANEL

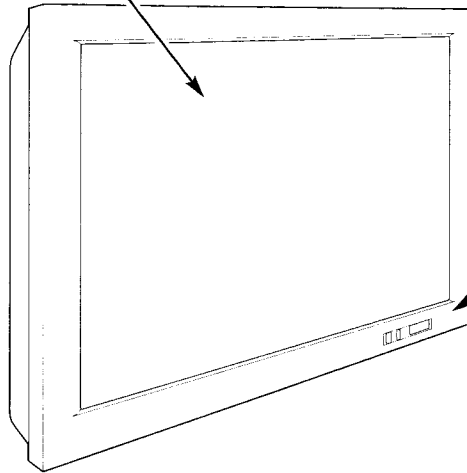

FRONT CONTROLS
AND INDICATORS

MENU BUTTON

Used to select MENU operation. (P18)

CURSOR ◀▶ BUTTON

Used to set and adjust the menu data on On-Screen Menu. (P18)

FRONT CONTROLS

OK BUTTON

Used to execute the selected menu on On-Screen Menu. (P18)

CURSOR ▼▲ BUTTON

Used to select the menu on On-Screen Menu. (P18)

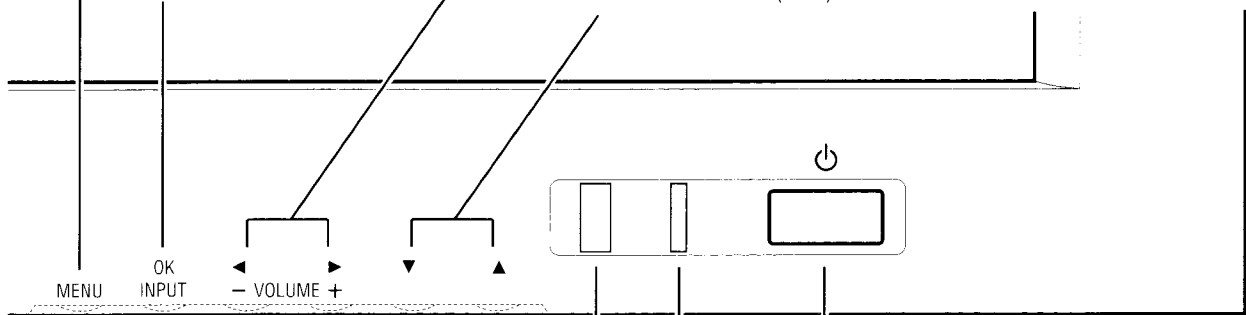

VOLUME BUTTONS

Used to adjust volume. (P27)

MAIN ON/OFF SWITCH

Used to turn Plasma Monitor on or off. (P20)

INPUT BUTTON

Used to select input source. (P22)

INFRARED REMOTE RECEIVERS

POWER INDICATOR

Light in green when power is on.
Light in red when power is off with Remote Control (standby mode), or the Plasma Monitor is in Power Save mode. (P20)

NAME OF EACH PART OF PLASMA MONITOR

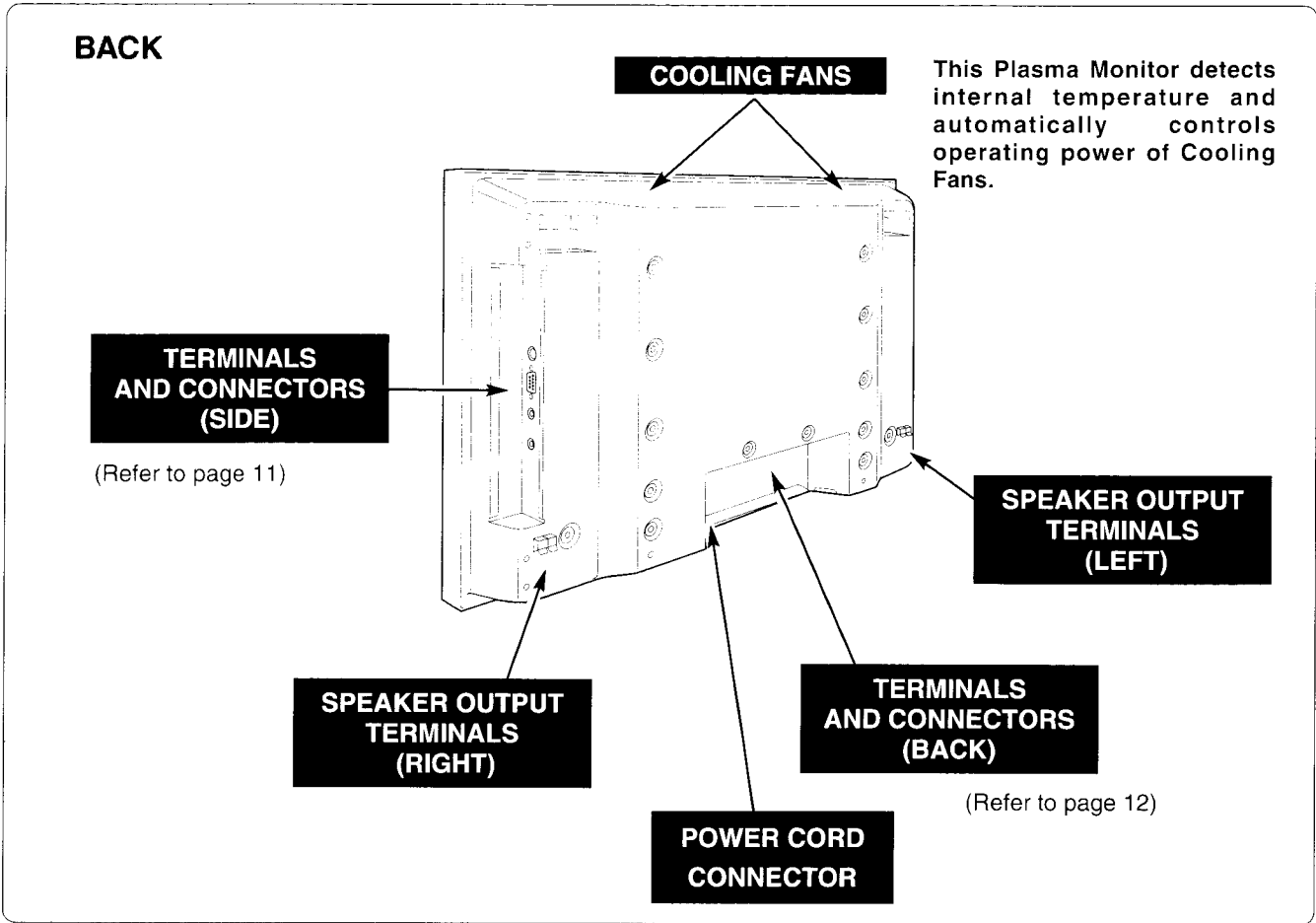

NOTES ON USING PLASMA MONITOR

For using this Plasma Monitor, Optional Stand or Mounting Bracket is needed. Those optional units are not included within this Monitor Set. Your Sales dealer can advise you of best optional unit for using Plasma Monitor. Contact your sales dealer for detail.

INSTALL PLASMA MONITOR IN PROPER DIRECTION

This Plasma Monitor can be installed in two ways, normal (horizontal) and vertical. **DO NOT INSTALL UNSPECIFIED DIRECTION, OR COOLING AIR CIRCULATION IS PREVENTED AND IT MAY RESULT IN FIRE HAZARD.**

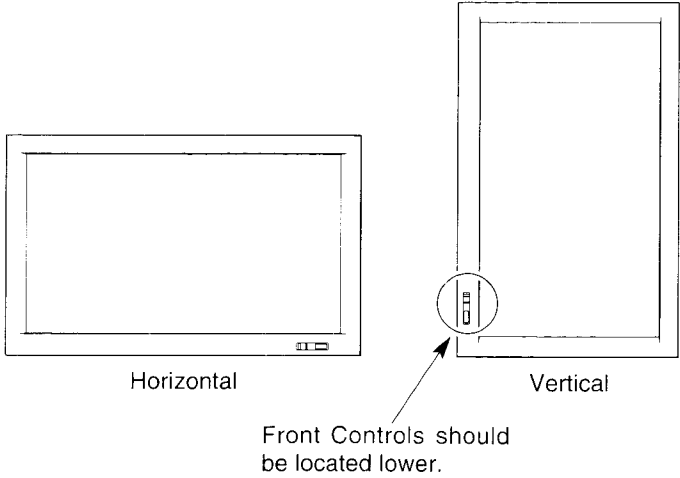

SETTING-UP PLASMA MONITOR

CONNECTING AC POWER CORD

This Plasma Monitor uses nominal input voltages of 100-120 V or 200-240 V AC. The Plasma Monitor automatically selects the correct input voltage. It is designed to work with single-phase power systems having a grounded neutral conductor. To reduce the risk of electrical shock, do not plug into any other type of power system.

Consult your authorized dealer or service station if you are not sure of the type of power supply being in use. Connect Plasma Monitor with the peripheral equipment before turning Plasma Monitor on. (Refer to pages 13 ~ 15 for connection.)

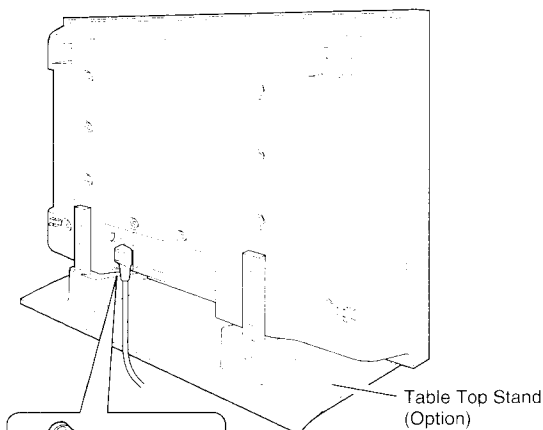

Connect AC Power Cord (supplied) to Plasma Monitor. The AC outlet must be near this equipment and must be easily accessible.



CAUTION

For safety, unplug the AC Power Cord when the appliance is not used.

NOTE ON THE POWER CORD

The AC Power Cord must meet the requirement of the country where you use the Plasma Monitor. Confirm the AC plug type with the chart below and the proper AC Power Cord must be used. If the supplied AC Power Cord does not match the AC outlet, contact your sales dealer.

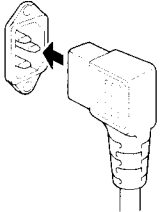
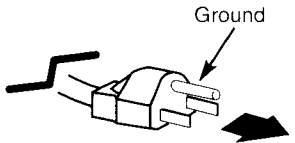
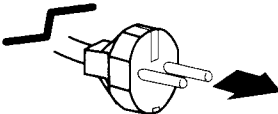
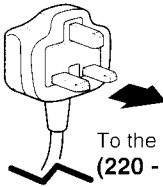
Plasma Monitor side	AC Outlet side		
 <p data-bbox="168 1556 464 1602">To the POWER CORD CONNECTOR on Plasma Monitor</p>	<p data-bbox="500 1325 805 1350">For the U.S.A. and Canada</p>  <p data-bbox="630 1528 797 1583">To the AC Outlet. (120 V AC)</p>	<p data-bbox="833 1325 1130 1350">For Continental Europe</p>  <p data-bbox="954 1549 1133 1604">To the AC Outlet. (220 - 240 V AC)</p>	<p data-bbox="1235 1325 1390 1350">For the U.K.</p>  <p data-bbox="1284 1520 1463 1575">To the AC Outlet. (220 - 240 V AC)</p>

ATTACHING THE FERRITE CORES

When you connect The Plasma Monitor to AC outlet, attach the supplied ferrite cores. Set the ferrite cores on the both ends of the AC power cord. Close the lid tightly until the clamps click.

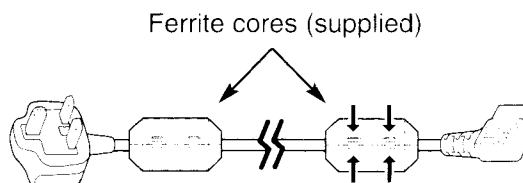

INSTALLATION OF OPTIONAL SPEAKERS AND STAND

Please read the each option's instruction manual (or installation manual) for the installation.



CAUTION IN INSTALLATION

- Through installation work, handling with more than two people is recommended.
- When holding (moving or lifting) the Plasma Monitor, hold the Monitor's body. Do not handle it by holding the attached accessory parts (the Speakers), otherwise damage could be result.
- Provide space that enough larger than the screen size. The surface must be flat and maintained with soft material (cloth or blanket) for protecting the screen surface.
- Before placing the Plasma Monitor Screen facing down, make sure there is no object under the screen. Leaving any object may cause damage on the screen surface.

SPEAKERS (OPTIONAL)

Place the Speakers to each side of the Plasma Monitor and attach Right and Left brackets with the specified screws. Mount each screw on proper screw hole position and fix it securely.

Connect the red wire to the red terminal on both of the Plasma Monitor and the speakers and connect the black wire to the black terminal to make correct polarity.

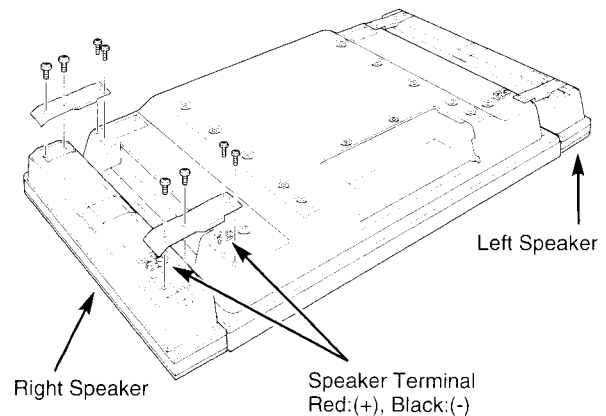
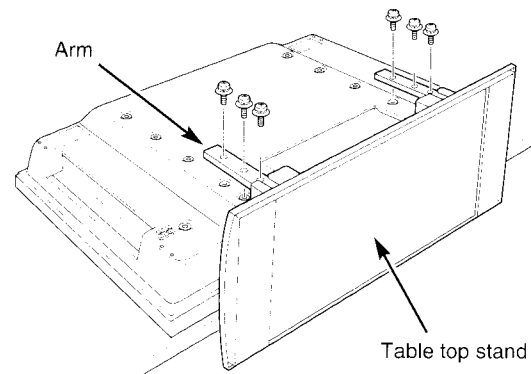

TABLE TOP STAND (OPTIONAL)

Assemble Table top stand according to the installation manual of the stand.

Mount the stand on the back of the Plasma Monitor by fixing the Arms with screws (3 pcs. for each arm).



CONNECTING PLASMA MONITOR

TERMINALS OF PLASMA MONITOR

This Plasma Monitor has INPUT TERMINALS and OUTPUT TERMINALS on its side and back, for connecting computers and video equipment. Refer to the figure on pages 13 to 15 and connect properly.

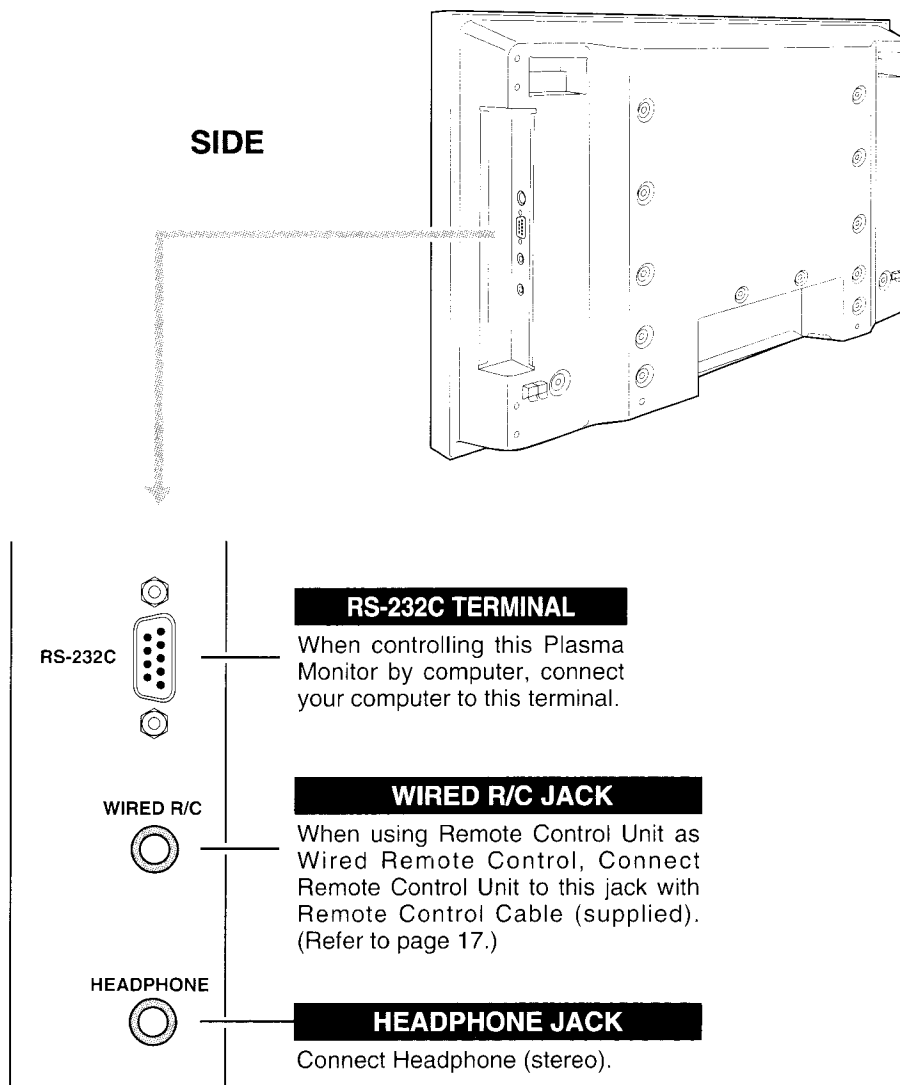

CONNECTING PLASMA MONITOR

BACK

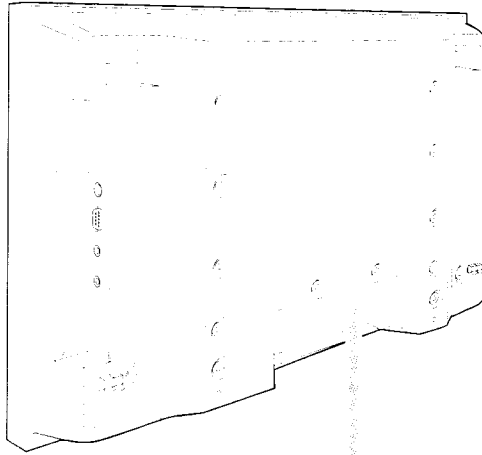

VIDEO1 INPUT JACKS

Connect video and audio outputs from video equipment. (Refer to P13.)

- S-VIDEO (Mini DIN 4-type)
- VIDEO (RCA-type)
- AUDIO R and L (MONO) (RCA-type)

VIDEO1 IN

PC INPUT TERMINALS

Connect computer outputs to this terminals. (Refer to P15.)

- RGB (D-SUB)
- AUDIO R/L (Stereo Mini Jack)

PC IN

**
SEE NOTE BELOW

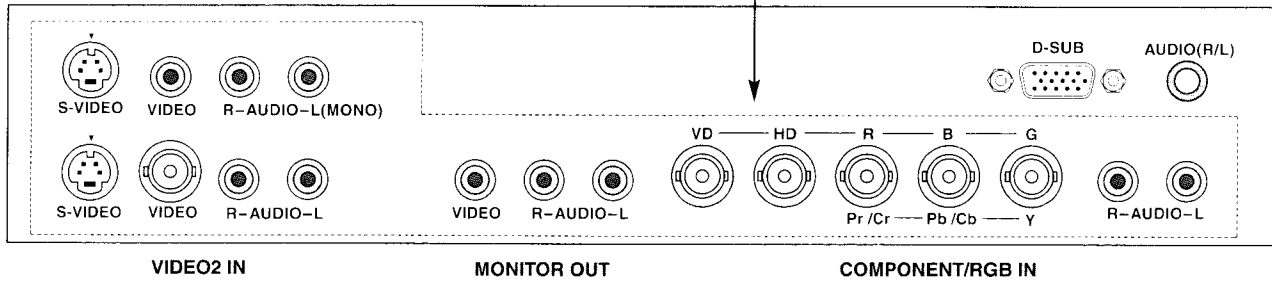

VIDEO2 IN

MONITOR OUT

COMPONENT/RGB IN

VIDEO2 INPUT JACKS

Connect video and audio outputs from video equipment. (Refer to P13.)

- S-VIDEO (Mini DIN 4-type)
- VIDEO (BNC-type)
- AUDIO R and L (RCA-type)

MONITOR OUTPUT JACKS

Connect another monitor, video recorder or external audio amplifier to these jacks. (Refer to P13-15.)

- VIDEO (RCA-type)
- AUDIO R and L (RCA-type)

COMPONENT/RGB INPUT JACKS

Connect analog RGB signal outputs or component video outputs to these jacks. Connect analog RGB signal outputs to R, G, B, HD and VD jacks. (Refer to P15.) Connect component video outputs to Y, Pb/Cb and Pr/Cr jacks. (Refer to P14.)

- RGB/COMPONENT (BNC-type)
- AUDIO R and L (RCA-type)

**

NOTE : Those terminals are not provided on model PDP-32H1EN.

CONNECTING TO VIDEO EQUIPMENT

NOTE : Models PDP-32H1ENV and PDP-32H1AN only.

Cables used for connection (Cables are not supplied with this Plasma Monitor.)

- 21-PIN Video Cable (RCA x 6)
- Video Cable (RCA x 1)
- Video Cable (RCA x 3)
- S-VIDEO Cable
- Audio Cable (RCA x 2)

NOTE :
When connecting Plasma Monitor, AC Power Cords of both Plasma Monitor and external equipment should be disconnected from AC outlet.

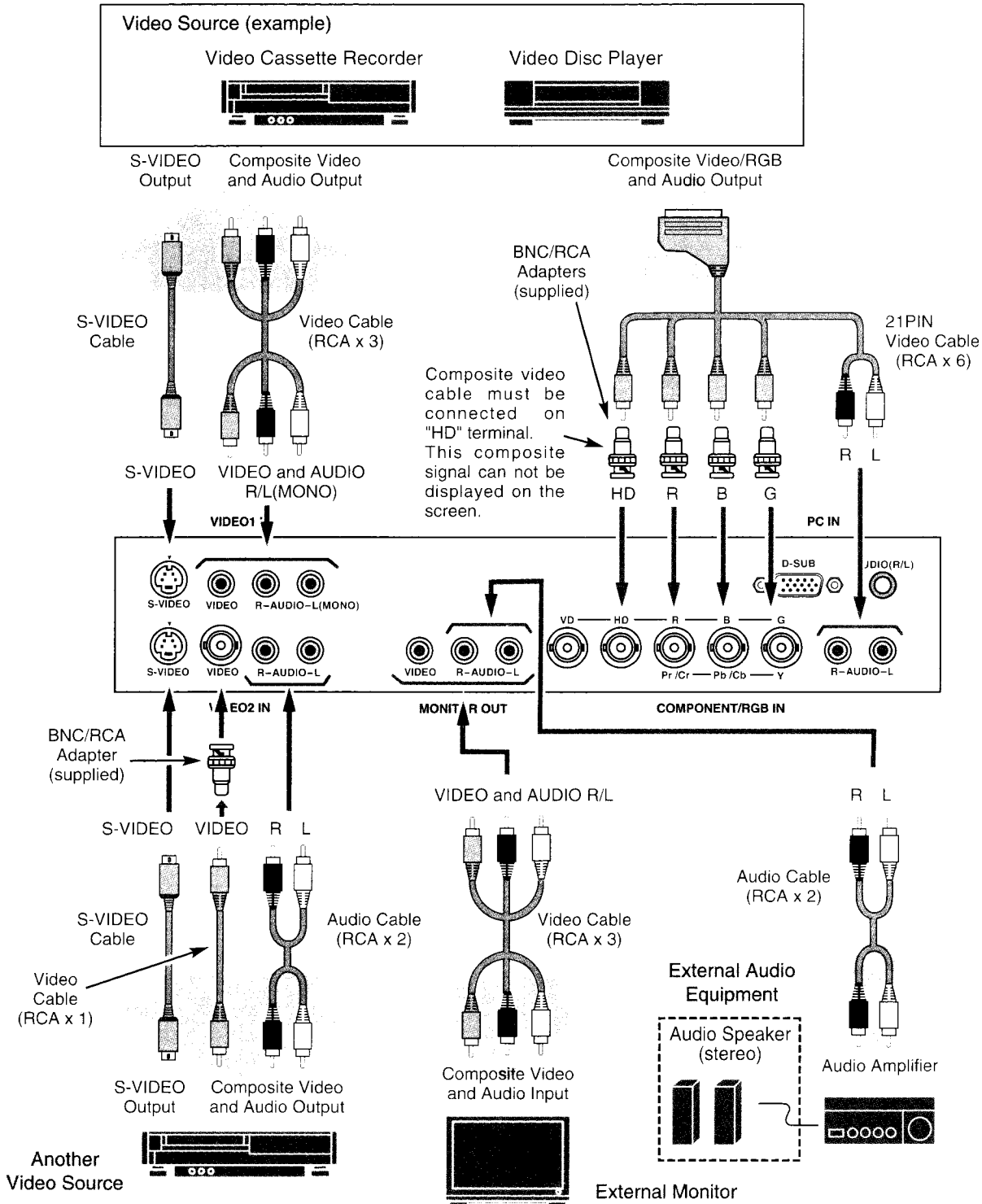

CONNECTING TO COMPONENT VIDEO EQUIPMENT

NOTE : Models PDP-32H1ENV and PDP-32H1AN only.

Cables used for connection (Cables are not supplied with this Plasma Monitor.)

- Video Cable (RCA x 3) or (BNC x 3)
- Audio Cable (RCA x 2)



NOTE :
When connecting Plasma Monitor, AC Power Cords of both Plasma Monitor and external equipment should be disconnected from AC outlet.

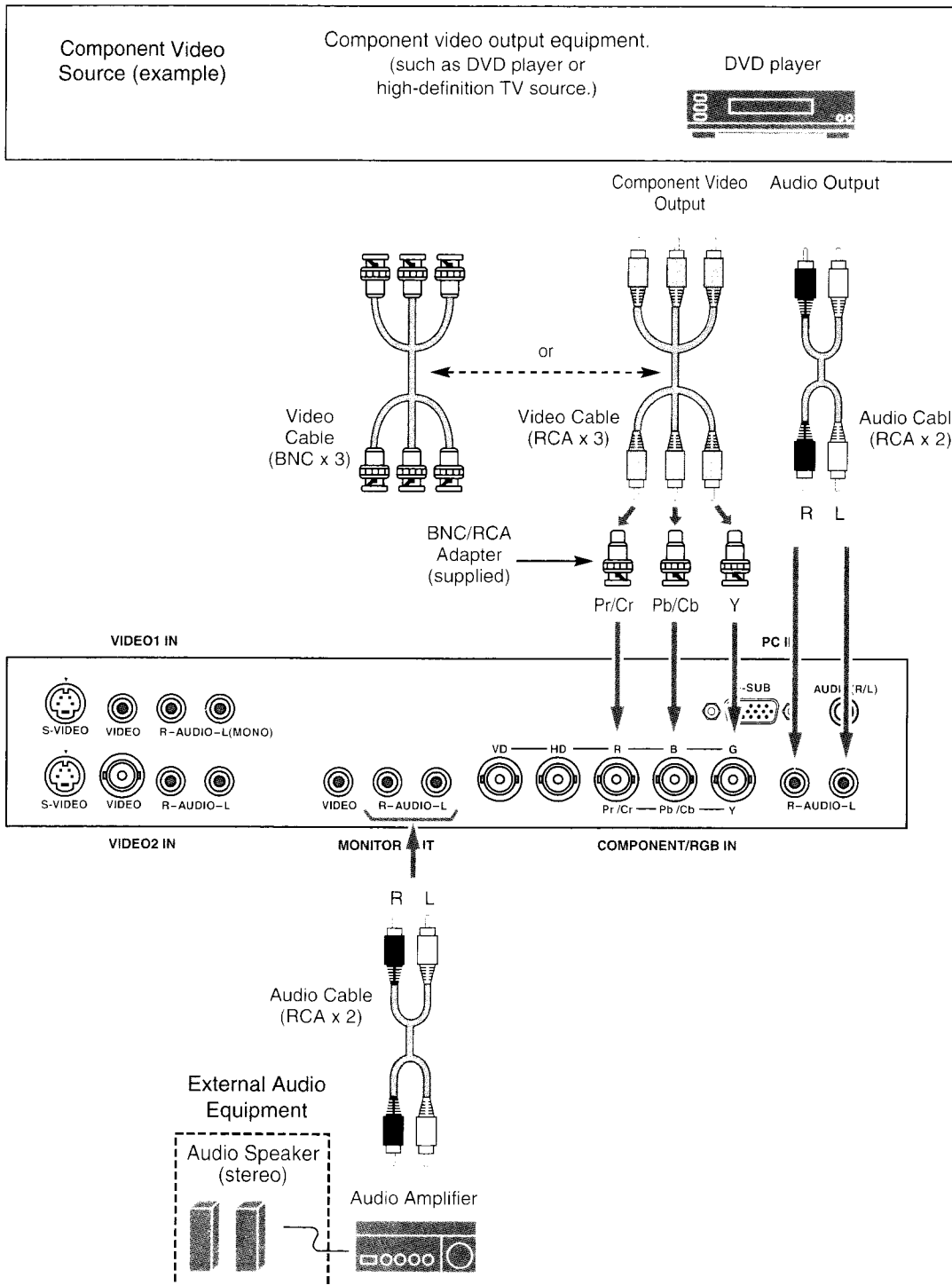

CONNECTING TO COMPUTER

Cables used for connection

- VGA Cable (HDB 15 pin)
 - Video Cable (BNC x 5) *
 - MAC Adapter (in the case of connecting Macintosh computer) *
 - Audio Cables (RCA x 2) or (Mini Plug - Mini Plug (R/L)) *
- *Those Cables and Adapter are not supplied with Plasma Monitor.



NOTE :

When connecting the cable, AC Power Cords of both Plasma Monitor and external equipment should be disconnected from AC outlet. Turn Plasma Monitor and peripheral equipment on before your computer is switched on.

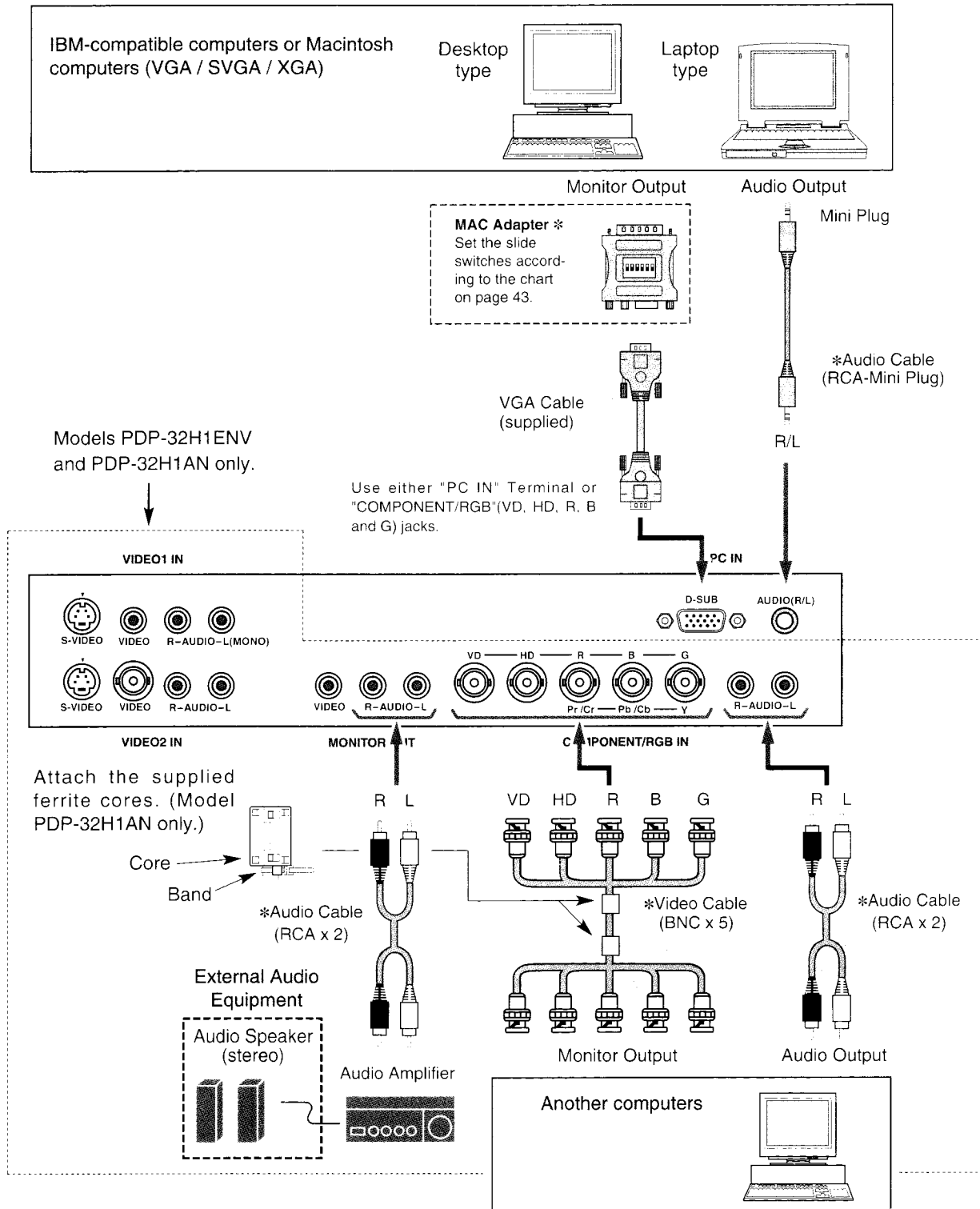

OPERATION OF REMOTE CONTROL

Remote Control Unit can be used as either Wired or Wireless.

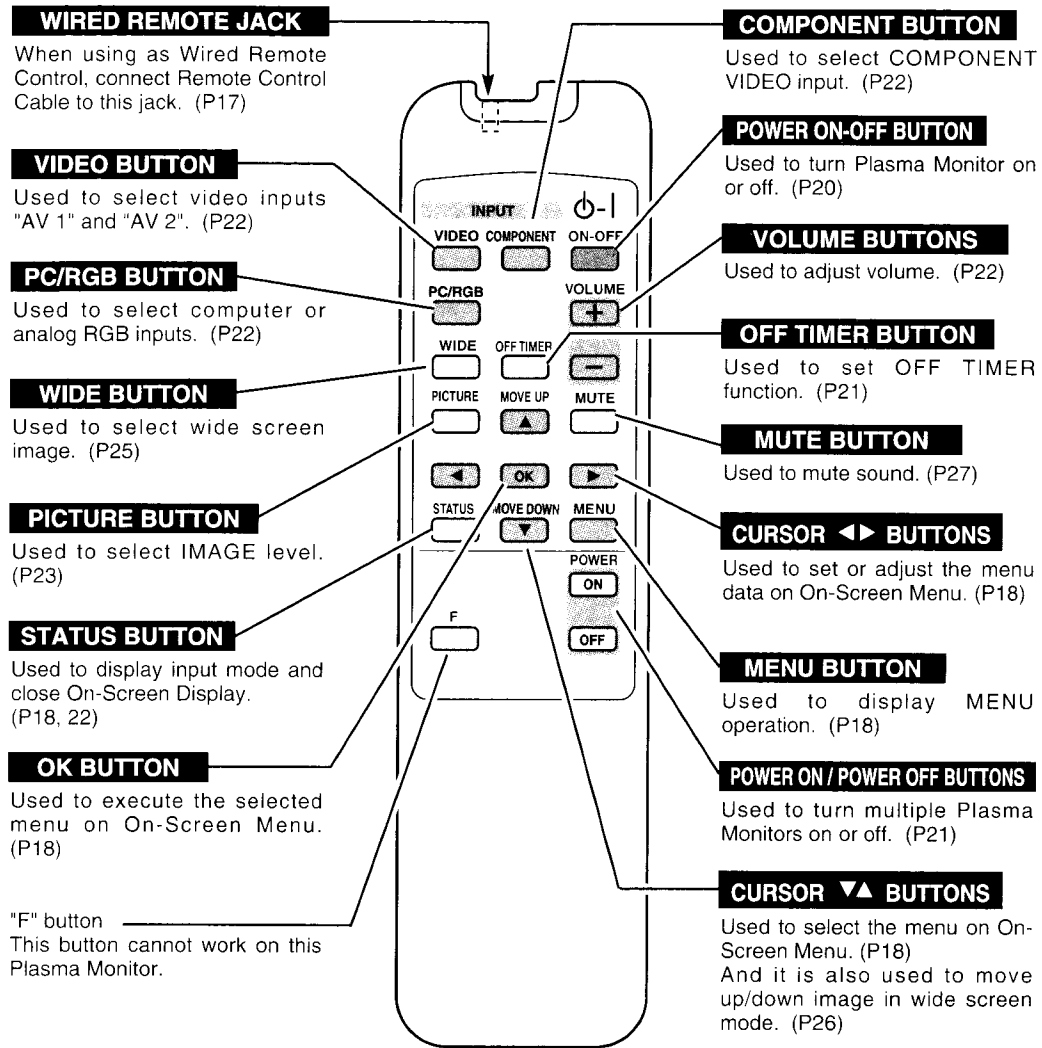

OPERATING RANGE

Point Remote Control toward Plasma Monitor (Remote Receiver) whenever pressing the buttons. Maximum operating range for Remote Control is about 16.4' (5m) and 60° in front of Plasma Monitor.

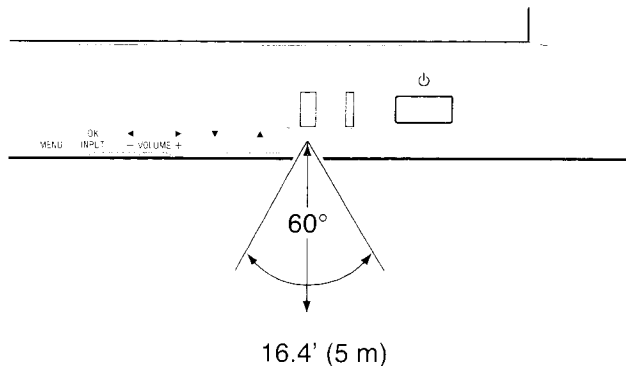

WIRED REMOTE CONTROL OPERATION

When using this Remote Control Unit as Wired Remote Control, Connect Remote Control Unit to R/C JACK with Remote Control Cable (supplied). Batteries installation is required when using as Wired Remote Control Unit.

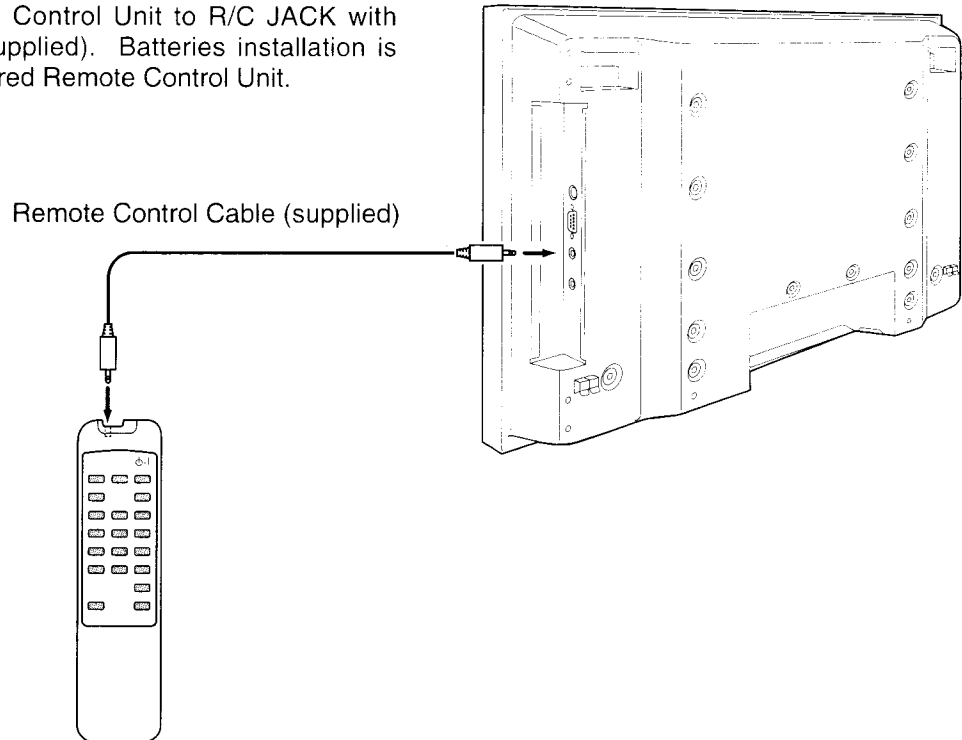

REMOTE CONTROL BATTERIES INSTALLATION

1 Remove the battery compartment lid.

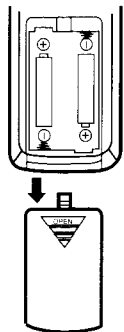

Press the lid downward and slide it.

2 Slide 2 batteries into the compartment.

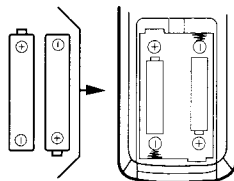

Two AA size batteries

For correct polarity (+ and -), be sure the battery terminals are in contact with pins in the compartment.

3 Replace the compartment lid.

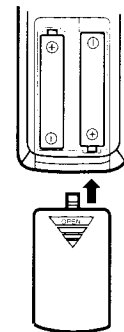

Slide the lid upward.



To insure safe operation, please observe the following precautions :

- Use (2) AA, UM3 or R06 type alkaline batteries.
- Replace two batteries at the same time.
- Do not use a new battery with a used battery.
- Avoid contact with water or liquid.
- Do not expose Remote Control Unit to moisture, or heat.
- Do not drop Remote Control Unit.
- If batteries have leaked on Remote Control Unit, carefully wipe the case clean and load new batteries.

OPERATING ON-SCREEN MENU

You can control and adjust this Plasma Monitor through ON-SCREEN MENU. Refer to the following pages to operate each adjustment on ON-SCREEN MENU.

BUTTONS OF ON-SCREEN MENU OPERATION

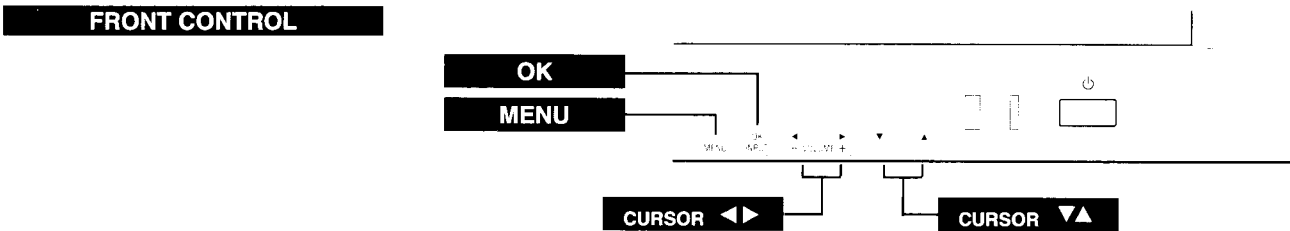
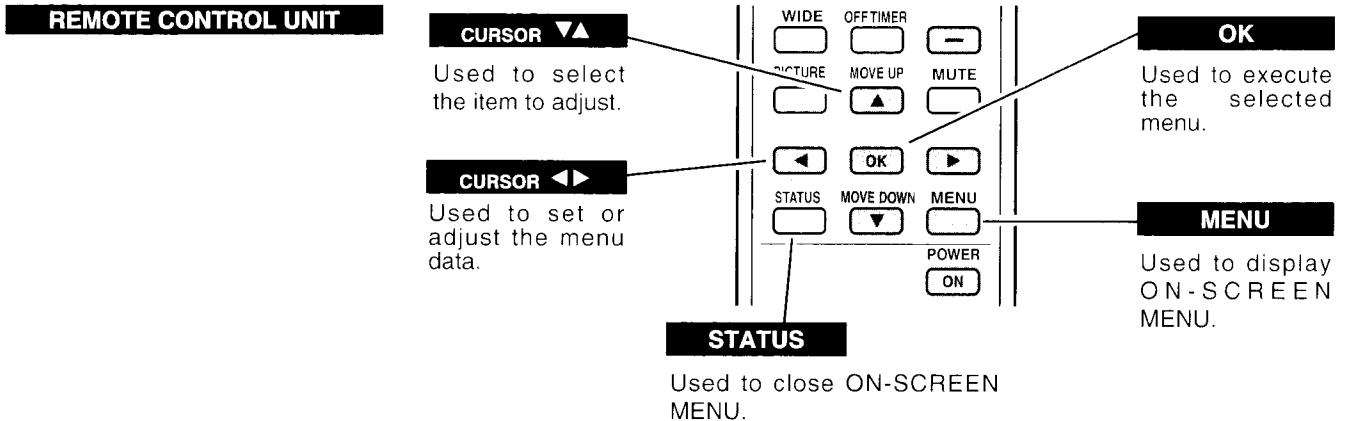

FLOW OF ON-SCREEN MENU OPERATION

- 1 Press MENU button and ON-SCREEN MENU will appear.
- 2 Press ▼▲ buttons to select the menu that you want to adjust, and then press OK button. The selected menu will appear.
- 3 Press ▼▲ buttons to select the item that you want to adjust.
- 4 Adjust the item by pressing ◀▶ buttons.
- 5 Press STATUS button to close ON-SCREEN MENU.

MENU

Contrast
Brightness
Color
Tint
Sharpness
Sound
Screen adjust
PC mode adjustment
Setup menu
Information
▲▼ : Select OK : OK
MENU : Return STATUS : Exit

"Sound" MENU (example)

Sound
Treble 0 ◀▶
Bass 0 ◀▶
Balance 0 ◀▶
BBE ◀▶ Off ▶
Surround ◀▶ Off ▶
▲▼ : Select ◀▶ : Adjust
MENU : Return STATUS : Exit

MENU LIST

Contrast
Brightness
Color
Tint
Sharpness
Sound
Screen adjust
PC mode adjustment
Setup menu
Information
▲▼ : Select OK : OK
MENU : Return STATUS : Exit

Contrast 63
▲▼ : Select ◀▶ : Adjust
MENU : Return STATUS : Exit

Contrast
(P24)

Brightness 31
▲▼ : Select ◀▶ : Adjust
MENU : Return STATUS : Exit

Brightness
(P24)

Color 31
▲▼ : Select ◀▶ : Adjust
MENU : Return STATUS : Exit

Color
(P24)

Tint 0
▲▼ : Select ◀▶ : Adjust
MENU : Return STATUS : Exit

Tint
(P24)

Sharpness 15
▲▼ : Select ◀▶ : Adjust
MENU : Return STATUS : Exit

Sharpness
(P24)

Sound
Treble 0
Bass 0
Balance 0
BBE Off
Surround Off
▲▼ : Select ◀▶ : Adjust
MENU : Return STATUS : Exit

"Sound" MENU
(P27)

Screen Adjust
Vertical 5
Horizontal 0
▲▼ : Select ◀▶ : Adjust
MENU : Return STATUS : Exit

"Screen Adjust"
MENU
(P26)

PC mode adjustment
Auto setup
Clock
Phase
Position
Power save
Information
▲▼ : Select OK : OK
MENU : Return STATUS : Exit

"PC mode adjustment"
MENU
(P29, 30)

Language English
Color system Auto
Screen saver On
Dynamic AI On
Child lock Off
ECO mode Off
Start mode Off
Color temperature Normal
No operation shut off timer Off
Video format Auto
Reset Setup
▲▼ : Select ◀▶ : Select
MENU : Return STATUS : Exit

"Setup menu"
(P33~36)

Information
Temperature OK
Cooling fan OK
Signal Video
480i/525i
MENU : Return STATUS : Exit

Information
(P39)

BASIC OPERATION

TURNING ON / OFF PLASMA MONITOR

- 1 Complete the peripheral connections (with Computer, VCR, etc.) before turning on Plasma Monitor. (Refer to "CONNECTING PLASMA MONITOR" on Pages 13-15 for connecting that equipment.)
- 2 Connect the Plasma Monitor's AC Power Cord into an AC outlet .
- 3 Press MAIN ON/OFF switch on Front Control of Plasma Monitor to turn ON. POWER indicator will light up(green) when Plasma Monitor is ON. Press MAIN ON/OFF switch again to turn OFF.

NOTE: When you are operating POWER ON-OFF button on Remote Control Unit, turn the Plasma Monitor ON with MAIN ON/OFF switch on the Plasma Monitor first. This is the master switch of the Plasma Monitor. Remote Control Unit does not work if this switch is OFF. POWER indicator lights in red when Plasma Monitor power is OFF(standby mode) with Remote Control Unit.

- 4 When MAIN ON/OFF switch on the Plasma Monitor is ON, you can turn power ON/OFF by POWER ON-OFF button on Remote Control Unit. When Plasma Monitor power is turned OFF with Remote Control Unit, POWER indicator lights in red (standby mode) .

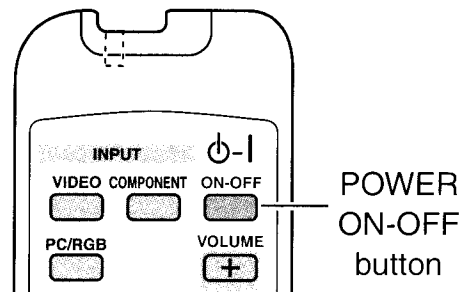
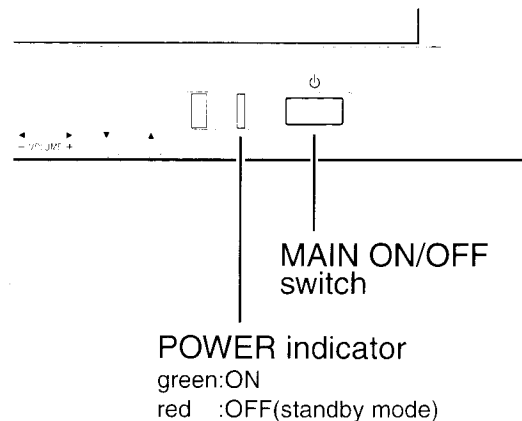

NOTE :

When "Power Save" function is set to "Yes" , Plasma Monitor detects signal interruption and turns off Plasma Monitor automatically. Refer to "Power Save" on page 30.

On-Screen display and On-Screen menu disappear after a short while for prevention of afterimage (ghost) on screen.

WHEN USE MULTIPLE MONITORS

When you use multiple Plasma Monitors, you can use POWER ON button and POWER OFF button on Remote Control Unit instead of the POWER ON-OFF button.

Press POWER ON button to turn Plasma Monitor ON so as not to affect another Plasma Monitor which may be already turned ON.

Press POWER OFF button to turn Plasma Monitor OFF (standby mode) so as not to affect another Plasma Monitor which may be already turned OFF (standby mode).

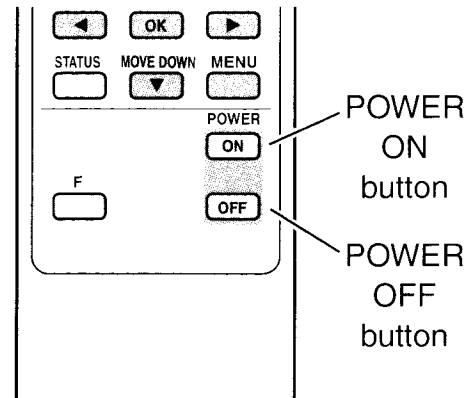

OFF TIMER

The OFF TIMER can be set to turn the power off after 30, 60, 90 or 120 minutes.

Pressing the OFF TIMER button on the Remote Control Unit until desired time is displayed.

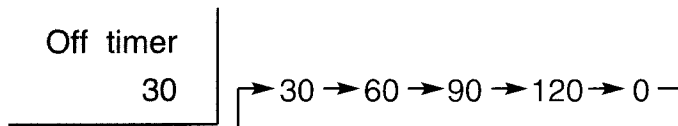

When remaining time reaches zero, "Off timer 0" appears for 10 seconds, then Plasma Monitor turns to OFF (standby mode).

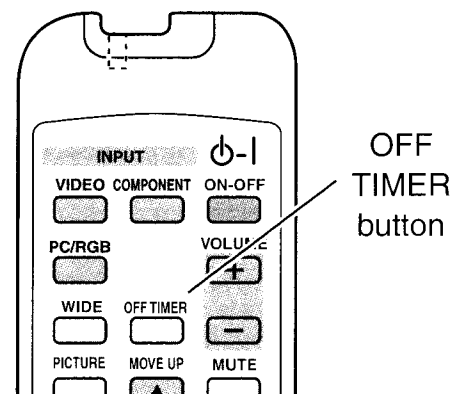

TO CHECK THE REMAINING TIME:

To check the remaining time of OFF TIMER set, press OFF TIMER button once. The remaining time displayed for few seconds.

When you select input signal, the remaining time is displayed below the input mode.

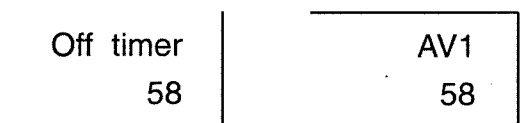

TO CANCEL THE OFF TIMER:

Pressing the OFF TIMER button until the time "0" is displayed.

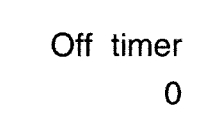

SELECTING INPUT SOURCE

VIDEO INPUT

Select either "AV1 (VIDEO1)" or "AV2 (VIDEO2)" by pressing VIDEO button on Remote Control Unit.
(Refer to "CONNECTING TO VIDEO EQUIPMENT" on Page 13.)

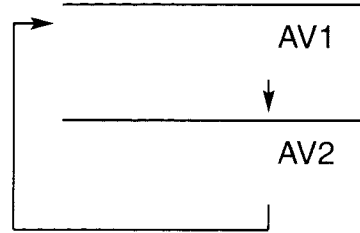

COMPONENT INPUT

Select "Component" by pressing COMPONENT button on Remote Control Unit.
(Refer to "CONNECTING TO COMPONENT VIDEO EQUIPMENT" on Page 14.)

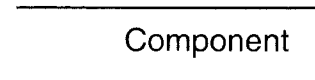

PC/RGB INPUT

Select "PC", "RGB1" or "RGB2" by pressing PC/RGB button on Remote Control Unit.
(Refer to "CONNECTING TO COMPUTER" on Page 15.)

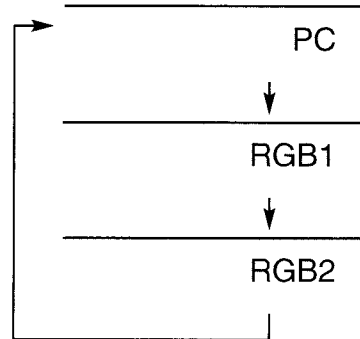

NOTE :

"RGB 1" input is compatible with PC input signals.

"RGB2" is provided for 21-PIN RGB video signals. When the connection of 21-PIN RGB video signals is on, "RGB2" should be selected.

When 21-PIN composite video signals are connected, connect to VIDEO1 or VIDEO2 INPUT JACKS and select AV1 or AV2 input mode. Composite signals connected to COMPONENT/RGB INPUT JACKS can not be displayed on the screen.

NOTE :

By pressing the STATUS button on Remote Control Unit, Video source and OFF TIMER's remaining time (if OFF TIMER is set) will be displayed for 5 seconds.

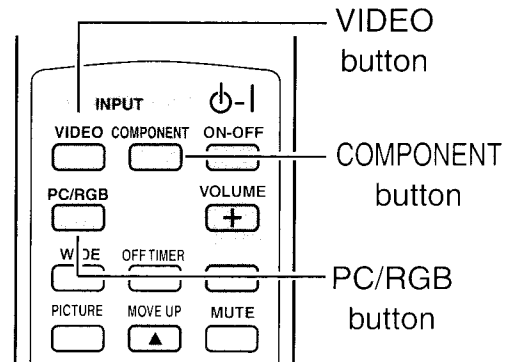

FRONT CONTROL OPERATION

Choose either input mode by pressing INPUT button on Plasma Monitor's Front Control.

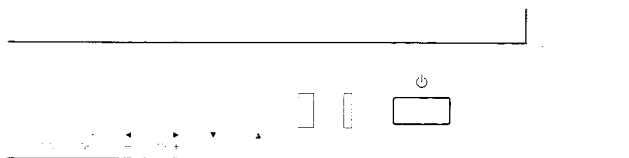

INPUT button

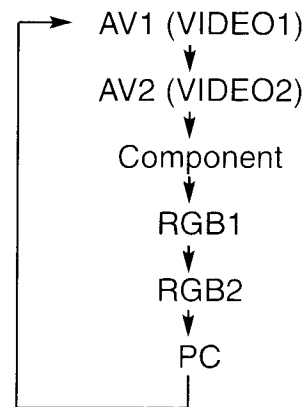

PICTURE IMAGE LEVEL SELECT

IN VIDEO/COMPONENT MODE

Select image level among Dynamic, Natural, Cinema and Memory by pressing PICTURE button on the Remote Control Unit.

Dynamic

High contrast picture level preset on this Plasma Monitor.

Natural

Normal picture level preset on this Plasma Monitor.

Cinema

Picture level adjusted for the picture with fine tone.

Memory

User preset picture adjustment in IMAGE ADJUST Menu (P24).

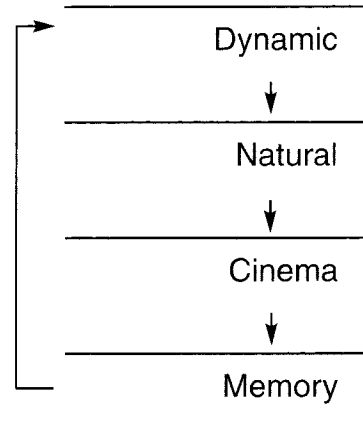

In Video / Component / RGB2 mode

IN PC/RGB MODE

Select image level among Graphic, Memory, Text and Standard by pressing PICTURE button on the Remote Control Unit.

Graphic

Select this mode when watching graphic image.

Standard

Normal picture level preset on this Plasma Monitor.

Text

Select this mode when watching text image.

Memory

User preset picture adjustment in IMAGE ADJUST Menu (P24).

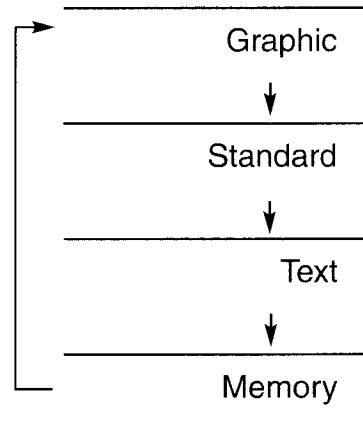

In PC / RGB1 mode

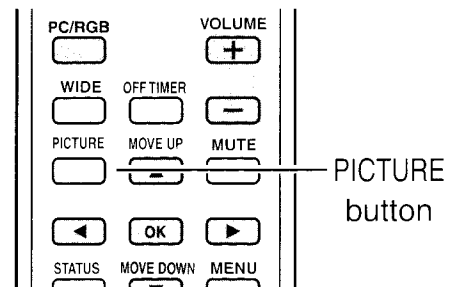
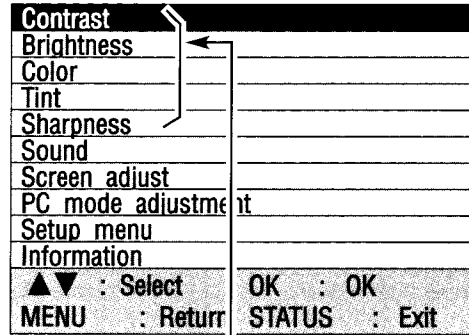

IMAGE LEVEL ADJUSTMENT

- 1 Press MENU button and ON-SCREEN MENU will appear.
- 2 Press ▼▲ buttons to select the item that you want to adjust, and then press OK button. The level of selected item is displayed.
- 3 Adjust each level by pressing ◀▶ buttons.

NOTE : ●Sharpness cannot be adjusted when the input mode is "PC" or "RGB1" except 480i, 575i and 1080i.
 ●The adjusted Video and Computer matters are memorized individually.

MENU



Select the item and then press OK button.

Contrast

Press ◀ button to decrease contrast, and ▶ button to increase contrast. (From 0 to 63.)

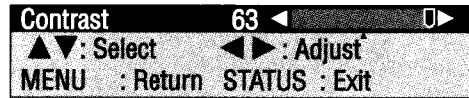

Brightness

Press ◀ button to adjust image darker, and ▶ button to adjust brighter. (From 0 to 63.)

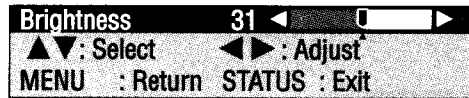

Color

Press ◀ button to lighter color, and ▶ button to darker color. (From 0 to 63.)

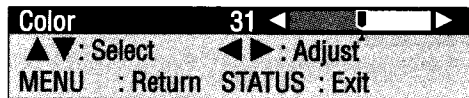

Tint

Press ◀ button or ▶ button to obtain proper color. (From -31 to 32.)

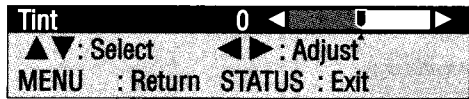

Sharpness

Press ◀ button to soften the image, and ▶ button to sharpen the image. (From 0 to 30.)

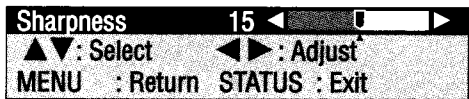

WIDE SCREEN OPERATIONS

With this function, you can select screen size.

SELECTING WIDE MODE

Select screen size among "Natural wide", "Zoom", "Zoom(Caption-IN)", "Full" and "Normal" by pressing WIDE button on the Remote Control Unit.

* "Zoom(Caption-IN)" mode cannot be selected at "PC" or "RGB1" input mode.

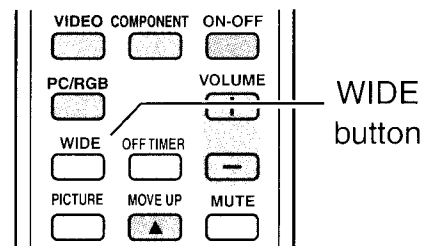
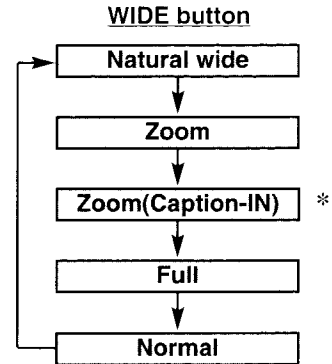

Natural wide

Provides image to fit width of screen by expanding both sides of image. This function is suitable to enjoy a normal video signal (4 : 3 aspect ratio) with wide video aspect ratio of 16 : 9 screen.

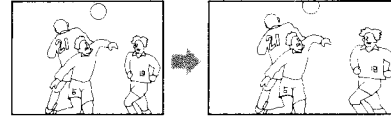

Zoom

Provides image to fit screen size (16 : 9 aspect ratio) by expanding image width and height uniformly. This function can be used for enjoying a letter box mode picture (4 : 3 aspect picture with black bar on top and bottom edges) with wide video aspect of 16 : 9 screen.

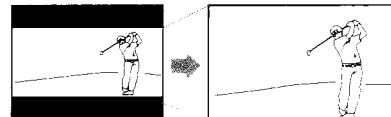

Zoom (Caption-IN)

Provides the image that is expanded as "Zoom" mode and moved up to show more image to include captions. This function can be used for enjoying a letter box picture with captions.

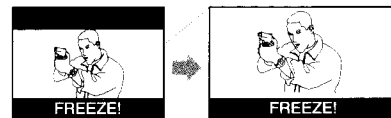

Full

Provides image to fit width of screen by expanding image width uniformly. This function can be used for enjoying a squeezed video signal with wide video aspect ratio of 16 : 9 screen. When your video equipment (such as DVD) has 16 : 9 output mode, select 16 : 9 and select Full on this SCREEN Menu to provide better quality.



Normal

Provides real 4 : 3 image on 16 : 9 screen.



BASIC OPERATION

UP/DOWN PICTURE

To move up/down the image vertically, press the MOVE UP / MOVE DOWN buttons.

NOTE :

- Up/down picture function can work only when the input signal mode is "AV1 (VIDEO1)", "AV2 (VIDEO2)" and "Component".
- Up/down picture function can work only when the image mode is "Natural wide", "Zoom" and "Zoom(Caption-IN)".

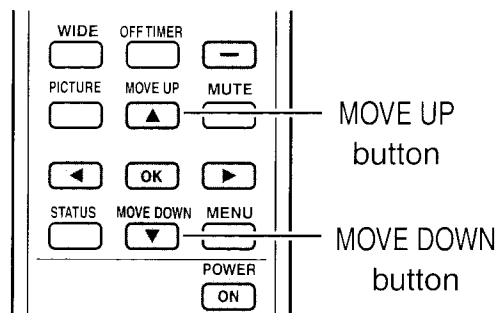

ADJUSTING WIDE IMAGE

- 1 Press MENU button and ON-SCREEN MENU will appear.
- 2 Press $\blacktriangledown/\blacktriangle$ buttons to select "Screen adjust" menu and then press OK button. "Screen Adjust" menu will appear.
- 3 Press $\blacktriangledown/\blacktriangle$ buttons to select "Vertical" or "Horizontal", and adjust image by pressing $\blacktriangleleft/\blacktriangleright$ buttons.

Adjustment data is memorized in each wide image mode.

NOTE : "Screen adjust" menu can be opened only when wide image mode is "Natural wide", "Zoom" and "Zoom(Caption-IN)".

"Screen Adjust" MENU

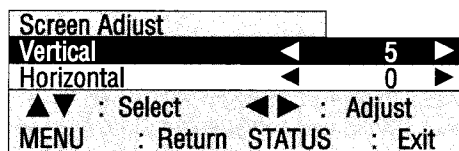

Vertical

Adjustment of height of image. (From -10 to 10.)

NOTE : "Vertical" can be adjusted only when wide image mode is "Natural wide", "Zoom" and "Zoom(Caption-IN)".

Horizontal

Adjustment of horizontal expand proportion on both sides of image. (From -10 to 10.)

NOTE : Horizontal can be adjusted only when wide image mode is "Natural wide".

SOUND ADJUSTMENT

VOLUME

Press VOLUME (+/-) button(s) on Remote Control Unit or Front Control to adjust volume. Volume dialog box appears on the screen for a few seconds.

(+) button to increase volume, and (-) button decreasing.

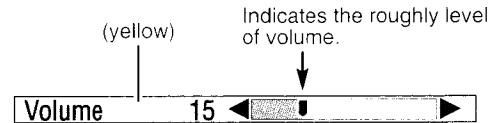

MUTE

Press MUTE button on Remote Control Unit to cut off sound. To restore sound to its previous level, press MUTE button again or press Volume (+/-) button(s).

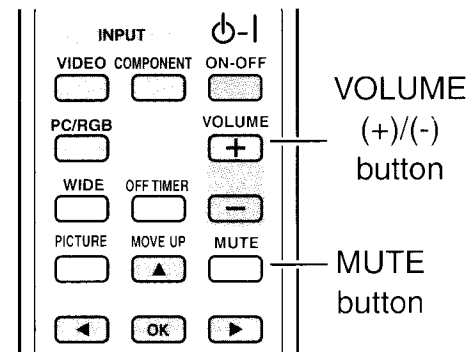

SOUND ADJUSTMENT

- 1 Press MENU button and ON-SCREEN MENU will appear.
- 2 Press ▼▲ buttons to select "Sound" menu and then press OK button. "Sound" menu will appear.
- 3 Press ▼▲ buttons to select the item that you want to adjust, and make adjustment by pressing ◀▶ buttons.

Treble

Press ◀ button to decrease high frequency sound, and ▶ button to increase high frequency sound. (From -32 to 32.)

Bass

Press ◀ button to decrease low frequency sound, and ▶ button to increase low frequency sound. (From -32 to 32.)

Balance

Adjusts the balance of the left and right channels. (From -32 to 32.)

BBE

Set "On" to provide "BBE-ON" sound, and set "Bass" to provide "BBE Mach 3 Bass-ON" sound.

Surround

Set "On" to provide a surround (3 dimensional) sound.

"Sound" MENU

Sound		
Treble	0	◀▶
Bass	0	◀▶
Balance	0	◀▶
BBE		◀ Off ▶
Surround		◀ Off ▶
▲▼ : Select ◀▶ : Adjust		
MENU : Return STATUS : Exit		

BBE® BBE
Mach3Bass

licensed by BBE Sound, Inc. under USP4638258 and 482866. BBE and BBE symbol are registered trademarks of BBE Sound.

COMPUTER MODE

SELECTING INPUT SOURCE

REMOTE CONTROL OPERATION

Select "PC" or "RGB1" by pressing PC/RGB button on Remote Control Unit.

FRONT CONTROL OPERATION

Select "PC" or "RGB1" by pressing INPUT button on Front Control.

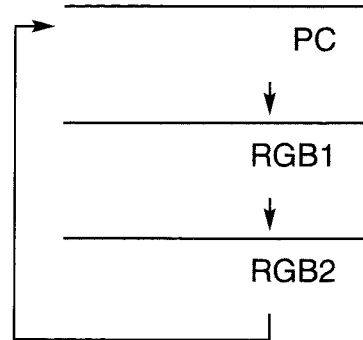

NOTE :

"RGB2" is used for RGB Video signals from 21-PIN connector. (Refer to "CONNECTING TO VIDEO EQUIPMENT" on page 13.)

SELECTING COMPUTER SYSTEM

This Plasma Monitor automatically tunes to most different types of computers based on VGA, SVGA or XGA (refer to "COMPATIBLE COMPUTER SPECIFICATIONS" on page 31). When selecting Computer, this Plasma Monitor automatically tunes to incoming signal and display proper image without any special setting. (Some computers need setting manually.)

If the Monitor cannot be tuned, follow in message will be displayed.

Out of scan range

When Plasma Monitor cannot recognize connected signal that PC system provides in the message "Out of scan range" is displayed on screen.

No signal

There is no signal input from computer. Make sure the connection of computer and Plasma Monitor is set correctly.

PC ADJUSTMENT

PC MODE ADJUSTMENT

"PC mode adjustment" menu is provided to adjust "Auto setup", "Clock", "Phase", "Position", "Power save" and "Information" to conform to your computer. These function can be operated as follows.

- 1 Press MENU button and ON-SCREEN MENU will appear.
- 2 Press ▼▲ buttons to select "PC mode adjustment" menu and then press OK button. "PC mode adjustment" menu will appear.
- 3 Press ▼▲ buttons to select the item that you want to adjust, and then press OK button. The selected item will appear.
- 4 Adjust each level by pressing ◀▶ buttons.

"PC mode adjustment" MENU

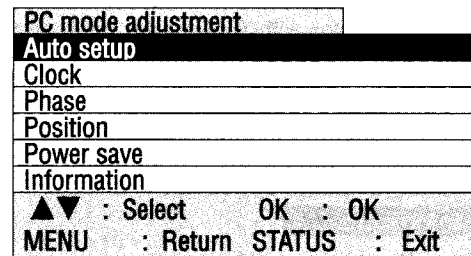

Auto setup

"Auto setup" function is provided to automatically adjust "Clock", "Phase" and "Position" to conform to your computer. "Auto setup" started by pressing the ▶ button, and the message "Now adjusting" will be displayed. Display returns to previous menu when adjustment is completed.

NOTE :

- In the following cases, the Plasma Monitor may not adjust itself with the "Auto setup" function.
 - 1) If the picture is not displayed fully on the screen.
 - 2) When a contrast pictures, such as an outdoor scene, is displayed on the screen.
- It depends on signal and computer's configuration, "Auto setup" function cannot be operated properly. In this case, adjust "Clock", "Phase" and "Position" manually.

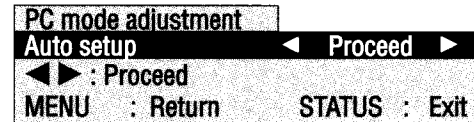

Clock

Adjust when Vertical noise lines are observed. (Horizontal width will be changed by adjustment.) Adjust with ◀▶ buttons.

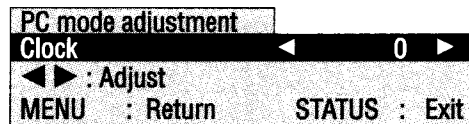

Phase

Adjust when Horizontal noise lines are observed. Adjust with ◀▶ buttons.

NOTE : This adjustment may be needed when a image becomes unclear or flickering.

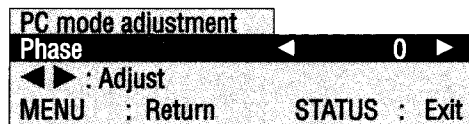

Position

Adjusts the screen position. Adjust with ▼▲ ◀▶ buttons.

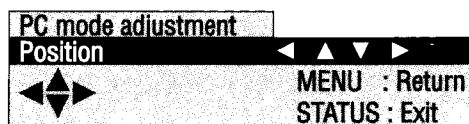

COMPUTER MODE

Power save

Enable or disable Power save function.
Enable Power save by choosing "Yes" with ◀▶ buttons.

NOTE :

- The Power save function automatically reduces the Plasma Monitor's power consumption if the computer is not operated for a certain period of time. This function can be used when using the Plasma Monitor with a computer conforming to the VESA DPMS standard.
- To activate power save, computer setup is also needed. (Refer to Computer Operation manual.)

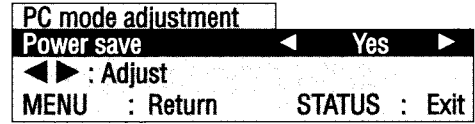

Information

Indicate the input signal information.

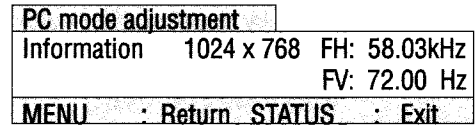

COMPATIBLE COMPUTER SPECIFICATIONS

Basically this Plasma Monitor can accept the signal from all computers with the V, H-Frequency mentioned below and less than 100 MHz of Dot Clock.

SYSTEM MODE	RESOLUTION	H-Freq. (kHz)	V-Freq. (Hz)
VGA	640 x 480	31.47	59.88
VGA	640 x 400	31.47	70.09
VGA	640 x 480	37.86	74.38
VGA	640 x 480	37.86	72.81
MAC LC13	640 x 480	34.97	66.60
MAC 13	640 x 480	35.00	66.67
RGB	—————	15.625	50.00 (Interlace)
RGB	—————	15.734	60.00 (Interlace)
SVGA	800 x 600	35.16	56.25
SVGA	800 x 600	37.88	60.32
SVGA	800 x 600	46.88	75.00
SVGA	800 x 600	53.67	85.06
SVGA	800 x 600	48.08	72.19
SVGA	800 x 600	37.90	61.03
SVGA	800 x 600	34.50	55.38
SVGA	800 x 600	38.00	60.51
SVGA	800 x 600	38.60	60.31
SVGA	800 x 600	32.70	51.09
MAC 16	832 x 624	49.72	74.55
MAC 19	1024 x 768	60.24	75.08
MAC 1960	1024 x 768	48.22	59.31
XGA	1024 x 768	48.36	60.00
XGA	1024 x 768	60.02	75.03
XGA	1024 x 768	60.31	74.92
XGA	1024 x 768	48.50	60.02
XGA	1024 x 768	44.00	54.58
XGA	1024 x 768	63.48	79.35
XGA	1024 x 768	62.04	77.07
XGA	1024 x 768	46.90	58.20
XGA	1024 x 768	47.00	58.30
XGA	1024 x 768	58.03	72.00
720p(HDTV)	—————	45.00	60.00
1035i(HDTV)	—————	33.75	60.00 (Interlace)
1080i(HDTV)	—————	33.75	60.00 (Interlace)

NOTE :

The image data from connected computer is modified to fit the Plasma Monitor's screen size. Specifications are subject to change without notice.

SELECTING INPUT SOURCE

VIDEO INPUT

Select either "AV1 (VIDEO1)" or "AV2 (VIDEO2)" by pressing VIDEO button on Remote Control Unit.

When the connection of 21-PIN video signals is on, "RGB2" should be selected by pressing PC/RGB button on Remote Control Unit.

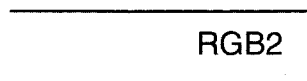
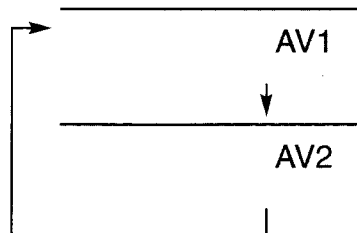

COMPONENT INPUT

Select "Component" by pressing COMPONENT button on Remote Control Unit.

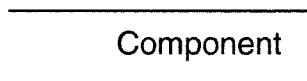

FRONT CONTROL OPERATION

Select "AV1 (VIDEO1)", "AV2 (VIDEO2)", "RGB2" or "Component" by pressing INPUT button on Front Controls.

SELECTING VIDEO SYSTEM

VIDEO JACK OR S-VIDEO JACK

- 1 Press MENU button and ON-SCREEN MENU will appear.
- 2 Press ▼▲ buttons to select "Setup menu" and then press OK button. "Setup menu" will appear.
- 3 Press ▼▲ buttons to select "Color system".
- 4 Press ◀▶ buttons and select Color system.

Auto

Plasma Monitor automatically detects incoming Color system, and adjusts itself to optimize its performance.

PAL / SECAM / NTSC / NTSC4.43 / PAL-M / PAL-N

If Plasma Monitor cannot reproduce proper video image, it is necessary to select a specific broadcast signal format among PAL, SECAM, NTSC, NTSC 4.43, PAL-M, and PAL-N.

"Setup menu"

Language	◀ English ▶
Color system	Auto
Screen saver	On
Dynamic AI	On
Child lock	Off
ECO mode	Off
Start mode	Off
Color temperature	Normal
No operation shut off timer	Off
Video format	Auto
Reset	Setup
▲▼ : Select	◀▶ : Select
MENU : Return	STATUS : Exit

Color system

- Auto
- NTSC3.58
- NTSC4.43
- PAL
- SECAM
- PAL-M
- PAL-N

Y, Pb/Cb, Pr/Cr JACKS

- 1 Press MENU button and ON-SCREEN MENU will appear.
- 2 Press ▼▲ buttons to select "Setup menu" and then press OK button. "Setup menu" will appear.
- 3 Press ▼▲ buttons to select "Video format".
- 4 Press ◀▶ buttons and select Video format.

Auto

Plasma Monitor automatically detects incoming Video signal, and adjusts itself to optimize its performance.

COMPONENT VIDEO SIGNAL FORMAT

If Plasma Monitor cannot reproduce proper video image, it is necessary to select a specific component video signal format among 480i, 575i, 480p, 720p, 1035i and 1080i.

"Setup menu"

Language	◀ English ▶
Color system	Auto
Screen saver	On
Dynamic AI	On
Child lock	Off
ECO mode	Off
Start mode	Off
Color temperature	Normal
No operation shut off timer	Off
Video format	Auto
Reset	Setup
▲▼ : Select	◀▶ : Select
MENU : Return	STATUS : Exit

Video format

- Auto
- 480i
- 575i
- 480p
- 720p
- 1035i
- 1080i

SCREEN SAVER FUNCTION

Displaying a still picture (non-movement) on the screen for a long time cause a burning image on the screen. To neutralize the remaining image, Screen Saver function (3 modes) is provided in the Monitor. Use the function conveniently.

SELECTING SCREEN SAVER

- 1 Press MENU button and ON-SCREEN MENU will appear.
- 2 Press ▼▲ buttons to select "Setup menu" and then press OK button. "Setup menu" will appear.
- 3 Press ▼▲ buttons to select "Screen saver" and then press ◀▶ buttons. "Screen saver" menu will appear.
- 4 Press ▼▲ buttons to choose either the screen saver "Pic rotation" or "White pattern". And then press ◀▶ buttons. The chosen screen saver will turn ON.

"Screen saver" MENU

Screen saver	
Pic rotation	◀ On ▶
Cycle time	◀ 30 Min ▶
Dot	◀ 20 ▶
White pattern	◀ Off ▶
Interval	◀ 60 Min ▶
Display time	◀ 10 Min ▶
Side bar	◀ Off ▶
▲▼ : Select	◀▶ : Select
MENU : Return	STATUS : Exit

NOTE : Priority is given to the "Power save" function when the "Power save" function is set as "yes".

PICTURE ROTATION

The screen saver "Pic rotation" automatically changes display position.

- 1 In the "Screen saver" menu ("Pic rotation-On"), press ▼▲ buttons to select "Cycle time", and press ◀▶ buttons to select desired cycle time.
Cycle time : 15 Min / 30 Min / 60 Min
- 2 Press ▼▲ buttons to select "Dot", and press ◀▶ buttons to select moving distance.
Dot: 5 / 10 / 20 (dots)

WHITE PATTERN

The screen saver "White pattern" displays white pattern.

- 1 In the "Screen saver" menu ("White pattern-On"), press ▼▲ buttons to select "Interval (time)", and press ◀▶ buttons to select desired interval time.
Interval (time) : 30 Min / 60 Min / 90 Min / 0 Min

When the interval time is set at "0", the white pattern displayed all the time.

- 2 Press ▼▲ buttons to select "Display time", and press ◀▶ buttons to select display time (White screen display time).
Display time : 5 Min / 10 Min

SIDE BAR

When 4 : 3 image of screen saver is displayed for a long period of time, the 4 : 3 image and black bars on side will remain as the burning image. "Side bar" function changes the black bars into gray and the burning image can be neutralized.

In the "Screen saver" menu press ▼▲ buttons to select "Side bar", and press ◀▶ buttons to select "On" or "Off".

NOTE : This function works only when 4 : 3 signal is provided.

SETTING MENU

- 1 Press MENU button and ON-SCREEN MENU will appear.
- 2 Press ▼▲ buttons to select "Setup menu" and then press OK button. "Setup menu" will appear.
- 3 Press ▼▲ buttons to select the item that you want to setup, and setup the selected item by pressing ◀▶ buttons.

Language

Select language by pressing ◀▶ buttons among English, French, German, Italian, Spanish, Chinese and Japanese.

Color system

Refer to "SELECTING VIDEO SYSTEM". (P33)

Screen Saver

Refer to "SCREEN SAVER FUNCTION". (P34)

Dynamic AI

Enable or disable the "Dynamic AI (Automatic Image control)" function.

Child lock

This function is used to lock current control settings, so that they cannot be inadvertently changed. With "Child lock-On", Plasma Monitor's front control buttons (except MAIN ON/OFF switch and MENU button) will be locked. Locked items in the menu will be displayed in gray.

Remote Control buttons can be operated under "Child lock-On".

ECO mode

This function is used to reduce the power consumption of the Plasma Monitor. Press ◀▶ buttons to select "ECO1" or "ECO2". "ECO1" is less power reduction of "ECO2". In the "ECO1" or "ECO2" mode, screen brightness goes down, and "E" will be appeared when you select image level.

Start mode

This function is used for selecting input mode at Plasma Monitor power ON. Select start mode "AV1 (VIDEO1)", "AV2 (VIDEO2)", "Component" or "PC" with ◀▶ buttons which you wish to select input at power ON. When "Off" mode is selected, last selected input mode is observed when power is ON.

"Setup menu"

Language	◀ English ▶
Color system	◀ Auto ▶
Screen saver	◀ On ▶
Dynamic AI	◀ On ▶
Child lock	◀ Off ▶
ECO mode	◀ Off ▶
Start mode	◀ Off ▶
Color temperature	◀ Normal ▶
No operation shut off timer	◀ Off ▶
Video format	◀ Auto ▶
Reset	◀ Setup ▶
▲▼ : Select	◀▶ : Select
MENU : Return	STATUS : Exit

Dynamic

E

ECO mode indication

Color temperature

This function is used for selecting color temperature. Select "Normal", "Cool" or "Warm" with ◀▶ buttons which you wish to select.

No operation shut off timer

This function turns off Plasma Monitor's power automatically, when there is no operation of Remote Control or Front Control for 3 hours. When "On" mode selected, if there is no operation for 3 hours, the message "No operation : Power off" will be displayed for about 1 minute, and Plasma Monitor's power will be turned off automatically.

Video Format

Refer to "SELECTING VIDEO SYSTEM". (P33)

Reset

All adjustments in the memory can be reset to factory-settings.

- 1) Press ▶ button . Reset menu will appear.
- 2) Press ◀▶ buttons to select "On" and then press OK button. All adjustments in the memory is reset to factory-settings.

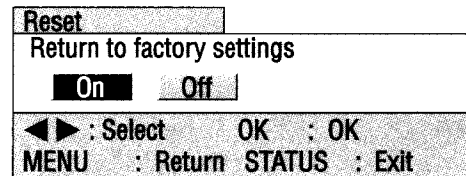

CLEANING THE PLASMA MONITOR

Be sure to disconnect the AC Power cord from AC outlet before cleaning the Plasma Monitor.
Clean your Plasma Monitor as follows ;

- Gently wipe the screen and cabinet with dry soft cloth.
- The screen is likely to be damaged if it is not maintained properly. Do not use hard objects like a hard cloth or paper. Do not use solvents or abrasives.

CAUTION :

Do not use benzene, thinner, or any volatile substances to clean the Plasma Monitor. These chemicals may damage the cabinet finish.

TROUBLESHOOTING

Before calling your dealer or service center for assistance, check the matters below once again.

1. Make sure you have connected Plasma Monitor to your equipment as described in the section "CONNECTING PLASMA MONITOR" on pages 13 ~ 15.
2. Check cable connection. Verify that all computer, video and power cords are properly connected.
3. Verify that all power is switched on.
4. If Plasma Monitor still does not produce an image, re-start the computer.
5. If the image still does not appear, unplug Plasma Monitor from the computer and check the computer monitor's display. The problem may be with your graphics controller rather than with Plasma Monitor. (When you reconnect Plasma Monitor, remember to turn the computer and monitor off before you power up Plasma Monitor. Power the equipment back on in order of : Plasma Monitor and computer.)
6. If the problem still exists, check the following chart.

Problem:	Try these Solutions
No power.	<ul style="list-style-type: none"> ● Plug Plasma Monitor into the AC outlet. ● Check MAIN ON / OFF Switch is in the ON position. ● Within 4 seconds after turning off Plasma Monitor, the Plasma Monitor cannot be turned on again. ● Check POWER Indicator. If this indicator flashes, Plasma Monitor has any trouble. (P39)
Remote Control Unit does not work.	<ul style="list-style-type: none"> ● Check the batteries. ● Make sure nothing is between the Remote Receiver and the Remote Control Unit. ● Make sure you are not too far from Plasma Monitor when using the Remote Control Unit. Maximum operating range is 16.4' (5m). ● Is direct sunlight or strong artificial light shining on the Plasma Monitor's Infrared Remote Receiver? Eliminate the light by closing curtains, pointing the light in a different direction, etc.
No image.	<ul style="list-style-type: none"> ● Check the connection between the computer or video equipment and Plasma Monitor. ● When turning Plasma Monitor on, it takes a few seconds to display the image. ● Check the system that you select is corresponding with the computer or the video equipment. ● Make sure the temperature is not out of the Operating Temperature (0°C ~ 40°C). ● Is the Power Save function in the standby or off mode? (In PC mode) Operate the computer (move the mouse, etc.).
No sound.	<ul style="list-style-type: none"> ● Check speaker cable connection . ● Check audio cable connection from audio input source. ● Adjust the audio source. ● Press VOLUME (+) button. ● Press MUTE button.
The message "Warning! ..." is displayed.	<ul style="list-style-type: none"> ● When the message "Warning! Internal fan is in trouble, not working properly." is displayed, the internal cooling fan has trouble. (Refer to P38) ● When the message "Warning! Internal temperature is too high." is displayed, the internal temperature of Plasma monitor exceeds the normal temperature. After displaying this message for 10 seconds, Plasma Monitor will be turned off automatically. (Refer to P39)
Afterimages (ghosts) appear.	<ul style="list-style-type: none"> ● Do not display one non-movement image on the screen for a long period of time. Otherwise, an afterimages or ghosts may appear on a part of the panel. ● Use the Screen Saver function. (Refer to P34) ● Display a moving picture. Afterimage may be disappeared gradually.

Problem:	Try these Solution
There are tiny black points and/or bright points on the PDP.	<ul style="list-style-type: none">● There may be some tiny black points and/or bright points on PDP (Plasma Display Panel). These points are normal.
The POWER indicator is flashing. (No power)	<ul style="list-style-type: none">● The Plasma Monitor has trouble, and Self Diagnose function activates. (Refer to P39)

WARNING :

High voltages are used to operate this Plasma Monitor. Do not attempt to open the cabinet.

If the problem still persists after following all operating instructions, contact the sales dealer where you purchased Plasma Monitor or the service center. Give the model number and explain about the problem in detail. We will advise you how to obtain service.

FUNCTIONS OF PRODUCT SAFETY FEATURES

For protecting product safety, protection features provided inside the Plasma Monitor. Each feature operating as follows ;

COOLING FAN

When the temperature of inside the Plasma Monitor becomes high, the cooling fans start operating automatically and cooling down the Plasma Monitor. Fan's running speed is changed according to the temperature of inside the Plasma Monitor. When the Plasma Monitor has cooled down, fans stop operating.

When the message "Warning! Internal fan is in trouble, not working properly." is displayed.

When above message is displayed, the internal cooling fan has trouble. This message is displayed for 10 seconds in every 10 minutes. If this message is displayed often, contact sales dealer where you purchased the Plasma Monitor or the service center.

INTERNAL TEMPERATURE MONITOR

This function activates due to the temperature inside Plasma Monitor. When the temperature inside Plasma Monitor exceeds the normal, after displaying a message, Plasma Monitor will be turned off automatically.

When the message "Warning! Internal temperature is too high." is displayed.

When this message is displayed, the internal temperature of Plasma monitor exceeds normal. After displaying this message for 10 seconds, Plasma Monitor will be turned off automatically. When Plasma Monitor cooling down to normal, Plasma Monitor can be turned on again by pressing POWER button. If this message is displayed often, contact sales dealer where you purchased the Plasma Monitor or the service center.

AUTO POWER OFF

When a trouble is detected in the Plasma Monitor, the protection function works and turn the Plasma Monitor OFF automatically. When the Plasma Monitor is turned OFF with this function, the POWER indicator flashes and Plasma Monitor's power cannot be turned ON.

Disconnect Power cord and contact sales dealer where you purchased the Plasma Monitor or the service center.

To turn the Plasma Monitor again for checking ;

1) Disconnect Power cord from AC outlet and plug it on again.

2) Press POWER button and attempt turn ON Plasma Monitor.

If Plasma Monitor is not turned ON, disconnect Power cord and contact to service center.

INFORMATION MENU

The "information" menu displays a condition of internal temperature, a condition of cooling fan, and informations of input video signal .

1 Press MENU button and ON-SCREEN MENU will appear.

2 Press ▼▲ button to select "Information" menu and then press OK button. "Information" menu will appear.

When "Temperature" or "Cooling fan" is displayed "NG", turn off Plasma Monitor and contact sales dealer where you purchased the Plasma Monitor or the service center.

"Information" MENU

Information	
Temperature	OK
Cooling fan	OK
Signal	Video 480i/525i
MENU : Return STATUS : Exit	

TECHNICAL SPECIFICATIONS

Screen Diagonal	32V
Product name	Multimedia Plasma Monitor
Panel type	Plasma Display Panel (16 x 9)
Display area	716 mm (W) x 399 mm (H)
Resolution / Color	852 x 1024 pixels / 16,770,000 colors
Viewing Angle	160° (Vertical / Horizontal)
Color System	PAL / SECAM / NTSC / NTSC4.43 / PAL-M / PAL-N
PC Interface	D-SUB, RGB
Capability	Up to XGA
Plug & Play	VESA DDC2B
Power Management	VESA DPMS
Audio Amp	8W + 8W (8 Ω)
Terminals	
AC IN	3PIN
VIDEO1 IN *	VIDEO / S-VIDEO (RCA type / Mini DIN 4pin type) AUDIO R and L (MONO) (RCA type)
VIDEO2 IN *	VIDEO / S-VIDEO (BNC type / Mini DIN 4pin type) AUDIO R and L (RCA type)
COMPONENT/RGB IN *	Y, Pb/Cb, Pr/Cr / R, G, B, VD, HD (BNC type) AUDIO R and L (RCA type)
PC IN	RGB (D-SUB 15pin) AUDIO R / L (Stereo Mini jack)
RS232C IN	RS232C (D-SUB 9pin)
WIRED RC IN	Stereo Mini Jack
MONITOR OUT *	VIDEO (RCA type) AUDIO R and L (RCA type)
HEADPHONE OUT	Stereo Mini Jack
EXT. SP OUT	R and L, 8W (8 Ω), Push type
POWER SUPPLY	AC 100 - 120V 50/60 Hz, AC 200 - 240V 50/60 Hz (PDP-32H1AN) AC 200 - 240V 50/60 Hz (PDP-32H1ENV, PDP-32H1EN)
DIMENSION (W x H x D)	829 x 517 x 122 mm (32.6" x 20.4" x 4.8") (Plasma Monitor only)
WEIGHT (NET)	25 kg (55.1 lbs) (Plasma Monitor only)
Regulations	FCC CLASS-B, UL, CE
Environmental Considerations	
Operating Temperature	0°C ~ 40°C (32°F ~ 104°F)
Humidity	20 ~ 80%
Altitude	0 ~ 2,000 m (0 ~ 6,560 ft)
Storage Temperature	-10°C ~ 50°C (14°F ~ 122°F)
Humidity	20 ~ 80 %
Altitude	0 ~ 3,000 m (0 ~ 9,840 ft)
Accessories	Owner's Manual AC Power Cord Wired/Wireless Remote Control Transmitter and Batteries PC Cable (D-SUB) Remote Control Cable BNC / RCA Adapters (x5) Ferrite cores

* Those terminals are not provided on model PDP-32H1EN.

● Specifications are subject to change without notice.

MEASUREMENT

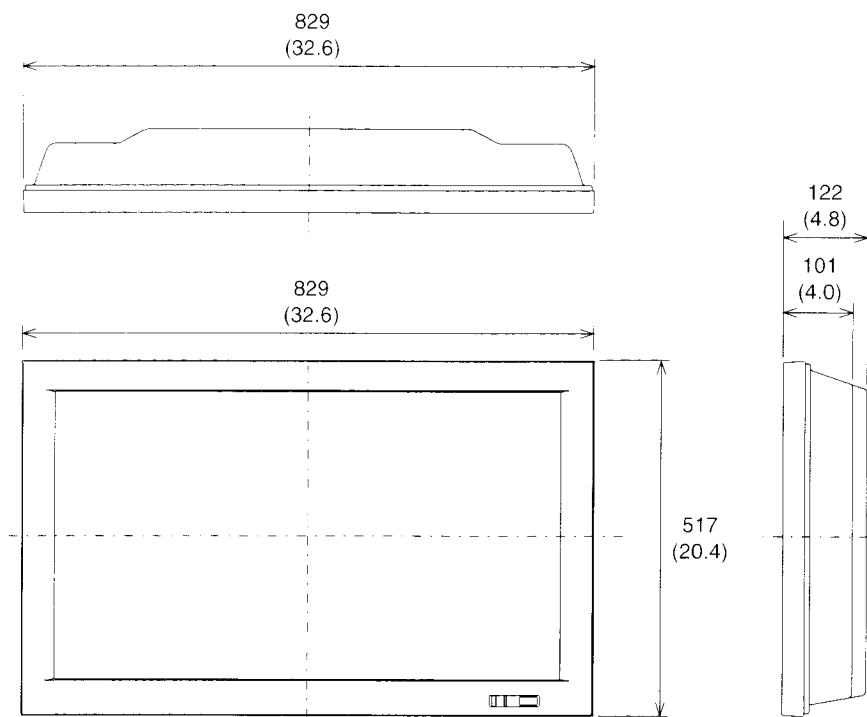

Size in mm (inch)

OPTIONS

The products listed below are optionally supplied.
When ordering these products, give name and Type No. to sales dealer.

Speaker unit	KA-SX-32H (R and L)
Table top stand	KA-TD-H10S
Floor stand	KA-TD-H10W
Side rack	KA-TD-R100
Tilt mount unit	KA-TI-H10
Wall mount unit	KA-WA-H10WV
Ceiling mount unit	KA-CH-H10



This symbol on the nameplate means the product is Listed by Underwriters Laboratories Inc. It is designed and manufactured to meet rigid U.L. safety standards against risk of fire, casualty and electrical hazards.

CONFIGURATIONS OF RS232C TERMINALS

RS232C TERMINAL

Terminal : HDB9-PIN

Connect the serial port of computer to this terminal with Serial Cross Cable (not supplied).

Pin Configuration

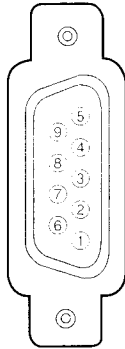

1	No Connect	6	DSR
2	R x D	7	No Connect
3	T x D	8	No Connect
4	DTR (5V)	9	No Connect
5	Ground		

INTERFACE

Protocol	RS-232C
Boadrate	9600 bps
Data length	8 bits
Parity	-
Stop bit	2 bits
Flow control	-

COMMAND

OPERATION	RS232C COMMAND (ASCII)
POWER ON-OFF	C03
POWER ON	C00
POWER OFF	C01
VOLUME UP	C09
VOLUME DOWN	C0A
MUTE	C0B
INPUT (Input signal select)	C22
INPUT "VIDEO" (VIDEO1 / VIDEO2)	C23
INPUT "COMPONENT" (COMPONENT)	C24
INPUT "PC / RGB" (PC / RGB)	C25
WIDE (Wide mode select)	C10
Wide mode "Normal"	C0F
Wide mode "Natural wide"	C26
Wide mode "Zoom"	C27
Wide mode "Zoom (Caption-IN)"	C28
Wide mode "Full"	C29
PICTURE	C30
Screen Saver "Rotation-On"	C46
Screen Saver "Rotation-Off"	C47
Screen Saver "White pattern-On"	C5F
Screen Saver "White pattern-Off"	C60

EXAMPLE : POWER ON (C00)

	FUNCTION CODE / END CODE
HEX	43h 30h 30h 0Dh 0Ah
ASCII	'C' '0' '0' [CR] [LF]

CONFIGURATIONS OF PC TERMINALS

PC IN (D-SUB) TERMINAL

Terminal : HDB15-PIN

Connect the display output terminal of computer to this terminal with VGA Cable (supplied). When connecting the Macintosh computer, the MAC Adapter (not supplied) is required.

Pin Configuration

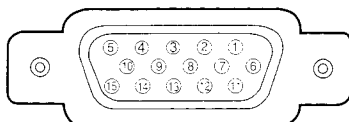

1	Red Input	9	No Connect
2	Green Input	10	Ground (Vert.sync.)
3	Blue Input	11	Sense 0
4	Sense 2	12	Sense 1
5	Ground (Horiz.sync.)	13	Horiz. sync.
6	Ground (Red)	14	Vert. sync.
7	Ground (Green)	15	Reserved
8	Ground (Blue)		

MAC ADAPTER (NOT SUPPLIED)

Set Slide Switches as shown in the table below depending on RESOLUTION MODE that you want to use before you turn-on Plasma Monitor and computer.

Slide Switches (1 ~ 6)

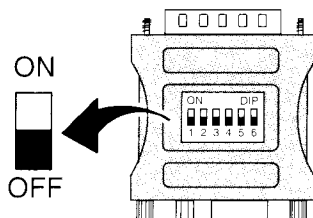

	1	2	3	4	5	6
13" MODE (640 x 480)	ON	ON	OFF	OFF	OFF	OFF
16" MODE (832 x 624)	OFF	ON	OFF	ON	OFF	OFF
19" MODE (1024 x 768)	OFF	ON	ON	OFF	OFF	OFF



Free Manuals Download Website

<http://myh66.com>

<http://usermanuals.us>

<http://www.somanuals.com>

<http://www.4manuals.cc>

<http://www.manual-lib.com>

<http://www.404manual.com>

<http://www.luxmanual.com>

<http://aubethermostatmanual.com>

Golf course search by state

<http://golfingnear.com>

Email search by domain

<http://emailbydomain.com>

Auto manuals search

<http://auto.somanuals.com>

TV manuals search

<http://tv.somanuals.com>