

INSTRUCTION MANUAL

Ultra Low Temperature Freezer

MDF-593
MDF-593AT
MDF-793
MDF-793AT



MDF-793AT



MDF-593AT

Note:

1. No part of this manual may be reproduced in any form without the expressed written permission of SANYO.
2. The contents of this manual are subject to change without notice.
3. Please contact SANYO if any point in this manual is unclear or if there are any inaccuracies.

SANYO Electric Biomedical Co., Ltd. All rights reserved. Printed in Japan.

CONTENTS

PRECAUTIONS FOR SAFE OPERATION	P. 2
CAUTIONS FOR USAGE	P. 7
ENVIRONMENTAL CONDITIONS	P. 9
FREEZER COMPONENTS	P. 10
INSTALLATION	P. 13
START-UP OF UNIT	P. 15
OPERATING INSTRUCTIONS	P. 16
TEMPERATURE RECORDER	P. 21
ROUTINE MAINTENANCE	P. 23
TROUBLESHOOTING	P. 24
DISPOSAL OF UNIT	P. 25
RECYCLE OF NICKEL-CADMIUM BATTERY	P. 26
SPECIFICATIONS	P. 27
PERFORMANCE	P. 27
SAFETY CHECK SHEET	P. 28

PRECAUTIONS FOR SAFE OPERATION

It is imperative that the user complies with this manual as it contains important safety advice.

Items and procedures are described so that you can use this unit correctly and safely. If the precautions advised are followed, this will prevent possible injury to the user and any other person.

Precautions are illustrated in the following way:



WARNING

Failure to observe WARNING signs could result in a hazard to personnel possibly resulting in serious injury or death.

CAUTION

Failure to observe CAUTION signs could result in injury to personnel and damage to the unit and associated property.

Symbol shows;

-  this symbol means caution.
-  this symbol means an action is prohibited.
-  this symbol means an instruction must be followed.

Be sure to keep this manual in a place accessible to users of this unit.

< Label on the unit >



This mark is labeled on the cover in which the electrical components of high voltage are enclosed to prevent the electric shock.















The cover should be removed by a qualified engineer or a service personnel only.

WARNING

As with any equipment that uses CO₂ gas, there is a likelihood of oxygen depletion in the vicinity of the equipment. It is important that you assess the work site to ensure there is suitable and sufficient ventilation. If restricted ventilation is suspected, then other methods of ensuring a safe environment must be considered. These may include atmosphere monitoring and warning devices.

PRECAUTIONS FOR SAFE OPERATION

WARNING

-  **Do not use the unit outdoors.** Current leakage or electric shock may result if the unit is exposed to rain water.
-  **Only qualified engineers or service personnel should install the unit.** The installation by unqualified personnel may cause electric shock or fire.
-  **Install the unit on a sturdy floor.** If the floor is not strong enough or the installation site is not adequate, this may result in injury from the unit falling or tipping over.
-  **Never install the unit in a humid place or a place where it is likely to be splashed by water.** Deterioration of the insulation may result which could cause current leakage or electric shock.
-  **Install a leak breaker on the power supply side** when you use the unit in humid or wet situations, as well as installing an earth plate. Consult our shops or an electrician for these installations.
-  **Never install the unit in a flammable or volatile location.** This may cause explosion or fire.
-  **Never install the unit where acid or corrosive gases are present** as current leakage or electric shock may result due to corrosion.
-  **Use a dedicated power source is used** as indicated on the rating label attached to the unit.
-  **Remove dust from the power supply plug** before inserting in a power source. A dusty plug or improper insertion may cause a hazard.
-  **Use a power supply outlet with ground (earth)** to prevent electric shock. If the power supply outlet is not grounded, it will be necessary to install a ground by qualified engineers.
-  **Never ground the unit through a gas pipe, water main, telephone line or lightning rod.** Such grounding may cause electric shock in the case of an incomplete circuit.
-  **Never store volatile or flammable substances** in this unit. This may cause explosion or fire.
-  **Never store corrosive substances** in this unit. This may lead to damage to the inner components or electric parts.
-  **Disconnect the power supply to the unit prior to any repair or maintenance** of the unit in order to prevent electric shock or injury.

PRECAUTIONS FOR SAFE OPERATION

WARNING

 **Ensure you do not inhale or consume medication or aerosols** from around the unit at the time of maintenance. These may be harmful to your health.

As with any equipment that uses CO₂ gas, there is a likelihood of oxygen depletion in the vicinity of the equipment. It is important that you assess the work site to ensure there is

 **suitable and sufficient ventilation. If restricted ventilation is suspected, then other methods of ensuring a safe environment must be considered. These may include atmosphere monitoring and warning devices.**

 **Never splash water directly onto the unit** as this may cause electric shock or short circuit.

 **Never disassemble, repair, or modify the unit yourself.** Any such work carried out by an unauthorized person may result in fire or injury due to a malfunction.

 **Disconnect the power supply plug if there is something wrong with the unit.** Continued abnormal operation may cause electric shock or fire.

 If the unit is to be stored unused in an unsupervised area for an extended period, **ensure that children do not have access and that doors cannot be closed completely.**

 **The disposal of the unit should be accomplished by appropriate personnel. Always remove doors** to prevent accidents such as suffocation.













 **Connect a carbon dioxide cylinder or a oxygen gas cylinder** to this unit correctly. Incorrect connection may cause explosion or fire.

 **Ventilate the room air when using the carbon dioxide gas for the back-up system.** The CO₂ density level in the air could rise and may be harmful to humans.

 **Make sure to prepare a safety check sheet** when you request any repair or maintenance for the safety of service personnel.





PRECAUTIONS FOR SAFE OPERATION

CAUTION

-  **Select a level and sturdy floor for installation.** This precaution will prevent the unit from tipping. Improper installation may result in water spillage or injury from the unit tipping over.
-  **Connect the unit to a power source as indicated on the rating label attached to the unit.** Use of any other voltage or frequency other than that on the rating label may cause fire or electric shock.
-  **When removing the plug from the power supply outlet, grip the power supply plug, not the cord.** Pulling the cord may result in electric shock or fire by short circuit.
-  **Never damage or break the power supply plug or cord. Do not use the supply plug if its cord is loose.** This may cause fire or electric shock.
-  **Do not touch any electrical parts** such as the power supply plug or any switches with a wet hand. This may cause electric shock.
-  **Do not put a container with water or heavy articles on the unit.** It may cause injury if the articles fall. Current leakage or electric shock may be resulted from the deterioration of insulation by spilled water.
-  **Do not climb onto the unit or do not put articles on the unit.** This may cause injury by tipping or damage to the unit.
-  **Do not put glass bottles or cans into the compartment** since they may be broken by frozen contents and cause injury.
-  **Put on dry gloves when you take out refrigerated articles from the freezer.** Handling frozen contents or the inside walls with naked hands may cause frostbite.
-  **Do not defrost inside walls using a knife or ice pick.** There are pipelines for cooling behind the walls. **Be careful not to damage the lines** as this could cause a breakdown. Also, **do not make a hole in the wall** for installation of attachments.
-  **Always hold the handle when closing the door.** This will reduce the likelihood of a trapped finger.
-  **Check the filter mentioned in this manual and clean it as necessary.** A dusty filter may cause temperature rise or failure.
-  **Check the setting temperature when starting up the operation after the power failure or power off.** A change of set temperature may cause damage to contents.

PRECAUTIONS FOR SAFE OPERATION

CAUTION

-  **Do not touch the condenser directly** when the filter is removed for cleaning. This may cause injury by hot surface.
-  **Always disconnect the power supply plug** before moving the unit. Take care not to damage the power cord. A damaged cord may cause electric shock or fire.
-  **Be careful not to tip over the unit** during movement to prevent damage or injury.
-  **Always disconnect the power plug** when the unit is not used for long periods.
-  **Do not put the packing plastic bag within reach of children** as suffocation may result

CAUTIONS FOR USAGE

- Always use a dedicated power source. The power source of this freezer is single phase and local voltage. The power source should be the dedicated circuit with a dedicated breaker. Do not connect this freezer to the branch circuit for other electric appliances.
- For AT type, turn OFF the back-up switch at the time of opening of the freezer door when a liquid CO₂ gas cylinder is connected to the back-up system.
- Put on dry gloves when you take out refrigerated articles from the freezer. Handling frozen contents or the inside walls with naked hands may cause frostbite.
- For the cleaning of the unit, use a cloth containing diluted neutral dishwashing detergent. Undiluted detergent may break the plastic parts. For the dilution, follow the instruction enclosed with the detergent. When a diluted neutral dishwashing detergent is used to clean the unit, wipe the unit thoroughly with a cloth soaked in clean water. Then wipe the unit with a dry cloth to eliminate the moisture.
- Do not clean the unit with scrubbing brushes, acid, thinner, solvents, powdered soap, cleanser or hot water. These agents can scratch the paint or cause it to peel. Plastic and rubber parts can be easily damaged by these materials. Especially never use any volatile solvent to clean the plastic or rubber parts.
- The cooling pipe is routed in the rear of the freezer. Never use a knife or a screw driver, etc. to remove the frost. They may cause damage of chamber wall or improper operation of the unit. And do not make any holes for attaching accessories on the freezer wall.
- The digital thermometer of this unit is designed to display the temperature of the center part of the freezing compartment. Although the thermometer sometimes displays a temperature about 2°C higher than the actual temperature of the center part, it gradually approaches the real temperature.
- Do not put too many warm articles into a freezer compartment before enough operating. Put items in a few at a time after the freezer compartment temperature has cooled enough.
- The space near the freezer compartment door, about 10 cm from the inner lid, sometimes shows a higher temperature than the center part. The difference is about 5°C; the lower part may be better for long term storage.
- Before operating the freezer, an inner lid should be put in to reduce temperature difference between top and bottom of the freezing compartment.
- When it is desired to place an instrument requiring measuring cable and power cord in the cabinet, the cable and cord can be led through the access port provided on the left side wall on the cabinet. After installation, replace a rubber cap and insulation as they are. Failure to use a rubber cap or insulation can interfere with the proper lowering of temperature and lead to condensation on the outside of the port.

CAUTIONS FOR USAGE

- This unit is provided with the filter check lamp. If the filter check lamp is flashed, clean the condenser filter. Refer to page 23 "Cleaning of condenser filter". A clogged filter may cause poor cooling and compressor trouble.
- When connecting a liquid CO₂ cylinder for the back-up system of AT type freezer, consult your dealer or a neighboring engineering shop of high pressure gas.
- Leave the remote alarm switch "OFF" until the inside temperature of the freezer reaches the appropriate level. Leave the back-up system switch "OFF" as well for AT type. After the inside temperature reaches the appropriate level, set the needle for the warning device operation of the temperature recorder.
- When the unit is first installed, or re-started after long period of no use, the power failure alarm may not operate, because its Cadnica batteries have completely discharged. This does not denote a malfunction. In this case, continue to operate the unit for about 3 hours. To fully recharge the completely discharged batteries, the unit has to be operated for about 2 days.
- Cover the control panel with the control panel cover to avoid the malfunction resulting from an accidental contact with control panel (such as power switch OFF).

ENVIRONMENTAL CONDITIONS

This equipment is designed to be safe at least under the following conditions (based on the IEC 1010-1):

1. Indoor use;
2. Altitude up to 2000 m;
3. Ambient temperature 5°C to 40°C
4. Maximum relative humidity 80% for temperature up to 31°C decreasing linearly to 50% relative humidity at 40°C;
5. Mains supply voltage fluctuations not to exceed $\pm 10\%$ of the nominal voltage;
6. Other supply voltage fluctuations as stated by the manufacturer;
7. Transient over-voltages according to Installation Categories (Over-voltage Categories) II; For mains supply the minimum and normal category is II;
8. Pollution degree 2 in accordance with IEC 664.

FREEZER COMPONENTS

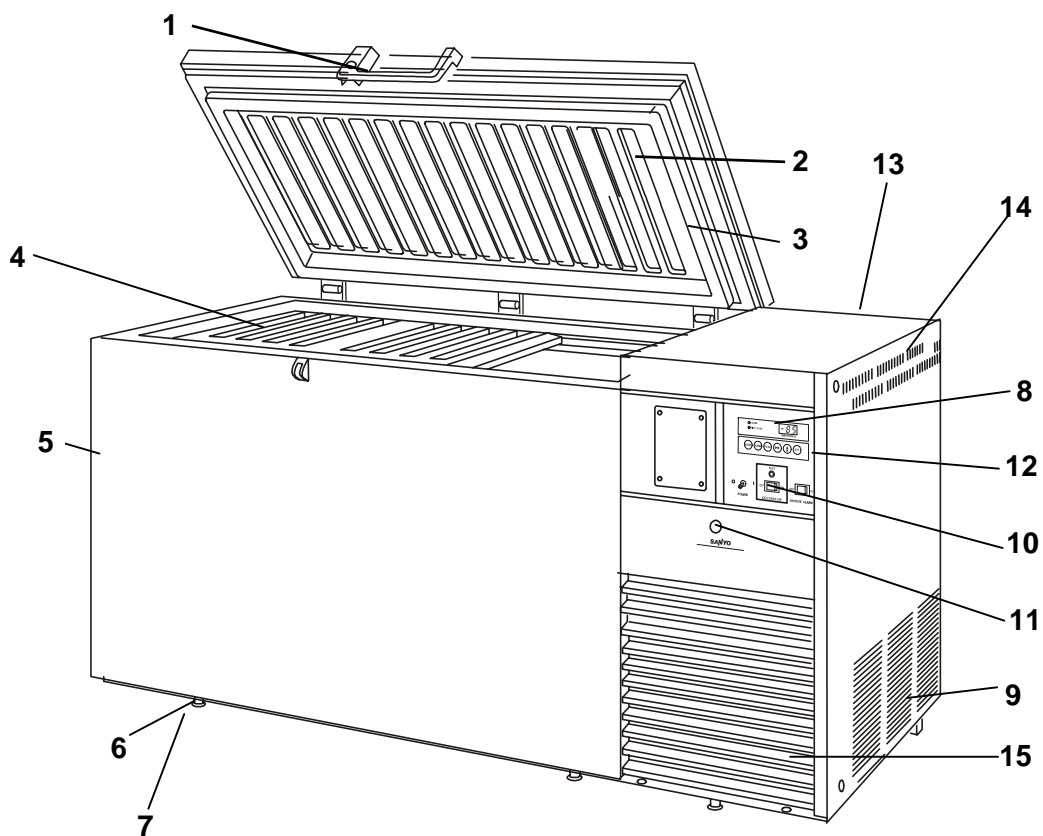

MDF-593

FREEZER COMPONENTS

1. Lock

2. Door: Hinged type. The door can be opened in any angle on the way to full open.

3. Magnetic door gasket: Seals the door and prevents leakage of cold air.

4. Inner lid: Serves as a means of reducing cold air leakage when the door is open. Remove the frost before it is accumulated too much.

5. Access port: Serves a means of leading the measuring cable from the freezing room to the outside.

6. Caster: 4 casters are provided. They make the moving of the unit easier.

7. Leveling foot: Serves to adjust the height and to settle the frame.

8. Temperature display area: The digital temperature indicator, alarm lamp, and filter check lamp are installed.

9. Exhaust air vent: Be careful not to block this.

10. Control panel cover

11. Control panel cover lock: To lock the control panel cover to avoid the setting by accidental contact.

12. Control panel: Temperature set key, power switch and so on are installed. AT type has a temperature recorder and switches of back-up system. Refer to page 12 for details.

13. Back-up system joint (rear side): It is positioned at rear of the unit. Serves to connect with the pipelines from the liquid CO₂ cylinder.

14. Side panel: For cleaning the condenser filter and condenser. The remote alarm terminal is located inside the panel.

15. Air intake vent (grille): Do not block this vent to keep the proper cooling performance.

FREEZER COMPONENTS

Control panel

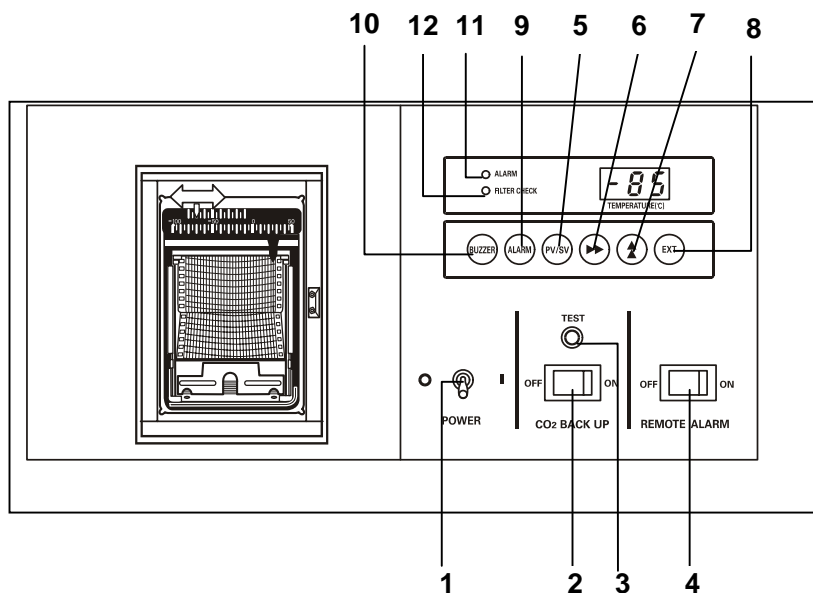

1. **Power switch (POWER):** Power all functions except remote alarm and back-up system for AT type.
2. **CO₂ Back-up switch (CO₂ BACK UP):** AT type only.
3. **CO₂ Back-up test switch (TEST) (AT types only):** AT type only.
4. **Remote alarm switch (REMOTE ALARM):** This switch is for remote alarm. In case of operating remote alarm, turn the switch to "ON".
5. **Mode setting key. (PV/SV):** This key has functions.
 - PV: Present freezer compartment temperature is displayed.**
 - SV: Setting temperature is displayed.** When the desired temperature is set, this key should be passed (SV side). The temperature setting can be done by using (6),(7),(8), keys, initial setting temperature is -85°C.
6. **Digit shift key (▶▶):** The digital of the figure displayed for temperature adjustment can be shifted using this key.
7. **Numerical value shift key (▲):** The figure that is displayed digitally can be changed by pressing this key.
8. **Enter key (ENT):** When the desired temperature is reached, press this key. Operation will commence toward this new point.
9. **Alarm test key (ALARM):** Check that the alarm lamp and the buzzer are functional when the deep-freezer is operating well.
10. **Buzzer key (BUZZER):** To stop the alarm from sounding, press this key. Should a further abnormality occur, the buzzer will sound automatically.
11. **Alarm lamp (ALARM) and buzzer:** they operate in the following cases:
 - a) **Break down or power failure at the power supply.**
 - Alarm lamp flickering, buzzer sounds.
 - b) **Temperature rises about 10°C higher than the setting temperature.**
 - Alarm lamp flickering, buzzer sounds about 15 minutes later.
12. **Filter check lamp (FILTER CHECK):** This lamp lights when the condenser filter is clogged.

INSTALLATION

Installation site

To operate this unit properly and to obtain maximum performance, install the unit in a location with the following conditions:

- **A location not subjected to direct sunlight**

The direct sunlight to the freezer causes too high temperature and the chamber temperature may not reach -85°C .

- **A location with adequate ventilation**

Leave at least 10 cm around the unit for ventilation. Poor ventilation will result in a reduction of the refrigeration capacity.

- **A location away from heat generating sources**

Avoid installing the unit near heat-emitting appliances such as gas ranges or stoves. Heat can cause inefficient refrigeration.

- **A location with a sturdy and level floor**

Install the unit on a sturdy floor to avoid vibration and noise. Placing the unit on an unsteady floor may cause vibration and noise.

- **A location not prone to high humidity**



WARNING

Install the unit on a sturdy floor. If the floor is not strong enough or the installation site is not adequate, this may result in injury from the unit falling or tipping over.

Select a level and sturdy floor for installation. This precaution will prevent the unit from tipping. Improper installation may result in water spillage or injury from the unit tipping over.

- **A location not prone to high humidity**



WARNING

Do not use the unit outdoors. Current leakage or electric shock may result if the unit is exposed to rain water.

Never install the unit in a humid place or a place where it is likely to be splashed by water. Deterioration of the insulation may result which could cause current leakage or electric shock.

- **A location without flammable or corrosive gas**



WARNING

Never install the unit in a flammable or volatile location. This may cause explosion or fire.

Never install the unit where acid or corrosive gases are present as current leakage or electric shock may result due to corrosion.

INSTALLATION

Installation

1. Remove the packaging materials and tapes

Remove all transportation packaging materials and tapes. Open the doors and ventilate the unit. If the outside panels are dirty, clean them with a diluted neutral dishwashing detergent. (Undiluted detergent can damage the plastic components. For the dilution, refer to the instruction of the detergent.) After the cleaning with the diluted detergent, always wipe it off with a wet cloth. Then wipe off the panels with a dry cloth.

2. Adjust the leveling foot

Extend the leveling feet by rotating them counterclockwise to contact them to the floor. Ensure the unit is level.

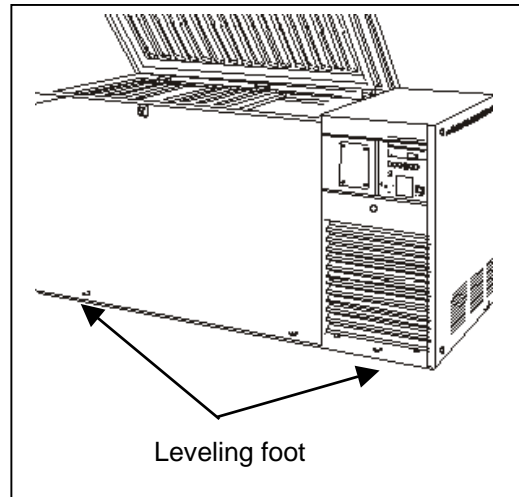

3. Fix the unit

Two fixtures are attached to the rear of the frame. Fix the frame to the wall with these fixtures and rope or chain.

If holes can be opened on the wall, open a hole with a 10.5mm diameter and fix the frame by using the chain supplied with this unit.

4. Ground (earth)

⚠ WARNING

Use a power supply outlet with ground (earth) to prevent electric shock. If the power supply outlet is not grounded, it is necessary to install a ground by qualified engineers.

Never ground the unit through a gas pipe, water main, telephone line or lightning rod. Such grounding may cause electric shock in the case of an incomplete circuit.

START-UP OF UNIT

Follow the procedures for the initial and consequent operations of the unit.

1. Make sure that all the switches on the control panel, such as the power switch, the remote alarm switch, the back-up system switch (AT type only) are off.
2. Liquid CO₂ gas cylinder for AT type is set at this time.
3. Shut the door and connect the power cable to the power supply after the inner lid is installed.
4. Turn on the power supply switch and the temperature is displayed on the digital indicator.
5. Set the desired chamber temperature by using the keypads on the control panel. Do not set the chamber temperature at lower than -90°C.
6. Set the temperature at which the back-up system activates according to the procedure on page 20 when the temperature display pointer of temperature recorder corresponds with the desired temperature if the back-up system is used. (AT type only)
7. Switch on the remote alarm switch and CO₂ back-up switch (AT type only).
8. Check that the alarm lamp lights and the buzzer sound by pressing the alarm test key.
9. Make sure that liquid CO₂ spouts into the chamber by pushing the CO₂ back-up test switch.
10. Now you can put articles into the freezer chamber. Switch off the remote alarm switch and the CO₂ back-up switch (AT type only) temporarily when putting in a lot of warm articles. Switch on these switches again after a certain period of operation.

Operation after power failure

The set value is memorized by nonvolatile memory in the event of power failure. Accordingly, the freezer resumes the operation with setting before power failure.





OPERATING INSTRUCTIONS

Temperature setting

Table 1 shows the basic operation method. Perform key operations in the sequence indicated in the table. The example in the table is based on the assumption that the temperature is -70°C.

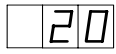
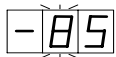
Note: The unit is set at the factory that the chamber temperature is -85C.

Table 1. Basic operation sequence (Example: Chamber temperature -70°C)

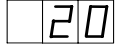
	Description of operation	Key operated	Indication after operation
1	Turn on the power switch.	----	The current chamber temperature is displayed. 
1	Press mode change key when changing the set temperature during operation.	PV/SV	The second digits blinks. 
2	Set the second digit to 7 with the numerical value shift key.		When pressed, the figure of settable digit changes.
3	By pressing the digit shift key, set the first digit.		The first digit blinks.
4	Set the first digit to 0 with the numerical value shift key.		When pressed, the figure of settable digit changes.
5	Press enter key.	ENT	Set temperature is memorized and the current chamber temperature is displayed. 

Note: The temperature set mode returns to the temperature display mode automatically when 90 seconds has passed without any key operation.

Remote alarm terminal

The terminal of the remote alarm is located at rear of the machinery room, upper side of the electric box. The signal is contact output. The recommended contact capacity is between 2 A (DC 30V) .

Contact output: : normal close connect with N.O. and COM.

Consult our dealer or our office for installation of the remote alarm.

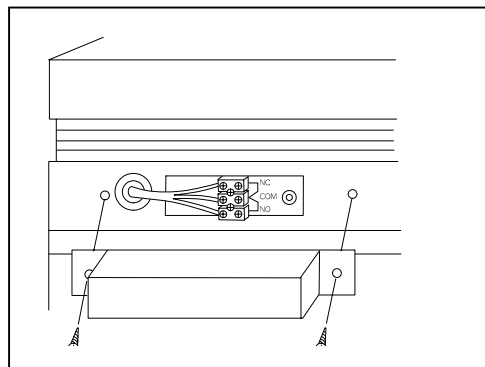

OPERATING INSTRUCTIONS

Alarm temperature setting

This unit is provided with the high temperature alarm. The setting of high temperature alarm is 10°C or 15°C (The setting value is 2 kinds.) higher than the setting of chamber temperature. The procedure in table 2 shows the sequence to set the high temperature alarm at 15°C higher than the setting of chamber temperature. Set the figure to 000 at step 5 when setting the high temperature alarm at 10°C higher than the setting of chamber temperature.

Note:

The alarm temperature is set at the factory 10°C higher than the setting of chamber temperature.

Table 2. High temperature alarm setting (15°C higher than the setting of chamber temperature)

	Description of operation	Key operated	Indication after operation
1		-----	The current chamber temperature is displayed.
2	Press the numerical value shift key for about 5 seconds.		The first digit blinks.
3	Set the first digit to 1 with the numerical value shift key.		The first digit blinks.
4	Press ENT key.	ENT	The first digit blinks.
5	Set the first digit to 1 with the numerical value shift key.		When pressed, the figure of settable digit changes.
6	Press ENT key.	ENT	Alarm temperature is memorized and the current chamber temperature is displayed.

Note: The setting is not memorized if the mode change key (PV/SV) is pressed during alarm temperature setting. The chamber temperature is displayed for 3 seconds when the numerical value shift is pressed 5 times continuously.

OPERATING INSTRUCTIONS

Setting of alarm resume time

The alarm buzzer is silenced by pressing BUZZER key on the control panel during alarm condition (Initial setting 100: The remote alarm is not silenced).

The buzzer will be activated again after certain suspension if the alarm condition is continued. The suspension time can be set by following the procedure shown in the Table 3 below.

The example in the table is based on the assumption that the desired duration is 30 minutes.

Note: The duration is set to 100 (no alarm resume time) at the factory.

Table 3. Setting procedure (change to 30 minutes from no alarm resume time)

	Description of operation	Key operated	Indication after operation
1		-----	The current chamber temperature is displayed.
2	Press the numerical value shift key for about 5 seconds.		The first digit blinks.
3	Set to F25 with the digit shift key and numerical value shift key.		The settable digit is shifted.
			When pressed, the figure of settable digit changes.
4	Press ENT key.	ENT	The current setting is displayed and the first digit blinks.
5	Set to 130 with the digit shift key and numerical value shift key.		The settable digit is shifted.
			When pressed, the figure of settable digit changes.
6	Press ENT key.	ENT	Alarm resume time is memorized and the current chamber temperature is displayed.

- The settable alarm resume time is between 10 and 60 minutes with 1 minute increment. (The setting is 010, 111, ----- 159, 160). The buzzer would not reset if the resume time is set in 000.
- The buzzer is ON when the resume time is changed in F25 while the resume time is counted (the buzzer is silenced by BUZZER key). The count of resume time is stopped.
- The setting cannot be changed during power failure.
- The set mode returns to the temperature display mode automatically when 90 seconds has passed without any key operation. In this case, any setting before pressing ENT key is not memorized.
- It is selectable whether the buzzer is in conjunction with the remote alarm or not when the buzzer is silenced by BUZZER key. (The remote alarm is not in conjunction with the buzzer by factory setting.)
- The remote alarm is activated in conjunction with the buzzer if the third digit "1" is set to "0" in the step 5 above

OPERATING INSTRUCTIONS

Alarm and safety functions

This unit has the alarm and safety functions shown in table below, and also self diagnostic function.

Table 4. Alarm and safety function

Alarm & safety	Situation	Indication	Buzzer	Safety operation
High temperature alarm	When the chamber temp. is approx. 10°C (or 15°C) higher than the set temp.	Alarm lamp blinks.	Intermittent tone with 12 min. delay	Remote alarm with 12 min. delay
Power failure alarm	At power failure When power cord is disconnected.	Alarm lamp blinks.	Intermittent tone	Remote alarm
Filter check	When the condenser filter is clogged.	Filter check lamp lights.	-----	-----
Auto-return	When there is no key pressing in each setting mode for 90 seconds.	Chamber temp. is displayed.	-----	Finishing of each setting mode
Sensor abnormality	If the thermal sensor is disconnected.	Alarm lamp blinks. E01 and 50°C is displayed alternately.	Intermittent tone	Remote alarm Continuous operation
	If the thermal sensor is short-circuited.	Alarm lamp blinks. E01 and -170°C is displayed alternately.		
	If the cascade sensor is disconnected.	Alarm lamp blinks. E03 and chamber temp. is displayed alternately.	Intermittent tone	Remote alarm
	If the cascade sensor is short-circuited.	Alarm lamp blinks. E04 and chamber temp. is displayed alternately.		
	If the filter sensor is disconnected.	Alarm lamp blinks. E05 and chamber temp. is displayed alternately.	Intermittent tone	Remote alarm
	If the filter sensor is short-circuited.	Alarm lamp blinks. E06 and chamber temp. is displayed alternately.		

Note:

The filter check lamp sometimes lights at the start-up under high ambient temperature. The lamp will be off when the chamber temperature is getting lower.

Operation after power failure

The set value (setting of chamber temperature and alarm temperature) is memorized by nonvolatile memory. Accordingly, the freezer resumes the operation with setting before power failure.

OPERATING INSTRUCTIONS

Back-up system

WARNING

As with any equipment that uses CO₂ gas, there is a likelihood of oxygen depletion in the vicinity of the equipment. It is important that you assess the work site to ensure there is suitable and sufficient ventilation. If restricted ventilation is suspected, then other methods of ensuring a safe environment must be considered. These may include atmosphere monitoring and warning devices.

The freezer AT type is provided with an automatic liquid CO₂ gas injection device as a back-up system. This freezer prevents the chamber temperature from going up by injecting the liquid CO₂ gas when the power supply is disconnected (power failure, disconnection of power cord, breaker OFF) or in the case of failure of freezer itself. The liquid CO₂ gas is injected with the activation of solenoid valve energized by battery when the chamber temperature reaches the alarm temperature.

Following shows the procedure for setting the back-up system.

1. Setting of liquid CO₂ gas cylinder

By using the joint and pipe enclosed with the freezer, connect the liquid CO₂ gas cylinder to the joint of the back-up system. For this setting, consult with a qualified gas supplier or Sanyo sales agency.

2. After setting the liquid CO₂ gas cylinder, operate the freezer until the chamber temperature reaches the required level.

3. Set the warning indicator of the recorder at the temperature higher than -70°C. The back-up system is operated continuously if the warning indicator is set at the temperature lower than -70°C. This means the liquid CO₂ gas is consumed very quickly.

4. Switch on the back-up system.

5. Make sure that liquid CO₂ gas spouts into the freezer chamber by pressing the CO₂ back-up test switch.

Note:

- The liquid CO₂ gas cylinder loses its cooling capacity at speed when the ambient temperature is over 31°C. Install the liquid CO₂ gas cylinder in the cool environment. And the duration of back-up time per one liquid CO₂ gas cylinder varies depending on the ambient temperature. Refer to "Installation of back-up system" enclosed with the freezer for the available back-up time.
- The liquid CO₂ gas cylinder should be a siphon type.
- Use the pipe enclosed with the freezer for the setting. (The extension of the pipe is not permitted)

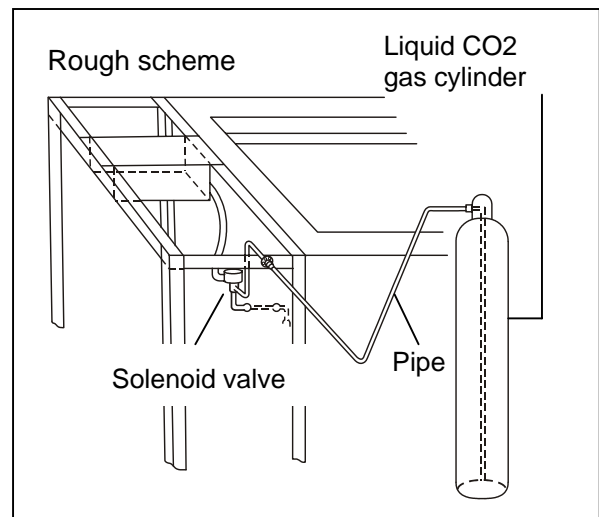

because of cooling capacity.)

TEMPERATURE RECORDER

The figure below shows the description of a temperature recorder. The temperature recorder is provided with model AT type.

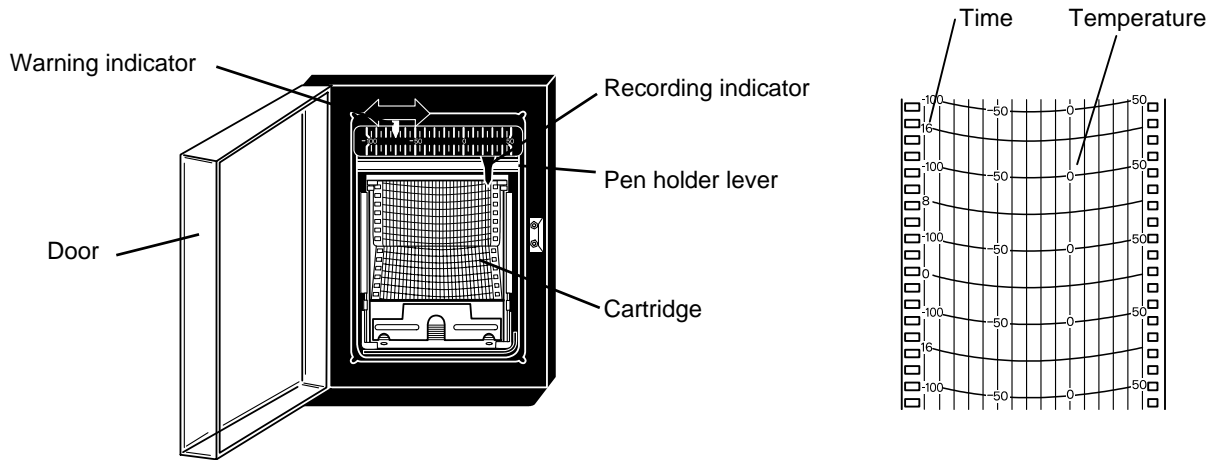

Feeding of chart

1. Open the door and let down the lever of the penholder; the pen point is apart from the chart. (Fig. 1)
2. Pull the cartridge out of the mounted position. (Fig. 2)
3. Set a new chart in place on the rear bottom of the cartridge. Set the hole on the chart in the cog of the chart driving assembly and feed the chart in the direction of the arrow by driving the cog wheel.
4. Set the chart according to the mark of day and time. (Fig. 3)
5. When mounting, lay down the cartridge first, and push into the mounting position with the groove set a the projection on the position.
6. Set up the cartridge and settle in position.

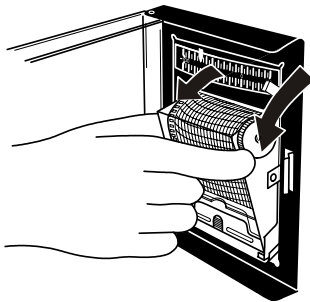

Fig. 1

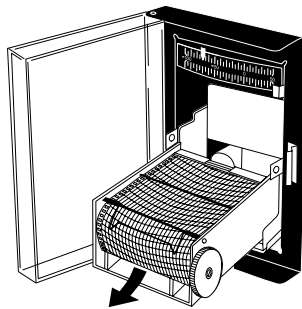

Fig. 2

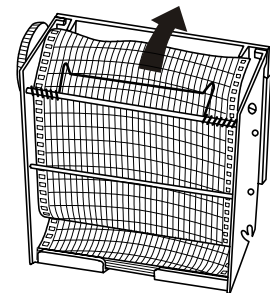
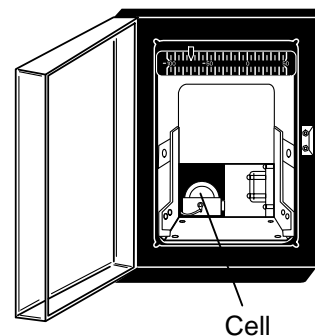

Fig. 3

Replacement of cell

Replace the dry cell once a year as follows:

1. Put up the penholder first, then pull out cartridge from the mounted position.
2. Reset the battery chamber cover with wire, on the bottom left side, and take out the cell.
3. Set a new cell by turning its anode to this side.
4. Shut the cover after exchanging cells. Mount the cartridge as before and lay down the penholder.



TEMPERATURE RECORDER

Setting of back-up temperature

1. There is a red guide on the top of the temperature displayer. Adjust the guide with your finger to back-up temperature, at which temperature the auxiliary cooling system starts to operate.
2. Set at a temperature 15°C higher than that of the freezer compartment.

Penholder

Install a recording pen in the recording hand as shown in the figure. Make sure that the pen is completely inserted for accurate recording. The pen is packed together with the chart.

1. Let down the lever of the penholder, then pull out the cartridge from the mounted position.
2. Insert a new pen.
3. Mount the cartridge into place.
4. Lift up the penholder lever and make sure that the pen point touches the chart.

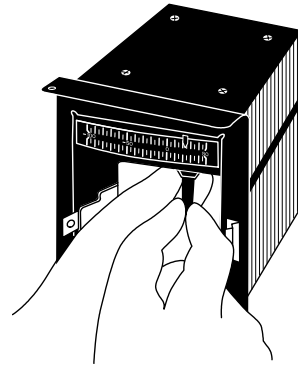

Note:

- Turn off the back-up switch when the freezer operation is stopped or the back-up system is not used. The battery for back-up system is discharged when the back-up switch is kept on.
- The additional felt pen or recording paper is available from Sanyo sales agency.
- To stop the temperature recorder, remove the cell from the recorder. The back-up system can operate without recorder cell. Always remove a felt pen as well because the recording paper can be torn resulting from ink spot. The torn paper may interfere pen tip movement, which results in no activation of back-up system.
- The cell for recorder normally keeps about 1 year. However, the cell life is shorten depending on the ambient temperature condition. The enclosed cell may have shorter life since it is for monitor.
- The liquid leakage or rust can be caused when a used cell or a cell over effective limit is left as it is, which gives adverse effect on the recorder.

ROUTINE MAINTENANCE

⚠ WARNING

Always disconnect the power supply to the unit prior to any repair or maintenance of the unit in order to prevent electric shock or injury.

Ensure you do not inhale or consume medication or aerosols from around the unit at the time of maintenance. These may be harmful to your health.

Cleaning

1. Clean the unit once a month. Regular cleaning keeps the unit looking new.
2. Use a dry cloth to wipe off small amounts of dirt on the outside and inside of the unit and all accessories. If the outside panels are dirty, clean them with a diluted neutral dishwashing detergent.. (Undiluted detergent can damage the plastic components. For the dilution, refer to the instruction of the detergent.)
3. After the cleaning with the diluted, always wipe it off with a wet cloth. Then wipe off the cabinet or accessories with a dry cloth.
4. Never pour water onto or into the unit. Doing so can damage the electric insulation and cause failure.
5. The compressor and other mechanical part are completely sealed. This unit requires absolutely no lubrication.
 - There is a fan behind the compressor, so be very careful if you stick your hand into this part of the unit.

Cleaning of condenser filter

This unit is provided with the filter check lamp. This lamp flickers and the buzzer sounds when the condenser filter is clogged. Clean the filter according to the following procedure. As a clogged filter may cause poor cooling and compressor trouble, clean it once a month.

1. The filter fitted to the grille can be removed as shown in the figure.
2. Remove the mounting screw securing the grille and pull out the grille.
3. Remove the filter installed inside the grille, wash it with water and dry it naturally.
4. Replace the clean filter as before.
5. Replace the grille and tighten the screw and check that the filter check lamp is off.

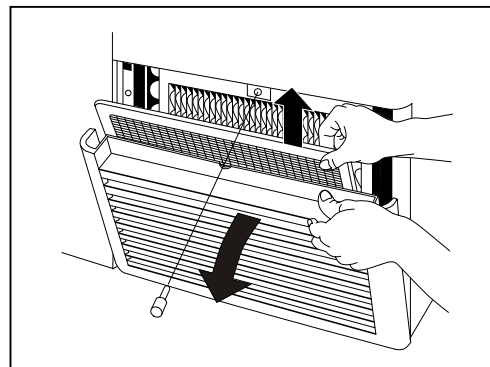

Defrosting of inside wall

Defrost the inside wall of the freezer as follows:

Normal defrosting

Remove the frost by the enclosed scraper. Take care not to damage the inside wall.

Thorough defrosting

1. Take out and transfer all the contents to another freezer or container which contains liquid CO₂, liquid N₂, or dry ice. Switch off the alarm and back-up system of AT type. Switch off the power supply.
2. Open the door and remove the inner lid. Leave the freezer as it is. The water remaining in the freezer compartment should be wiped up.
3. After cleaning is completed, restart the operation according to the procedure. Put back the articles into the sufficiently cooled freezer compartment.

TROUBLE SHOOTING

If the unit malfunctions, check out the following before calling for service, after transferring all the contents to another freezer

No refrigeration

- The voltage is too low. (In this case, call an electrician.)
- The breaker is free.
- The fuse is blown.

Sometimes the freezer is not cooled at all for about 5 minutes after starting-up.

Poor refrigeration

- The ambient temperature is too high.
- The door is not shut tightly.
- The inner lid is not installed correctly.
- The set temperature in the controller is not set properly.
- The grille is blocked out.
- The filter is clogged. Clean the filter when the filter check lamp lights.
- The freezer is in the direct sunlight.
- There is any heating source near the freezer.
- A rubber cap and insulation for the access port are not set correctly.
- You put too many unfrozen articles into the freezer compartment.
- Too much frost is accumulated in the chamber.

Noise

- The freezer is not installed on the sturdy floor.
- There is anything touching the frame.
- The freezer is not leveled with the leveling feet.
- It is the immediately after starting of refrigeration.

The freezer causes larger noise when the chamber temperature is high because of large load. The noise gets smaller along with chamber temperature.

Alarm test key cannot actuate the alarm function

- The alarm test key does not function when the power switch of the freezer is OFF.
- When only the buzzer or only the alarm is actuated by the alarm test key, the unactuated part is out of order, and must be replaced.

Recorder does not operate normally (AT type only)

- If the chart is not advanced, examine the dry cell. Replace the cell for recorder every 1 year.
- If the temperature is not recorded, examine the recording pen. The pen should be our specified one.

Back-up test switch does not operate normally (AT type only)

- The liquid CO₂ cylinder is empty.
 - The valve of the liquid CO₂ cylinder is not opened.
 - The ambient temperature is too high. In this case, move the liquid CO₂ cylinder to a cool location.
- Inquire at liquid CO₂ suppliers about cylinder check, adjustment, installation, or move.

DISPOSAL OF UNIT

WARNING

If the unit is to be stored unused in an unsupervised area for an extended period **ensure that children do not have access and doors cannot be closed completely.**

The disposal of the unit should be accomplished by appropriate personnel. Always remove doors to prevent accidents such as suffocation.

RECYCLE OF NICKEL-CADMIUM BATTERY



The unit contains a rechargeable battery. The battery is recyclable. At the end of its useful life, check with your local solid waste officials for an option or proper disposal.

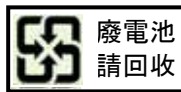

* Label indication is obliged to comply with Taiwanese battery regulation.

Location of a nickel-cadmium battery

This unit is provided a nickel-cadmium battery for the power failure alarm. The battery is located in the control box behind the control panel.

Removal of nickel-cadmium battery

1. Turn off the power switch and disconnect the power supply plug.
2. As shown in the Fig. 1, remove 4 fixing screws on the front panel and remove the front panel.
3. Remove 4 fixing screws on the control panel and take out the control panel. (Fig. 2)
4. Remove 2 fixing screws on the control box to remove the control box cover. (Fig. 3)
5. Remove 2 screws fixing the clips securing the battery and then disconnect the connector. (Fig. 4)

Handling of battery

Cover the battery terminal with an insulating tape to avoid the short circuit. Then follow the procedure for recycling or proper disposal.

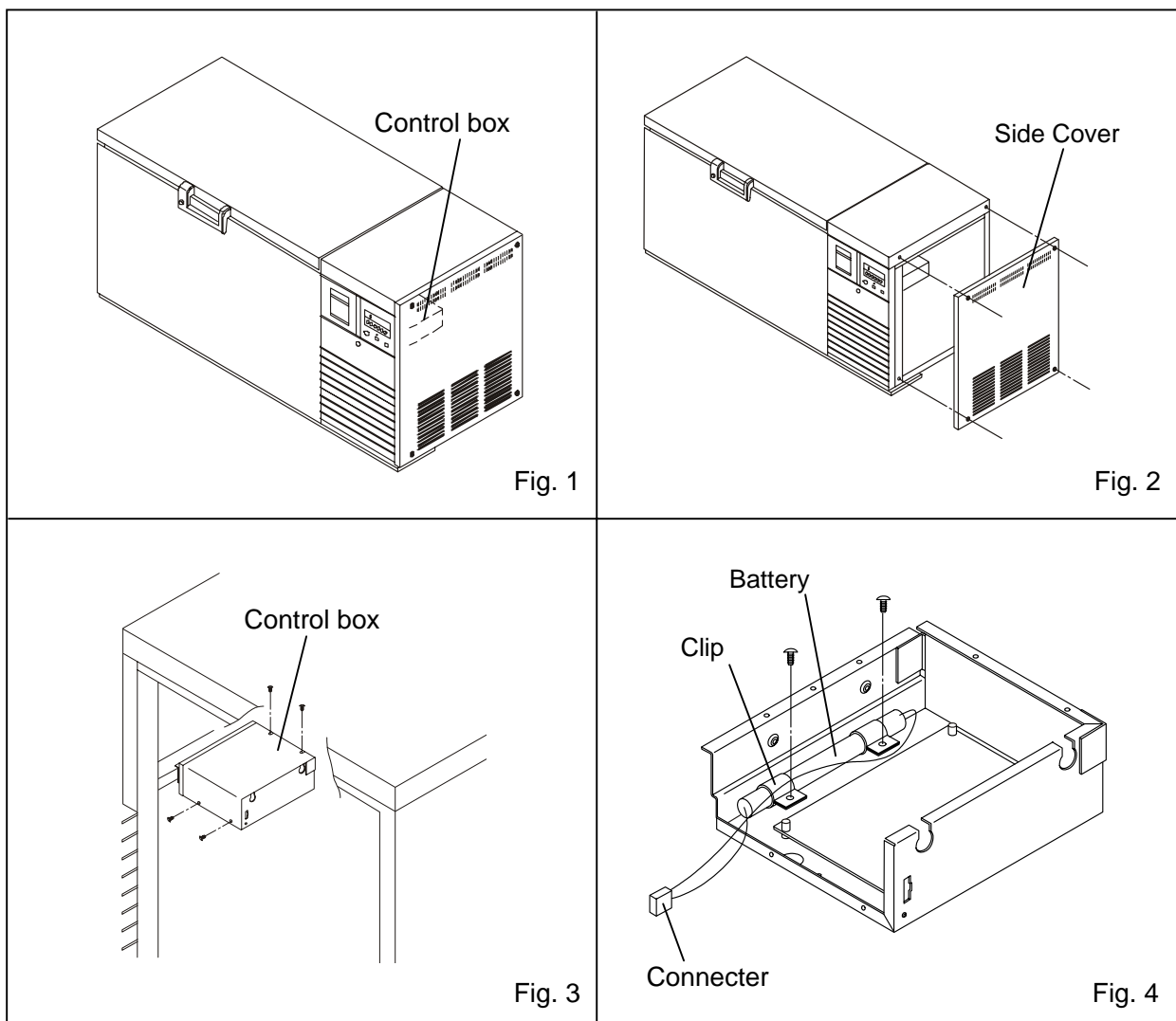

SPECIFICATIONS

Name	Ultra-Low Temperature Freezer	
Model	MDF-593/MDF-593AT	MDF-793/MDF-793AT
External dimensions	W2010 x D770 x H1070 (mm)	W2570 x D770 x H1070 (mm)
Internal dimensions	W1280 x D500x H762 (mm)	W1840 x D500x H762 (mm)
Effective capacity	487 L	701 L
Exterior	Baked on acrylic finish on galvanized steel	
Interior	Stainless steel	
Door	Baked on acrylic finish on galvanized steel	
Insulation	Rigid polyurethane foamed-in place	
Compressor	Hermetic type	
Motor for compressor	High stage side; 750 W Low stage side; 750 W	High stage side; 1100 W Low stage side; 1100 W
Condenser	High stage side; fin and tube type, Low stage side; shell and tube type	
Evaporator	Tube on sheet type	
Refrigerant	High stage side; R-407D , Low stage side; R-508 (TP5R3)	
Power source	AC 200 V, 60 Hz	
Temperature controller	Microprocessor control system, Setting range; -20 to -95°C, 1°C graduation	
Temperature display	Digital display (+50 to -100°C)	
Sensor	Pt 100	
Alarm	Nickel-cadmium battery, Remote alarm contact, Buzzer and lamp	
Battery	For power failure alarm; 6VDC, 270mAh	
Voltage booster	Electrical; 208/230 V, 1 HP, 60 Hz Minimum operating voltage; 193 V at start-up of compressor	
Accessories	1 set of key, 2 rubber caps, 1 scraper	
Weight	319 kg	380 kg
Option	Aluminum container; MDF-59SC, Inventory rack; IR213C, IR309C Temperature recorder; MTR-85H, CVK-UB2	

Note: Design or specifications will be subject to change without notice.

The battery for power failure alarm is an article for consumption. It is recommended that the battery will be replaced about every 3 years. Contact Sanyo sales agency at the time of replacement of the battery for recycling.

PERFORMANCE

Model	MDF-593/MDF-593AT	MDF-793/MDF-793AT
Cooling performance	Center part of freezing room; -86°C (Ambient temperature; +30°C, no load)	
Temperature Control range	-20 to -85°C	
Power source	AC 200V, 60Hz	
Rated power consumption	1100 W	1240 W
Noise level	61 dB [A] (background noise; 20 dB)	
Maximum pressure	1.9 MPa	2.1 MPa

Note : The unit with CE mark complies with EC directives 89/336/EEC, 93/68/EEC and 73/23/EEC

CAUTION

Please fill in this form before servicing.

Hand over this form to the service engineer to keep for his and your safety.

Safety check sheet

1. Refrigerator contents :
- Risk of infection: Yes No
- Risk of toxicity: Yes No
- Risk from radioactive sources: Yes No

(List all potentially hazardous materials that have been stored in this unit.)

Notes :

2. Contamination of the unit

- Unit interior Yes No
- No contamination Yes No
- Decontaminated Yes No
- Contaminated Yes No
- Others: Yes No

3. Instructions for safe repair/maintenance of the unit

- a) The unit is safe to work on Yes No
- b) There is some danger (see below) Yes No

Procedure to be adhered to in order to reduce safety risk indicated in b) below.

Date :

Signature :

Address, Division :

Telephone :

Product name: Ultra-low temperature freezer	Model: MDF-	Serial number:	Date of installation:
---	----------------	----------------	-----------------------

Please decontaminate the unit yourself before calling the service engineer.

7FB6P10140500
(25 Feb. 2005)

Recycled paper



SANYO Electric Biomedical Co., Ltd.

10-15, Hongo 3-Chome
Bunkyo-ku, Tokyo 113-8434 Japan

Printed in Japan

Free Manuals Download Website

<http://myh66.com>

<http://usermanuals.us>

<http://www.somanuals.com>

<http://www.4manuals.cc>

<http://www.manual-lib.com>

<http://www.404manual.com>

<http://www.luxmanual.com>

<http://aubethermostatmanual.com>

Golf course search by state

<http://golfingnear.com>

Email search by domain

<http://emailbydomain.com>

Auto manuals search

<http://auto.somanuals.com>

TV manuals search

<http://tv.somanuals.com>