

-30°C Biomedical Freezers

MDF-U730
(automatic defrost)

MDF-U730M
(manual defrost)



SANYO MDF Series -30°C biomedical freezers offer superior uniformity for a wide variety of storage and research applications. Designed with all the features for laboratory grade freezing of enzymes and vaccines, including microprocessor control and large, flexible storage capacity.

Models: MDF-U730M and MDF-U730

SANYO is committed to developing green technologies that provide energy efficiency resulting in lower operational costs with less impact on the environment.



-30°C and -20°C Biomedical Freezers and Applications

“Plug-in and Go” Laboratory Grade freezing for safe storage of enzymes, vaccines, and other biologics. Designed with all the features required for biomedical research and biotechnology applications such as superior uniformity, microprocessor control, and large, flexible storage capacity. Additionally, items such as two access ports, casters, remote alarm contacts, and security features (a keyed door lock and padlock handle) are always included as standard features.

- In medical applications, SANYO MDF Series biomedical freezers provide effective storage of life-saving vaccines as well as samples for diagnosis.
- In biotechnology applications, they provide effective storage of enzymes for genetic research as well as culture media, reagents and samples for testing.
- In industrial applications, they are ideal for aging and temperature tests on electronic components, precision devices, and compound resins.

Features

Stable Temperature Control

Using SANYO microprocessor technology the MDF series provides precise and uniform storage temperatures regardless of ambient conditions, with a settable temperature range from -20°C to -30°C in 1°C increments. Built-in alarm and product safety functions are also provided as standard features.



Sample Protection Functions

Digitally Adjustable Temperature Setpoint, High and Low Temperature Alarm, Door Ajar Alarm, Remote Alarm Contacts, and Non-Volatile Memory Backup. Both visual and audible alarms are standard.

Quiet Operation

SANYO's energy-efficient refrigeration design requires no noisy condenser fan. In combination with low dB level compressor, this unit is uniquely quiet and perfect for in-lab installations.



Easy Maintenance

Natural cooling of the unit's condenser eliminates the need for a condenser fan. Periodic cleaning of a filter is therefore not required, making periodic maintenance minimal. Standard casters and leveling feet make relocation easy.

SANYO Refrigeration

Sanyo designed and built rotary compressor offers high performance, reliability and peace of mind. Heated mullion under door gasket prevents frost build up.

Sample Storage Security

Standard keyed door lock and integrated padlock hasp are standard features.



Adjustable Shelving System

Four adjustable wire shelves with over 100 pound capacity each allows for flexible material storage configurations.



Construction

MDF-U730

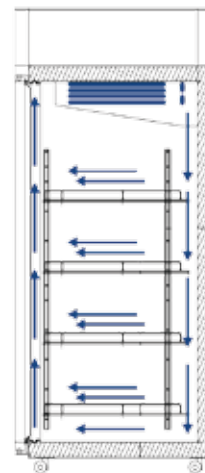

Forced Air Flow
(side view)

MDF-U730M

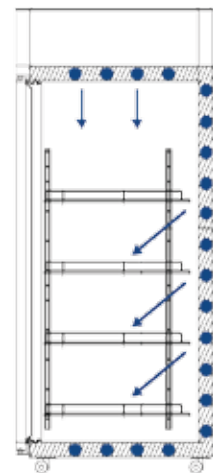

Gravity Air Flow
(side view)

Performance Data

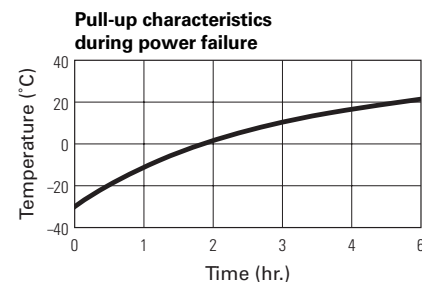
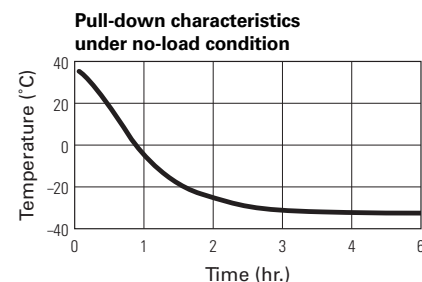

Conditions:
AT 35°C, no load, measured at center of chamber

MDF-U730 / Auto Defrost

General Purpose Storage - Maintenance Free

- Storage at -30°C with auto-defrost with consistent temperature control below -20°C during defrost cycle.
- Maintenance free storage - no end user intervention to defrost unit and clean-up condensate.
- Precision temperature uniformity throughout chamber due to forced air circulation with dual fans.

Forced-Air Circulation with Auto-Defrost of Evaporator

- Evaporator (Cooling Coils) provide the cooling effect and is located at the top of the inner chamber.
- Air flow inlets and outlets direct the air flow across the evaporator to cool the air.
- Dual Circulation fans add to excellent overall uniformity (uniform temperatures) inside the cabinet.
- Evaporator heater is activated during defrosting cycle to turn frost into water. The water drains out the back of unit into a condensate pan. The water (condensate) is eventually evaporated into the air by a heater in the condensate pan, making the unit maintenance free for the end user in terms of defrosting and dealing with the melted condensate (water).



MDF-U730M / Manual Defrost

Enzyme & Biologics Preservation

- Storage at -30°C and -20°C easily with constant stable control.
- Uniform temperatures through out chamber using Full Cold Wall construction.
- Because there is no defrost cycle, the inner chamber temperature offers outstanding uniformity and stability.



Full Cold Wall Design with Manual Defrost

- Unlike many other cold wall freezers, SANYO locates evaporators in the walls not only along both sides and the back of the chamber, but also on the top and the bottom of the chamber to ensure maximum cooling performance.
- With no air flow fans inside the chamber only natural convection of any temperature difference will move the air.
- Shelves for product storage have full flexibility in placement.
- Because there is no defrost cycle, from time to time manual defrosting of the inner chamber is necessary.



Enzyme Storage Freezer Bins (MDF-U730M Only)

The optional full storage system, Model #: 730MFB creates a flexible and convenient inventory system for enzymes and many other types of samples. The total system includes 14 storage bins and additional wire shelving.



Freezer Bin Dimensions

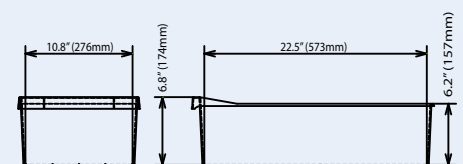

Specifications



Model	MDF-U730	MDF-U730M
Effective Capacity	22.3 cu.ft. (632L)	24.4 cu.ft. (690L)
Exterior Dimensions (W x D x H)	30.3" x 32.7" x 77.0" (770 x 830 x 1955) mm	30.3" x 32.7" x 77.0" (770 x 830 x 1955) mm
Interior Dimensions(Net) (W x D x H)	25.6" x 28.0" x 53.9" (650 x 710 x 1370) mm	25.6" x 27.5" x 59.8" (650 x 700 x 1520) mm
Net Weight (Approx.)	330 lbs. (150 kg)	330 lbs. (150 kg)
Exterior	Painted Steel	
Interior	Painted Steel	
Insulation	CFC-free polyurethane foamed-in place	
Compressor	1/2 HP (400W), Hermetic Rotary type	
Defrosting System	Automatic defrost of evaporators	Manual defrost
Refrigerant	Environmentally friendly, HFC refrigerant (R-404A)	
Shelves (Max.load)	4 adjustable wire shelves, 110 lbs. (50 kg) capacity each	
Access Ports	Diameter 30 mm (left) / Diameter 20 mm (top)	
Temperature Control	Microprocessor control, LED display, digital input	
Temperature Range	-18°C to -30°C (Ambient Temperature: 35°C)	
Casters	4 casters with 2 adjustable feet	
Alarm and Safety	High/low temp alarm, door ajar alarm, power failure, remote alarm contacts, memory backup	
Accessories	1 key set	
Electrical	115 V, 60 Hz, 15 Amp breaker, NEMA 5-15P Plug	
Options	7-day circular temperature recorder, Inventory Racks, Storage Bin System(MDF-U730M), Extended Warranty	

Options:



Circular Chart
Temperature Recorder
MTR-C954



Complete Bin (14 total)
Storage System
Model No. 730MFB
(MDF-U730M only)



Inventory Rack
SUR-624-I
Rack Capacity:24

Dimensional Data

MDF-U730

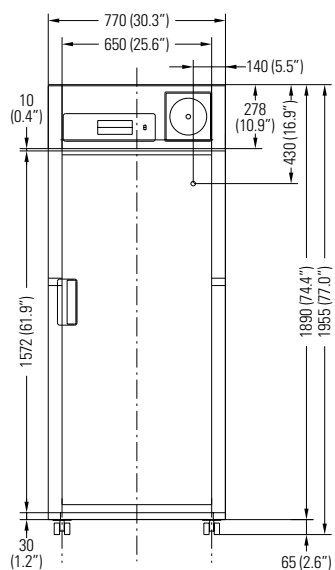

MDF-U730M

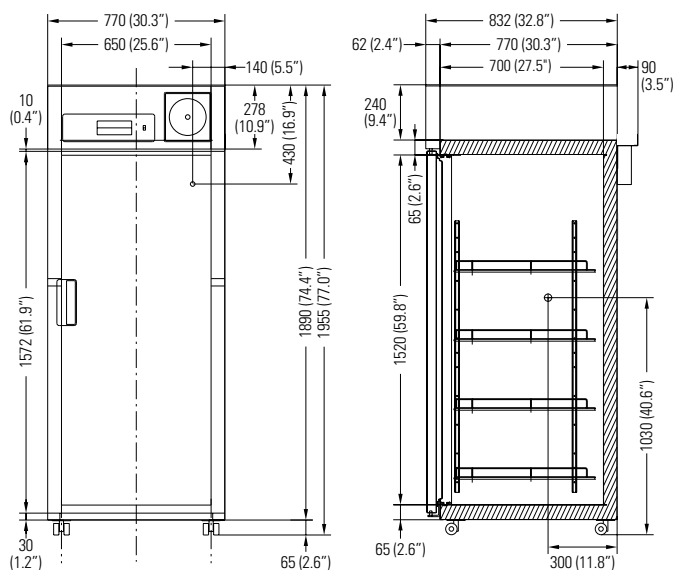

Product conforms to RoHS
(European Restriction of Hazardous
Substance directives)



SANYO Commercial Solutions
A Division of SANYO North America Corporation
1300 Michael Drive, Wood Dale, IL 60191 USA
Toll Free USA 800-858-8442 • Fax 630-238-0074
www.sanyobiomedical.com

SANYO Canada, Inc.
1-300 Applewood Crescent, Concord, Ontario L4K 5C7
905-760-4025 • Fax 905-760-9945

Validation Services

SANYO offers a wide range of high quality validation services for all of our equipment. These services include on site validation, custom validation, custom validation support packages, factory acceptance testing, critical utility qualifications, NIST traceable calibration. Choosing SANYO as an equipment supplier and validation consultant can greatly reduce the time and cost involved with setting up and operating new equipment.

Download from www.Somanuals.com. All Manuals Search And Download.

Free Manuals Download Website

<http://myh66.com>

<http://usermanuals.us>

<http://www.somanuals.com>

<http://www.4manuals.cc>

<http://www.manual-lib.com>

<http://www.404manual.com>

<http://www.luxmanual.com>

<http://aubethermostatmanual.com>

Golf course search by state

<http://golfingnear.com>

Email search by domain

<http://emailbydomain.com>

Auto manuals search

<http://auto.somanuals.com>

TV manuals search

<http://tv.somanuals.com>