

SANYO

INSTRUCTION MANUAL

DTA-2680

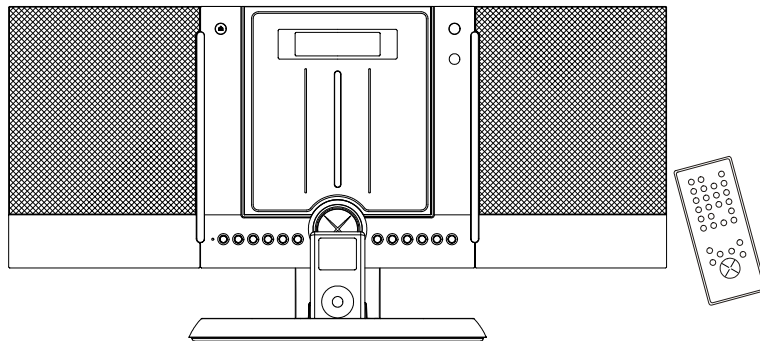

3 - Piece Audio System with
iPod Docking



SANYO Canada Inc.
www.sanyo.ca

Thank-you for choosing SANYO. This audio system includes a built-in CD player, AM/FM stereo tuner, iPod dock, alarm clock, timer, motorized CD door, removable speakers and remote control. The unit can be wall mounted in order to save desk or counter space.

SAFETY INFORMATION

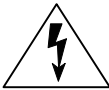
 <div style="display: inline-block; text-align: center; border: 1px solid black; padding: 5px; margin: 0 10px;"> CAUTION RISK OF ELECTRIC SHOCK DO NOT OPEN </div> 	<p>The lightning flash with arrowhead symbol within an equilateral triangle is intended to alert the user to the presence of uninsulated "dangerous voltage" within the product's enclosure that may be of sufficient magnitude to constitute a risk of electric shock to persons.</p>
<p>CAUTION: TO REDUCE THE RISK OF ELECTRIC SHOCK, DO NOT REMOVE COVER. NO USER-SERVICEABLE PARTS INSIDE. REFER SERVICING TO QUALIFIED SERVICE PERSONNEL</p>	 <p>The exclamation point within an equilateral triangle is intended to alert the user to the presence of important operating and maintenance (servicing) instructions in the literature accompanying the product.</p>

WARNING: TO AVOID THE HAZARDS OF FIRE OR ELECTRICAL SHOCK, DO NOT EXPOSE THIS APPLIANCE TO RAIN OR OTHER MOISTURE.

CAUTION: TO PREVENT ELECTRICAL SHOCK, MATCH WIDE BLADE OF PLUG TO WIDE SLOT, FULLY INSERT.

SAFETY CERTIFICATION

This unit is made and tested to meet exacting safety standards. It meets CSA and FCC requirements and complies with safety performance standards of the U.S. Department of Health and Human Services.

CAUTION - USE OF CONTROLS OR ADJUSTMENTS OR PERFORMANCE OF PROCEDURES OTHER THAN THOSE SPECIFIED HEREIN MAY RESULT IN HAZARDOUS RADIATION EXPOSURE.

THIS UNIT SHOULD NOT BE ADJUSTED OR REPAIRED BY ANYONE EXCEPT QUALIFIED SERVICE PERSONNEL.

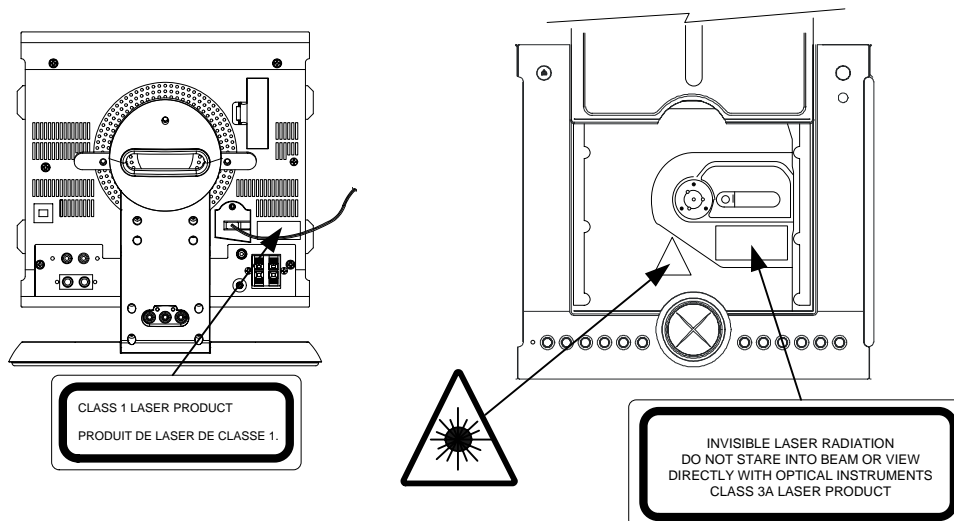

FCC information

For CD player section: This device complies with Part 15 of the FCC Rules. Operation is subject to the following two conditions: (1) This device may not cause harmful interference, and (2) this device must accept any interference received, including interference that may cause undesired operation.

NOTE:

This equipment has been tested and found to comply with the limits for a Class B digital device, pursuant to Part 15 of the FCC Rules. These limits are designed to provide reasonable protection against harmful interference in a residential installation. This equipment generates, uses and can radiate radio frequency energy and, if not installed and used in accordance with the instructions, may cause harmful interference to radio communications. However, there is no guarantee that interference will not occur in a particular installation. If this equipment does cause harmful interference to radio or television reception, which can be determined by turning the equipment off and on, the user is encouraged to try to correct the interference by one or more of the following measures:

- Reorient or relocate the receiving antenna.
- Increase the separation between equipment and receiver.
- Connect the equipment into an outlet on a different circuit from that to which the receiver is connected.
- Consult the dealer or an experienced radio/TV tech.

FOR SAFE AND EFFICIENT OPERATION

- Do not damage the power cord.
- When not in use, disconnect the power cord from the outlet. Grasp the plug, not the cord, when disconnecting the unit.
- If water should enter the unit, electrical shock or malfunction may result. Use in an area where there is low humidity and little dust.
- Do not disassemble or alter the unit in any way.
- Do not use the unit in areas where extremes in temperature occur (below 40°F or exceeding 95°F), or where it may be exposed to direct sunlight.
- Because of the CD player's extremely low noise and wide dynamic range, there is a tendency to turn the volume on the amplifier higher than necessary. Doing so may produce an excessively high output from the amplifier, which can cause damage to your speakers. Please be careful in this regard.
- Sudden changes in the surrounding temperature can cause dew to form on the optical pickup lens inside unit. Under this condition, the unit may be unable to operate properly. If this should occur, remove the disc and allow the player to adjust to the surrounding temperature.

WARNING: Handling the cord on this product or cords associated with accessories sold with this product, will expose you to lead, a chemical known to the State of California to cause cancer, and birth defects or other reproductive harm.

Wash hands after handling.

IMPORTANT SAFETY INSTRUCTIONS

1. **Read Instructions** - All the safety and operating instructions should be read before the product is operated.
2. **Retain Instructions** - The safety and operating instruction should be retained for future reference.
3. **Heed Warnings** - All warnings on the product and in the operating instructions should be adhered to.
4. **Follow Instructions** - All operating and use instructions should be followed.
5. **Cleaning** - Unplug this product from the wall outlet before cleaning. Do not use liquid cleaners or aerosol cleaners. Use a damp cloth for cleaning.
6. **Attachments** - Do not use attachments not recommended by the product manufacturer as they may cause hazards.
7. **Water and Moisture** - Do not use this product near water - for example, near a bath tub, wash bowl, kitchen sink, or laundry tub, in a wet basement, or near swimming pool, and the like.
8. **Accessories** - Do not place this product on an unstable cart, stand tripod, bracket, or table. The product may fall, causing serious injury to a child or adult, and serious damage to the product. Use only with a cart, stand, tripod, bracket, or table recommended by the manufacturer, or sold with the product. Any mounting of the product should follow the manufacturer's instructions and should use a mounting accessory recommended by the manufacturer.
9. A product and cart combination should be moved with care. Quick stops, excessive force, and uneven surfaces may cause the product and cart combination to overturn.



PORTABLE CART WARNING
(symbol provided by RETAC)

S3125A

10. **Ventilation** - Slots and openings in the cabinet are provided for ventilation and to ensure reliable operation of the product and to protect it from overheating, and these openings must not be blocked or covered. The openings should never be blocked by placing the product on a bed, sofa, rug, or other similar surface. This product should not be placed in a built-in installation such as a bookcase or rack unless proper ventilation is provided or the manufacturer's instruction have been adhered to.
11. **Power Sources** - This product should be operated only from the type of power source indicated on the marking label. If you are not sure of the type of power supply to your home, consult your product dealer or local power company. For products intended to operate from battery power, or other sources, refer to the operating instructions.

IMPORTANT SAFETY INSTRUCTIONS

12. **Grounding or Polarization** - This product may be equipped with a polarized alternating current line plug (a plug having one blade wider than the other). This plug will fit into the power outlet only one way. This is a safety feature. If you are unable to insert the plug fully into the outlet, try reversing the plug. If the plug should still fail to fit, contact your electrician to replace your obsolete outlet. Do not defeat the safety purpose of the polarized plug.
13. **Power-Cord Protection** - Power supply cords should be routed so that they are not likely to be walked on or pinched by items placed upon or against them, paying particular attention to cords at plugs, convenience receptacles, and the point where they exit from the product.
14. **Lightning** - For added protection for this product during a lightning storm, or when it is left unattended and unused for long periods of time, unplug it from the wall outlet. This will prevent damage to the product due to lightning and power-line surges.
15. **Overloading** - Do not overload wall outlet, extension cords, or integral convenience receptacles as this can result in a risk of fire or electric shock.
16. **Object and Liquid Entry** - Never push objects of any kind into this product through openings as they may touch dangerous voltage points or short-out parts that could result in a fire or electric shock. Never spill liquid of any kind on the product.
17. **Servicing** - Do not attempt to service this product yourself as opening or removing covers may expose you to dangerous voltage or other hazards. Refer all servicing to qualified service personnel.
18. **Damage requiring Service** - Unplug this product from the wall outlet and refer servicing to qualified service personnel under the following conditions:
 - a) When the power-supply cord or plug is damaged,
 - b) If liquid has been spilled, or objects have fallen into the product,
 - c) If the product has been exposed to rain or water,
 - d) If the product does not operate normally by following the operating instructions. Adjust only those controls that are covered by the operating instructions as an importer adjustment of other controls may result in damage and will often require extensive work by a qualified technician to restore the product to its normal operation.
 - e) If the product has been dropped or damaged in any way.
 - f) When the product exhibits a distinct change in performance - this indicates a need for service.

IMPORTANT SAFETY INSTRUCTIONS

- 19. Replacement Parts** - When replacement parts are required, be sure the service technician has used replacement parts specified by the manufacturer or have the same characteristics as the original part. Unauthorized substitutions may result in fire, electric shock, or other hazards.
- 20. Safety Check** - Upon completion of any service or repairs to this product, ask the service technician to perform safety checks to determine that the product is in proper operating condition.
- 21. Wall or Ceiling Mounting** - The product should be mounted to a wall or ceiling only as recommended by the manufacturer.
- 22. Heat** - The product should be situated away from heat sources such as radiators, heat registers , stoves, or other objects (including amplifiers) that produce heat.
- 23. Nonuse Periods** - Unplug the product's power cord when you will not be using it for an extended period.

LOCATION OF CONTROLS - UNIT

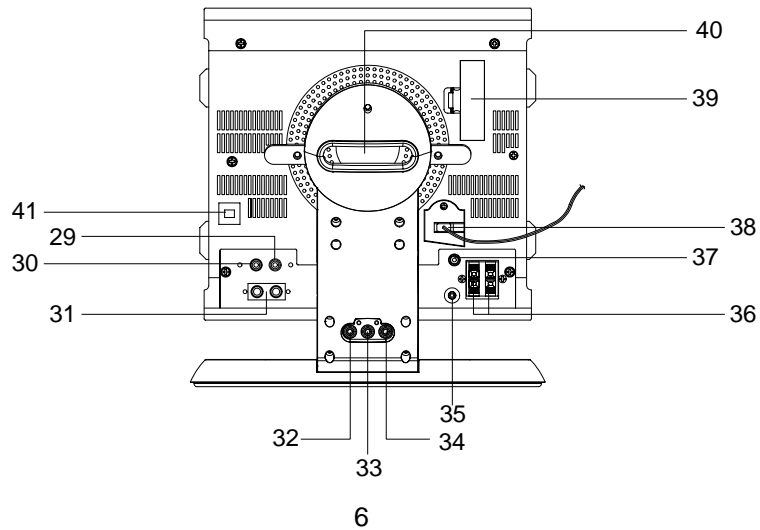
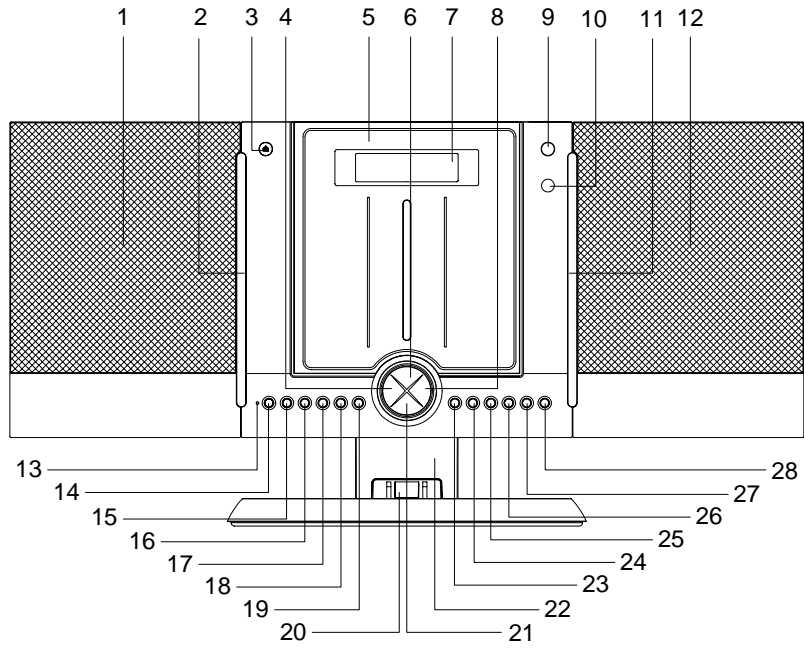

LOCATION OF CONTROLS - UNIT (cont.)

1. **Detachable Speaker (L)**
2. **Insert**
3. **CD Door OPEN/CLOSE Button**
Open or close the CD door
4. **iPod/CD-SKIP/TUNING/CLOCK Time Backward Button (⏮)**
-iPod/CD-Skip/search backward
-TUNER-Backward tuning or station search
-Clock or Timer-Select the time
-SUREWAKE vol level setting
5. **CD Door**
6. **Volume UP Button (+)**
To increase volume level
7. **LCD Display**
Shows the operating status in all modes
8. **iPod/CD-SKIP/TUNING/CLOCK Time Forward Button (⏭)**
-iPod/CD-Skip/search forward
-TUNER-Forward tuning or station search
-Clock or Timer-Select the time
-SUREWAKE vol level setting
9. **POWER ON/STANDBY Button**
To power ON, standby light should be switched off
10. **Remote Control Sensor**
11. **Insert**
12. **Detachable Speaker (R)**
13. **Surround Indicator**
14. **SURROUND ON/OFF Button**
Press to turn the surround sound ON or OFF. The indicator lights while surround is ON
15. **iPod PLAY/PAUSE ⏩ Button**
To start iPod playback/short PAUSE of iPod playback
16. **AUX Button**
To activate AUX mode
17. **MP3 MODE/ST/MO/ENTER Button**
-To display ID3 TAG information, if available during MP3 playback
-To select Stereo or Mono in TUNER FM mode
-To confirm iPod menu selected
18. **PRESET/FOLDER/SELECT ▼ Button**
-Press to retrieve preset radio station down
-Press to retrieve MP3 folder down
-Press to select iPod menu down
19. **PRESET/FOLDER/SELECT ▲ Button**
-Press to retrieve preset radio station up
-Press to retrieve MP3 folder up
-Press to select iPod menu up
20. **iPod DOCK**
21. **Volume DOWN Button (-)**
To decrease volume level
22. **Pedestal**

LOCATION OF CONTROLS - UNIT (cont.)

- 23. CD/iPod STOP Button (■)**
Interrupting the CD/iPod playback/clearing the CD program iPod charging mode
- 24. CD PLAY/PAUSE Button**
To play or pause CD playback
- 25. PROG/MENU/CLOCK SETTING Button**
-Tuner/CD program/Clock setting button (in off mode)
-iPod menu selection
- 26. TUNER/BAND Button**
Sets to tuner (radio) mode and selects the AM or FM band
- 27. DISPLAY ON/OFF Button**
To select display backlight on/off
- 28. AUX IN Jack (3.5mm)**
AUX input for stereo line level input
- 29. AUX Socket (L) (LINE OUT)**
- 30. AUX Socket (R) (LINE OUT)**
- 31. FM Antenna Bracket**
Note - Do not connect to external antenna
- 32. AUDIO OUT for iPod (R)**
- 33. AUDIO OUT for iPod (L)**
- 34. VIDEO OUT for iPod**
- 35. HEADPHONE Jack (3.5mm)**
Connect a pair of stereo headphones (not supplied) for private listening
- 36. Speaker Terminal**
Connect the speaker wires to left and right speakers
- 37. Subwoofer Jack**
To connect powered subwoofer (not supplied)
- 38. AC Input Socket**
To connect to AC power cord
Note: The cord was fixed on main unit
- 39. Battery Cover/Compartment**
For tuner and clock memory back-up, to install 1.5V x 2 "AAA" Batteries
- 40. WALL MOUNTING SLOT**
- 41. AM Antenna Socket**
AM antenna connection socket (for the frame antenna included in the accessories)

INSTALLATION (Speakers and Decorative Insert)

DISASSEMBLE AND FIX THE DECORATIVE INSERT

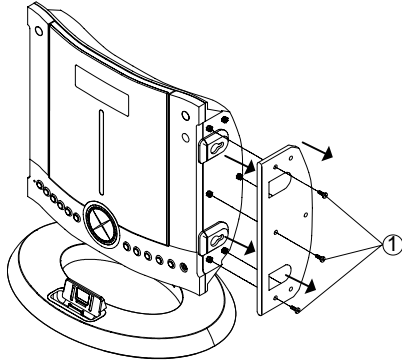

To remove the insert, release 3 pcs screws (1), then pull out the insert from the main unit.

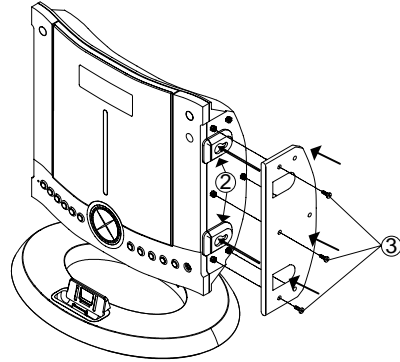

To fix the insert, place it with two holes into main unit speaker holder (2), then fix it by 3 pcs screws (3).

PLACE AND FIX THE SPEAKER

- Insert the speaker stud into the hole of the main unit (1).
- Push the speaker backward to the end until it clicks (2).

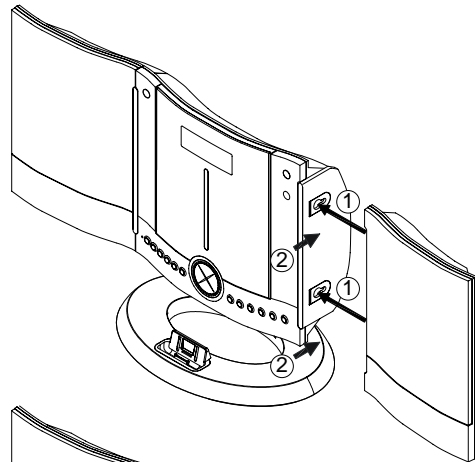

DISASSEMBLE THE SPEAKER

- Push the speaker forward from the back side (1).
- Release the speaker from the main unit speaker holder (2).

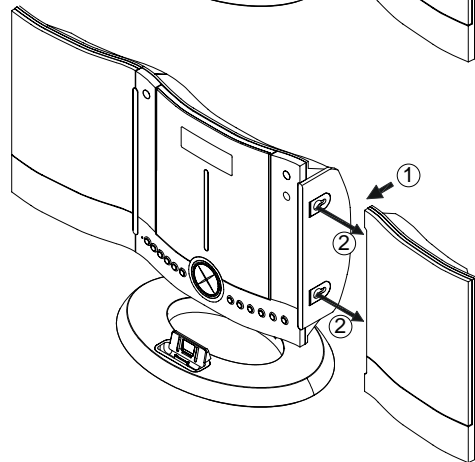

ANGLE ADJUSTMENT (Speakers)

Used to connect the bracket (included) to set the speaker box on an angle.

VERTICAL ANGLE

Insert the bracket with (A) side and push upward to adjust for vertical angle.

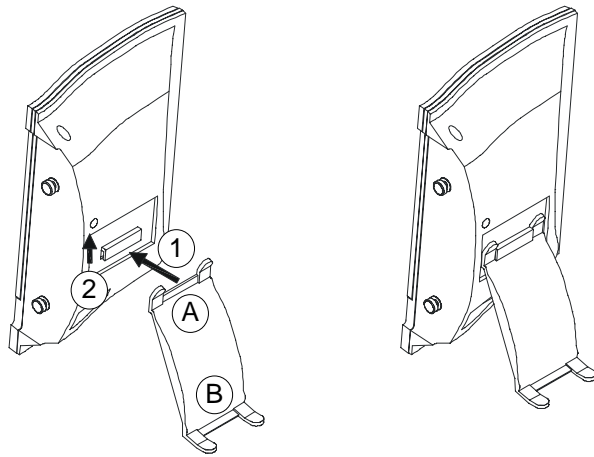

TILT ANGLE

Insert the bracket with (B) side and push upward to adjust for desired angle.

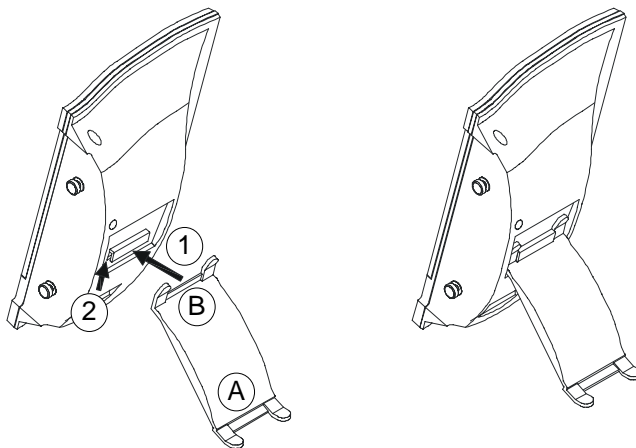

INSTALLATION (Wall Mounting)

Installation options:

- Wall mount

To mount the center section on the wall:

- Position the bracket (supplied) on the wall (as show below) where you want to hang the whole unit. Drill 2 holes slightly undersized for a firm fit.
- Secure the bracket on the wall using 2 dowels and 2 screws (supplied).
- The mounting screws should be anchored into solid wall support, such as wood frame or concrete wall. Mount the center unit onto the wall bracket.
- Make sure the mounting tab on the center unit fits securely into the mounting slot on the wall bracket.
- Screws and plastic dowels are also provided for speakers if they are to be wall-mounted away from the center section.

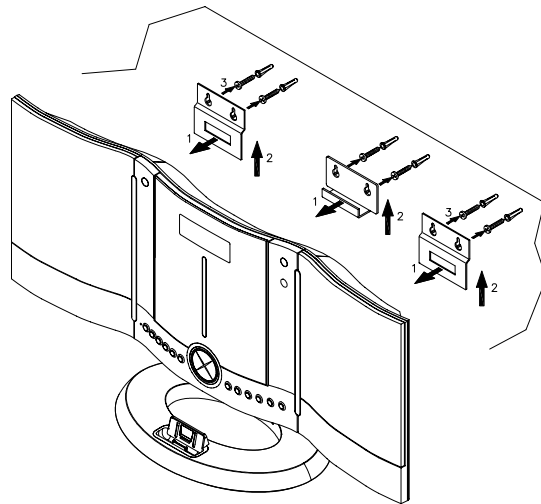

- Note: speakers can be wall mounted separately as on below drawing.

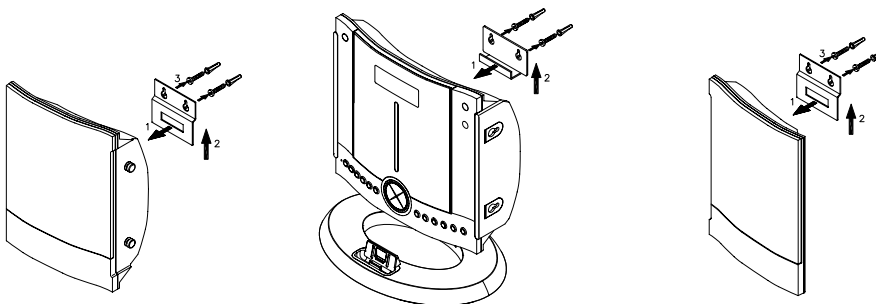

REMOTE CONTROL

Battery Installation

1. Remove the battery tray by pressing point (1a) inside, then sliding point (1b) area at the same time.
2. Pull out the battery tray.
3. Install or replace the button-type battery "CR2032" (supplied).
4. Close the battery tray.

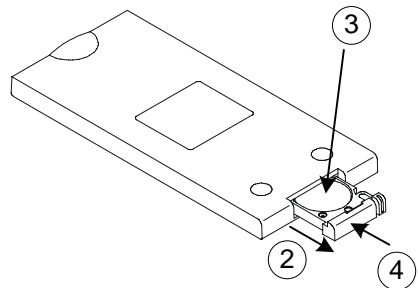
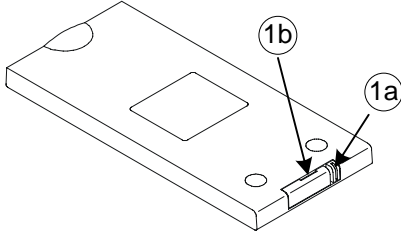
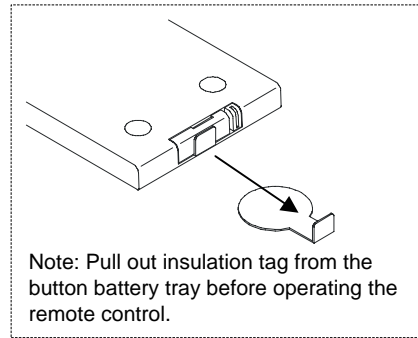

LOCATION OF CONTROLS - REMOTE CONTROL

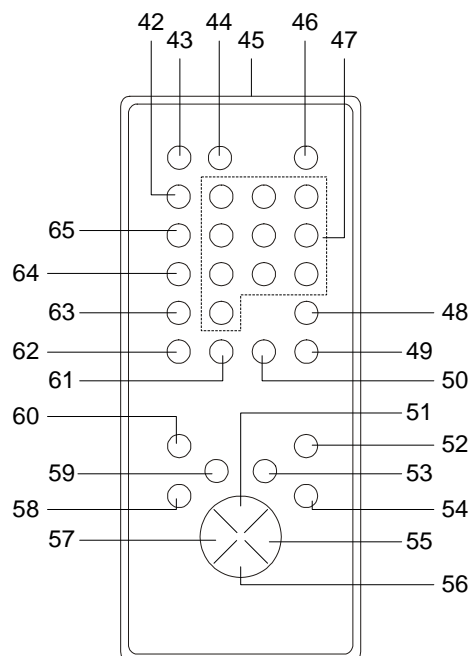

LOCATION OF CONTROLS - REMOTE CONTROL (Cont.)

- | | |
|---|--|
| <p>42. MUTE Button
To mute the sound</p> <p>43. CD Door OPEN/CLOSE Button
Press to open or close the CD door at CD mode</p> <p>44. SUREWAKE/TIMER Button
To activate surewake/deactivate the timer</p> <p>45. Remote Control Transmitter</p> <p>46. POWER ON/STANDBY Button
Switches the system on or off</p> <p>47. 0 - 9 NUMERIC Buttons
Tuner: To recall preset stations
CD: To recall tracks</p> <p>48. REPEAT Button
Repeat 1/ALL function for CD/iPod mode</p> <p>49. INTRO Button
Plays 10 seconds of each CD track</p> <p>50. RANDOM Button
CD play in random sequence</p> <p>51. Volume UP Button (+)
To increase volume level</p> <p>52. BASSXPANDER Button
Press for a rich bass sound</p> <p>53. PLAY/PAUSE ► Button
To start CD/iPod playback/short PAUSE of CD playback</p> <p>54. EQ Button
To select "PASS, CLASSIC, ROCK, POP and JAZZ" for desired sound effect</p> <p>55. iPod/CD-SKIP/TUNING/CLOCK time Forward Button (►►)
-iPod/CD-Skip/search forward
-TUNER-Forward tuning or station search
-Clock or Timer-Select the time
-SUREWAKE vol level setting adjustable</p> | <p>56. Volume DOWN Button (-)
To decrease volume level</p> <p>57. iPod/CD-SKIP/TUNING/CLOCK time Backward Button (◀◀)
-iPod/CD-Skip/search backward
-TUNER-Backward tuning or station search
-Clock or Timer-Select the time
-SUREWAKE vol level setting</p> <p>58. PRESET/FOLDER/SELECT ▼ Button
-Press to retrieve preset radio station down
-Press to retrieve MP3 folder down
-Press to select iPod menu down</p> <p>59. CD/iPod STOP Button (■)
Interrupting the CD/iPod playback/clearing the CD program iPod charging mode</p> <p>60. PRESET/FOLDER/SELECT ▲ Button
-Press to retrieve preset radio station up
-Press to retrieve MP3 folder up
-Press to select iPod menu up</p> <p>61. PROG/MENU/CLOCK SETTING Button
-Tuner/CD program/Clock setting (in off mode)
-iPod menu for selection</p> <p>62. MP3 MODE / ST/MO/ENTER Button
-To display ID3 TAG information if available during MP3 playback
-To select Stereo or Mono in TUNER FM mode
-To confirm iPod menu selected</p> <p>63. SLEEP Button
Press for sleep to music function</p> <p>64. TUNER/BAND Button
Sets to tuner (radio) mode and selects the AM or FM band</p> <p>65. SOURCE Button
To select "CD, iPod, AUX, TUNER" mode</p> |
|---|--|

POWER SUPPLY

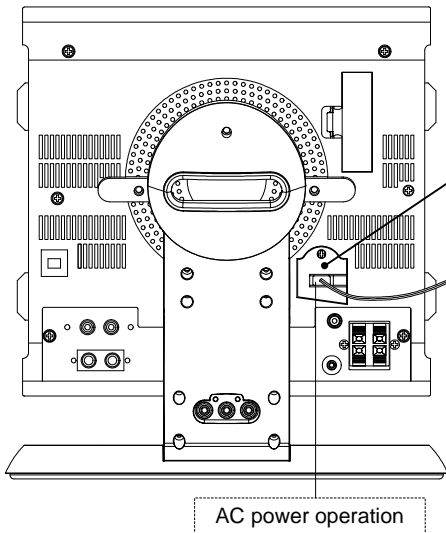

The cord is fixed on main unit.

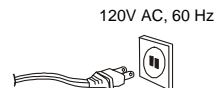

NOTE:

This unit is equipped with a polarized plug. If you have difficulty inserting the plug, turn it over and reinsert it.

CAUTION:

TO PREVENT ELECTRICAL SHOCK, MATCH WIDE BLADE OF PLUG TO WIDE SLOT, FULLY INSERT.

BATTERY SUPPLY (For Tuner/Clock Memory Back-up)

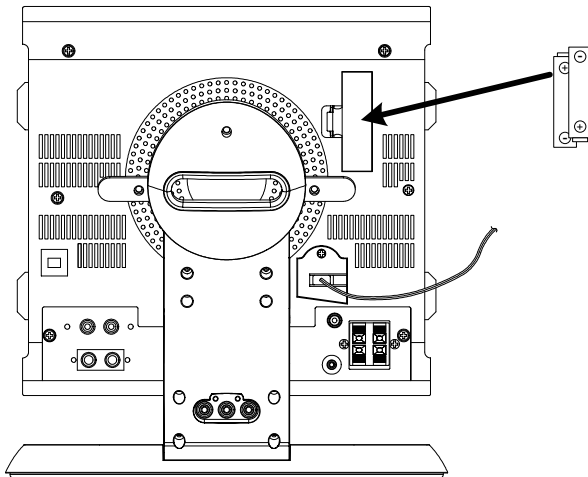

Install batteries (not supplied).
Observe + and - signs.

Remember to replace the battery compartment lid
2 "AAA" size batteries

CAUTION:

WHEN INSTALLING BATTERIES

To prevent leakage from the batteries, which are corrosive and can cause personal injury and damage to the unit, observe the following precautions:

1. The batteries must be installed correctly. Match the polarities (+ and - signs) on the batteries, to the polarities shown on the battery compartment of the unit (see above).
2. Do not mix new batteries with old or used batteries.
3. Only use batteries of the same type and brand.
4. If the unit will not be used for an extended period of time, remove the batteries and store them in a cool place.
5. Carefully follow the battery manufacturer's instructions for proper use and disposal.
6. **DO NOT ALLOW YOUNG CHILDREN TO HANDLE BATTERIES.**

IMPORTANT NOTE:
SPENT OR DISCHARGED BATTERIES MUST BE RECYCLED OR DISPOSED OF PROPERLY IN COMPLIANCE WITH ALL APPLICABLE LAWS. FOR DETAILED INFORMATION, CONTACT YOUR LOCAL COUNTRY SOLID WASTE AUTHORITY.

OPERATING INSTRUCTIONS

POWER ON/OFF

When the AC power is connected, "-- -- : -- --" shows on the LCD display.

1. Press the POWER/STANDBY button to turn the unit 'ON'.

Note: The LCD display lights up and "HELLO" greeting shows on display, the STANDBY LED light goes off. Volume at 13 (max 30).

2. You can now select your desired music source by pressing one of the function buttons: TUNER/BAND or CD PLAY/PAUSE  or AUX or iPod on main console.

3. To switch to POWER OFF, press the POWER/STANDBY button to turn the unit 'OFF'. "GOOD BYE" appears on display. The STANDBY LED lights.

4. Display back light ON/OFF won't be affected by power ON/OFF.

 /ON



Example : FM mode









 /ON



NOTE: Please turn off the unit to standby mode before disconnecting main power supply from the unit.

SETTING THE TIME

When the unit is first connected to an AC power outlet, the display shows "-- -- : -- --". To set the clock to the current time proceed as follows:

1. In power off mode, press and hold the PROG button for 2 seconds, the "12" hour digits begin to flash.
2. Press the  /  to select your desire either 12 or 24 hour clock time format.
3. Press the PROG button to hour mode until the hour flashes.
4. Press the  /  to adjust the hour time while it is flashing. Be sure to set the hour correctly for AM or PM.
5. Press PROG button once to minute mode and the minutes will flash.
6. Press the  /  to adjust the minute time while it is flashing.
7. Press the PROG button once more, the display stops flashing and the clock begins to run.

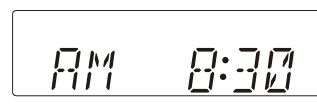
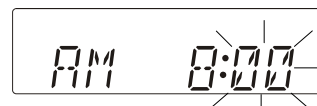
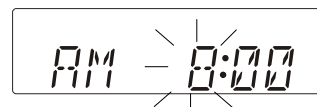
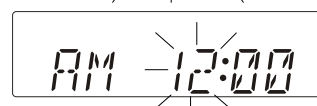
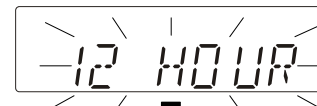
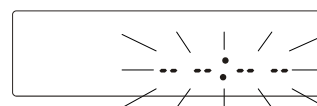

TIMER ON/OFF SETTING

NOTE: The clock should be adjusted before the Timer On/Off setting.

1. Press the SUREWAKE TIMER button on remote control once, the TIMER ON indicator and hour digit begin to flash.
2. Press the ◀◀ / ▶▶ to adjust the hour time up or down. Be sure to set the hour correctly for AM or PM.
3. Press the SUREWAKE TIMER button once, the minute digits begin to flash.
4. Press the ◀◀ / ▶▶ to adjust the minute time up or down.
5. Press the SUREWAKE TIMER button on remote control again, the TIMER OFF indicator and hour digit begin to flash.
6. Press the ◀◀ / ▶▶ to adjust the hour time up or down. Be sure to set the hour for correctly for AM or PM.
7. Press the SUREWAKE TIMER button once, the minute digits begin to flash.
8. Press ◀◀ / ▶▶ button to adjust the minute time up or down.
9. Press the SUREWAKE TIMER button once; setting to: TUNER or CD or iPod are selected by pressing the ◀◀ / ▶▶ button.
10. Press the SUREWAKE TIMER button, then press the ◀◀ / ▶▶ to select the volume level.
11. Press the TIMER button on remote control once more, then the Timer On and Off adjustment is finished with the "⊕" display remaining ON (The SUREWAKE TIMER setting will show you once on display).

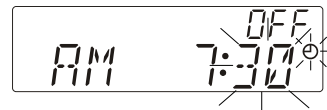
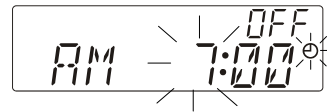
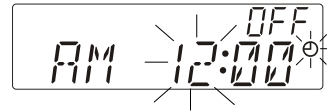
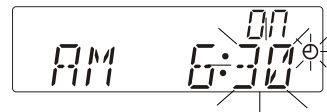
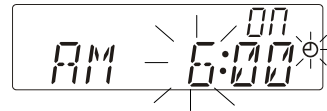
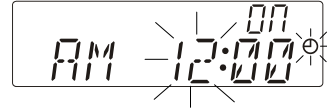

Note: Timer function with **SUREWAKE** starts the music quietly and then increases the volume to room level or your selected volume level to make sure you are awake.

To cancel the Timer On setting, press SUREWAKE TIMER button on remote control until "⊕" display goes off.

Note : To turn off the set while timer is on, press POWER button.

SETTING THE SLEEP

Pressing SLEEP button on remote control permits settings from 10 to 90 minutes. When the desired time appears, releasing your finger will set the time. (Pressing "SLEEP" after the 10 minute showed, sleep timer position will cancel the sleep timer.)

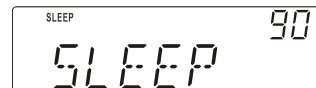

Change of SLEEP Setting



BASIC OPERATION

Electronic volume control

Electronic volume control display



1. Press VOL-DOWN (-) button to adjust sound level down, the volume level (00 - 30) will be shown in the LCD display.
2. Holding down the button will result in continuous decrease of the sound level.
3. Similarly, press VOL-UP (+) button to adjust sound level up.

Muting Function

If the MUTE button is pressed, the audio output will be muted, and the current display begins to flashing.



Pressed the MUTE button again to resume.



BASSXPANDER Control

Press the BASSXPANDER button to get the rich bass sound.

BASSXPANDER shows on display

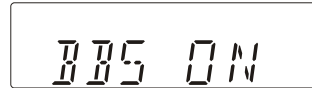

To switch off the BASSXPANDER function, press the button once more.

BASSXPANDER shows on display

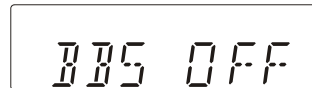

PRESET EQUALIZATION

Press the EQ button on remote control repeatedly to cycle through the preset EQ showing on the LCD display -- PASS, CLASSIC, ROCK, POP and JAZZ.

LISTENING TO THE RADIO

1. Press the POWER/STANDBY button to turn the system 'ON'.
2. Press the TUNER/BAND button to select the radio function.



Example : FM mode



3. Press the TUNER/BAND button repeatedly to select AM or FM band.
4. Press the SKIP Forward or Backward buttons to tune to the desired station.



Auto tuning - Press the TUNING forward or backward buttons momentarily and release. The tuner will move forward or backward to the next available station.

Manual Tuning - Press and hold the SKIP forward/backward buttons until the display approaches your desired station. Then tap the buttons repeatedly until the display shows the exact frequency.

5. When finished listening, press the POWER button to shut the system OFF.

Note: For AM reception, plug the supplied frame antenna into the AM ANT jack. Then adjust the frame antenna until it is in position with the best reception.

STORING PRESET STATIONS

1. Tune to the station you wish to store.



The unit enables you to program 30 stations of FM and 10 stations of AM band.

2. Press the PROG button once, and the preset station number will be flashing.



3. Press the PRESET button repeatedly to set the desired preset station number.

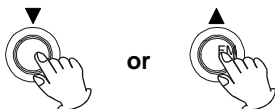

4. Press the PROG button again. The station is stored.



5. To store other stations, repeat above steps.

RECALLING PRESET STATION

Press the PRESET ▼▲ buttons to select the desired station.

Note: When setting or recalling the preset station by directly pressing the number, on remote control unit to press key number 0, 1 to preset station 01; press 0, 9 to preset station 09; press 1, 5 to preset station 15.

PLAYING COMPACT DISCS

1. Switch on the power and press the CD PLAY/ PAUSE button  to select the CD mode.
2. If there is no CD inside, a "NO DISC" display will appear.

When there is no disc

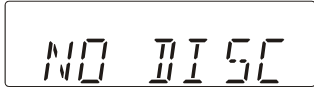

Loading a disc

1. Press the CD DOOR OPEN/CLOSE button to open the CD door.

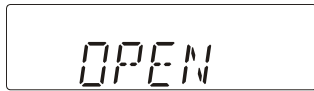

2. To load a disc, simply put the disc onto the center spindle of the player and then press the CD DOOR OPEN/CLOSE button again to close the CD door. After that, reading TOC will start.

Ensure that the disc is correctly mounted on the spindle and locked in place.

After reading TOC



The display will show the total number of tracks and the playing time of the disc.

Playing the disc ()

Press PLAY/PAUSE button to play the CD.

Playing track 1



Pause the playing ()

Press PLAY/PAUSE button while the disc is playing, the playing time will flash.

While paused

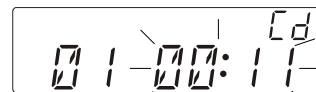

Press PLAY/PAUSE button again to resume.

Stopping the disc

Press STOP ()

Stop condition (TOC display)

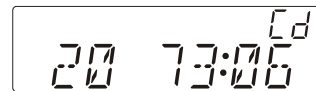



To operate by remote control

Select desired track by pressing 0-9, then press PLAY/PAUSE button to start playback.
Example: 03=Track 3, 11=Track 11.

Skip and Search Function

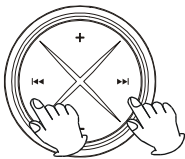
Press the SKIP Forward or Backward buttons momentarily during play mode or stop mode.



	IN PLAY MODE		IN STOP MODE
	PRESS ONCE	PRESS TWICE	PRESS ONCE
	BACK TO THE BEGINNING OF THE CURRENT TRACK	PREVIOUS TRACK	PREVIOUS TRACK
	NEXT TRACK		NEXT TRACK

Press and hold the SKIP button during playback:



: FAST BACKWARD



: FAST FORWARD

To repeat a track or disc

Press REPEAT button on remote control one time, "one track repeat" will be active. "REPEAT" shows on display.

One track repeat



With one more press, "all track repeat" will be active. "REPEAT ALL" shows on display.

All track repeat



With one further press, the repeat mode is cancelled.

Random play function

Press RANDOM button on remote control during CD play or stop mode to start random play. Pressing once again will cancel the function.

Random playing start



Note: Random play cannot operate while playing programmed tracks.

Intro play function

In the stop condition, press the INTRO button to start the intro playing. After that the first 10 seconds of each song will be played.

If the INTRO button is pressed again, the CD will change to normal playing mode.

Intro playing



PROGRAMMED PLAYBACK

The CD player enables you to program up to 64 tracks in a sequence of your choice. First select CD stop mode.

1. Press the PROG button one time.

Program input mode



2. Press the SKIP Forward or Backward buttons to select the desired track to be programmed. For example:



Choose track 4



3. Press PROG button again; then track 4 is stored.

4. Continue to program, repeat steps 2 and 3.

Reviewing programs

Press the PROG button repeatedly. The track number programmed on each program number will be displayed.

5. Press PLAY/PAUSE button to play the program tracks.

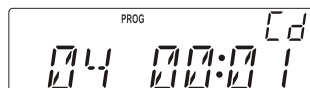

Note: If the program function has stopped, press the PROG button and then press the PLAY/PAUSE button, the program play will start.

Clear the program



In stop mode, press the PROG button one time and then press the STOP button. The preset programs will be cancelled.

PLAYING MP3 DISC

1. Switch on the power and press the CD PLAY/PAUSE  button to select the CD mode. Loading a MP3 disc.

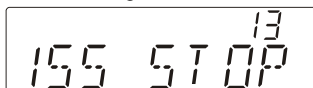
After reading TOC



2. Press the FOLDER  or  buttons to select desired album.



3. Press the SKIP  or  buttons to select desired track.



4. Press the PLAY/PAUSE button to play MP3.







Note: When MP3 is playing, press and hold MP3 MODE button about 2 seconds, the track no, title and artist information will be shown repeatedly in the display if disc information is available.

To resume normal play display, press and hold MP3 MODE button about 2 seconds.

Notice: Because of none-standardized format definition/production of MP3/CD playback quality & performance are not guaranteed. SANYO is not responsible for the playability of MP3 files due to recording conditions such as PC performance, writing software, media ability etc.

Album search (if disc information available)

1. Press the MP3 MODE button once, title name is displayed. (If no name is on the disc, NOTHING is displayed). Press SKIP  or  to select desired title from A to Z, 0 to 9, then press PLAY/PAUSE button to start playback.
2. Press the MP3 MODE button twice and ALBUM is displayed. (If no name is on the disc, UN_KNOWN is displayed). Press the SKIP  or  button to select desired album; then press the PLAY/PAUSE button to start playback.

To repeat a track or album

1. Press the REPEAT button on remote control once, MP3 plays one track repeatedly and REPEAT is displayed.

One track repeat



2. Press this button twice, MP3 plays all tracks repeatedly and REPEAT ALL is displayed.

All track repeat



3. Press this button three times, MP3 disc repeats the current playing album and ALBUM REPEAT displayed.

Album repeat



4. To cancel repeat function, Press REPEAT button on remote control repeatedly until repeat function display goes off.

Random play function

Press RANDOM button on remote control during playing or stop condition to start random play. Press once again to cancel the function.

Random playing start



Intro play function

During the stop condition, press the INTRO button to start the intro playing. After that the first 10 seconds of each song will be played. If the INTRO button is pressed again, the MP3 will change to normal playing mode.

Intro playing



PROGRAMMED PLAYBACK

The MP3 player enables you to program up to 64 tracks in a sequence of your choice. First select CD stop mode.

1. Press the PROG button once.



2. Press the SKIP **▶▶** or **◀◀** buttons to select your desired folder; for example folder 3.



3. Press the PROG button again.

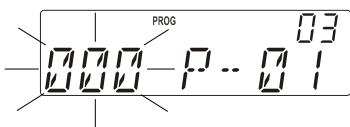

4. Press the SKIP **▶▶** or **◀◀** buttons to select your desired track, for example, track 10.

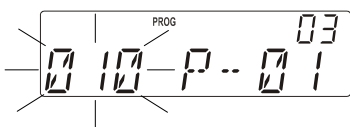

5. Press the PROG one more time, and track 10 of folder 3 is stored.



6. Continue to program, repeating steps 1 to 5.

Reviewing programs

Press the PROG button repeatedly. The track number programmed on each program number will be displayed.

7. Press PLAY/PAUSE button to play the program tracks.



Note: If the program already exit, function has already stopped ,press the PROG button and then press the PLAY/PAUSE button, the program play will start.

Clear the program

In the stop mode, press the PROG button one time and then press the STOP button, The preset programs will be cancelled or power off or open/close CD door cancelled.

iPod OPERATION

When connecting an iPod to this iPod Dock, please ensure that the correct removable insert is used.

iPod dock insert

This iPod Dock comes with 6 removable inserts.

To place a dock insert:







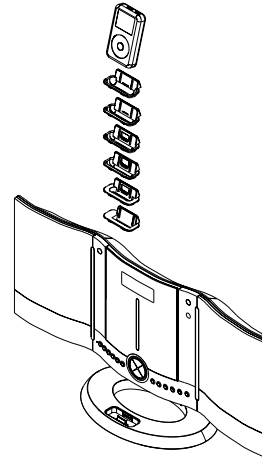





1. Refer to the compatibility table as that follows and select the correct dock insert for the iPod. Using the correct insert ensures the proper fit for your iPod. This can help to reduce the stress on the iPod dock connector when operating the iPod.
2. Carefully align and then gently insert the iPod into the dock. (The iPod must not be in a case or "skin").
3. To remove/replace an dock insert, remove the iPod first, then grip the insert and pull gently upwards.

Note: If iPod unit is PAUSE mode, the main console can't detect the iPod to play automatically once connected to the dock, Press the play key to play on the iPod.

- iPod could be operated directly to TV/Amplifier equipment when power off. The main console provides the operating power to the iPod.



Dock Insert Compatibility

		Photo 40 / 60GB 	20GB (Color)/ Photo 30GB 	mini 	nano 	40GB 	20GB 
		A	B	C	D	E	F
5G with Video 	30GB		X				
	60GB			X			
	80GB			X			
nano (1st generation) 	1GB				X		
	2GB				X		
	4GB				X		
nano (2nd generation) 	2GB				X		
	4GB				X		
	8GB				X		
photo 	20GB		X				
	30GB		X				
	40GB	X					
	60GB	X					
4G 	20GB						X
	40GB	X					
mini 	4GB			X			
	6GB			X			
3G 	10GB			X			
	15GB			X			
	20GB			X			
	30GB	X					
	40GB					X	

Charging your iPod

Please ensure you are using the correct insert for your iPod and it is properly docked.

FAILURE TO DO SO MAY CAUSE THE iPod can't charging result in its inability to charge.

Whilst the iPod is docked in the system, it will recharging (until fully charged) by power on the system unit. Once the iPod is removed from the dock, the main console will go to standby mode then turn off.

Note: there are no charging function while main console at power off mode.

Listening to your iPod

1. Insert the iPod.

2. With the main console power on, press the iPod PLAY/PAUSE button, "iPod" will show on the display.



3. Press iPod PLAY/PAUSE button to commence, control playback and stop.

4. For the iPod VIDEO, please connect with other external equipments from the pedestal AUDIO OUT RCA jacks (R/L) VIDEO OUT RCA jack.

NOTE: The volume control on the iPod is only for adjusting the volume of any headphones connected; it won't affect the volume control of the main console.

TROUBLESHOOTING GUIDE

Should this unit exhibit a problem, check the following before seeking service.

Symptom	Possible cause	Solution
Radio		
Noise or sound distorted on AM or FM broadcasts.	Station not tuned properly for AM or FM	Retune the AM or FM broadcast station.
	FM: Antenna wire is not extended.	Extend FM antenna wire.
	AM: Frame antenna is not positioned correctly.	Placed the frame antenna until best reception is obtained.
FM STEREO indicator does not light	FM MODE button is set to MONO position.	Set FM MODE to FM STEREO position.
AM or FM, no sound.	TUNER Function button is not pressed.	Press TUNER/BAND function button.
	Volume at minimum	Increase Volume level.
Compact Disc Player		
CD Player will not play.	CD Function button is not pressed.	Press the CD Function button.
	CD is not installed or installed incorrectly.	Insert CD with label side out.
CD skips while playing.	Disc is dirty or scratched.	Wipe disc with cloth or use another disc.
Disc is inserted but CD player skips over spot and will not play,	Disc inserted upside down.	Insert disc properly.
	Disc is dirty.	Clean disc.
	Disc is non-standard.	Use correct disc.
iPod Player		
Cannot insert the iPod.	The iPod dock insert is not correct.	Check the dock insert.
	There is dust or obstacles in the Dock.	Remove dust or obstacles from the Dock connector, and insert the iPod again.

If normal operation cannot be recovered, unplug the power cord from the outlet and plug it again.

SPECIFICATIONS

AC Power	AC 120V, 60Hz DC 3V (1.5V x 2 "AAA" batteries for tuner and clock memory). Batteries are not supplied.	CD Section	Vertical Front Loading CD
Power Output	5 W/CH 10% THD	Speaker System	Woofer: 4", 4 ohm Tweeter: 2", 4 ohm
Dimension of: Unit	619(W) x 200(D) x 315.5(H)mm	Remote Control	32 Keys, Battery size "CR2032" (Battery Included)
Radio section	Tuning : PLL with 40 Presets (FM 30, AM 10) Freq. Range : AM 520-1710KHz FM : 87.5-108MHz		

ACCESSORIES

Instruction manual	1 pc
iPod Insert	6 pcs
Remote control handset with battery	1 pc
AM loop antenna	1 pc
Wall mounting bracket for main console & speakers	3 pcs
Dowel & screw	6 pcs each
Bracket for speaker	2 pcs

WARRANTY

WARRANTY APPLICATION

New, unused SANYO Audio products purchased through a SANYO authorized dealer in Canada are warranted against manufacturing defects in materials and workmanship for **ONE YEAR** from the date of purchase by the original retail purchaser. This warranty only applies in favour of the original retail purchaser of the warranted product.

SANYO CANADA INC.'S RESPONSIBILITY

During the warranty period, SANYO Canada Inc. will repair, or at our option, replace an Audio product which shows evidence of a manufacturing defect in materials or workmanship. Replacement PARTS are warranted for the remaining portion of the warranty period.

WHAT IS NOT COVERED

- (a) Audio products purchased outside Canada.
- (b) Audio products purchased in a used condition.
- (c) Problems due to product set up and installation.
- (d) Adjustments that are outlined in the Operating Manual.
- (e) Accessory items including antenna, batteries.
- (f) Damage in or due to transportation.
- (g) Damage due to improper maintenance, improper wiring, accident, abuse, misuse or negligence.
- (h) Damage caused by lightning and power surges.
- (i) The cost of removal and reinstallation of an Audio product designed for automobile use.

ORIGINAL RETAIL PURCHASER'S RESPONSIBILITY

You, the original retail purchaser, must present your original, dated bill of sale together with this warranty to SANYO Canada Inc. or to an authorized SANYO Service Depot when you make a claim under this Warranty. You, the original retail purchaser, are responsible for any costs of TRANSPORTING the product to and from SANYO Canada Inc. or an authorized SANYO Service Depot.

You also are responsible for the cost of any MAINTENANCE necessary in respect of the product.

WARRANTY BECOMES VOID

This warranty becomes void if the product's serial numbers are altered or removed or if any repair to the product is made other than by SANYO Canada Inc. or by an authorized SANYO Service Depot.

LIMITATIONS

- (a) SANYO Canada Inc. reserves the right to change or improve the design of the model of the product warranted hereunder without incurring any obligation to make any modifications to or to install any improvement in or on the product.
- (b) In no event shall SANYO Canada Inc. or any of its Authorized Dealers be liable for special or consequential damage arising from the use of this product.

STATUTORY WARRANTIES

The above provisions do not preclude the operation of any applicable provincial statute which in certain circumstances may not allow some of the limitations and exclusions described in this Warranty. Where any terms of this Warranty are prohibited by such a statute, they shall be deemed null and void but the remainder of this warranty shall remain in effect.

HOW TO OBTAIN WARRANTY SERVICE

Please contact the SANYO Authorized Dealer from whom the product was purchased, or contact us directly at:

SANYO Canada Inc.
1-300 Applewood Cres.
Concord, Ontario
L4K 5C7
1-800-263-2244
www.sanyo.ca

SANYO

SANYO Canada Inc.
Printed in China

Free Manuals Download Website

<http://myh66.com>

<http://usermanuals.us>

<http://www.somanuals.com>

<http://www.4manuals.cc>

<http://www.manual-lib.com>

<http://www.404manual.com>

<http://www.luxmanual.com>

<http://aubethermostatmanual.com>

Golf course search by state

<http://golfingnear.com>

Email search by domain

<http://emailbydomain.com>

Auto manuals search

<http://auto.somanuals.com>

TV manuals search

<http://tv.somanuals.com>