

SANYO



Split System Heat Pump

INSTRUCTION MANUAL

KHS0921
KHS0922
KHS1222
KHS1822
KHS2422

Save These Instructions!

Pub. OI-85264179346005

Contents

Product Information.....	2
Alert Symbols	2
Installation Location	3
Electrical Requirements.....	3
Safety Instructions	3
Names of Parts	4
Using the Remote Control Unit.....	8
Operation with the Remote Control Unit	9
1. Cooling	9
2. Adjusting the Fan Speed	10
3. Fan Only.....	11
4. Heating.....	12
Operation without the Remote Control Unit	13
Setting the Timer	14
Adjusting the Airflow Direction.....	15
Care and Cleaning	16
Troubleshooting.....	17
Tips for Energy Saving.....	17
Operating Range.....	17

Product Information

If you have problems or questions concerning your Air Conditioner, you will need the following information. Model and serial numbers are on the name plate on the right side of the cabinet.

Model No. _____ Serial No. _____
Date of purchase _____
Dealer's address _____
Phone number _____

Alert Symbols

The following symbols used in this manual, alert you potentially dangerous conditions to users, service personnels or the appliance:



This symbol warns of immediate hazards which will result in severe personal injury or death. This symbol will be used in an extreme case.



This symbol refers to a hazard or unsafe practice which can result in severe personal injury or death.



This symbol refers to a hazard or unsafe practice which can result in personal injury or product or property damage.

Installation Location

- We recommend that this air conditioner must be installed properly by a qualified installation technician in accordance with the Installation Instructions provided with the unit.
- Before installation, check that the voltage of the electric supply in your home or office is the same as the voltage shown on the nameplate.



WARNING:



Avoid:

- Do not install this air conditioner where there are fumes or flammable gases, or in an extremely humid space such as a green house.
- Do not install the air conditioner where excessively high heat-generating objects are places.
- To protect the air conditioner from heavy corrosion, avoid installing the outdoor unit where salty sea water can splash directly onto it or in sulphurous air near a spa.

Electrical Requirements

1. All wiring must conform to the local electrical codes. Consult your dealer or a qualified electrician for details.
2. Each unit must be properly grounded with a ground (or earth) wire or through supply wiring.
3. Wiring must be done by a qualified electrician.



CAUTION:

Power mains

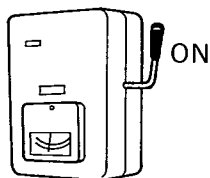

To warm up the system, power mains must be turned on at least five (5) hours before operation. Leave the power mains ON unless you will not be using this appliance for an extended period.

- Power supply: 60 Hz, single-phase

KHS□□21	115 VOLT
KHS□□22	230/208 VOLT

Safety Instructions

- Read this booklet carefully before using this air conditioner. If you still have any difficulties or problems, consult your dealer for help.
- This air conditioner is designed to give you comfortable room conditioners. Use this only for its intended purpose as described in these Instruction Manual.



WARNING:

- Never use or store gasoline or other flammable vapor or liquid near the air conditioner — it is very dangerous.
- This air conditioner has no ventilator for intaking fresh air from outdoors. You must open doors or windows frequently when you use gas or oil heating appliances in the same room, which consume a lot of oxygen from the air. Otherwise there is a risk of suffocation in an extreme case.



CAUTION:

- Do not turn the air conditioner on and off from the power mains switch. Use the operation ON/OFF button.
- Do not stick anything into the air outlet of the air conditioner. This is dangerous because the fan is rotating at high speed.
- Do not let children play with the air conditioner.
- Do not cool or heat the room too much if babies or invalids are present.

Names of Parts

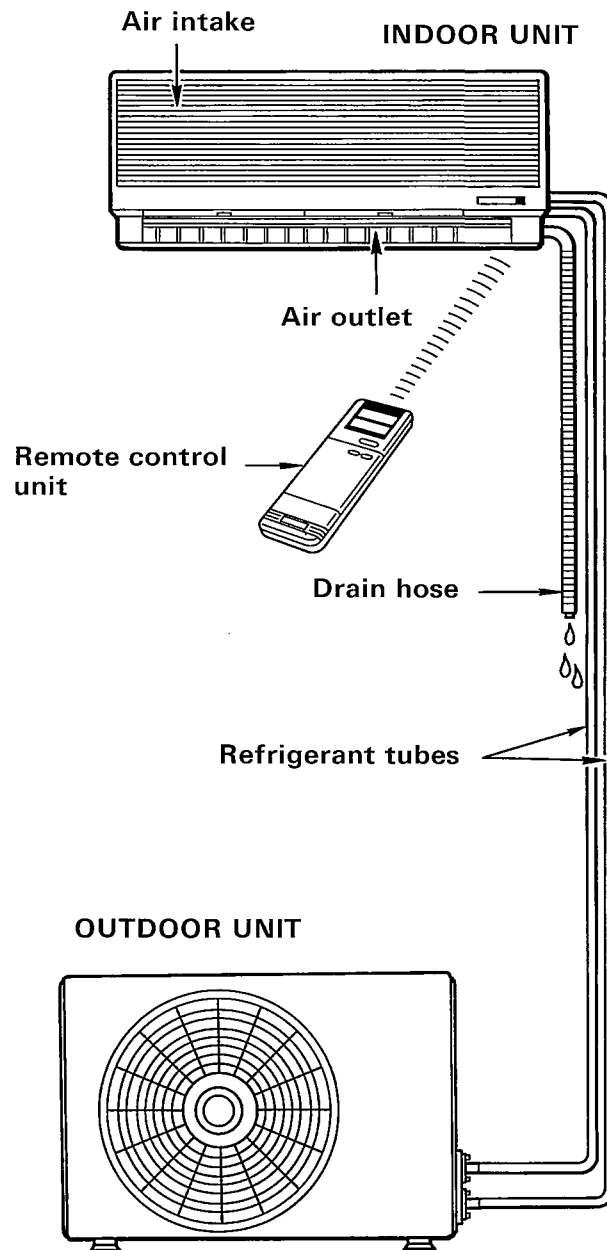

NOTE:

This illustration is based on the external view of a standard model. Consequently, the shape may differ from that of the air conditioner which you have selected.

This air conditioner consists of an indoor unit and an outdoor unit. You can control the air conditioner with the remote control unit.

Air Intake

Air from the room is drawn into this section and passes through air filters which remove dust.

Air Outlet

Conditioned air is blown out of the air conditioner through the air outlet. The wireless remote control unit controls power ON/OFF, operation mode selection, temperature, fan speed, timer setting, and air sweeping.

Remote Control Unit

The indoor and outdoor units are connected by copper tubes through which refrigerant gas flows.

Refrigerant Tubes

Drain Hose

Moisture in the room condenses and drains off through this hose.

Outdoor (Condensing) Unit

The outdoor unit contains the compressor, fan motor, heat exchanger coil, and other electrical components.

Unit Display and Operation Selector

INDOOR UNIT

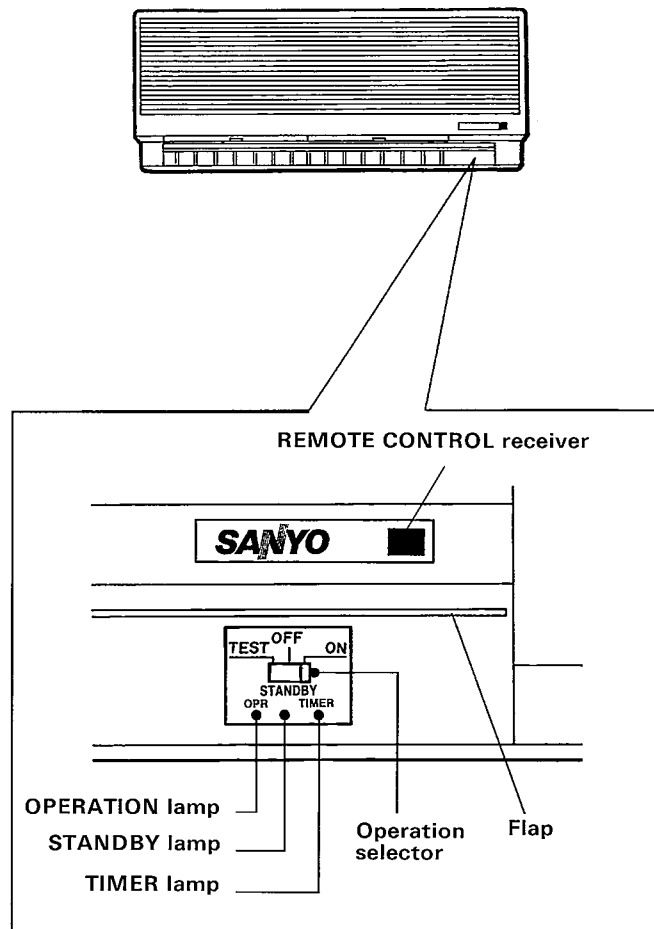

REMOTE CONTROL receiver

This section picks up infrared signals from the remote control unit (transmitter).

OPERATION lamp

This lights when the system is in the continuous COOL or FAN mode.

STANDBY lamp

This lamp lights during warm up period for heating and when the system is defrosting. To keep a constant room temperature, the air conditioner continues to supply a gentle breeze during warm up or when the heating operation is paused by the thermostat.

TIMER lamp

This lamp lights when the system is being controlled by the timer.

Operation selector

ON position

This position is for operating the air conditioner with the wireless remote control unit. Set the selector normally in this position.

OFF position

Switch the selector to the OFF position if you are not going to use the air conditioner for a few days or longer.



WARNING:

The OFF position does not disconnect the power. Use the main power switch to turn off power completely.



CAUTION:

TEST position

This position is used only when servicing the air conditioner, so don't leave the selector in this position.

Remote Control Unit

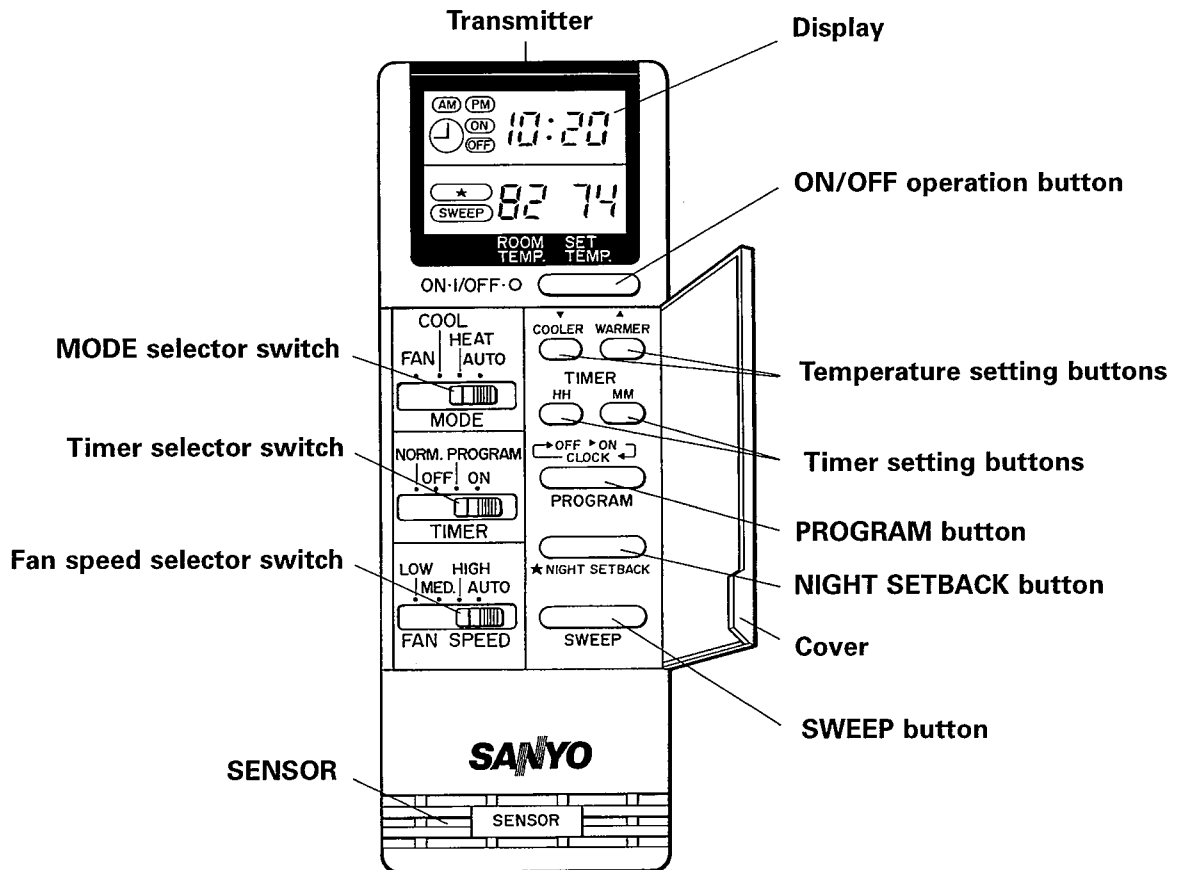

Transmitter

When you press the buttons or move the switches on the remote control unit, the lamp at the tip of the unit flashes to transmit the setting changes to the receiver in the air conditioner.

Display

Information is displayed while the remote control unit is switched on. The display shows the time and the room temperature at the remote control unit when the unit is switched off.

ON/OFF operation button

This button is for turning the air conditioner on and off.

Cover

The cover opens from the left. Just pull it open.

Temperature setting buttons

Press "COOLER" button to change the set temperature down. Press "WARMER" button to change the set temperature up.



NOTE:

You can press the temperature setting buttons keeping the cover closed.

Timer setting buttons

First, press the PROGRAM button to select the mode you want. Each time you press "HH" button, the hours advance by one. Each time you press "MM" button, the minutes advance by one.

PROGRAM button

For details, see "Setting the Timer". Press this button to select the mode you want to program.

NIGHT SETBACK button

For details, see "Night Setback Mode". When you press this button in the COOL mode, the  mark appears at the lower left of the display, and the remote control unit will automatically adjust the set temperature to save energy.

Remote Control Unit (continued)

SWEEP button

When you press this button, the **SWEEP** mark will appear at the lower left of the display, and the flap in the air outlet starts moving up and down to deliver air over the sweep range set. To stop sweeping, just press the SWEEP button again.



NOTE:

SWEEP button is not provided with the following models: **KHS0921** and **KHS0922**

MODE selector switch

FAN: The air conditioner works only as a circulation fan.
COOL: The air conditioner makes the room cooler.
HEAT: The air conditioner makes the room warmer.
AUTO: When this setting is selected, the air conditioner calculates the difference between the thermostat setting and the room temperature and automatically switches to the "cool" or "heat" mode as appropriate.

Timer selector switch

NORM.: The timer does not operate.
OFF: The air conditioner stops at the set time.
ON: The air conditioner starts at the set time.
PROGRAM: The air conditioner stops and starts, or starts and stops, at the set times every day.

Fan speed selector switch

AUTO: The air conditioner automatically decides the fan speeds.
HIGH: High speed for fast cooling
MED.: Medium speed
LOW: Low speed

SENSOR

A temperature sensor inside the remote control unit senses the room temperature.

Using the Remote Control Unit

How to Install Batteries

Slide to open →

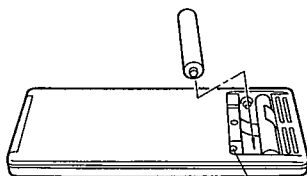
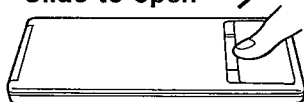

ACL button



NOTE:

1. Press and slide the lid on the back of the remote control unit in the direction of the arrow.
2. Install two AAA alkaline batteries. Make sure the batteries point in the direction marked in the battery compartment.
3. Press the ACL button, then replace the lid. If you press it, the current time, ON time, and OFF time are all reset to 12:00. This may make it easier for you to reset those times. (See "Setting the Timer".)

- The batteries last about six months, depending on how much you use the remote control unit. Replace the batteries when the remote control unit's lamp fails to light, or when the remote control cannot be used to change the air conditioner's settings.
- Use two fresh leak-proof type-AAA alkaline batteries.
- In replacing batteries, follow the instructions as mentioned in the sub-section "How to Install Batteries".
- If you do not use the remote control unit more than 1 month, take out the batteries.

How to Use the Remote Control Unit

When using the remote control unit, always point the unit's transmitter head directly at the air conditioner's receiver.

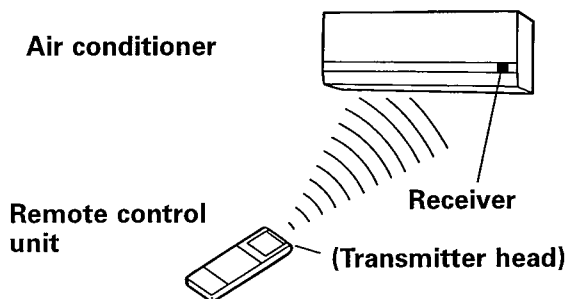

Remote Control Unit Installation Position

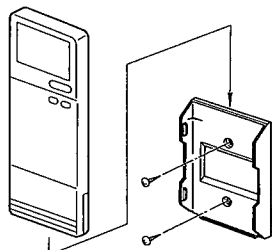
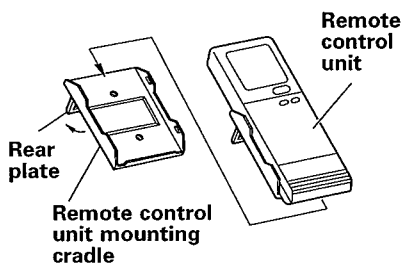

The indoor remote unit may be operated either from a non-fixed position or from a wall-mounted position. To ensure that the air conditioner operates correctly, do not install the remote control unit in the following places:

- In direct sunlight
- Behind a curtain or other places where it is covered
- More than 26 ft. away from the air conditioner
- In the path of the air conditioner's airstream
- Where it may become extremely hot or cold
- Where it may be subject to electrical or magnetic noise

1. If Non-fixed Position

Raise the rear plate of the remote control unit mounting cradle and insert the remote control unit. The unit can be used either in that position (placed on a table, for instance) or held in the hand.

2. If Wall-mounted Fixed Position

Install the remote control unit at a convenient location on a nearby wall. However, before attaching the remote control unit mounting cradle, check that the remote control unit can operate from the desired wall position.

Operation with the Remote Control Unit

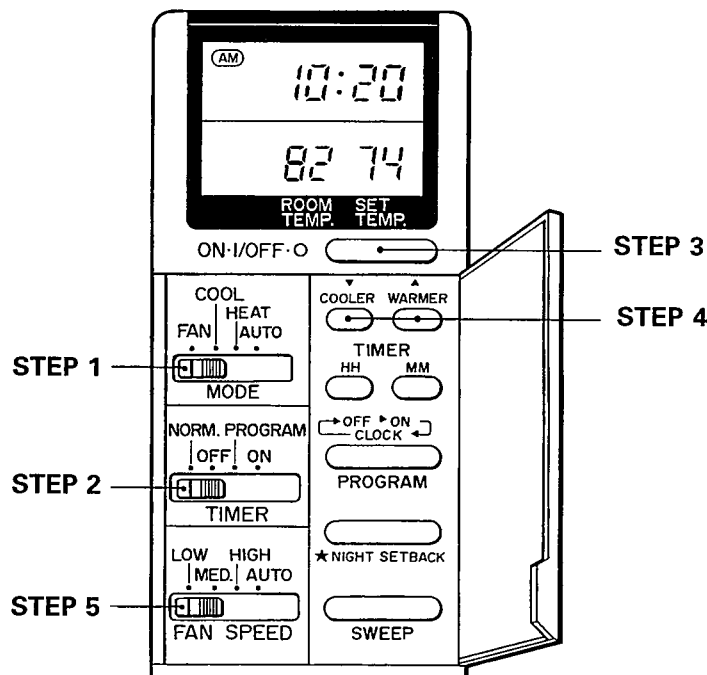

NOTE:

1. Cooling

Check that the circuit breaker on the power panel is turned on and the operation selector of the indoor unit is in the ON position.

- STEP 1:** Set the MODE selector switch to COOL.
STEP 2: Set the timer selector switch to NORM.
STEP 3: Press the ON/OFF operation button.
STEP 4: Press the COOLER or WARMER button to set a cooler or warmer temperature.
 Each time you press these buttons, the set temperature varies by 2°F.
 84°F max.
 64°F min.
- STEP 5:** Set the fan speed selector switch to the setting you want.

To stop the air conditioner, press the ON/OFF operation button again.



NOTE:

- Choose the best position in the room for the remote control unit, which also acts as the sensor for room comfort and transmits the operating instructions. Once you've found this best position, always keep the remote control unit there.
- This appliance has a built-in 3-minute time delay circuit to ensure reliable operation. If the operation button is pressed, the compressor will start running after three minutes. In the event of power failure, the unit will stop. When the power is applied, the unit will re-start automatically after 3 minutes.



CAUTION:

- To prevent the appliance from malfunctioning, do not set any selector switch between two indicated positions. Make sure that it clicks into position.

Operation with the Remote Control Unit (continued)



CAUTION:

If the outdoor temperature is too cool:

When the outdoor temperature stays at around 59° F, the air conditioner suspends the cooling operation and the STANDBY (orange) lamp keeps on flashing.

When it becomes warmer, the air conditioner automatically resumes the cooling operation.

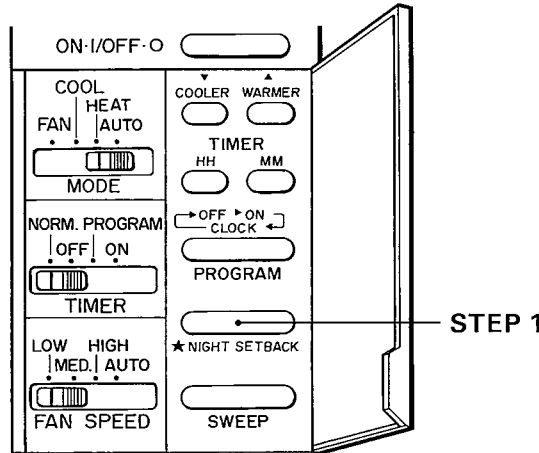

Night Setback Mode in Cooling

STEP 1: Press the NIGHT SETBACK button in cooling. The  mark appears at the lower left of the display. Press the NIGHT SETBACK button again to release the night setback function. This button has no effect in the FAN mode.

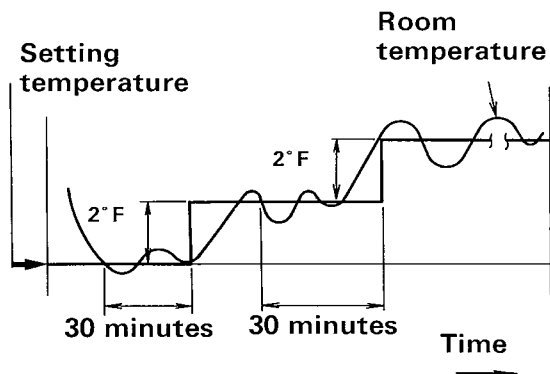

What does the Night Setback mode mean?

In this mode, the air conditioner will cool the room to the set temperature, and then the thermostat will make the unit pause. After about 30 minutes, the air conditioner will automatically raise the set temperature by 2° F. When the room temperature reaches the newly set value, the thermostat will cause the unit to pause. After about 30 minutes the temperature will again be raised by 2° F. This enables you to save energy without sacrificing comfort. This function is convenient when gentle cooling is needed.

2. Adjusting the Fan Speed

A. Automatic

STEP 1: Simply set the FAN SPEED selector to the "AUTO" position.

A microcomputer in the air conditioner automatically controls the fan speed when the AUTO mode is selected. When the air conditioner starts operating, the difference between the room temperature and the set temperature is detected by the microcomputer which then automatically switches the fan speed to the most suitable level.

Operation with the Remote Control Unit (Continued)

Cooling mode:

When difference between room temperature and set temperature is	FAN SPEED
4°F and over	High
Between 4°F and 2°F	Medium
Below 2°F	Low

Heating mode:

When difference between room temperature and set temperature is	FAN SPEED
2°F and over	High
Below 2°F	Medium

B. Manual

If you want to adjust fan speed manually during cooling, just set the FAN SPEED selector as desired. [HIGH, MED., or LOW]

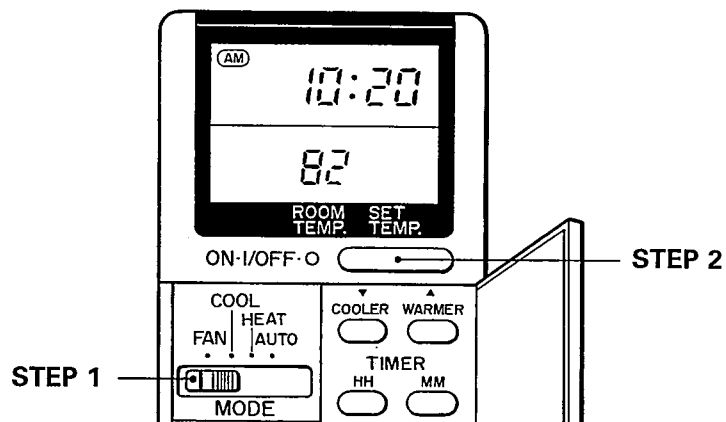

3. Fan Only

If you want to circulate air without any temperature control, follow these steps:

- STEP 1:** Set the MODE selector switch to FAN.
STEP 2: Press the ON/OFF operation button.

Operation with the Remote Control Unit (Continued)

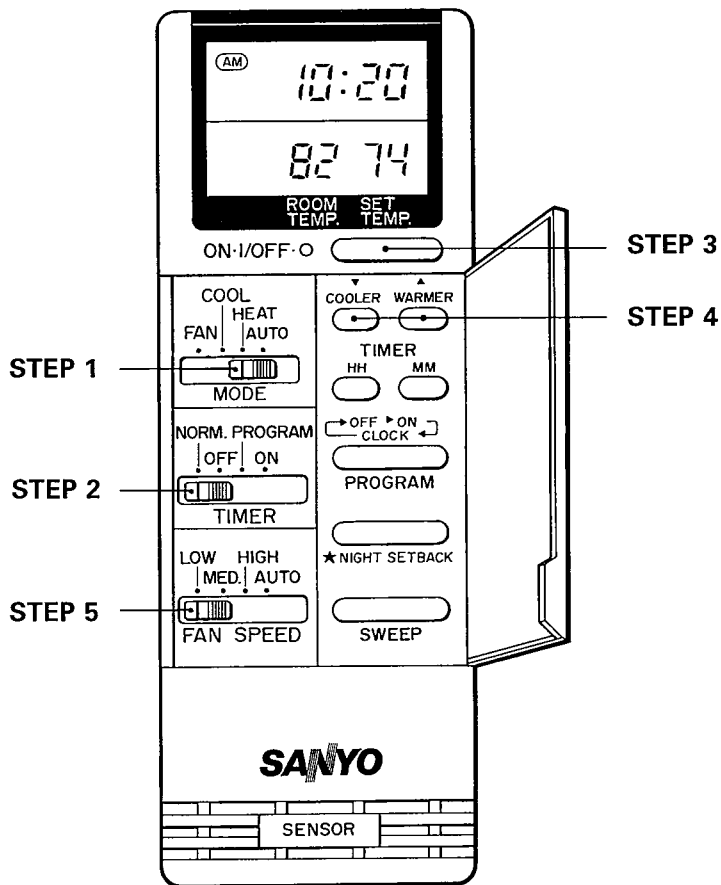

4. Heating

- STEP 1:** Set the MODE selector switch to HEAT.
- STEP 2:** Set the timer selector switch to NORM.
- STEP 3:** Press the ON/OFF operation button.
- STEP 4:** Press the COOLER or WARMER button to set a cooler or warmer temperature.
Each time you press these buttons, the set temperature varies by 2°F.
84°F max.
64°F min.
- STEP 5:** Set the fan speed selector switch to the setting you want. To stop the air conditioner, press the ON/OFF operation button again.



NOTE:

- Choose the best position in the room for the remote control unit, which also acts as the sensor for room comfort and transmits the operating instructions. Once you've found this best position, always keep the remote control unit there.
- This appliance has a built-in 3-minute time delay circuit to ensure reliable operation. If the operation button is pressed, the compressor will start running after three minutes. In the event of power failure, the unit will stop. When the power is applied, the unit will re-start automatically after 3 minutes.



CAUTION:

- To prevent the appliance from malfunctioning, do not set any selector switch between two indicated positions. Make sure that it clicks into position.

**CAUTION:**

If the outdoor temperature is extremely low, it is recommended to use another heating appliance:
When the outdoor temperature falls to around 10° F, the compressor stops. In this case, to prevent room from freezing, use another heating appliance.

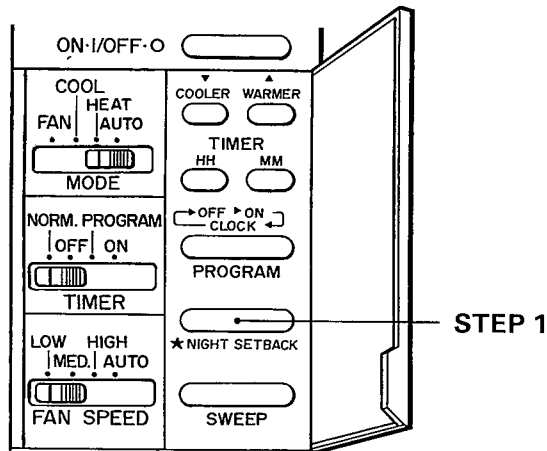

Night Setback Mode in Heating

STEP 1: Press the NIGHT SETBACK button in cooling.
The mark appears at the lower left of the display. Press the NIGHT SETBACK button again to release the night setback function. This button has no effect in the FAN mode.

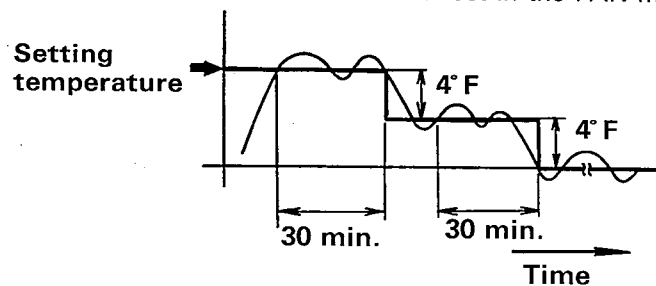

What does the Night Setback mode mean?

In this mode, the air conditioner will heat the room to the set temperature, and then the thermostat will make the unit pause. After about 30 minutes, the air conditioner will automatically lower the set temperature by 4° F. When the room temperature reaches the newly set value, the thermostat will cause the unit to pause. After about 30 minutes the temperature will again lowered by 4° F. This enables you to save energy without sacrificing comfort. This function is convenient when gentle heating is needed.

Operation without the Remote Control Unit

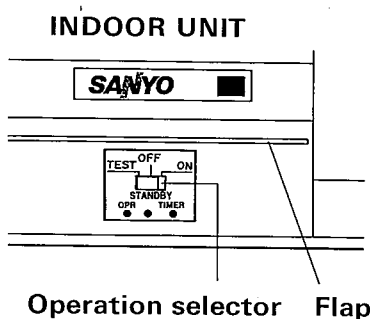

If you have lost the remote control unit or it has trouble, follow the steps below.

1. When the air conditioner is stopped.

If you want to turn on the air conditioner, switch the operation selector to the OFF position, and then to the ON position.

**NOTE:**

The set temp. and fan speed are automatically set at the latest selection before stopping.

2. When the air conditioner is running.

If you want to turn off the air conditioner, switch the operation selector to the OFF position.

Setting the Timer

1) How to set the present time

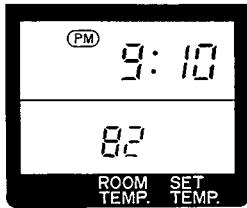

(Example) To set to 9:10 p.m.

Operation	Indication
1. Press the PROGRAM button three times. The time indication alone flashes.	Flashing
2. <ul style="list-style-type: none"> Press the HH button until 9 and (PM) are displayed. Press the MM button until 10 is displayed. The display will automatically stop flashing except for the ":" symbol after 10 sec. 	Flashing

2) How to set the OFF time

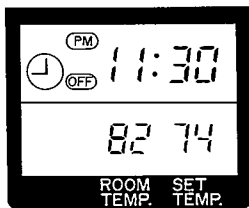

(Example) To stop the air conditioner at 11:30 p.m.

1. Press the PROGRAM button once. The timer OFF and time indications flash.	Flashing
2. <ul style="list-style-type: none"> Press the HH button until 11 is displayed. Press the MM button until 30 is displayed. The display will change automatically back to show the present time after 10 sec. 	Flashing
3. Set the timer switch(es) to OFF.	
4. Press the ON/OFF button to start the air conditioner.	

3) How to set the ON time

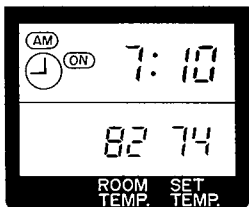

(Example) To start operation at 7:10.

1. Press the PROGRAM button twice. The timer ON and time indications flash.	Flashing
2. <ul style="list-style-type: none"> Press the HH button until 7 and (AM) are displayed. Press the MM button until 10 is displayed. The display will change automatically back to show the present time after 10 sec. 	Flashing
3. Set the timer switch(es) to ON.	
4. Press the ON/OFF button to start the air conditioner.	

4) How to set for daily ON/OFF operation

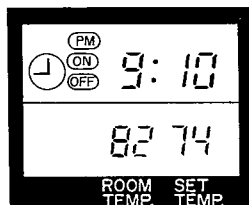

(Example) To start operation at 7:10 and stop the air conditioner at 11:30 p.m.

1. Set the timer ON/OFF times as shown in 2) and 3).	
2. Set the timer switch(es) to PROGRAM.	
3. Press the ON/OFF button to start the air conditioner.	

**NOTE:****Power failure during timer operation**

If power failure occurs, the time counted up to that point will become void. After the power is applied, the timer newly starts counting at the set time.

Adjusting the Airflow Direction

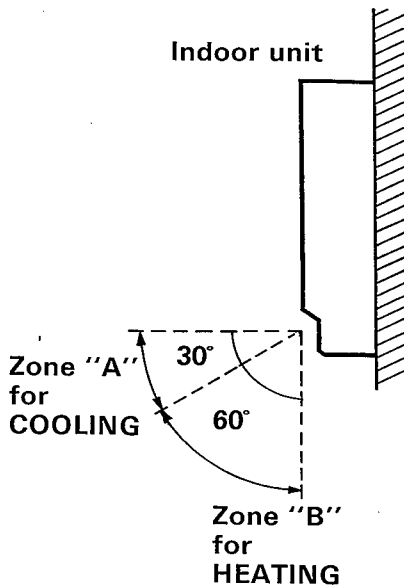
**A. Horizontal**

The horizontal airflow can be adjusted by moving the vertical vane to the left or right.

B. Vertical

Confirm that the remote control unit has been turned on. Press the SWEEP button to start the flap moving up and down. If you want to stop the flap movement and to direct the air in the desired direction, press the SWEEP button again. In the COOL mode, don't direct the flap down more than 30° otherwise, condensation may drip on to the floor. Zone "A" is the recommended flap position for cooling.

**NOTE:**

KHS0921 and KHS0922 models:

Since SWEEP button is not provided with above mentioned models, you can manually move the flap to desired position.

**CAUTION:**

Do not move the flap with your hands.

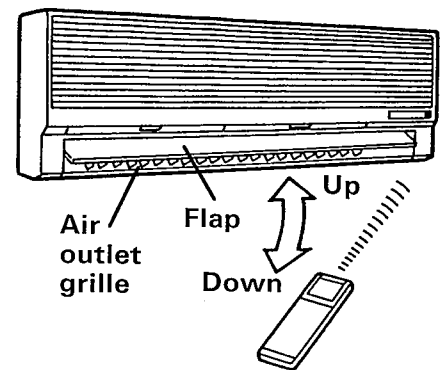
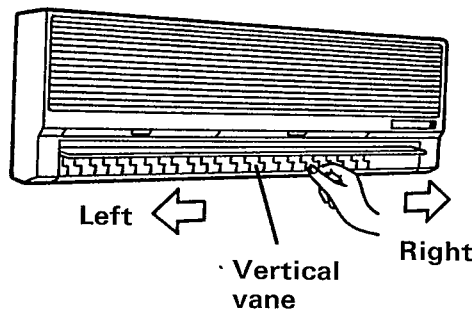

Care and Cleaning



WARNING:

1. For safety, be sure to turn the air conditioner off and also to disconnect the power before cleaning.
2. Do not pour water on the indoor unit to clean it. This will damage the internal components and cause an electric shock hazard.

Casing and Grille (Indoor Unit)

Clean the casing and grille of the indoor unit with a vacuum cleaner brush, or wipe them with a clean, soft cloth.

If these parts are stained, use a clean cloth moistened with a mild liquid detergent. When cleaning the grille, be careful not to force the vanes out of place.



CAUTION:

1. Never use solvents, or harsh chemicals when cleaning the indoor unit. Do not wipe the plastic casing using very hot water.
2. Some metal edges and the fins are sharp and may cause injury if handled improperly; be especially careful when you clean these parts.
3. The internal coil and other components of the outdoor unit must be cleaned every year. Consult your dealer or service centre.

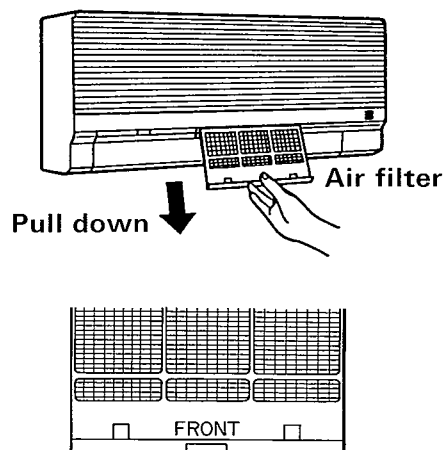

Air Filter

The air filter behind the air intake grille should be checked and cleaned at least once every two weeks.

How to remove the filter

1. Move the flap on the air outlet grille to its lowest position.
2. Hold the air filter by the tab at the bottom, and pull downward.

Use a vacuum cleaner to remove light dust. If there is sticky dust on the filter, wash the filter in lukewarm, soapy water, rinse it in clean water, and dry it. When replacing the filter, make sure that the FRONT mark is facing you.

Troubleshooting

If your air conditioner does not work properly, first check the following points before requesting service. If it still does not work properly, contact your dealer or service centre.

Trouble	Possible Cause	Remedy
Air conditioner does not run at all	<ol style="list-style-type: none"> 1. Power failure 2. Leakage breaker tripped 3. Line voltage too low 4. Operation button is OFF 5. Batteries in remote control unit have run down 	<ol style="list-style-type: none"> 1. Restore power 2. Contact service centre 3. Consult with electrician or dealer 4. Press the button again 5. Replace batteries
Compressor runs but soon stops	<ol style="list-style-type: none"> 1. Obstruction in front of condenser coil 	<ol style="list-style-type: none"> 1. Remove obstruction
Poor cooling (or heating) performance	<ol style="list-style-type: none"> 1. Dirty or clogged air filter 2. Heat source or many people in room 3. Doors and/or windows are open 4. Obstacle near air intake or air discharge port 5. Thermostat is set too high for cooling (or too low for heating) 6. (Outdoor temperature is too low) 7. (Defrosting system does not work) 	<ol style="list-style-type: none"> 1. Clean air filter to improve airflow 2. Eliminate heat source if possible 3. Shut them to keep the heat out 4. Remove it to ensure good airflow 5. Set the temperature lower 6. (Try to use any back-up heater) 7. (Consult your dealer)

Tips for Energy Saving

Do not:

- **Block the air intake and outlet of the unit. If it is obstructed, the unit will not work well, and may be damaged.**
- Let direct sunlight into the room. Use sunshades, blind or curtains. If the walls and ceiling of the room are warmed by the sun, it will take longer to cool the room.

Do:

- Always try to keep the air filter clean. (Refer to "Care and Cleaning"). A clogged filter will impair the performance of the unit.
- To prevent conditioned air from escaping, keep windows, doors and any other openings closed.

Operating Range

	Temperature	Indoor air intake	Outdoor air intake
Cooling	Maximum	95° F DB/- 71° F WB	115° F DB
	Minimum	67° F DB/- 57° F WB	67° F DB
Heating	Maximum	80° F DB/- 67° F WB	75° F DB/- 65° F WB
	Minimum	— DB/- — WB	17° F DB/- 15° F WB

**SANYO FISHER COMPANY
A DIVISION OF SANYO NORTH AMERICA CORPORATION
21605 Plummer Street
Chatsworth, CA 91311 U.S.A.**

**In Canada
SANYO Canada Inc.
300 Applewood Crescent,
Concord, Ontario,
L4K 5C7, Canada**

Free Manuals Download Website

<http://myh66.com>

<http://usermanuals.us>

<http://www.somanuals.com>

<http://www.4manuals.cc>

<http://www.manual-lib.com>

<http://www.404manual.com>

<http://www.luxmanual.com>

<http://aubethermostatmanual.com>

Golf course search by state

<http://golfingnear.com>

Email search by domain

<http://emailbydomain.com>

Auto manuals search

<http://auto.somanuals.com>

TV manuals search

<http://tv.somanuals.com>