



FILE NO.

**SERVICE MANUAL
SUPPLEMENT**

Microwave Oven

EM-G5595S
(Color : Black)
PRODUCT CODE No.
1 437 648 16

The original service manual is EM-S5595S.

This supplement is intended to add EM-G5595S to the original service manual of EM-S5595S black (120V/60Hz/U3, Prod. code 1 437 648 13) version.

Please refer to original service manual of EM-S5595S (SM0911002) for the other items.

REF.NO.	ORIGINAL MODEL EM-S5595S, BLACK COLOR 1 437 648 13 (120V/60Hz/U3)	SUPPLIMENT MODEL EM-S5595S EM-G5595S, BLACK COLOR 1 437 648 16 (120V/60Hz/U3)	DESCRIPTION
1	MM251502600195	MM251502600316	Cabinet
2	MM251202800340	MM251202800436	Wire assy
9	MM251400300134	MM251400300684	Noise Filter
10	MM251201300649	MM251201300704	Thermostat
14	MM252100500015	MM252100500500	Turntable
15	MM251400100485	MM251400100486	PCB assy
17	 MM251201000175	MM251201000194	Power Cord
18	MM251500100734	MM251500300059	Cavity assembly
23	MM251300102291	MM251300101074	Door frame
24	MM251400200850	MM251300202210	Touch pad
28	MM251501400049	MM251501400577	Base plate
40	MM251200900599	MM251200900021	H.V. diode
43	MM251508900480	MM251508900016	Door S.S. flake-top
44	MM251509000522	MM251509000917	Door S.S. flake-left
45	MM251509100521	MM251509100919	Door S.S. flake-left
47	-----	MM251501000008	Quartz tube plate
48	-----	MM251502700020	Top grill cover
49	-----	MM251200400028	Quartz tube
50	-----	MM251505700000	Heat insulator

REFERENCE No. SS0911002

CIRCUIT DIAGRAM

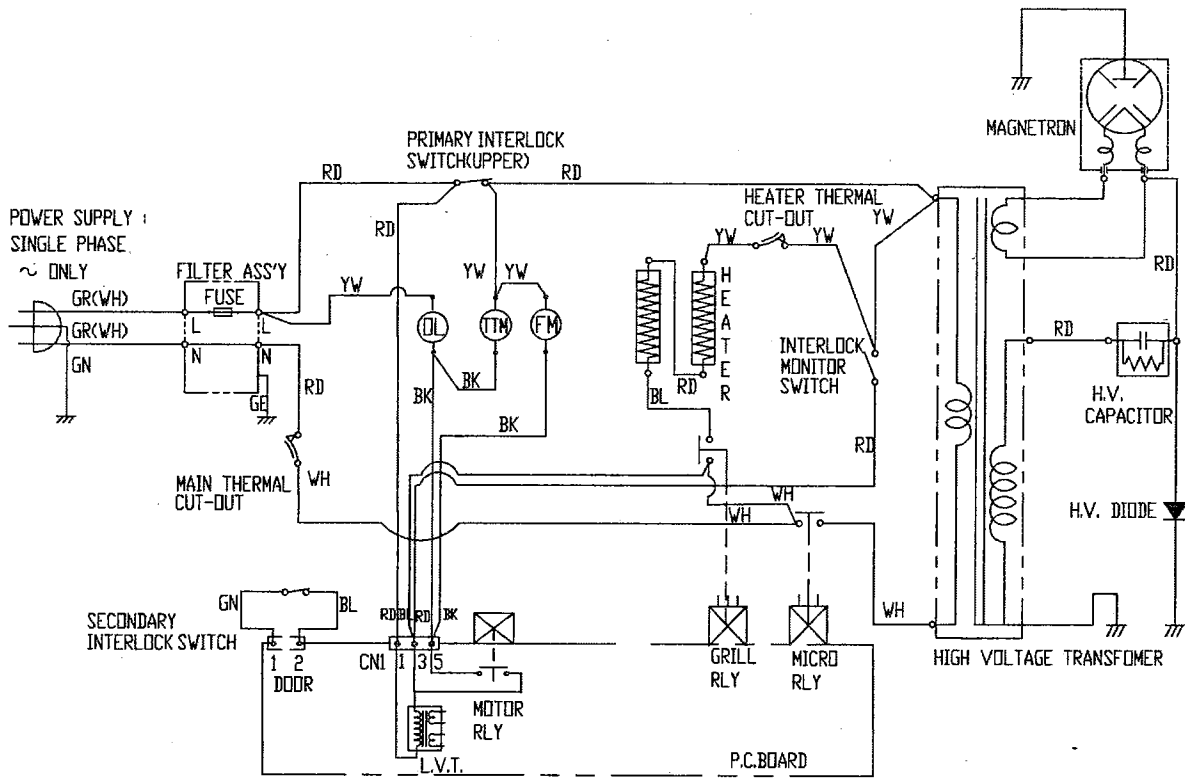

NOTE : RD : RED GN : GREEN DL : OVEN LAMP [CONDITION]
 WH : WHITE BL : BLUE FM : FAN(BLOWER) MOTOR DOOR : CLOSED
 BK : BLACK GR : GRAY TTM : TURN TABLE MOTOR COOK : OFF
 GE : GREEN/YELLOW

EXPLODED VIEW (Additional Parts)

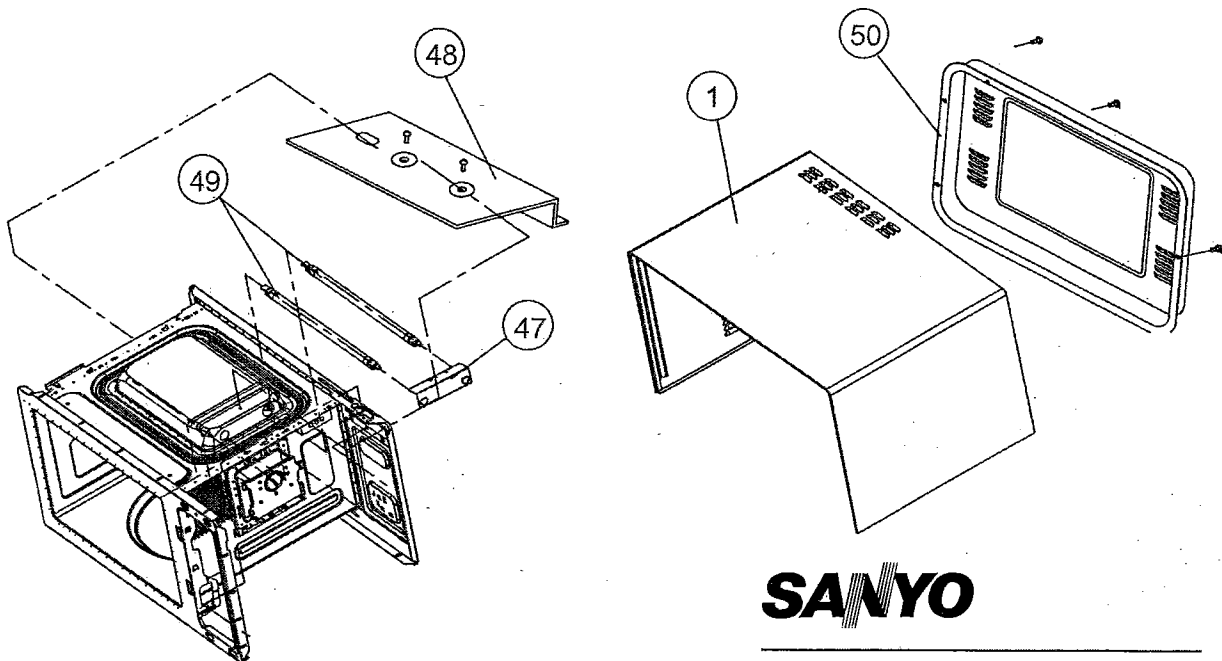

SANYO

SANYO Electric Co., Ltd.
Osaka, Japan

FILE NO.

SERVICE MANUAL

Microwave Oven

EM-S5595S

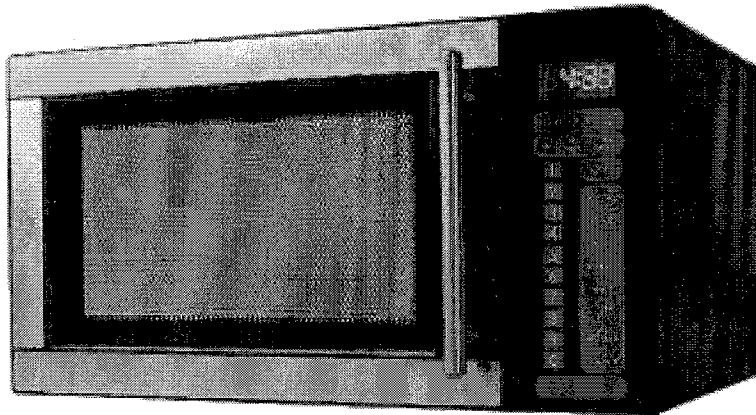

SPECIFICATIONS

Power source: 120V / 60Hz

Power consumption: 1450W

Dimension: 511(W) x 283(H) x 427(D)mm

Net Weight: Approx. 15.1kg

Specifications subject to change without notice

Product Code	Model	Suffix	V/Hz/Plug	Color	Function	Cavity Volume	Control Panel	Destination
1 437 648 13	EM-S5595S	FC	120V/60Hz/U3	Black	Touch	25L,0.8Cu.ft	English	USA

REFERENCE No. SM0911002

CIRCUIT DIAGRAM

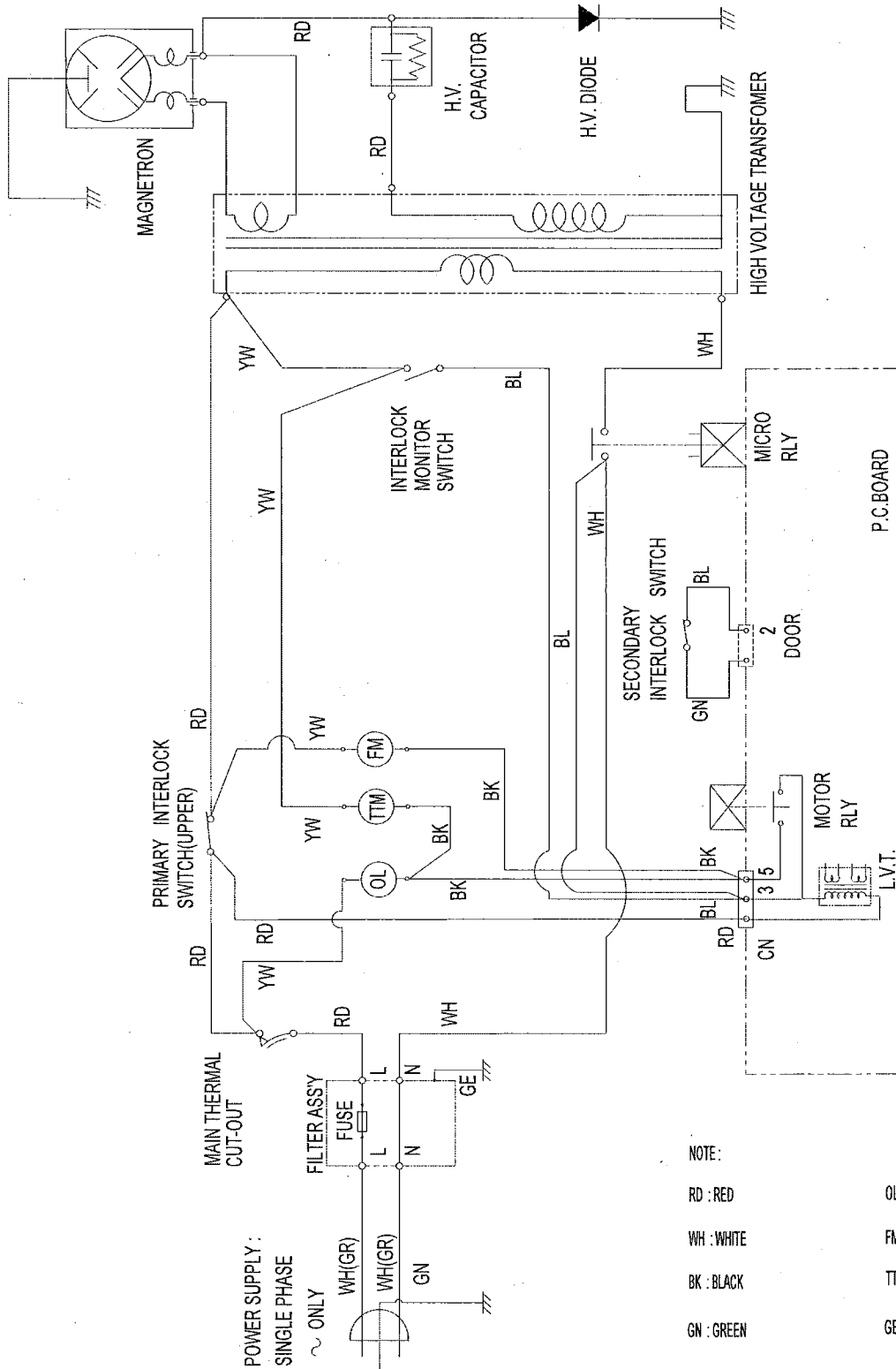



NOTE:

- RD : RED
- WH : WHITE
- BK : BLACK
- GN : GREEN
- BL : BLUE
- GR : GRAY
- OL : OVEN LAMP
- FM : FAN(BLOWER) MOTOR
- TTM : TURN TABLE MOTOR
- GE : GREEN/YELLOW
- [CONDITION]
- DOOR : CLOSED
- COOK : OFF

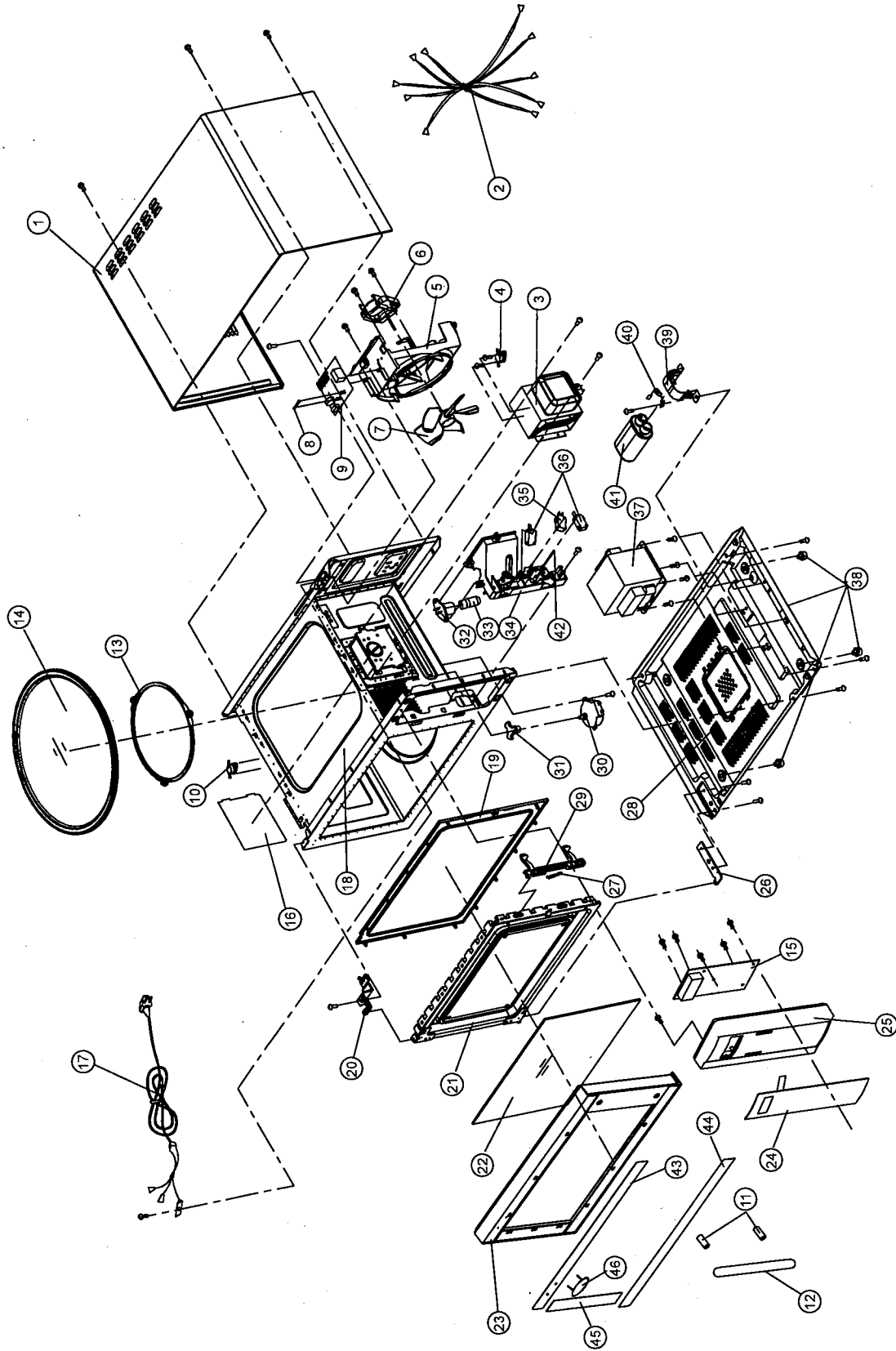
EXPLODED VIEW



PARTS LIST

REF NO.	PARTS CODE	DESCRIPTION	Q'TY	REMARK
1	MM251502600195	Cabinet	1	
2	MM251202800340	Wire assy.	1	
3	MM251200100729	Magnetron	1	
4	MM251201300649	Magnetron cabinet	1	
5	MM251300800011	Wind guide	1	
6	MM251200600037	Fan motor	1	
7	MM251300900015	Fan	1	
8	 MM251201200605	Fuse	1	
9	MM251400300134	Filter	1	
10	MM251201300649	Thermostat	1	
11	MM251509400008	Handle Base	2	
12	MM251509400007	Handle	1	
13	MM252200200013	TT-ring assembly	1	
14	MM252100500015	Turntable	1	
15	MM251400100485	PCB assy.	1	
16	MM252100100016	Mica plate	1	
17	 MM251201000175	Power cord	1	
18	MM251500100734	Cavity assembly	1	
19	MM251300600034	Gasket	1	
20	MM251502400009	Stopper-top assembly	1	
21	MM251500200054	Door-plate assembly	1	
22	MM252100400187	Glass	1	
23	MM251300102291	Door frame	1	
24	MM251400200850	Touch pad	1	
25	MM251300202211	Control panel	1	
26	MM251502500012	Stopper-under assembly	1	
27	MM252010000012	Hook spring	1	
28	MM251501400049	Base plate	1	
29	MM251300500019	Hook	1	
30	MM251200300676	Turntable motor	1	
31	MM252200100008	TT-ring	1	
32	MM251201400600	Lamp holder	1	
33	MM251201500603	Lamp	1	
34	MM251301300026	Switch bracket	1	
35	MM251201600604	Monitor switch	1	
36	MM251201600002	Interlock switch	2	
37	 MM251200200261	H.V. transformer	1	
38	MM251302000009	Foot	4	
39	MM251501500010	H.V. capacitor holder	1	
40	MM251200900599	H.V. diode	1	
41	MM251200700622	H.V. capacitor	1	
42	MM251301100014	Lever	1	
43	MM251508900480	Door S.S. flake-top	1	
44	MM251509000522	Door S.S. flake-down	1	
45	MM251509100521	Door S.S. flake-left	1	
46	MM251830300195	Brand	1	

SANYO

SANYO Electric Co., Ltd.
Osaka, Japan

Free Manuals Download Website

<http://myh66.com>

<http://usermanuals.us>

<http://www.somanuals.com>

<http://www.4manuals.cc>

<http://www.manual-lib.com>

<http://www.404manual.com>

<http://www.luxmanual.com>

<http://aubethermostatmanual.com>

Golf course search by state

<http://golfingnear.com>

Email search by domain

<http://emailbydomain.com>

Auto manuals search

<http://auto.somanuals.com>

TV manuals search

<http://tv.somanuals.com>