

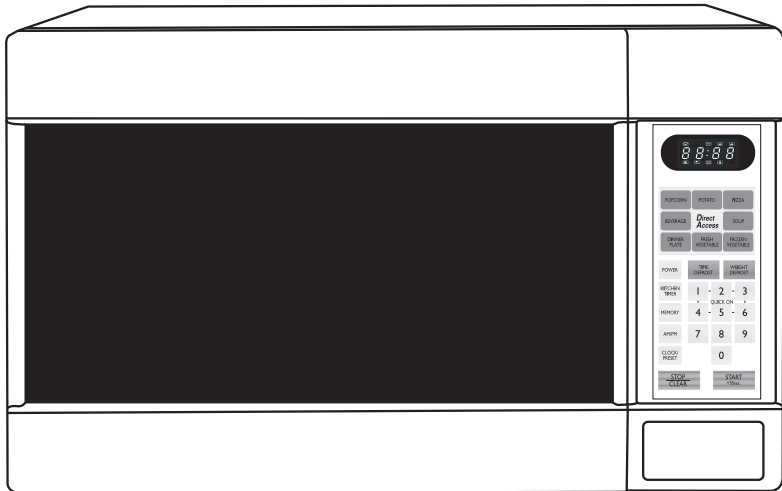

INSTRUCTION MANUAL

EM-S8586W/V

Microwave Oven



Read these instructions carefully before use.
If you follow these instructions,
your Microwave Oven will serve you long and well.

TABLE OF CONTENTS

PRECAUTIONS TO AVOID POSSIBLE EXPOSURE TO EXCESSIVE MICROWAVE ENERGY

Specifications	2
----------------	---

IMPORTANT SAFETY INSTRUCTIONS

Safety	3
Warning	4
To reduce the risk of injury to persons	5
Grounding installation	5
Danger	5
Warning	5
Caution	6
Utensils	6
Materials you can use in microwave oven	6
Materials to be avoided in microwave oven	7

SETTING UP YOUR OVEN

Names of Oven Parts and Accessories	7
Turntable installation	8
Countertop installation	8
Installation	8

OPERATION

Control panel and features	9
Operation	10

MAINTENANCE

Troubleshooting	17
-----------------	----

PRECAUTIONS TO AVOID POSSIBLE EXPOSURE TO EXCESSIVE MICROWAVE ENERGY

- (a) Do not attempt to operate this oven with the door open since this can result in harmful exposure to microwave energy. It is important not to break or tamper with the safety interlocks.
- (b) Do not place any object between the oven front face and the door or allow soil or cleaner residue to accumulate on sealing surfaces.
- (c) **Do not operate the oven if it is damaged. It is particularly important that the oven door closes properly and that there is no damage to the:**
 - (1) **DOOR (bent)**
 - (2) **HINGES AND LATCHES (broken or loosened)**
 - (3) **DOOR SEALS AND SEALING SURFACE**
- (d) **The oven should not be adjusted or repaired by anyone except properly qualified service personnel.**

ADDENDUM

If the apparatus is not maintained in a good state of cleanliness, its surface could be degraded and affect the lifespan of the apparatus and lead to a dangerous situation.

Specifications

Model:	EM-S8586W/V
Power Source:	220V-240V 50Hz
Power Consumption:	1500W
Output Microwave:	1100W 2450MHz
Outside Dimensions (WxHxD):	51.9 cm x 43.7 cm x 31.5 cm
Oven Capacity:	34L
Turntable Diameter:	31.5 cm
Net Weight:	16.0 kg

SAFETY

1. The oven must be on a leveled surface.
2. The turntable and turntable roller rest must be in the oven during cooking. Place the cookware gently on the turntable and handle it carefully to avoid possible breakage.
3. Incorrect use of browning dish may cause the turntable to break.
4. Use only the specified bag size when using Direct Access Popcorn.
5. The oven has several built-in safety switches to ensure that the power remains off when the door is open. Do not tamper with these switches.
6. Do not operate the microwave oven empty. Operating the oven with no food or food that is extremely low in moisture can cause fire, charring or sparking.
7. Do not cook bacon directly on the turntable. Excessive local heating of the turntable may cause the turntable to break.
8. Do not heat baby bottles or baby food in the microwave oven. Uneven heating may occur and could cause physical injury.
9. Do not heat narrow-necked containers, such as syrup bottles.
10. Do not attempt to deep-fry in your microwave oven.
11. Do not attempt home canning in this microwave oven, as it is impossible to be sure all contents of the jar have reached boiling temperature.
12. Do not use this microwave oven for commercial purpose. This microwave oven is made for household use only.
13. To prevent delayed eruptive boiling of hot liquids and beverages or scalding yourself, stir liquid before placing the container in the oven and again halfway through cooking time. Let stand in the oven for a short time and stir again before removing the container.
14. Use carefully when cooking food in the microwave oven to avoid burning due to excessive cooking.
15. When the appliance is operated in the combination mode, children should only use the oven under adult supervision due to the temperatures generated.
16. Failure to maintain the oven in a clean condition could lead to deterioration that could adversely affect the life of the appliance and possibly result in a hazardous situation.

IMPORTANT SAFETY INSTRUCTIONS

WARNING

To reduce the risk of fire, electric shock, injury to persons or exposure to excessive microwave oven energy when using your appliance, follow basic precautions, including the following:

1. Read all instructions before using the appliance.
2. Read and follow the specific: "**PRECAUTIONS TO AVOID POSSIBLE EXPOSURE TO EXCESSIVE MICROWAVE ENERGY**"
3. As with most cooking appliances, close supervision is necessary to reduce the risk of a fire in the oven cavity.

If materials inside the oven ignite:

1. Keep the oven door closed.
2. Turn the oven off, and unplug the appliance.
3. Disconnect the power cord, shut off power at the fuse or circuit breaker panel.
4. Do not overcook food. Carefully attend the appliance when paper, plastic, or other combustible materials are placed inside the oven to facilitate cooking.
5. Do not use the oven cavity for storage purposes. Do not store combustible items such as bread, cookies, paper products, etc. inside the oven.
6. Remove wire twist-ties and metal handles from paper or plastic containers/bags before placing them in the oven.
7. This oven must be grounded. Connect only to properly grounded outlet. See "**GROUNDING INSTRUCTIONS**".
8. Install or locate this oven only in accordance with the installation instructions provided.
9. Some products such as whole eggs, water with oil or fat, sealed to explode and therefore should not be heated in this oven.
10. As with any appliance, close supervision is necessary when used by children.

11. Use this appliance only for its intended uses as described in this manual. Do not use corrosive chemicals or vapors in this appliance. This oven is specifically designed to heat or cook food. It is not designed for industrial or laboratory use.
12. Do not operate this oven if it has a damaged cord or plug, if it is not working properly or if it has been damaged or dropped.
13. This appliance should be serviced only by qualified service technicians. Contact the nearest authorized service facility for examination, repair or adjustment.
14. Do not cover or block any vents on the oven.
15. Do not store or use this appliance outdoors.
16. Do not use this oven near water, for example, near a kitchen sink, in a wet basement, near a swimming pool, or similar locations.
17. Do not immerse cord or plug in water
18. Keep cord away from heated surfaces.
19. Do not let cord hang over edge of table or counter
20. When cleaning door and oven surfaces use only mild, nonabrasive soaps or detergents applied with a sponge or soft cloth.
21. This appliance is not intended for use by young children or infirm persons unless they have been adequately supervised by a responsible person to ensure that they can use the appliance safely.

Young children should be supervised to ensure that they do not play with the appliance.

22. Liquids, such as water, coffee, or tea are able to be overheated beyond the boiling point without appearing to be boiling. Visible bubbling or boiling when the container is removed from the microwave oven is not always present. This could result in very hot liquids suddenly boiling over when the container is disturbed or a spoon or other utensil is inserted into the liquid.

- i) Do not overheat the liquid.
- ii) Stir the liquid both before and halfway through heating it.
- iii) Do not use straight-sided containers with narrow necks.
- iv) After heating, allow the container to stand in the microwave oven for a short time before removing the container.
- v) Use extreme care when inserting a spoon or other utensil into the container.

SAVE THESE INSTRUCTIONS

To Reduce the Risk of Injury to Persons

Grounding Installation

DANGER

Electric Shock Hazard

Touching some of the internal components can cause serious personal injury or death. Do not disassemble this appliance.

WARNING

Electric Shock Hazard

Improper use of the grounding can result in electric shock. Do not plug into an outlet until appliance is properly installed and grounded.

Insulated plug

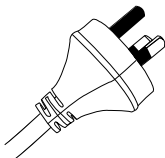

This appliance must be grounded. In the event of an electrical short circuit, grounding reduces the risk of electric shock by providing an escape wire for the electric current. This appliance is equipped with a cord having grounding

wire with a grounding plug. The plug must be plugged into an outlet that is properly installed and grounded.

Consult a qualified electrician or serviceman if the grounding instructions are not completely understood or if doubt exists as to whether the appliance is properly grounded. If it is necessary to use an extension cord, use only a 3-wire extension cord that has a 3-pronged grounding plug, and a 3-slot receptacle that will accept the plug on the appliance.

1. A short power-supply cord is provided to reduce the risks resulting from becoming entangled in or tripping over a longer cord.
2. If a long cord sets or extension cord is used:
 - 1) The marked electrical rating of the cord set or extension cord should be at least as great as the electrical rating of the appliance.
 - 2) The extension cord must be a grounding-type 3-wire cord.
3. The longer cord should be arranged so that it will not drape over the countertop or tabletop where it can be pulled on by children or tripped over unintentionally.

CAUTION

Personal Injury Hazard

Tightly-closed utensils could explode. Closed containers should be opened and plastic pouches should be pierced before cooking.

UTENSILS

See the instructions on "Materials you can use in microwave oven or to be avoided in microwave oven." There may be certain non-metallic utensils that are not safe to use for microwaving. If in doubt, you can test the utensil in question following the procedure below.

Utensil Test:

1. Fill a microwave-safe container with 1 cup of cold water (250ml) along with the utensil in question.
2. Cook on maximum power for 1 minute.
3. Carefully feel the utensil. If the empty utensil is warm, do not use it for microwave cooking.
4. Do not exceed 1 minute cooking time.

Materials you can use in microwave oven

Utensils Remarks

Aluminum foil	Shielding only. Small smooth pieces can be used to cover thin parts of meat or poultry to prevent overcooking. Arcing can occur if foil is too close to oven walls. The foil should be at least 1 inch (2.5cm) away from oven walls.
Browning dish	Follow manufacturer's instructions. The bottom of browning dish must be at least 3/16 inch (5mm) above the turntable. Incorrect usage may cause the turntable to break.
Dinnerware	Microwave-safe only. Follow manufacturer's instructions. Do not use cracked or chipped dishes.
Glass jars	Always remove lid. Use only to heat food until just warm. Most glass jars are not heat resistant and may break.
Glassware	Heat-resistant oven glassware only. Make sure there is no metallic trim. Do not use cracked or chipped dishes.
Oven cooking bags	Follow manufacturer's instructions. Do not close with metal tie. Make slits to allow steam to escape.
Paper plates and cups	Use for short-term cooking/warming only. Do not leave oven unattended while cooking.
Paper towels	Use to cover food for reheating and absorbing fat. Use with supervision for a short-term cooking only.
Parchment paper	Use as a cover to prevent splattering or a wrap for steaming.
Plastic	Microwave-safe only. Follow the manufacturer's instructions. Should be labeled "Microwave Safe". Some plastic containers soften, as the food inside gets hot. "Boiling bags" and tightly closed plastic bags should be slit, pierced or vented as directed by package.
Plastic wrap	Microwave-safe only. Use to cover food during cooking to retain moisture. Do not allow plastic wrap to touch food.
Thermometers	Microwave-safe only (meat and candy thermometers).
Wax paper	Use as a cover to prevent splattering and retain moisture.

Materials to be avoided in microwave oven

Utensils Remarks

Aluminum tray	May cause arcing. Transfer food into microwave-safe dish.
Food carton with metal handle	May cause arcing. Transfer food into microwave-safe dish.
Metal or metal-trimmed utensils	Metal shields the food from microwave energy. Metal trim may cause arcing.
Metal twist ties	May cause arcing and could cause a fire in the oven.
Paper bags	May cause a fire in the oven.
Plastic foam	Plastic foam may melt or contaminate the liquid inside when exposed to high temperature.
Wood	Wood will dry out when used in the microwave oven and may split or crack.

SETTING UP YOUR OVEN

Names of Oven Parts and Accessories

Remove the oven and all materials from the carton and oven cavity.

Your oven comes with the following accessories:

Glass tray	1
Turntable ring assembly	1
Instruction Manual	1

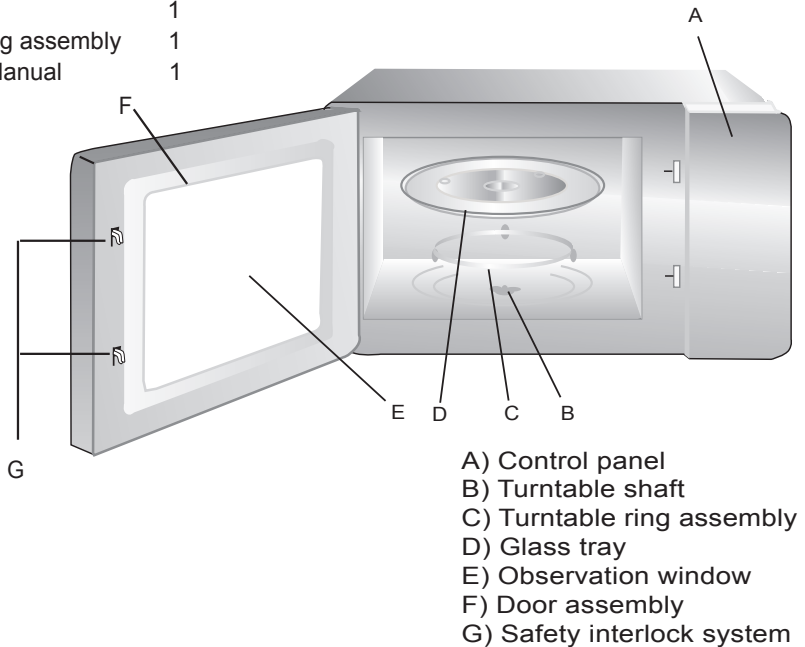

Turntable Installation

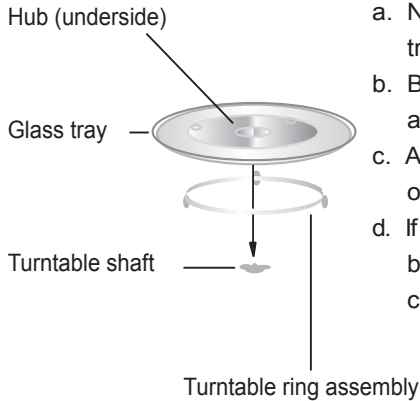

- Never place the glass tray upside down. The glass tray should never be restricted.
- Both glass tray and turntable ring assembly must always be used during cooking.
- All food and containers of food are always placed on the glass tray for cooking.
- If glass tray or turntable ring assembly cracks or breaks, contact your nearest authorized service center.

Countertop Installation

Remove all packing material and accessories. Examine the oven for any damage such as dents or broken door. Do not install if oven is damaged.

Cabinet: Remove any protective film found on the microwave oven cabinet surface. Do not remove the light brown Mica cover that is attached to the oven cavity to protect the magnetron.

Installation

1. Select a level surface that provide enough open space for the intake and/or outlet vents.

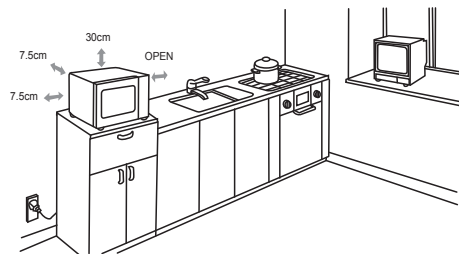

A minimum clearance of **7.5cm** is required between the oven and any adjacent walls. One side must be open.

- (1) Leave a minimum clearance of 30cm above the oven.
- (2) Do not remove the legs from the bottom of the oven.

- (3) Blocking the intake and/or outlet openings can damage the oven.
 - (4) Place the oven as far away from radios and TV as possible. Operation of microwave oven may cause interference to your radio or TV reception.
2. Plug your oven into a standard household outlet. Be sure the voltage and the frequency is the same as the voltage and the frequency on the rating label.

WARNING: Do not install oven over a range cooktop or other heat-producing appliance. If installed near or over a heat source, the oven could be damaged and the warranty would be void.

OPERATION

Control Panel and Features

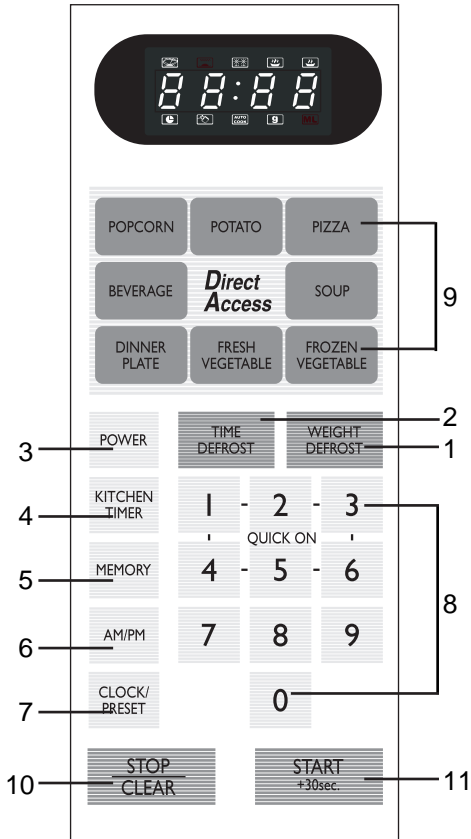

- (1) Weight Defrost
- (2) Time Defrost
- (3) Power
- (4) Kitchen Timer
- (5) Memory
- (6) AM/PM
- (7) Clock/Preset
- (8) Number keys
- (9) Auto Menus
- (10) Stop/Clear: clears all previous settings pressed before cooking starts. During cooking: press once to stop oven; twice to stop and clear all entries.
- (11) Start/ +30SEC.

Display Window

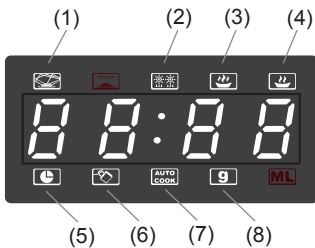

- (1). Microwave
- (2). Defrost
- (3). High power
- (4). Low power
- (5). Time
- (6). Lock function for children
- (7). Auto cook
- (8). Gramme

OPERATION

1. Power Level

Ten power levels are available.

Level	10	9	8	7	6	5	4	3	2	1
Power	100%	90%	80%	70%	60%	50%	40%	30%	20%	10%
Display	PL10	PL9	PL8	PL7	PL6	PL5	PL4	PL3	PL2	PL1

Remarks: when a power between level 10-8 is chosen, the high level indicator is lit and it will flash when in operation.

When a power between level 7-1 is chosen, the low level indicator is lit and it will flash when in operation.

2. Clock Setting

When the microwave oven is plugged into a outlet, the oven will display " 0:00 "

- (1) Press " CLOCK/PRESET ", LED will display 00:00, clock indicator will be lit. The hour figures will flash; ":" and "0" will be lit.
- (2) Press the number keys and enter the correct time. For example, time is 10:12 now, please press " 1,0,1,2" in turn.
- (3) Press " AM/PM " to choose AM or PM. AM or PM will be selected in turn by pressing the button of " AM/PM " continuously.
- (4) Press " CLOCK/PRESET" to finish clock setting, and the clock indicator will go out.
- (5) If the numbers input are not within the range of 1:00--12:59, the setting will be invalid until valid numbers are input.



Note: In the process of clock setting, if the " STOP/CLEAR " button is pressed or if there is no operation within 1 minute, the oven will go back to the former state automatically.



3. Kitchen Timer

- (1) Press " KITCHEN TIMER ", LED will display 00:00, clock indicator will be lit. The first "0" will flash; ":" and the other "0" will be lit.
- (2) Press the number keys and enter the required time.(the maximum time is 99 minutes and 99 seconds)
- (3) Press " START/+30SEC. " to confirm setting, clock indicator will be lit.
- (4) When the kitchen time arrives, clock indicator will go out. The buzzer will ring 5 times.

Note: The kitchen time is differ from 12-hour system,Kitchen Timer is a timer.

4. Microwave cook

- (1) Keep pressing " POWER " to choose microwave power. " and " " or " " will be lit.
- (2) Press number keys to input the cooking time, the maximum cooking time is 99 minutes and 99 seconds.

(3) Press " START/+30SEC. " to start cooking, and the remaining cooking time will be displayed. ":", "  ", "  " or "  " indicators will flash.

Note: In the process of cooking, if the " STOP/CLEAR " button is pressed or if there is no operation within 1 minute, the oven will go back to the former state automatically.



5. Fast Starting

(1) In waiting state, instant cooking at 100% power level can be started by selecting a cooking time from 1 to 6 minutes by pressing number pads 1 to 6. Press " START/+30SEC. " to increase the cooking time; the maximum cooking time is 99 minutes and 59 seconds.

(2) In waiting state, instant cooking at 100% power level with 30 seconds' cooking time can be started by pressing " START/+30SEC.". Each press on the same button will increase cooking time by 30 seconds. The maximum cooking time is 99 minutes and 59 seconds.



Note: Each pressing on "START/+30SEC." can increase the cooking by 30 seconds for the microwave and Auto menu cooking. However, the operation will not work under "Auto Defrost" (except " defrost by time") operation.

6. Defrosting By W.T. Function



(1) Press " WEIGHT DEFROST ", LED will display "dEF1"; at the same time "  ", "  " indicators will be lit.

(2) Press numerical pads to input weight to be defrosted. "g" indicator will be lighted. Input the weight ranged between 100~2000g.

(3) If the weight input is not within 100~2000g, the input will be invalid. No "beep" will be sound and the microwave will not work until valid numbers are input .

(4) Press " START/+30SEC. " to start defrosting and the remaining cooking time will be displayed. ":", "  " and "  " indicators will flash and the "g" indicator will go out.



7. Time Defrost Function

(1) Press " TIME DEFROST ", LED will display "dEF2". At the same time, "  ", "  " indicators will be lit.

(2) Press number pads to input defrosting time. The effective time range is 00:01~99:99



(3) If the time input is not within 00:01~99:99, no "beep" will be sound and the microwave will not work until valid numbers are input.







(4) The default microwave power is power level 3. If you want to change the power level, press " POWER " once, and the LED will display "PL 3", then press the number pad of the power level you wanted.

(5) Press " START/+30SEC. " to start defrosting. The cooking time remaining will be displayed. ":", "  " and "  " indicators will flash.

8. POPCORN

a) Default mode

1) Press " POPCORN " repeatedly to select popcorn mode, "  ", "  " and "g" are lit. " 50 " , "100" will appear in the LED in order.





- 2) Press " START/+30SEC." to start cooking, the buzzer will ring once, "g" will go out, "  ", "  " will flash.
- 3) When the cooking is over the buzzer will ring 5 times, LED will display "0:00".
If the clock be set (12-hour system), LED will display the current time.
- b) Time Adjustable mode (the max. time that can be set is 9 minutes and 59 seconds.)
 - 1) Press "POPCORN" to select popcorn mode, "  ", "  " and "g" are lit.
" 50 "or" 100 " appear in the LED.
 - 2) Press " MEMORY " , LED will display the cooking time of the selected weight, the minute figure is flashing.
 - 3) Press the number keys and enter the time.
 - 4) Press " MEMORY " to save the setting. If press " START/+30SEC. " directly , the oven will start cooking according to the modified time and save. "  " and "  " will flash.

Users can change the cooking time

e.g.: User set " POPCORN " time for 3 minutes and 15 seconds



- 1) Press "POPCORN" button once or twice when the oven is on call (the screen will display "50" for once press and "100" for twice), then press "MEMORY" button, LED screen will display the default cooking time of current food deal (which is not 0:00), for example 1'30". on the screen the first number 1 flash, press number button to input 3; the second number 3 flash, press number button to input 1; the third number 0 flash, press number button to input 5. and then the first number 3 flash again (It is similar to clock setting).
- 2) Press " MEMORY " again to save current setting. If press " START/+30SEC." to begin cooking directly, the program will save the latest setting of cooking time automatically.
- 3) To change the set cooking time, repeat step 1), the screen will firstly display the saved time (3:15 for example), press number button to reset cooking time, and the follow step 2).
- 4) When completed, whenever press " POPCORN " button, LED displays food weight 50 or 100g, only cooking time follows the saved time setting.
- 5) To go back to initialization, press " POPCORN " button for three seconds, the buzzer will sound, then go back to initial setting.

9.POTATO

- a) Press " POTATO " repeatedly until the number you needed appears in the LED, "  ", "  " will light.
"1"SET : 1 potato (approximate 200 grams)
"2"SETS: 2 potatoes (approximate 400 grams)
"3"SETS: 3 potatoes (approximate 600 grams)
For example, press " POTATO" once : " 1" appears in the display.
- b) Press "START/+30SEC. " to cook, "  ", "  " are flashing.

Times(Press "Potato")	Weight	Display
Once	200 g	1
Twice	400 g	2
Thrice	600 g	3

10. PIZZA

- a) Press " PIZZA " repeatedly until the number you wish appears in the LED, "", " " will light.

You can reheat 1~3 slices of Pizza each time .

Times(Press "Pizza")	Weight	Display
Once	80 g	1
Twice	160 g	2
Thrice	240 g	3

For example, press" PIZZA " twice, "2"appears in the LED.

- b) Press " START/+30SEC." to cook, "", " " are flashing.

11.BEVERAGE

- a) Press " BEVERAGE " repeatedly until the number you wish appears in the LED.

"  " and "  " will light.

You can reheat 1~3 cups of beverage each time (approximate 250 g).

For example, press " BEVERAGE" twice, "2" appears in the LED.

- b) Press " START/+30SEC. " to cook,

"  " and "  " are flashing.

Times(Press "BEVERAGE")	Weight	Display
Once	250 g	1
Twice	500 g	2
Thrice	750 g	3

12.SOUP

- a) Press " SOUP " repeatedly until the number you wish appears in the LED.



"  ", "  ", "g" will light.

For example, press " SOUP " twice, "750" appears in the LED.

- b) Press " START/+30SEC. " to cook, "", " " are flashing. "g" will go off.

Times(Press "SOUP ")	Weight	Display
Once	500 g	500
Twice	750 g	750
Thrice	1000 g	1000

13. DINNER PLATE



a) Press " DINNER PLATE " repeatedly until the number you need appears in the LED, "  ", "  " and "g" will light.

For example, press " DINNER PLATE " twice, "350" appears in the LED.



b) Press " START/+30SEC. " to cook, "  ", "  " are flashing. "g" will go off.

Times(Press "DINNER PLATE")	Weight	Display
Once	250 g	250
Twice	350 g	350
Thrice	500 g	500

14. FRESH VEGETABLE



a) Press " FRESH VEGETABLE " repeatedly until the number you needed appears in the display, "  ", "  " and "g" light.

For example, press " FRESH VEGETABLE " twice, "350" appears in LED.



b) Press " START/+30SEC. " to cook, "  ", "  " are flashing. "g" will go off.

Times(Press "FRESH VEGETABLE")	Weight	Display
Once	150 g	150
Twice	350 g	350
Thrice	500 g	500

15. FROZEN VEGETABLE

a) Press " FROZEN VEGETABLE " repeatedly until the number you wish appears in the display, "  ", "  " and "g" light.

For example, press " FROZEN VEGETABLE " twice, "350" appears in the LED.

b) Press "START/+30SEC. " to cook, "g" disappears, "  ", "  " are flashing.

Times(Press "FROZEN VEGETABLE")	Weight	Display
Once	150 g	150
Twice	350 g	350
Thrice	500 g	500

16. PRE-SET FUNCTION

(1) Set the clock first. (Consult the instruction of clock setting.)

(2) Set a certain cooking procedure (one or two blocks), the setting method and display are same as relevant cooking procedure. (Defrosting is beyond pre-set cooking).

(3) Press " CLOCK/PRESET " to display current time and hour figure is flashing, the icon " : " keep lighting on.

- (4) Press number keys to input the cooking time. For example: to set the time is 12:12, you can press the number keys "1", "2", "1", "2" in order.
- (5) Press " AM/PM " to choose AM or PM. AM or PM will be selected in turn by pressing the button of " AM/PM " continuously.
- (6) Press "START/ +30 SEC." to confirm the preset procedure. When it is confirmed, the unit will go back the clock states.
- (7) When time arrives, the buzzer will sound twice and the cooking starts.

17. Multi-section cooking

At most 2 sections can be set for cooking. In multi-section cooking, if one section is weight defrosting, then weight defrosting shall be placed in the first section. When the first stage finish, the buzzer will sound once and the next stage will begin cooking.

Example: if you want to cook with 80% microwave power for 5 minutes + 60% microwave power for 10 minutes. The cooking steps are as following:

- (1) Press "POWER" 3 times to choose 80% microwave, now "PL8" is displayed.
- (2) Press number keys "5", "0", "0" to set the cooking time.
- (3) Press "POWER" 5 times to choose 60% microwave power, "PL6" is displayed.
- (4) Press number keys "1", "0", "0", "0" to set the cooking time.
- (5) Press "START/+30SEC." to start cooking.

18. MEMORY FUNCTION

- (1) Press "MEMORY" key several times to set "memory 1" to "memory 5" program, and the oven will display "1", to "5".
- (2) Set one or two stages program you want.
Example: a) Press "POWER" once to choose 100% microwave power;
b) Press number keys "1", "0", "0", "0" in order to adjust the cooking time;
- (3) Press "MEMORY" key to save the memory program setted, or press "START/+30SEC." to start cooking and save the program automatically.
- (4) Next time when you want to cook with the memory program which has been set, you just only need to press "MEMORY" key to choose the program wanted and then press "START/+30SEC." to start cooking.

19. INQUIRING FUNCTION

- (1) In clock state, press " AM/PM " to display "A" or "P" for 3 seconds.
In cooking state, press " CLOCK/PRESET ", the LED will display the clock for three seconds and the "A" or "P" for another 3 seconds.
- (2) In pre-set state, LED will display the clock and the seconds will be flashing at the same time. Press " AM/PM" and "A" or "P" will be displayed for 3 seconds. Then press " CLOCK/ PRESET" to inquire the pre-set time. The pre-set time will flash for 3 seconds, then "A" or "P" will be displayed for another 3 seconds. After that, the oven will turn back to the clock state.

- (3) In the microwave cooking state, press " POWER " to inquire microwave power level, and the current microwave power will be displayed. After three seconds, the oven will turn back to the previous state. In the 2 stage cooking state, the inquiring way can be done by the same way as above.

20. LOCK FUNCTION FOR CHILDREN

Lock: In waiting state, press " STOP/CLEAR " for 3 seconds, there will be a long "beep" denoting the entering the children-lock state; meanwhile, LED will display " [_ _ _] "

Lock quitting: In locked state , press " STOP/CLEAR " for 3 seconds, there will be a long "beep" denoting that lock is released.

21. COOKING END REMINDING FUNCTION

When the cooking is over, the buzzer will sound 5 "beep" to remind user the cooking is finished.

22. OTHER SPECIFICATIONS

- (1) In waiting state , if the LED displays current time, the icon " : " would flash, otherwise, it shows " 0:00 ".
- (2) In setting function state, LED displays corresponding setting.
- (3) In working or pause state, LED displays remained cooking time.

Maintenance

Troubleshooting

Check your problem by using the chart below and try the solutions for each problem. If the microwave oven still does not work properly, contact the nearest authorized service center.

TROUBLE	POSSIBLE CAUSE	POSSIBLE REMEDY
Oven will not start	<ul style="list-style-type: none">a. Electrical cord for oven is not plugged in.b. Door is open.c. Wrong operation is set.	<ul style="list-style-type: none">a. Plug into the outlet.b. Close the door and try again.c. Check instructions.
Arcing or sparking	<ul style="list-style-type: none">a. Materials to be avoided in microwave oven were used.b. The oven is operated when empty.c. Spilled food remains in the cavity.	<ul style="list-style-type: none">a. Use microwave-safe cookware only.b. Do not operate with oven empty.c. Clean cavity with wet towel.
Unevenly cooked foods	<ul style="list-style-type: none">a. Materials to be avoided in microwave oven were used.b. Food is not defrosted completely.c. Cooking time, power level is not suitable.d. Food is not turned or stirred.	<ul style="list-style-type: none">a. Use microwave-safe cookware only.b. Completely defrost food.c. Use correct cooking time, power level.d. Turn or stir food.
Overcooked foods	<p>Cooking time, power level is not suitable.</p>	<p>Use correct cooking time, power level.</p>
Undercooked foods	<ul style="list-style-type: none">a. Materials to be avoided in microwave oven were used.b. Food is not defrosted completely.c. Oven ventilation ports are restricted.d. Cooking time, power level is not suitable.	<ul style="list-style-type: none">a. Use microwave-safe cookware only.b. Completely defrost food.c. Check to see that oven ventilation ports are not restricted.d. Use correct cooking time, power level.
Improper defrosting	<ul style="list-style-type: none">a. Materials to be avoided in microwave oven were used.b. Cooking time, power level is not suitable.c. Food is not turned or stirred.	<ul style="list-style-type: none">a. Use microwave-safe cookware only.b. Use correct cooking time, power level.c. Turn or stir food.



SANYO Electric Co., Ltd.

Free Manuals Download Website

<http://myh66.com>

<http://usermanuals.us>

<http://www.somanuals.com>

<http://www.4manuals.cc>

<http://www.manual-lib.com>

<http://www.404manual.com>

<http://www.luxmanual.com>

<http://aubethermostatmanual.com>

Golf course search by state

<http://golfingnear.com>

Email search by domain

<http://emailbydomain.com>

Auto manuals search

<http://auto.somanuals.com>

TV manuals search

<http://tv.somanuals.com>