

Uninterruptible Power Supply

SANUPS

E11A102A

Instruction Manual

SANYO DENKI

M0007084E

Introduction

Thank you for choosing the SANUPS (E11A102A).

SAVE THESE INSTRUCTIONS

This manual contains important instructions for E11A102U001 that should be followed during installation and maintenance of the UPS and batteries. To use the UPS correctly and safely, read this manual before using the UPS. After reading, please keep it handy for convenient reference.

This UPS is intended for installation in a temperature-controlled indoor environment free of conductive contaminants.

- Operating temperature: 0 to 40° C (32 to 104° F)

UPS is an abbreviation for Uninterruptible Power Supply.

Table of contents

1. Safety Precautions	1
2. For Proper Operation	6
2.1 Input Power Requirements	6
2.2 Installation Precautions	6
2.3 Usage Precautions	6
2.4 Dealing with Errors	7
3. Checking the Contents of the Package	7
4. Overview	8
5. External Dimensions and Part Names	9
5.1 Front and Back Panels	9
5.2 Control Panel and Indicators	10
5.3 External Interfaces	11
6. Installation	12
6.1 Environment	12
6.2 Transporting	12
6.3 Installation Space	12
6.4 Preparation Before Installation	13
6.5 Attaching the Stand	14
6.6 Mounting a Rack Mount Type UPS	15
6.7 Inserting the Bushings	15
7. Wiring	16
7.1 UPS Wiring	16
7.2 External Interface Connections	17
8. Preparations Before Operation	18
9. Operating Procedures	19
9.1 UPS Startup (Normal Operation)	19
9.2 UPS Startup (Battery Power)	20
9.3 Outage Simulation Test	21
9.4 UPS Shutdown (Daily)	22
9.5 UPS Shutdown (If Not to Be Used for More Than a Week)	22
10. User Settings	23
10.1 Setup Menu Item List	23
10.2 Setup Menu Operations	24
11. Maintenance and Inspection	25
11.1 Daily Inspection	25
11.2 Periodic Inspection	25
11.3 Parts Replacement	25
11.4 Battery Maintenance	26
11.5 Battery Test	27
11.6 Battery Exchange	28
11.7 Bypass Fuse Exchange	30
12. Troubleshooting	31
13. Alarm Sounds	33
14. Maintenance Bypass Power Supply (Option)	34
15. Functional Description	35
15.1 Basic Operation	35
15.2 Protective Functions	37
15.3 Protective Function Table	38
15.4 Specifications	39
16. Warranty	40
Appendix Usage notes for SANUPS SOFTWARE STANDALONE	41

1. Safety Precautions

PRECAUTIONS (IMPORTANT SAFETY INSTRUCTIONS)

Before installing, operating, performing maintenance or inspecting the UPS, be sure to read this manual and accompanying documents carefully to obtain a clear understanding of the information related to its operation, safety and important precautions.

This manual described two warning levels, DANGER and CAUTION, as described below.



: Denotes immediate hazards which WILL probably cause severe bodily injury or death, as a result incorrect operation.



: Denotes hazards which COULD cause bodily injury and product or property damage, as a result incorrect operation.

Additionally, even those hazards denoted by  could lead to a serious accident, so the instructions should be strictly followed.

The following labels indicate particularly important instructions which must be carefully followed. The graphic symbols indicate prohibited and mandatory actions



: Indicates actions that must not be allowed to occur (prohibited actions).



: Indicates actions that must be taken (mandatory actions).

1. Installation Precautions



CAUTION

- The UPS should be installed only by technically qualified personnel. Improper installation can result in electric shock, bodily injury, and/or fire.
- Never operate or store the UPS in the following environmental conditions. Doing so may cause the UPS to malfunction, sustain damage or deteriorate, which could result in a fire.
 - a. In ambient environmental conditions other than those specified in the product brochure and instruction manual (temperature 0 to 40°C (32 to 104° F), relative humidity 20 to 90%), such as in extremely high or low temperature and high humidity.
 - b. Where the UPS is exposed to direct sunlight.
 - c. Where the UPS is directly exposed to the heat from a heat source, such as a stove.
 - d. Where the UPS may be subject to vibration or physical shock.
 - e. Near a device that may emit sparks.
 - f. In the presence of dust, salt or corrosive or flammable gas.
 - g. Outdoors
- If you mount the UPS in a rack, mount it in a rack that can be well ventilated, and be careful not to block the air intake and exhaust vents of the rack and UPS. Do not allow the air intake or exhaust vents to be obstructed. Keep the front and back of the UPS at least 20 cm away from the wall. If the air intake or exhaust vent is blocked, the internal temperature of the UPS rises, which could cause battery deterioration resulting in a fire. For maintenance, the UPS requires at least 1 m (39.4in) space at the front.
- The space around the UPS and the rack must be ventilated. Unless the specified ventilation airflow (5 m³/h) is maintained, gas produced by battery charging could result in rupture or explosion of the case.
- Install the UPS on a stable surface capable of bearing the weight (16kg, 35.27 lbs) of the UPS in the correct manner specified in this manual. If the UPS is installed incorrectly, impact or vibration could cause it to fall or move inadvertently, resulting in bodily injury. Be careful to avoid back strain.

2. Wiring Precautions



CAUTION

- Wiring should be performed only by technically qualified personnel. Incorrect wiring can result in electric shock and/or fire.
- Protection in primary circuits against over currents, short circuits and earth faults is not provided inside this UPS. Protection in primary circuit against over currents short circuits and earth faults shall be provided as part of the building installation.
- Connect the grounding cable securely in the manner specified. Failure to connect the grounding cable may result in electric shock.
- The grounding cables of all load devices* connected to the output of the UPS must be securely connected to the grounding terminal. Failure to connect the grounding cables correctly may result in electric shock.
- The socket-outlet shall be installed near the equipment and shall be easily accessible.



* Load devices are devices such as computers that are connected to the UPS.

3. Operating Precautions



DANGER

- Immediately shut the UPS off if it malfunctions, or if an unusual odor or noise is observed. Failure to do so may result in a fire.
- To avoid electric shock, do not open the cover of the UPS.



CAUTION

- Risk of electric shock, do not remove cover, No user serviceable part inside. Refer servicing to qualified personnel.
- The space around the UPS must be well ventilated. Otherwise, gas produced by battery charging could result in rupture or explosion of the case.
- Before starting the UPS, make sure that the load side is safe. Be sure to refer to the instruction manual while operating the UPS. The operating state of the UPS, as determined by the INV. ON/STAND BY switch and the MAIN switch, is indicated by the LEDs as shown the table below.
- The following table shows the UPS states resulting from operation of the MAIN SW and INV ON/STAND BY switches. Check the indicators before and after operating. Do not touch the MAIN SW and INV ON/STAND BY switches unless necessary. If power is supplied incorrectly, an electric shock or bodily injury could result.

UPS Status		Power Output Status	LEDs	
MAIN SW	INV ON/STAND BY	OUTPUT		
OFF	STAND BY	Stopped	INPUT (off-green),	OUTPUT (off-green)
ON	STAND BY	Stopped	INPUT (on-green),	OUTPUT (off-green)
OFF	ON	Power supplied from inverter	INPUT (blinking-green),	OUTPUT (on-green)
ON	ON	Power supplied from inverter	INPUT (on-green),	OUTPUT (on-green)

- Avoid inserting sharp objects or fingers into the fan. Doing so may result in bodily injury.
- Do not touch the UPS, including the cables, if you hear thunder nearby. There is danger of electric shock from a lightning strike.
- Do not detach the cover of the options, except when you use some options. There is danger of electric shock and equipment damage.



PROHIBITED

- Never use the UPS for the following types of loads:
 - a. Medical instruments used for life support.
 - b. Control units for trains or elevators, failure of which could cause bodily injury.
 - c. Computer systems upon which social or public infrastructure depends.
 - d. Devices which serve applications related to the above.

Contact your sales representative if you need to use the UPS in an application like the above. Special equipment, such as redundant devices or an emergency generator must be incorporated when operating, maintaining and controlling systems in which a UPS is used with loads affecting life-support or public infrastructure-dependent applications.
- Do not smoke or use an open flame near the UPS, as it could cause the UPS to explode or rupture, resulting in injury or fire.
- Do not place containers of liquid, such as a flower vase, on the UPS. If the container was to spill, the liquid could cause a short circuit, resulting in sparks or fire inside the UPS.
- Do not sit, step or lean on the UPS, as bodily injury could result if the UPS was to fall.
- Repairs and modifications to the UPS prohibited
 All repairs and modifications to the UPS are prohibited. The UPS contains high voltage and no user serviceable parts. Opening the cover, exchanging the battery, parts exchange, and repair can result in electric shock and damage to the UPS when performed by anyone other than qualified service personnel. All such repairs and modifications will void the warranty.

4. Radio Frequency Interference



CAUTION

- This equipment has been tested and found to comply with the limits for a Class A digital device, pursuant to part 15 of the FCC Rules. These limits are designed to provide reasonable protection against harmful interference when the equipment is operated in a commercial environment. This equipment generates, uses, and can radiate radio frequency energy and, if not installed and used in accordance with the instruction manual, may cause harmful interference to radio communications. Operation of this equipment in the residential area is likely to cause harmful interference in which case the user will be required to correct the interference at his own expense.

5. Maintenance and Inspection Precautions



CAUTION

- Maintenance and repair of the inside of the UPS should be performed only by technically qualified personnel. Electric shock, bodily injury and burns, fuming, or fire could otherwise result.
- Contact your nearest sales representative or authorized service center to have the UPS checked out or to replace defective parts. Opening the cover carelessly can result in an electric shock or burn.
- Replace the batteries periodically (once every 4.5 years when operated at 25°C (77° F)). Using batteries after their service life has expired may cause a fire.
- Never use organic chemicals such as gasoline, thinner, benzene or detergent to clean batteries. These can cause the casing to crack and leak, resulting in fire.
- Do not allow sharp metallic objects or fingers to touch the battery connectors of the UPS. Doing so may result in an electric shock.
- Do not touch any parts inside the UPS, even when AC input is removed. Voltage produced from the batteries can still cause an electric shock.

6. Relocation and Transportation Precautions



CAUTION

- Be careful to avoid falling or dropping the UPS during relocation or transportation, as bodily injury could result.
- Be careful to avoid back strain when handling the UPS.
- To avoid bodily injury caused by dropping the UPS, do not tilt it more than 10 degrees to either side when moving it. Take preventative measures to avoid dropping the UPS if it must be tilted more than 10 degrees when moving it.

7. Battery Handling Precautions



CAUTION

- Risk of explosion if battery is replaced by an incorrect type
- Dispose of used batteries according to the instructions.
- Battery servicing should be performed by technically qualified personnel. Keep unqualified personnel away from batteries.
- Replace batteries only with the same model and brand: HRL1234WF2FR manufactured by CSB BATTERY Co., LTD.
- Customers should not dispose of used batteries themselves. Contact your nearest sales representative, authorized service center or sales office to dispose of used batteries.
- Do not use batteries after their service life has expired. Doing so may result in fuming or fire. Additionally, the battery backup function may fail to operate with such batteries, so that power will not be supplied to the load when a power outage occurs.
- Batteries pose hazards for electrical shock and dangerous short-circuit current. The following precautions should be observed when working with batteries:
 - a. Remove watches, rings and other metal objects.
 - b. Use insulated tools.
 - c. Wear rubber gloves and boots.
 - d. Do not lay tools or metal parts on top of batteries.
 - e. Disconnect the charging source prior to connecting or disconnecting battery terminals.
 - f. Determine whether the batteries have been inadvertently grounded, and if so, remove the source of grounding. Contact with any part of a grounded battery can result in electric shock.
- Do not attempt to open or disassemble batteries. The electrolyte is harmful to the skin and eyes. The battery contains diluted sulfuric acid, which is extremely toxic. If a battery leaks, take appropriate measures to prevent any battery fluid contacting your skin or clothing. Diluted sulfuric acid may cause blindness if it gets into the eye, may burn skin upon contact. It is electrically conductive and corrosive. Observe the following procedures if electrolyte spills:
 - a. Wear full eye protection and protective clothing.
 - b. If sulfuric acid contacts the skin, wash it off immediately with water.
 - c. If sulfuric acid contacts the eyes, flush thoroughly and immediately with water, and seek medical attention.
 - d. Spilled sulfuric acid should be washed down with a suitable acid-neutralizing agent, such as a solution of approximately one pound (500 grams) bicarbonate of soda in one gallon (4 liters) of water. The bicarbonate of soda solution should be applied until evidence of reaction (foaming) has ceased. The resulting liquid should be flushed with water and the area dried.
- Lead acid batteries can present a risk of fire due to generation of hydrogen gas. The following procedures should always be followed:
 - a. DO NOT SMOKE when near batteries.
 - b. DO NOT allow flames or sparks near batteries.
 - c. Before working with batteries, discharge static electricity from the body by first touching a grounded metal surface before touching the batteries.
- Do not dispose of batteries in fire, as they could explode.
- If a fire occurs near a battery, do not use water to extinguish it. Use only a powder-distinguishing agent (ABC). Using water can cause the fire to spread.
- Strictly observe the following precautions when handling the batteries. Failure to do so may cause battery leakage, overheating or explosion.
 - a. Do not solder to any part of the battery directly.
 - b. Do not charge the battery with reversed positive (+) and negative (-) terminal polarity.
 - c. Do not mix different battery types, brands or versions.
 - d. Do not attempt to peel off or break the outer covering of a battery.
 - e. Do not subject batteries to strong physical shock, or throw them away.
 - f. Clean batteries with water-moistened cloth squeezed hard. Do not use organic compounds such as gasoline, thinner, benzene or detergent.
 - g. Electrical energy may remain in a battery even after its service life has expired.
Do not allow sparks near used batteries, and protect them from short-circuiting.

2. For Proper Operation

2.1 Input Power Requirements

- (1) Make certain that the AC input voltage and frequency correspond to the specified equipment rating (100V, 110V, 115V, 120V, within -20% and +15%, and 50 or 60 Hz $\pm 5\%$: Active Filter and Economy Mode*).

* The frequency variation range is set to $\pm 3\%$ when the UPS is shipped from the factory.

If the frequency variation range of input power supply is $\pm 5\%$, select $\pm 5\%$ as described in item ③ "Frequency sync range" of 10.1 "Setup Menu Item List". Because the frequency sync range is the same for both input and output, an input frequency error occurs when the frequency sync range exceeds the setting value, preventing the UPS from switching to active filter mode or economy mode operation.

- (2) The current capacity of the AC power supply must satisfy the requirements of the UPS (0.96 kVA or more). (Breaker capacity of 20 A or more is recommended.)

2.2 Installation Precautions

- (1) Carefully consider the leakage current when a leakage circuit breaker is installed on the input side. The maximum leakage current of the UPS is 3mA.
- (2) Keep the UPS at least 1 m (about 40 inches) away from CRT displays. Other devices which may be sensitive to magnetic flux should be kept away from the UPS, as it emits a slight amount of magnetic flux.
- (3) The UPS employs a fan for forced-air cooling. Provide at least 20 cm (about 8 inches) clearance at the front and back of the UPS to permit free airflow at the air intake and exhaust vents. Also, for maintenance purposes, a space of at least 1 m (about 40 inches) will be needed at the front of the UPS and a space of at least 50 cm (about 20 inches) will be needed at the back of the UPS.

When mounting the UPS in a rack, use a rack which allows ventilation and provide at least 20 cm (about 8 inches) clearance from the front and back of the rack to permit free airflow at the air intake and exhaust vents. Also, for maintenance purposes, a space of at least 1 m (about 40 inches) will be needed at the front of the rack, and a space of at least 50 cm (about 20 inches) will be needed at the back of the rack.

For details, see §6.3 "Installation Space".

- (4) When the AC input power is single-wire grounded, always connect the ground phase to the S terminal (phase) side on the UPS.
- (5) As far as possible, do not ground the output (load) side. If you must make a single-wire grounded connection, always connect the ground phase to the V terminal (phase) side on the UPS. (This is to prevent short-circuiting by the ground.)

2.3 Usage Precautions

- (1) Never short-circuit the output terminals, or connect a load which draws short-circuit current. Doing so causes protective functions to activate or fuses to open, preventing output.
- (2) Unsuitable load devices
Do not connect laser printers, plain paper fax machines, copy machines, or overhead projectors as load devices. Such devices typically include heating elements that draw high current. This may cause an overload that could prevent battery backup operation when an outage occurs, and could damage the UPS.
- (3) Power supply environment
If the UPS is used in an environment subject to long and frequent power outages (more than once a week), the batteries may not receive sufficient charge, which could result in foreshortened battery life and premature battery failure.
- (4) If the UPS is not operated for a long period, the batteries may require recharging. Operate the UPS with no load to recharge the batteries as indicated in the following table, according to the storage temperature. If the batteries in the UPS are left uncharged, their service life will be greatly foreshortened.

Storage Temperature	Charge Interval	No-Load Operation
25°C (77°F)	Once every 6 months	At least 20 hours
30°C (86°F)	Once every 4 months	At least 20 hours
40°C (104°F)	Once every 2 months	At least 20 hours

- (5) Insulation testing
Before testing indoor wiring insulation, shut down the UPS and disconnect the input and output cables. Conducting an insulation test with the UPS connected may damage electronic components such as the built-in arrester.
- (6) Rack support rails (not supplied) are required to mount the UPS on a rack. For details, contact your supplier or Sanyo Denki representative.

2.4 Dealing with Errors

Contact your supplier or Sanyo Denki representative if any of the following occur.

- (1) The red ALARM indicator lights (except when the UPS stops because of a prolonged power outage).
- (2) The green INV.ON/STAND BY indicator, green INPUT indicator, or green OUTPUT indicator does not light even when the UPS is operated properly.
- (3) Another condition occurs which you suspect is caused by a failure in the UPS.

3. Checking the Contents of the Package

After opening the package carton, check to be sure that it contains all of the following items. If any item is missing, contact your supplier or Sanyo Denki representative.

(1) UPS		1
(2) Accessories	Instruction Manual (this manual)	1
	Fuse 15 A	1
	Network cable	1
	Rack mounting bracket (Right)	1
	Rack mounting bracket (Left)	1
	Screws for Rack mounting brackets	4
	Bushings	6
	Stands	2
	Screws for Stands	4
	Power Management Software disc (CD-ROM) (SANUPS SOFTWARE STANDALONE) including Install Guide and User guide	1

*** Note about sale or transfer of ownership**

If you sell the UPS or transfer ownership to a third party, all accessories and other items supplied with the UPS must be sold or transferred together with the UPS.

4. Overview

The SANUPS E11A is a stationary-type uninterruptible power supply designed to provide high-quality, stable AC power to critical equipment that requires continuous, uninterrupted power.

The UPS is comprised of rectifier, charger, inverter, battery, and utility power transfer (bypass) circuits. In the event of failure of the AC utility power source, AC output to the load is sustained by the inverter converting DC power from the batteries. When the utility power recovers, inverter operation continues while the batteries are recharged. The UPS is therefore able to supply completely uninterrupted AC power to connected loads without even momentary power loss.

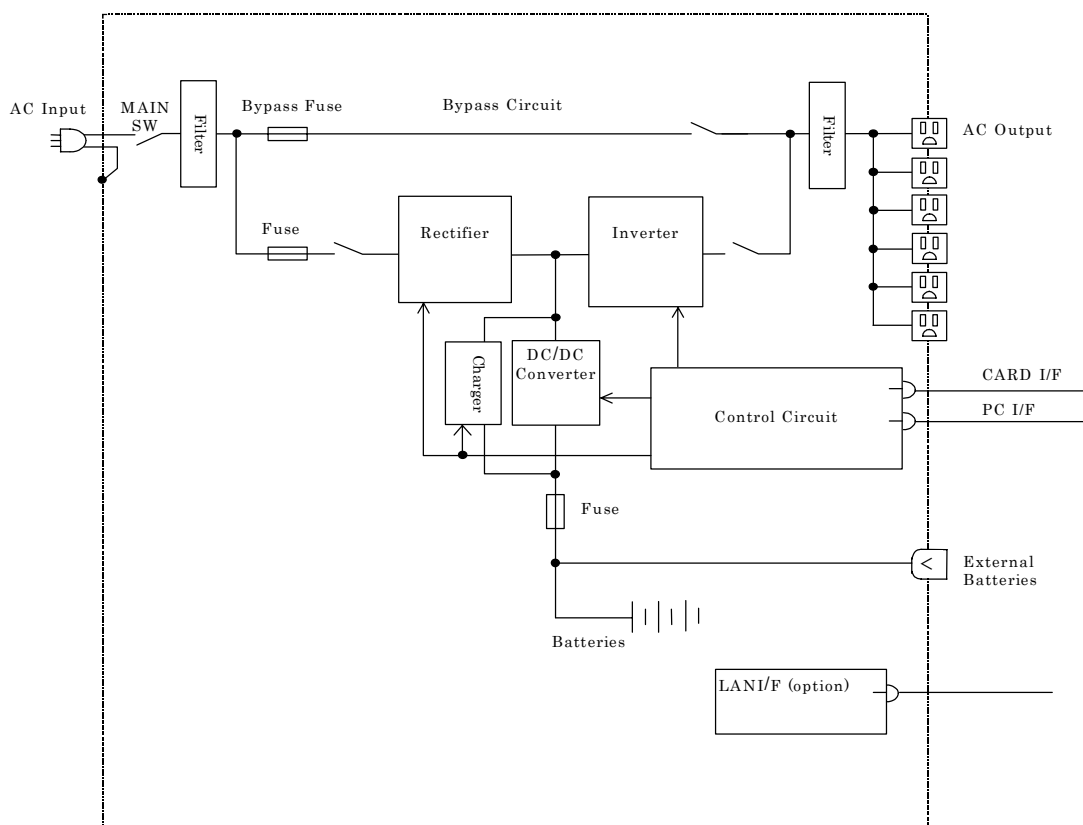

UPS Block Diagram

5. External Dimensions and Part Names

5.1 Front and Back Panels

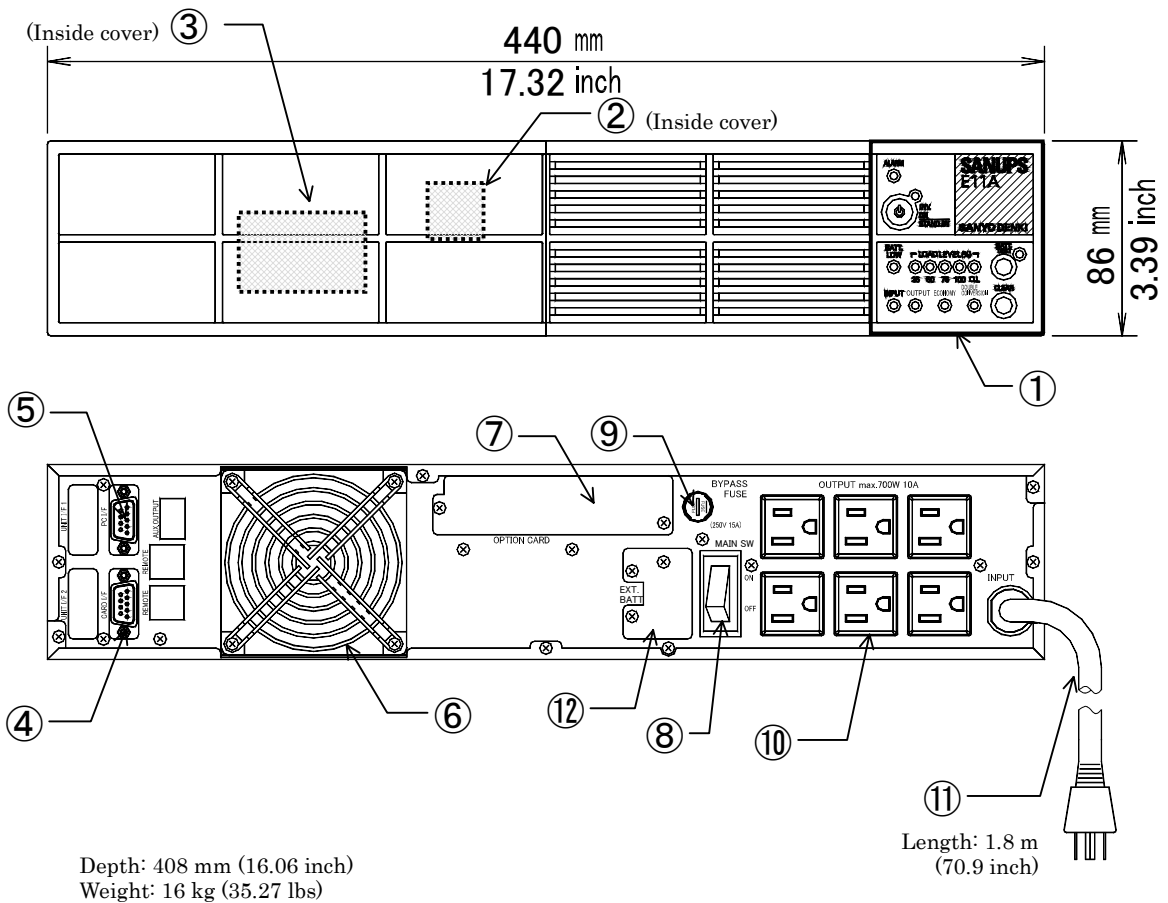

No.	Name	Label	Function
①	Control panel and indicators	—	Control panel for control operations, UPS status display, and function settings
②	Forced bypass switch	Forced Bypass	Switch to bypass UPS during maintenance
③	Battery connector	—	Battery connector
④	Card interface	CARD I/F	Connector for external signal transfer
⑤	PC interface	PC I/F	Connector for external PC-WS signal transfer
⑥	Exhaust vent	—	Ventilation
⑦	Option card slot	OPTION CARD	Option card slot
⑧	Input switch	MAIN SW	Input power On and Off switch
⑨	Bypass fuse	BYPASS FUSE	Fuse to protect bypass circuits
⑩	Output terminals	OUTPUT	Normal power output terminals
⑪	Input power plug	INPUT	Input power plug
⑫	External battery connector	EXT.BATT	Connector for external battery

5.2 Control Panel and Indicators

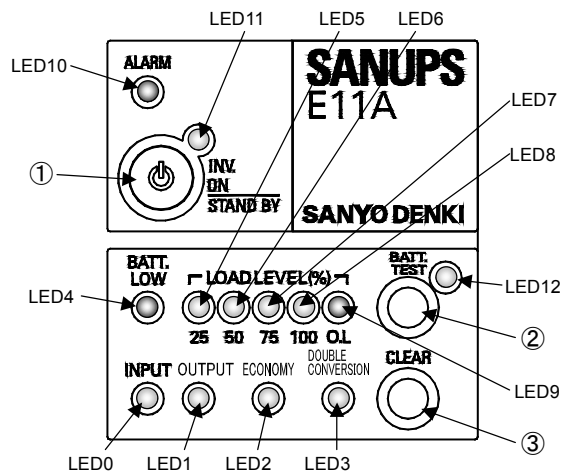

No.	Label	Functions				
		Status display	Lit	Not lit	Slow blink	Fast blink
LED0	INPUT	Input power status	Normal input	—	Input error	—
LED1	OUTPUT	UPS output power status	Inverter operation	OFF	Bypass operation	—
LED2	ECONOMY	Operation mode	Economy mode operation (*1)	OFF (*3)	—	—
LED3	DOUBLE CONVERSION	Operation mode	Double conversion mode operation (*2)	OFF (*3)	—	—
LED4	BATT.LOW	Battery status	Battery power low	Battery power normal	Battery exhausted	—
LED5	25	Load level 25%	Load 25% or more	Load under 25%	—	—
		Output voltage setting 100V (*4)	—	Setting other than 100V	100V setting	—
LED6	50	Load level 50%	Load 50% or more	Load under 50%	—	—
		Output voltage setting 110V (*4)	—	Setting other than 110V	110V setting	—
LED7	75	Load level 75%	Load 75% or more	Load under 75%	—	—
		Output voltage setting 115V (*4)	—	Setting other than 115V	115V setting	—
LED8	100	Load level 100%	Load 100% or more	Load under 100%	—	—
		Output voltage setting 120V (*4)	—	Setting other than 120V	120V setting	—
LED9	O.L.	Overload display	Load 105% or more	Load under 105%	—	—
LED10	ALARM	Alarm display	Failure detected	No failure	—	—
①	INV.ON/STAND BY	Inverter operation On/Off operation				
LED11	INV.ON/STAND BY	Inverter operation status	Inverter operation	Off	Bypass operation	—
②	BATT.TEST	Battery test				
LED12	BATT.TEST	Battery test	Result: Normal	—	Result: Error	Status: Testing
③	CLEAR	Stop buzzer, clear result of battery test				

※1. Economy mode operation·····When power conditions are good, UPS supplies this power to the load.

※2. Double conversion mode operation·····When power conditions fluctuate, UPS converts to the stable power, and supplies to the load.

※3. Active Filter Mode operation·····When load power fluctuates. Suppresses high frequencies generated by the load and improves power factor.

When the green DOUBLE CONVERSION and the green ECONOMY are both off, the UPS is in Active Filter Mode.

※4. The output voltage setting is displayed for about 5 seconds after the UPS is powered on (LED initialization display).

This manual uses a frame to indicate switches. (Example: INV.ON/STAND BY).

It also describes the color of the LED whenever it refers to an indicator on the control panel.

(Examples: Green INV.ON/STAND BY, red ALARM)

✱: Indicates a lit LED

In the illustrations in this manual

✱✱: Indicates a blinking LED

5.3 External Interfaces

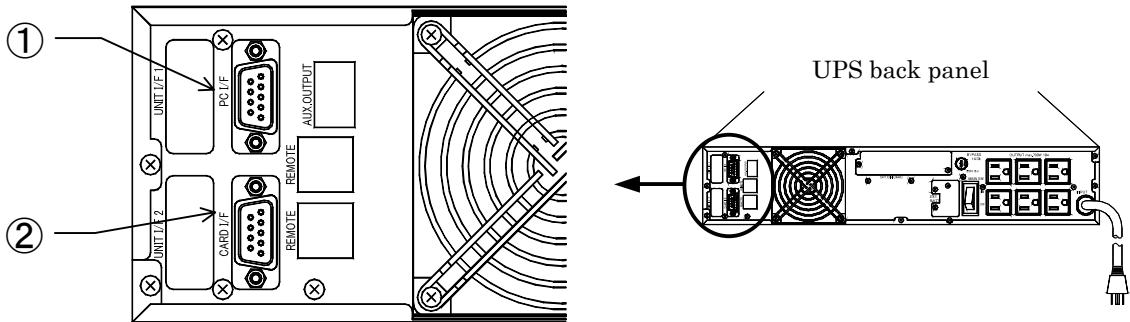

No.	Name	Function
①	PC I/F (PC interface) (RS-232C)	<p>Allows you to control the UPS from a computer (PC or workstation) by using the supplied power management software. Install the power management software (*2) on the computer, and connect the computer to the UPS with the supplied network cable.</p> <p>Interface mode (*1): Workstation mode</p> <p>(*1): Use the controls on the front panel to set the interface mode. For more information, see item ⑤ PC Interface mode in §10.1 “Setup Menu Item List”.</p> <div style="display: flex; justify-content: space-around;"> <div style="border: 1px solid black; padding: 5px;"> <p>2 RXD</p> <p>3 TXD</p> <p>5 GND</p> <p>4 DTR</p> <p>6 DSR</p> <p>8 CTS</p> <p>7 RTS</p> </div> <div style="border: 1px solid black; padding: 5px;"> <p>D-sub9-pin (male)</p> <p>Fixing screw inch</p> </div> </div> <p>(*2): For more information, refer to the User Guide in the CD-ROM of the SANUPS SOFTWARE.</p>
②	CARD I/F (Card interface)	<p>Allows you to connect an optional Sanyo LAN interface card.</p> <p>Interface mode (*1): Workstation mode</p> <p>Note This connector is for use with Sanyo option cards only.</p> <div style="display: flex; justify-content: space-around;"> <div style="border: 1px solid black; padding: 5px;"> <p>Cannot be used with other than Sanyo option cards.</p> <p>5 (COM)</p> <p>1 7V,1A/Option power</p> <p>2 RXD (in)</p> <p>3 TXD (out)</p> </div> <div style="border: 1px solid black; padding: 5px;"> <p>D-sub 9-pin (female)</p> <p>Fixing screw inch</p> </div> </div>

Note

The CARD I/F and PC I/F connectors cannot be used at the same time.

6. Installation



CAUTION

- When installing the UPS, carefully follow the instructions in this Instruction Manual.
- Install the UPS on a stable surface that can bear the weight (16 kg, 35.27 lbs). This surface should be flat, so the UPS cannot fall and cause bodily injury.
- The possibility of vibration and shock should be minimized at the installation location.
- All work that involves lifting the UPS, such as mounting it in a rack or attaching the stand, should be carried out by at least 2 persons.
- Be careful to avoid straining your lower back when moving and installing the UPS.
- There is a danger that the UPS could fall or be dropped during relocation or installation. Always hold the UPS securely by the upper edges. Failure to do so can result in bodily injury or damage to the UPS.

6.1 Environment

Do not install the UPS in the following locations:

- Where the ambient temperature exceeds 40°C (104°F).
For optimum battery life, install the UPS where the ambient temperature remains between 20 to 25°C (68 to 77°F).
- Where high humidity may occur.
- Where corrosive gas or salt spray may be present.
- Where it may be subject to vibration and shock.
- Where dust may accumulate.
- In a poorly ventilated rack (when the UPS is rack mounted).

6.2 Transporting

Transport the UPS in its original packing carton, removing it only when near the installation location.



CAUTION

When moving the UPS, do not let it tilt more than 10 degrees to either side. Tilting of more than 10 degrees can cause the UPS to fall, resulting in bodily injury. If you must tilt the UPS more than 10 degrees, be careful not to let it fall.

6.3 Installation Space

During installation, provide the following space around the UPS.

- At least 20 cm (about 8 inches) at the front as air intake space for cooling.
- At least 20 cm (about 8 inches) at the back as air exhaust space for cooling.
- At least 1 meter (about 40 inches) at the front and 50 cm (about 20 inches) at the back for maintenance when needed.
- At least 1 meter (about 40 inches) from CRT displays to allow for slight leakage of magnetic flux. Allow some space from devices which might be affected by magnetic flux.

Installation Space for Horizontal Installation

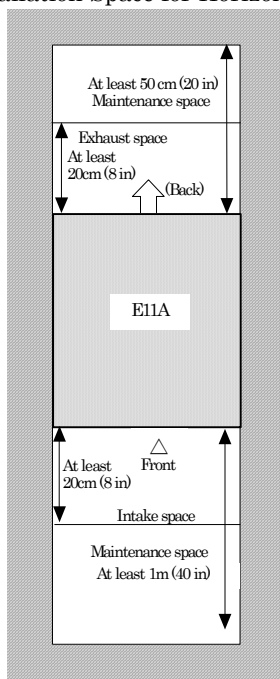

Installation Space for Rack Mounting

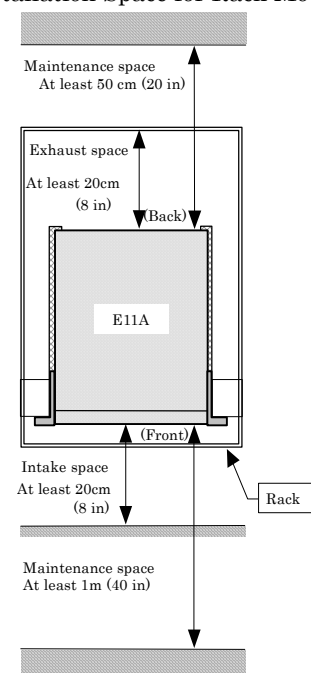

6.4 Preparation Before Installation



CAUTION

- Wear insulated gloves and take other precautions when connecting the batteries. Otherwise electric shock can result.
- There is a constant voltage (max. approx. 24V: approx. 12V × 2) at the battery terminals. Do not touch them with your hands or short circuit them. Bodily injury can result.
- The battery connector cannot be inserted in the wrong orientation. If it does not go in, do not try to force it. Doing so can damage the connector and result in electric shock.
- Be careful not to get your hands caught when securing the cover.

Connect the battery connectors inside the front cover before installation of the UPS. Proceed as follows to connect the battery connectors.

- ① Remove the front panel of the UPS.
- ② Remove the screw on the right side of the battery cover, and then remove the battery cover.
- ③ Remove the insulation tape from the battery connector of the battery pack side.
- ④ Connect the battery connector.

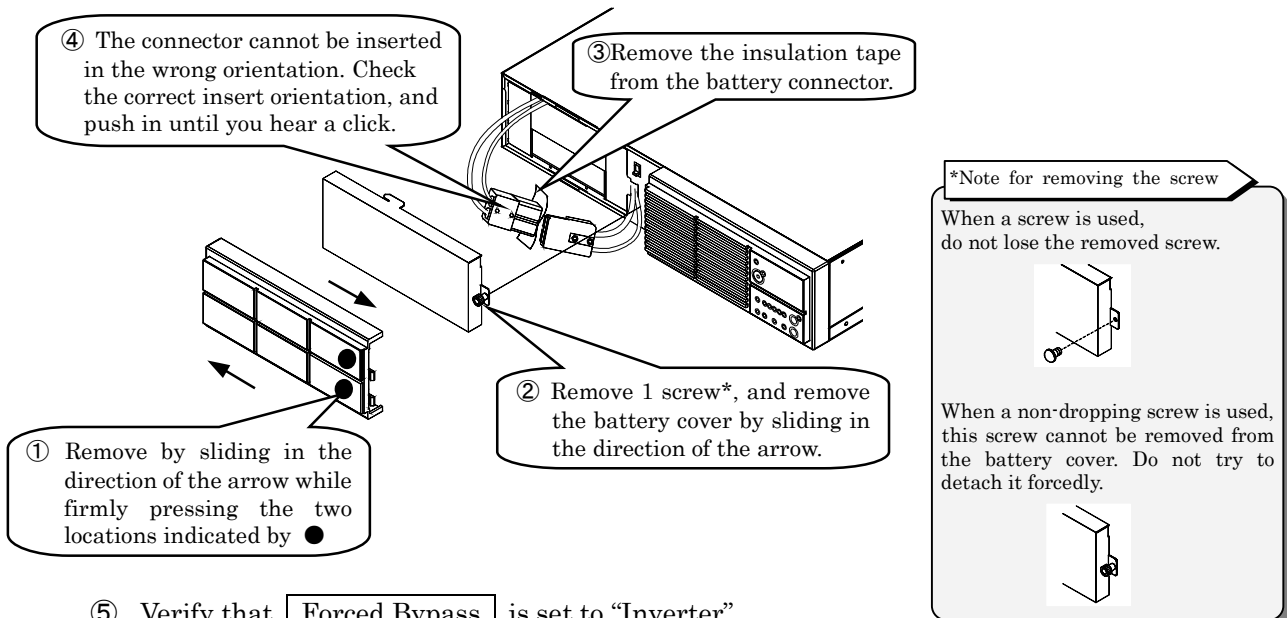

- ⑤ Verify that **Forced Bypass** is set to "Inverter".
- ⑥ Attach the battery cover.
- ⑦ Attach the front panel.

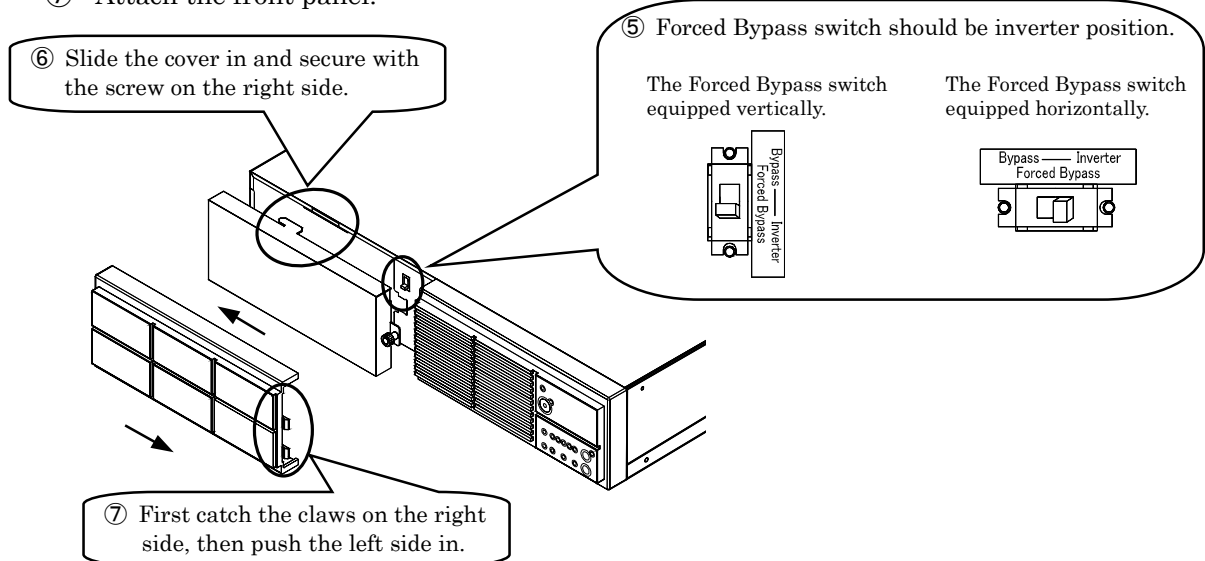

This completes the battery connector connection.

6.5 Attaching the Stand



CAUTION

- Unless the UPS is secured solidly in place, it can shift or fall during seismic events (earthquakes) or when it is subjected to shock or vibration, possibly causing bodily injury.
- Be careful not to get your hands caught when installing the stand.

Proceed as follows to attach the supplied stands.

- ① Prepare two supplied stands.

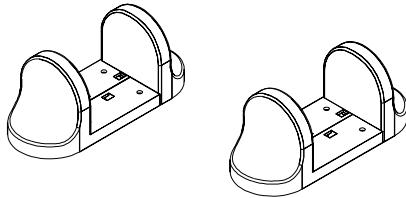

- ② Place the UPS in the stand.

Always place with the left side of the UPS on the bottom, and the control panel on the top.

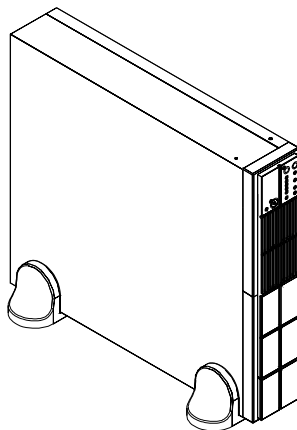

- ③ If required, secure the stand to the UPS with the screws.

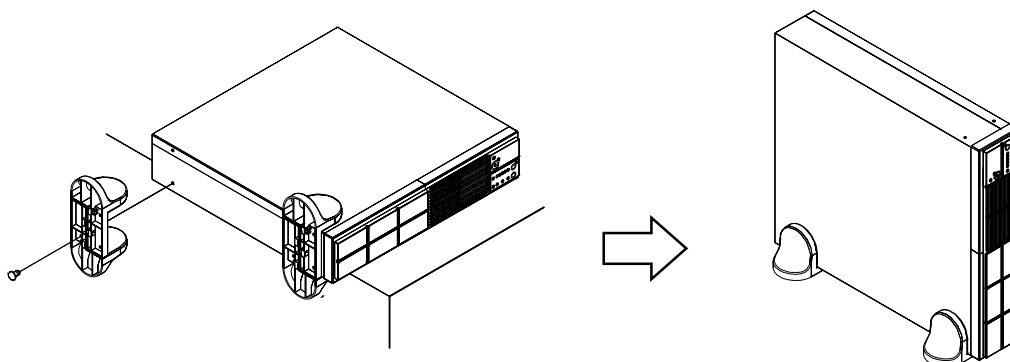

This completes the stand attaching.

6.6 Mounting a Rack Mount Type UPS



- Be careful to avoid straining your lower back when moving and installing the UPS.
- The UPS weighs about 16 kg (35.27 lbs). Always get at least one other person to help you install it. Bodily injury can result if the UPS falls.
- The UPS can fall when it is moved or installed, resulting in bodily injury or damage to the UPS. Hold the bottom side of the UPS firmly with both hands when installing it.
- For safety, use L-type rails (support rails) when mounting the UPS in a rack. (Contact the manufacturer of your rack for more information about L-type rails.)

The UPS is designed for mounting in 19-inch racks only. Refer to §6.3 “Installation Space” and make sure you secure enough ventilation space in front of and behind the UPS. Do not place other objects on top of the UPS. Doing so can damage the UPS.

The UPS is heavy, weighing about 16 kg (35.27 lbs). Installation at the very bottom of the rack is recommended. Always use L-type rails (support rails) when mounting the UPS in a rack. (Contact the manufacturer of your rack for more information about L-type rails.)

- ① Attach the supplied rack mounting brackets to the UPS.
There are 2 brackets, 1 for the left and 1 for the right. Refer to the following illustration and make sure you attach them in the correct direction.
- ② Mount the UPS in the rack.

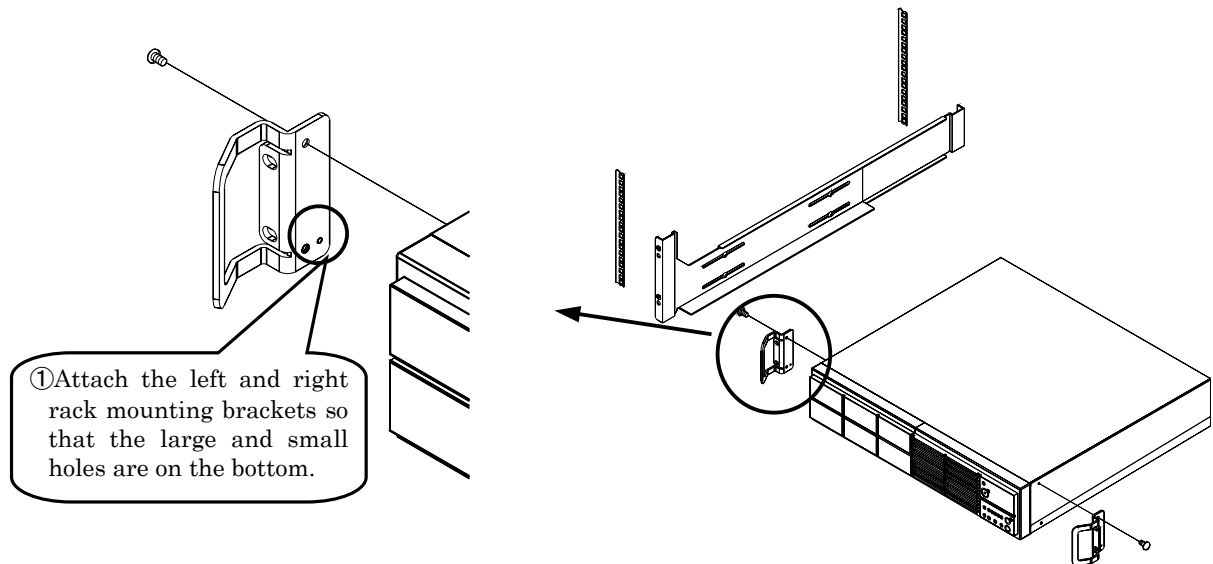

6.7 Inserting the Bushings

When you are not using the stand or rack mounting brackets, insert the supplied bushings into the holes on the UPS.

Left side: 4 locations

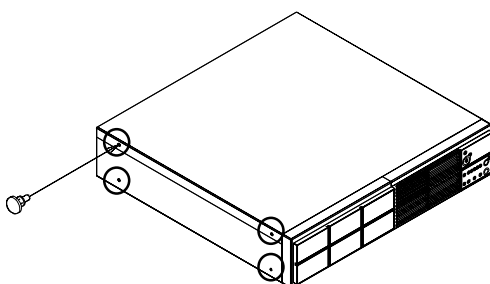

Right side: 2 locations

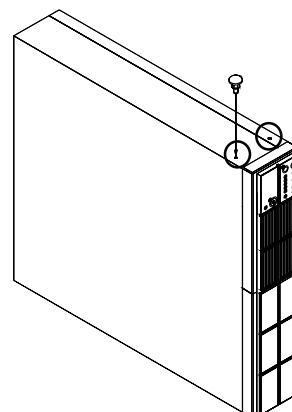

7. Wiring



CAUTION

- Check that input and output power plugs are firmly seated. Do not exceed the rated capacity when connecting loads to the output terminals. Check that plugs and cards are firmly seated in the external interfaces. Failure to observe these precautions can result in electric shock, fire, or bodily injury.
- The input power plug must be grounded. Failure to ground it can result in electric shock.



7.1 UPS Wiring

- ① Check that **MAIN SW** is in the "OFF" position.
- ② Connect the INPUT power plug of the UPS to a utility power outlet.

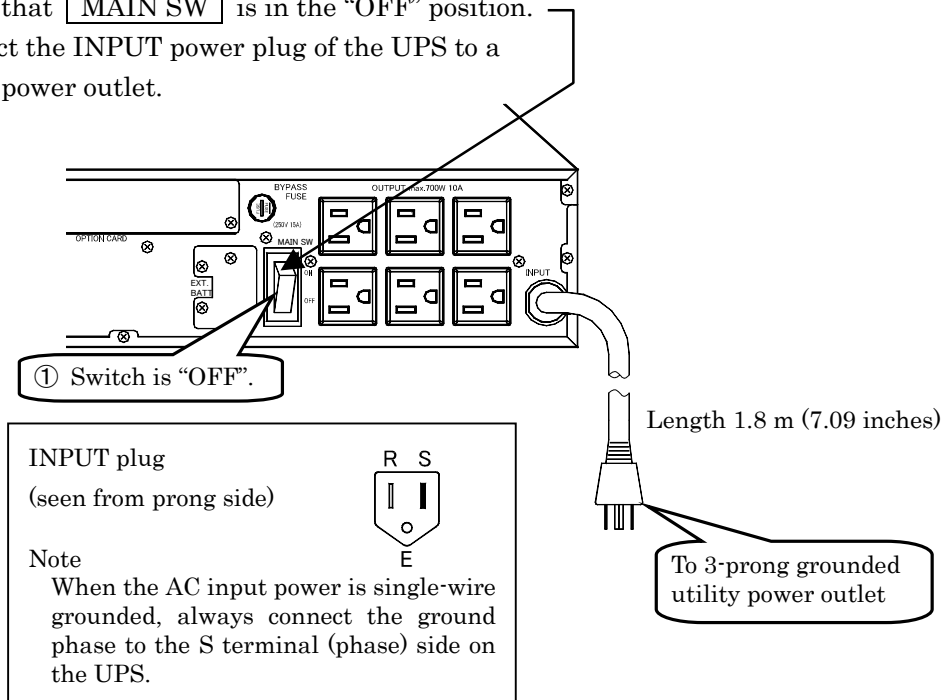

The INPUT power plug is a 3-prong grounded type.

If the utility power outlet is a 2-prong type (there is no ground terminal), use a 3-prong ground adapter such as WH2432P (Matsushita Electric) or ME2920 (Meikosha).

Adapter wiring example

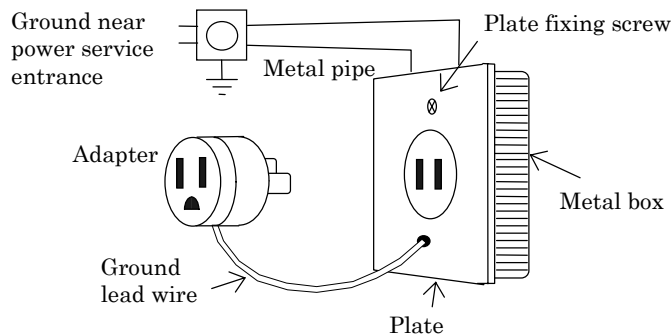

- ③ Connect the input power plugs of the load devices to the output terminals.

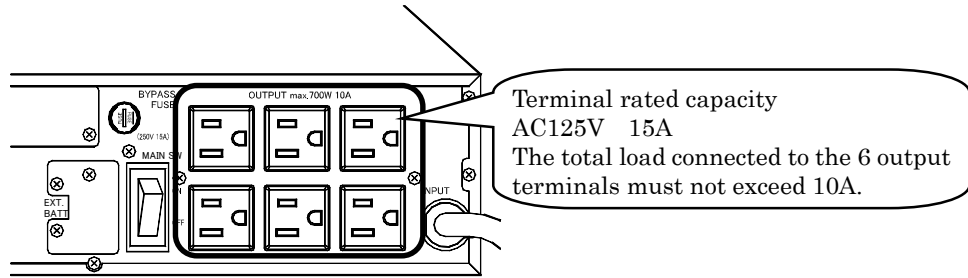

Output terminal capacity	Note
125V 15A terminal × 6	If you must make a single-wire grounded connection, always connect the ground phase to the V terminal (phase) side. <div style="float: right; text-align: center;"> </div>

Note
The total output from all output terminals must not exceed 10A.

7.2 External Interface Connections

Connect a computer or option card as required.
For details, see §5.3 “External Interfaces” and §10 “User Settings”.

Note
The CARD I/F and PC I/F connectors cannot be used at the same time.

7.2.1 Connections to the PC Interface (PC I/F)

Connect a computer to the PC I/F connector to control the UPS by using the supplied power management software.
Install the power management software on the computer, and connect the computer to the UPS with the supplied network cable. For more information, refer to the Install Guide or User Guide in the CD-ROM of the power management software.

Before making the connection, check that item ⑤ “PC Interface mode” in §10.1 “Setup Menu Item List” is set as follows.

Interface mode: Workstation mode

7.2.2 Connections to the Card Interface (CARD I/F)

Connected an optional LAN interface card.

Before making the connection, check that item ⑤ “PC Interface mode” in §10.1 “Setup Menu Item List” is set as follows.

Interface mode: Workstation mode

Note
This connector is for use with Sanyo option cards only. Contact your supplier for more information about option cards.

8. Preparations Before Operation

Check the following items before starting operation:

- ① Visually inspect the UPS to verify that there is no visible damage.
- ② Check that the UPS is connected to a utility power source that meets the input specifications.
- ③ Check that the input switch **MAIN SW** is set to “OFF”.
- ④ Check that load devices are connected correctly.
- ⑤ Check that none of the connections is loose.

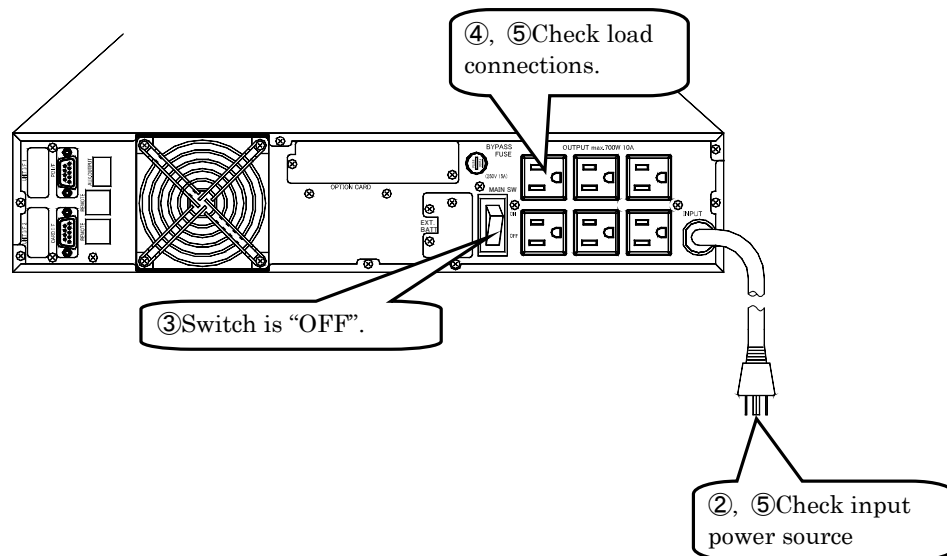

9. Operating Procedures

9.1 UPS Startup (Normal Operation)

① Set **MAIN SW** on the back panel of the UPS to “ON”.

①Set to “ON”.

LEDs	
Green INPUT	Blinking
Green INV.ON/STAND BY	Off
Green OUTPUT	Off
↓	
Green INPUT	Lit
Green INV.ON/STAND BY	Off
Green OUTPUT	Off

Check that the INPUT indicator has changed from blinking to lit, and then proceed to step ②.

② Press and hold **INV.ON/STAND BY** for one second.

Hold for 1 second.

Buzzer	
Musical trill	
LEDs	
Green INPUT	Lit
Green INV.ON/STAND BY	Lit
Green OUTPUT	Lit

- The green LOADLEVEL 25 to 100% indicators and the red LOADLEVEL O.L indicator light according to the load connected to the UPS.
- The green ECONOMY indicator lights when the UPS operating mode is Economy Mode.
- The green DOUBLE CONVERSION indicator when the UPS operating mode is Double Conversion Mode.
- When the green DOUBLE CONVERSION indicator and the green ECONOMY indicator are both off, the UPS is in Active Filter Mode.

This manual uses a frame to indicate switches. (Example: INV.ON/STAND BY). It also describes the color of the LED whenever it refers to an indicator on the control panel. (Examples: Green INV.ON/STAND BY, red ALARM)

In the illustrations in this manual

- Indicates a lit LED
- Indicates a blinking LED

9.2 UPS Startup (Battery Power)

During a power outage, low voltage, or other trouble with the AC input power to the UPS, you can supply power to the inverter output from the built-in batteries.

- ① Check that **MAIN SW** on the back panel is set to “OFF”.

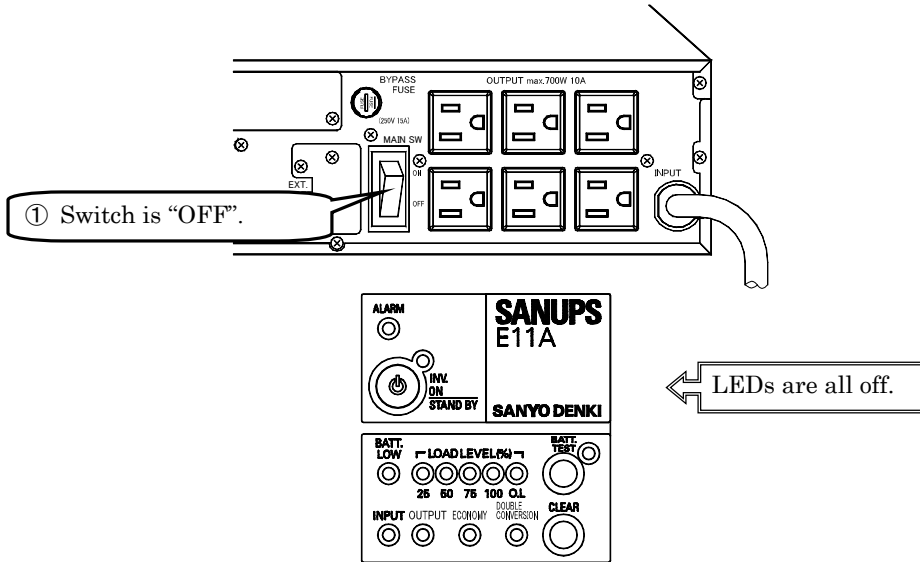

- ② Press  and hold it until the buzzer sounds. Release it when the buzzer sounds.

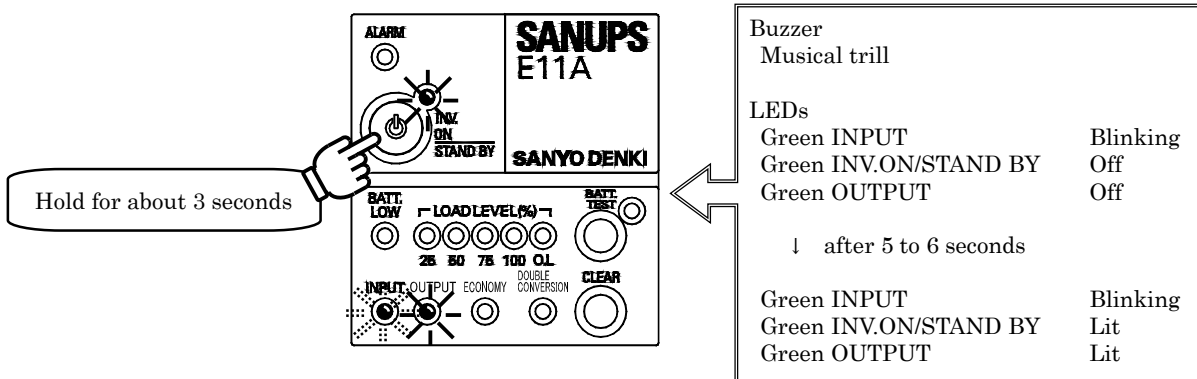

9.3 Outage Simulation Test

You should perform a test of whether the UPS operates properly during a power outage. Proper operation is as described below.

Note
Perform this test before powering the connected load devices on.

- ① Set the breaker on your utility power breaker panel to “Off”.

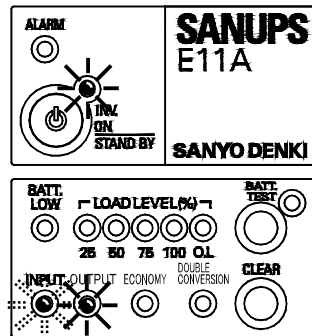

Buzzer
2 beeps..., 2 beeps..., repeated

LEDs
Green INPUT Blinking
Green INV.ON/STAND BY Lit
Green OUTPUT Lit

- ② Set the breaker on your utility power breaker panel to “On”.

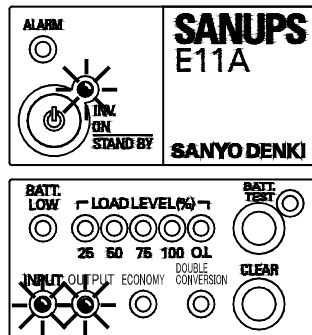

Buzzer
Silent

LEDs
Green INPUT Lit
Green INV.ON/STAND BY Lit
Green OUTPUT Lit

Note
If your utility power breaker panel is too far away to access conveniently, you can also perform the test by setting **MAIN SW** to the “OFF” and “ON” positions.
Because the UPS continues inverter operation, there is a small amount of voltage (under 30V) at the input plug. Do not unplug the plug during operation.

9.4 UPS Shutdown (Daily)

① Press and / hold  for 1 second.

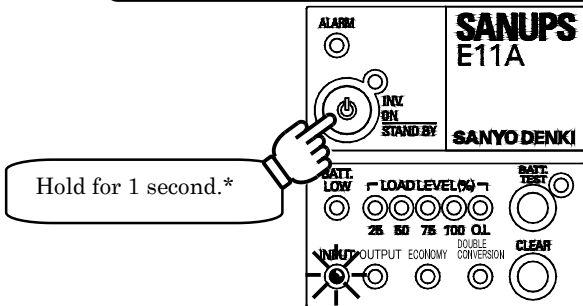



Buzzer	Musical trill
LEDs	
Green INPUT	Lit
Green INV.ON/STAND BY	Off
Green OUTPUT	Off

Note



Do not touch **MAIN SW** when you perform a daily shutdown. Leave it set to the “ON” position.

*Note

The length of time to keep  held down varies depending on the setting of item “⑨  switch response time” in §10.1 “Setup Menu Item List”. Operate as follows.

When “1 second” is selected: Hold for 1 second.

When “3 seconds” is selected: Hold for 3 seconds.

When “Special operation” is selected: Hold  for 3 seconds until the buzzer starts beeping, and then hold  for 3 seconds more while the buzzer is beeping.

9.5 UPS Shutdown (If Not to Be Used for More Than a Week)

① Press and hold  for 1 second.

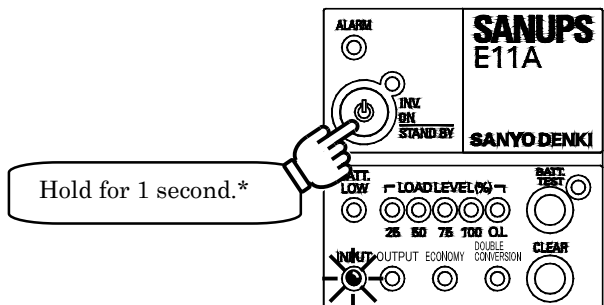

Buzzer	Musical trill
LEDs	
Green INPUT	Lit
Green INV.ON/STAND BY	Off
Green OUTPUT	Off

② Set **MAIN SW** to the “OFF” position.

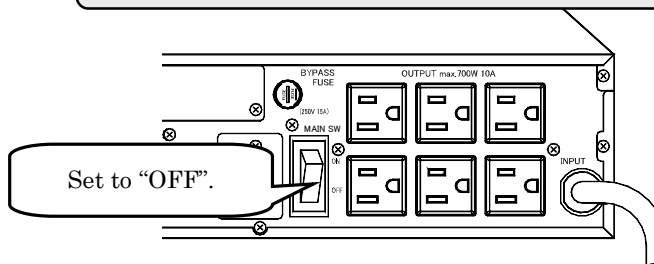
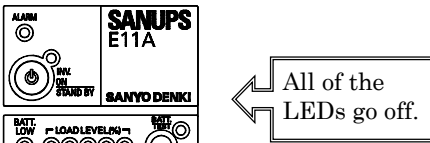
Note

If input power is shut off while the UPS is operating, the batteries are discharged the same as during an extended power outage. Be aware that when the input supply is restored, the full capacity of the back-up function will not be available until the batteries have had time to recharge.

10. User Settings

10.1 Setup Menu Item List

You can configure the UPS by setting the menu items in the following list. Configure it according to your environment and requirements.

The controls and indicators on the control panel are used to set items in the Setup menu. For details, see §10.2 “Setup Menu Operations”.

Whenever you change a menu item setting, we recommend that you place a check mark in the “Current Setting” field of the Setup Menu Item List.

● LED blinks
○ LED off

No.	Menu Item	Item Selection LEDs	Setting	Item Setting LEDs	Default Setting	Current Setting	Description	Notes
①	UPS operation mode	● ○ ○ ○ ○	Auto	● ○ ○ ○ ○	*		Switch the UPS operating mode automatically.	
			Double Conversion	○ ● ○ ○ ○			Set the UPS operating mode to Double Conversion mode.	
			Economy	● ● ● ○ ○			Set the UPS operating mode to Economy mode	
②	Output voltage (RESTART)	○ ● ○ ○ ○	100V	● ○ ○ ○ ○	Refer to the right		100V setting (The default setting of Model: E11A102U001-00.)	
			110V	○ ● ○ ○ ○			110V setting (The default setting of Model: E11A102U001-10.)	
			115V	● ● ● ○ ○			115V setting (The default setting of Model: E11A102U001-15.)	
			120V	○ ○ ● ○ ○			120V setting (The default setting of Model: E11A102U001-20.)	
③	Frequency sync range (RESTART)	● ● ○ ○ ○	1%	● ○ ○ ○ ○	*		±1% allowance	Set the range (%) over which the output frequency is adjusted to variations in the input frequency in Economy Mode and Active Filter Mode.
			3%	○ ● ○ ○ ○			±3% allowance	
			5%	● ● ● ○ ○			±5% allowance	
④	Battery startup frequency	○ ○ ● ○ ○	50Hz	○ ● ○ ○ ○	*		50Hz setting	Set the inverter output frequency when UPS restarts from the batteries from stopped status.
			60Hz	○ ● ○ ○ ○			60Hz setting	
⑤	PC Interface mode	● ○ ● ○ ○	Do not use this setting.	● ○ ○ ○ ○	*		—	Setting for communications by the power management software over serial or LAN connection.
			Workstation	○ ● ○ ○ ○			Shutdown by serial login.	
			Serial Login	● ● ● ○ ○			—	
			Do not use this setting.	○ ○ ● ○ ○			—	
⑥	Serial baud rate	○ ● ● ○ ○	9600	● ○ ○ ○ ○	*		Set the baud rate to 9600 bps.	Set the communications baud rate when a workstation, PC, or optional LAN card is connected.
			4800	○ ● ○ ○ ○			Set the baud rate to 4800 bps.	
			2400	● ● ● ○ ○			Set the baud rate to 2400 bps.	
⑦	Restart time (battery charge rate)	● ● ● ○ ○	Auto	● ○ ○ ○ ○	*		Auto restart	Specify when to restart the UPS after a power outage and shutdown of the UPS due to final discharge of the batteries. When 30%, 50%, or 80% is selected, the UPS does not restart until the batteries are charged to the specified level.
			OFF	○ ● ○ ○ ○			The UPS stays off.	
			30%	● ● ● ○ ○			Same behavior as Auto when battery charge reaches 30%.	
			50%	○ ○ ● ○ ○			Same behavior as Auto when battery charge reaches 50%.	
			80%	● ○ ● ○ ○			Same behavior as Auto when battery charge reaches 80%.	
⑧	Buzzer sound	○ ○ ○ ● ○	All patterns	● ○ ○ ○ ○	*		All sounds	Do not emit sounds on power outage, battery test, battery test abnormal and overload.
			Pattern 1	○ ● ○ ○ ○			Emit alarm and key click sounds.	
			Pattern 2	● ● ● ○ ○			Emit key click sounds only.	
			OFF	○ ○ ● ○ ○			—	
⑨	Switch response time	● ○ ○ ○ ○	1 second	● ○ ○ ○ ○	*		Turn inverter off when pressed for 1 second.	Set the response time for switch press to stop inverter power supply.
			3 seconds	○ ● ○ ○ ○			Turn inverter off when pressed for 3 seconds.	
			Special operation	● ● ● ○ ○			Turn inverter off on special operation. Select this setting to keep the inverter from being turned off by an accidental operation. See §9.4 “UPS Shutdown (Daily)” for operation details.	
⑩	Overload recovery operation	○ ● ○ ○ ○	Auto return	● ○ ○ ○ ○	*		Auto recovery with time	Set the conditions for automatic switch back to inverter power supply (auto return) after switching to bypass power supply because of overload.
			Bypass	○ ● ○ ○ ○			Fixed as bypass on overload	
⑪	Inverter stop Operation (RESTART)	● ● ● ○ ○	OFF	● ○ ○ ○ ○	*		The UPS stays off.	Specify the UPS operation during inverter power supply stops.
			Bypass	○ ● ○ ○ ○			Switch to bypass operation when inverter stops.	
⑫	Low battery voltage signal timing	○ ○ ● ○ ○	Battery voltage level	● ○ ○ ○ ○	*		When low battery voltage level is detected.	Specify the timing for triggering the low battery voltage signal.
			2 minutes	○ ● ○ ○ ○			When remaining battery capacity is 2 minutes.	
			3 minutes	● ● ○ ○ ○			When remaining battery capacity is 3 minutes.	
⑬	Battery backup time	● ○ ● ○ ○	5 minutes	● ○ ○ ○ ○	*		5 minutes backup	Set the UPS backup time on power outage. An external battery must be connected for settings of 15 minutes or higher. (This item can't take effect unless resetting remaining battery life.)
			15 minutes	○ ● ○ ○ ○			15 minutes backup	
			30 minutes	● ● ○ ○ ○			30 minutes backup	
			60 minutes	○ ○ ● ○ ○			60 minutes backup	
			180 minutes	● ● ● ○ ○			180 minutes backup	
⑭	Battery type	○ ● ● ○ ○	5 years	● ○ ○ ○ ○	*		5 years lifetime type	Set the battery type. Set this when you exchange the battery or connect an external battery. (This item can't take effect unless resetting remaining battery life.)
			10 years	○ ● ○ ○ ○			10 years lifetime type	
			3 years	● ● ● ○ ○			3 years lifetime type	
⑮	Battery check schedule	● ● ● ○ ○	180 days	● ○ ○ ○ ○	*		Check batteries every 180 days.	Set the interval (number of days) for the automatic battery check. The check is carried out automatically when the specified number of days has elapsed.
			90 days	○ ● ○ ○ ○			Check batteries every 90 days.	
			30 days	● ● ● ○ ○			Check batteries every 30 days.	
			None	○ ○ ● ○ ○			No battery check.	
⑯	Reset remaining battery life	○ ○ ○ ○ ●	Do not reset	● ○ ○ ○ ○	*		Do not reset.	—
			Reset	○ ● ○ ○ ○			Reset the battery information (remaining life, accumulated battery operating time, number of power outages, LED remaining life display), when you exchange the battery.	

Note

Changes to some menu items do not take effect until you restart the UPS. These items are indicated by (RESTART) in the “Menu Item” column. If a restart is required, be sure to power off the load devices before resetting. See §9.5 “UPS Shutdown (If Not to Be Used for More Than a Week)” for information about how to shut down the UPS, and §9.1 “UPS Startup (Normal Operation)” for information about how to start the UPS.

10.2 Setup Menu Operations

Set all menu items with the following procedure.

This example shows how to set the “UPS operation mode” item to “Economy”.

- With **MAIN SW** on the back panel set to “ON”, check that the green INV.ON/STANDBY indicator and the green OUTPUT indicators are not blinking.
- Press  and hold it for at least 3 seconds.

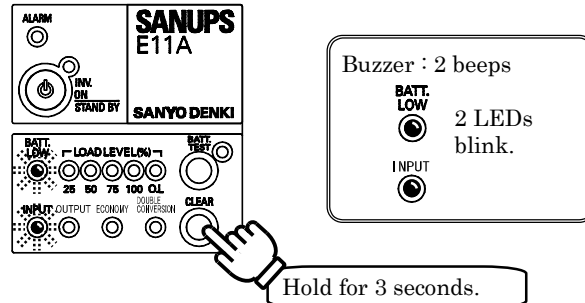

- Select the menu item to set by using the 5 LEDs surrounded by  in the following figure.

Press and quickly release  (within 3 seconds) so that a menu item selection LED blinks. Each press makes a different LED or set of LEDs blink. Keep pressing until you have selected the menu item you want to set.

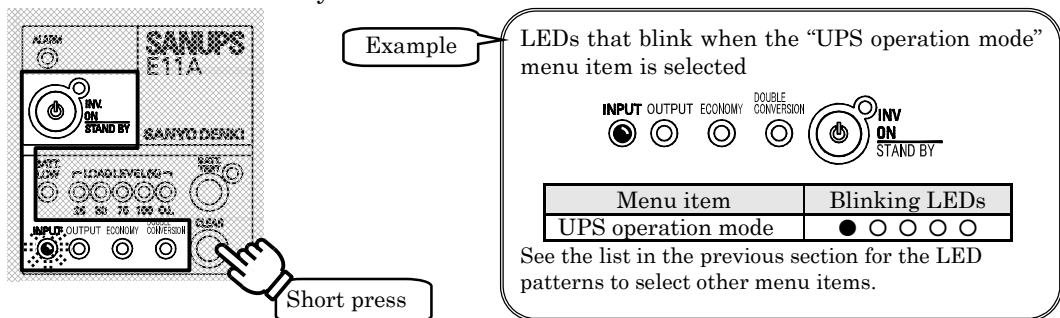

- Select the value to set by using the 4 LEDs surrounded by  in the following figure.

Press and quickly release  (within 3 seconds) so that a setting value LED blinks. Each press makes a different LED or set of LEDs blink. Keep pressing until you have selected the value you want to set.

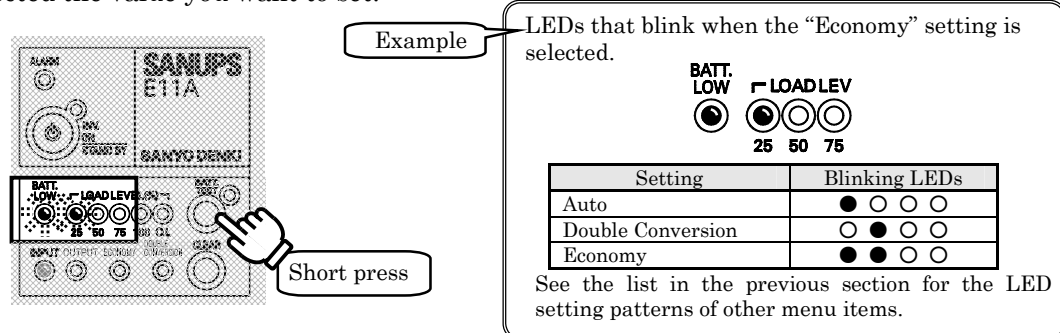

- When you are finished making settings, press  and hold it for at least 3 seconds.

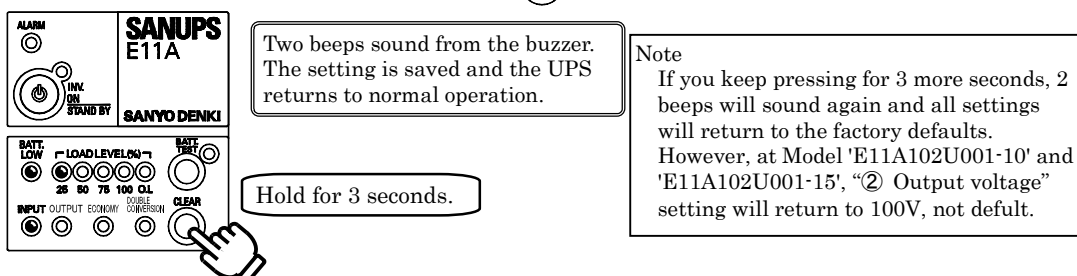

11. Maintenance and Inspection

11.1 Daily Inspection

Check the control panel LED indicators to confirm that no error is indicated.
No other special inspection or maintenance is required.

11.2 Periodic Inspection

Inspect the following items once every 6 months.

 CAUTION	<ul style="list-style-type: none">• Internal maintenance and inspection should be performed only by technically qualified personnel. Electric shock, injury, burning, fuming or fire could otherwise result.• Before beginning inspection, shut down the UPS completely, and remove the input power. Failure to do so may result in an electric shock.• While the batteries are connected to the equipment, hazardous voltage is present. Never touch any parts with your hand. Doing so may result in an electric shock.
---	---

- (1) Inspection of external appearance and internal visual check
Inspect the components on the circuit boards for signs of overheating or corrosion. This inspection is especially important if the equipment is installed in an environment subject to corrosive gases or high humidity.
- (2) Dust or dirt adhering to parts inside the UPS may cause it to malfunction. Remove any dust or dirt adhering to the intake and exhaust vents and fan.

11.3 Parts Replacement

The projected service life of the UPS is about 7 years. If you intend to continue using the UPS after its projected service life, contact your supplier regarding purchase of components that must be replaced. If the components are not replaced at the end of the service life, the UPS will not function properly.

- (1) Battery Once every 4.5 years
See §11.4 “Battery Maintenance” for more information about exchanging the battery.

<p>Note</p> <ul style="list-style-type: none">• The projected service life of the components is based on use in an ambient temperature of 25°C (77°F). Higher temperatures result in shorter service life.• Parts replacement should not be attempted by customers: contact your supplier or Sanyo Denki representative when replacement is needed.
--

11.4 Battery Maintenance



CAUTION

- Internal maintenance and inspection should be performed only by technically qualified personnel. Electric shock, injury, burning, smoke or fire could otherwise result.
- Batteries should be replaced periodically. Batteries used after their service life has passed may cause a fire.
- Never use organic chemicals such as gasoline, thinner, benzene or detergent to clean batteries. These can cause the casing to crack and leak, resulting in fire or current leakage.

(1) Battery backup time confirmation

Refer to §11.5 “Battery Test”, and periodically perform a battery backup time test. Depending on the results of the test, exchange the battery.

The default Setup menu setting is to perform an automatic battery test once every 6 months.

(2) Estimated battery replacement interval

Battery service life is affected by operating conditions such as ambient temperature and the number of discharge cycles. Ambient temperature has a particularly strong influence as indicated in the following table (refer to the table to predict when batteries will need to be replaced according to average ambient temperature). Using batteries after their service life has expired can cause leakage, and in the worst case damage may result, so we recommend exchanging batteries early as a preventative and protective step.

Average Ambient Operating Temperature	Projected Service Life	Battery Replacement Interval
25°C (77°F)	5 years	4.5 years
30°C (86°F)	3.5 years	3 years
35°C (95°F)	2.5 years	2 years
40°C (104°F)	1.7 years	1.5 years

(3) Battery specifications

The batteries in the UPS are specially designed for this application. Do not substitute with any other type, and do not mix new and old batteries, as shortened battery life, leakage, and heat could result.

(4) Battery disposal

Batteries are industrial waste containing lead, a toxic material and reusable resource. Please cooperate by recycling when replacing or disposing of used batteries. To dispose of used batteries, contact an authorized industrial waste handling company, or repack them in their original cartons and send them to your supplier.

11.5 Battery Test

You can perform automatic and manual tests of the built-in and externally connected batteries. You can do this without stopping the load devices connected to the UPS.

When it is shipped from the factory, the UPS is set up to perform an automatic battery test once every 6 months. To change the automatic battery test schedule, set item ⑮ “Battery check schedule” in §10.1 “Setup Menu Item List”.

Proceed as follows to perform a manual battery test.

Check that the batteries have been charged for at least 12 hours before performing the test.

- ① Press  and hold it for 2 seconds.

The green BATT. TEST indicator starts blinking, and the battery test starts.

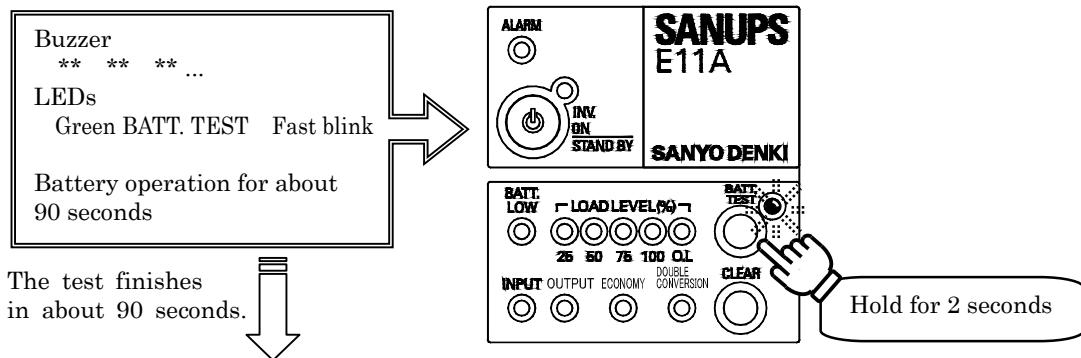

Check the green BATT. TEST indicator for the results of the test.

Battery Test Results

Display	Confirmed Backup Time	Result
Green BATT. TEST lit	90 seconds or more	The batteries are OK.
Green BATT. TEST slow blink Buzzer:***** ... ***** ... 7 beeps 7beeps	Under 90 seconds	An early battery exchange is recommended.

- ② After the battery test has finished and the green BATT. TEST indicator lights or starts blinking, press .

The green BATT. TEST indicator goes off and returns to its normal indication.

- ③ To stop the battery test while it is underway, press .

The UPS returns to normal operation.

The battery test stops if any of the following occur while it is underway.

- Input power error (voltage or frequency).
- Mechanical failure.
- Switching of **Forced Bypass** switch.
- Setting **MAIN SW** to “OFF”.
- Output power overload
- Pressing  for 1 second or longer.
- When stopping battery-test by power management software on the computer.
- When the LODE LEVEL indicators are all off (load factor is less than 20%) in the economy mode operation or the active filter mode operation.

The green BATT.TEST indicator does not display the results of the test if the test is interrupted.

Note

The results of the test are only an approximate guide. If the batteries have reached their replacement interval, an early replacement is recommended even if the results of the test are OK. See §11.4 “Battery Maintenance” for more information about the replacement interval.

11.6 Battery Exchange

You can exchange the batteries without stopping the load devices. However, this should be done as quickly as possible, because the UPS will be unable to provide backup power in the event of a power outage.

 CAUTION	<ul style="list-style-type: none">• The battery pack weighs about 6kg (13.23 lbs). Be careful not to drop it on your feet. Bodily injury can result.• Wear insulated gloves and take other precautions when exchanging the batteries. Otherwise electric shock can result.• There is a constant voltage (max. approx. 24V: approx. 12V × 2) at the battery terminals. Do not touch them with your hands or short circuit them. Bodily injury can result.
---	--

- ① Remove the front panel of the UPS.
- ② Remove the screw on the right side of the battery cover, and then remove the battery cover.
- ③ Disconnect the battery connector.
- ④ Pull the battery pack out.

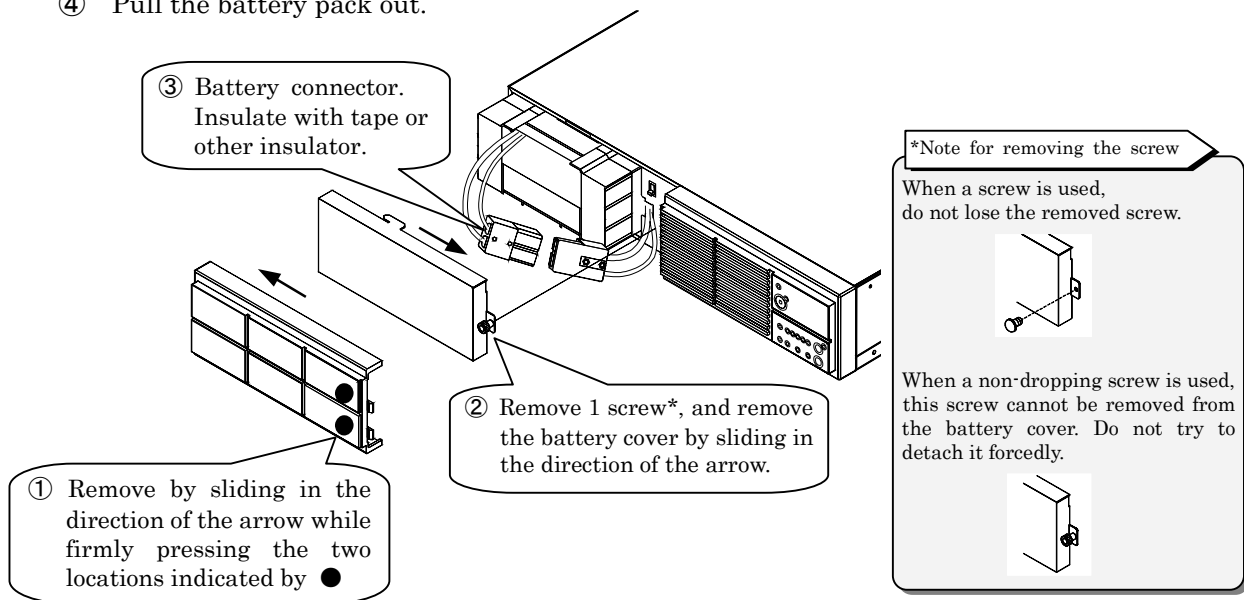

- ⑤ Insert the new battery pack so that the connector faces forward.
- ⑥ Connect the battery connector.

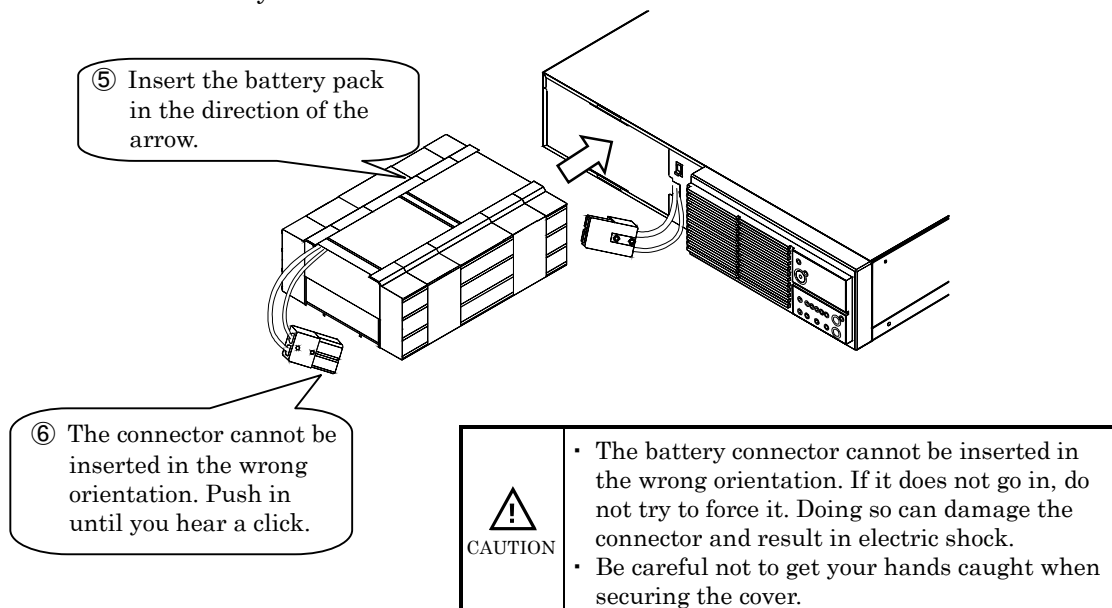

- ⑦ Attach the battery cover.
- ⑧ Attach the front panel.

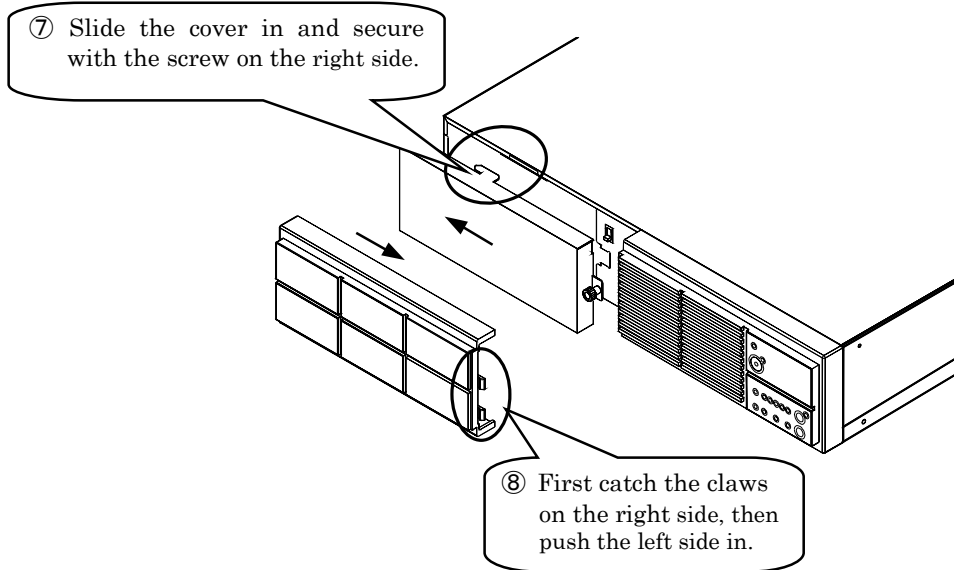

- ⑨ Rest the remaining battery service life with item ⑩ “Reset remaining battery life” in §10.1 “Setup Menu Item List”. For details, see §10 “User Settings”.

Battery disposal

Batteries are industrial waste containing lead, a toxic material. To dispose of used batteries, contact an authorized industrial waste handling company, or repack them in their original cartons and send them to your supplier.

This completes the battery exchange.



11.7 Bypass Fuse Exchange



Always power the UPS off before exchanging the fuse. Failure to do so can cause electric shock.
Be careful to avoid injury or electric shock.

If the bypass fuse blows, the red ALARM indicator lights and output from the output terminals stops.

Proceed as follows to exchange the fuse for a new fuse, using the supplied bypass fuse.

- ① Stop the inverter by pressing  and holding it for 1 second, and then set **MAIN SW** to “OFF”.
- ② Remove the fuse on the back panel of the UPS by pushing it in with a minus screwdriver and turning it in the counterclockwise direction.
- ③ Insert the new fuse, and return it to the original location by turning it in the clockwise direction.
- ④ Set **MAIN SW** to “ON”, and then start the UPS by pressing  and holding it for 1 second.

For details about UPS startup, see §9.1 “UPS Startup (Normal Operation)”.

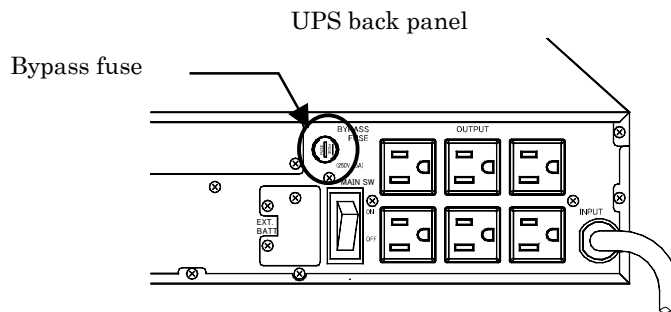

Note



- If you exchange the bypass fuse while the UPS is powered on, the red ALARM indicator will remain lit until you power the UPS off. Always power the UPS off before exchanging the fuse.
- Discard the old fuse as non-combustible industrial waste after exchanging it.

This completes the fuse exchange.

12. Troubleshooting

If a problem occurs, check the condition of the equipment and perform countermeasures as listed in the table below.

 CAUTION	<ul style="list-style-type: none"> Internal maintenance and inspection should be performed only by technically qualified personnel. Electric shock, injury, burning, fuming or fire could otherwise result. Before beginning inspection, shut down the UPS completely, and remove the input power. Failure to do so may result in an electric shock. While the batteries are connected to the equipment, hazardous voltage is present. Never touch any parts with your hand. Doing so may result in an electric shock.
---	---



Condition	Countermeasure
No power supplied to output.	<ul style="list-style-type: none"> Check whether the input wiring has been performed correctly. Refer to §7 “Wiring”. Verify that the input voltage and input frequency are within the rated range. Refer to §15.4 “Specifications”. Check that MAIN SW is set to “ON”.  must be pressed for at least 1 second. See §9.1 “UPS Startup (Normal Operation)” for the correct startup procedure. The bypass fuse may be blown. See §11.7 “Bypass Fuse Exchange”.
Output does not stop.	<ul style="list-style-type: none">  must be pressed for at least 1 second. See §9.4 “UPS Shutdown (Daily)” for the correct shutdown procedure. However, bypass power supply continues if bypass operation was started by changing over with the forced bypass switch, overload, or failure. Check the setting of item ⑪ “Inverter stop operation” in §10.1 “Setup Menu Item List”. It may be set to “Bypass”. The factory default setting is “OFF”. Check the setting of item ⑨  “switch response time” in §10.1 “Setup Menu Item List”. It may be set to “3 seconds” or “Special operation”. The factory default setting is “1 second”.
Output stops during operation	<ul style="list-style-type: none"> Check whether the bypass fuse on the back panel is blown. It may have been blown by an overload or short circuit. Check the total load and the possibility of a short circuit. When the total load is high, reduce the number of load devices connected to the UPS. See §11.7 “Bypass Fuse Exchange”.
Output stops during a power failure.	<ul style="list-style-type: none"> Check whether the batteries have reached their replacement interval. The battery service life will differ depending on the ambient temperature. Replacing the batteries early is recommended.
Alarm buzzer sounds.	<ul style="list-style-type: none"> The alarm buzzer sounds when an error, abnormal state, or alarm condition is detected in the UPS. See §13 “Alarm Sounds”.
Alarm buzzer does not sound.	<ul style="list-style-type: none"> The alarm buzzer sound may be set to “OFF”. Check the setting of item ⑧ “Buzzer sound” in §10.1 “Setup Menu Item List”.
Red ALARM LED is lit.	<ul style="list-style-type: none"> A non-fatal alarm condition or error has occurred. Contact your supplier.

Condition	Countermeasure
No recovery from utility power source failure. Utility power source failure occurs frequently.	<ul style="list-style-type: none"> • Check whether MAIN SW on the back panel of the UPS is in the “ON” position. (If MAIN SW is set to the “OFF” position during normal operation, the same operation as for a utility power source failure will be triggered.) See §9.1 “UPS Startup (Normal Operation)”. • Verify that input voltage and input frequency are within the rated limits. See §15.3 “Specifications”.
UPS does not switch from bypass operation to normal operation.	<ul style="list-style-type: none"> • Check whether the Forced Bypass switch is set to “Inverter”. This switch is located inside the front panel of the unit. Remove the front panel to check. See 14 “Maintenance Bypass Power Supply (Option)”. • When item ⑩ “Overload recovery operation” in §10.1 “Setup Menu Item List” is set to “Auto return”: The UPS switches to inverter operation every 2.5 seconds, and switches back to bypass power supply if the overload condition still persists. This cycle is repeated. • When item ⑩ “Overload recovery operation” in §10.1 “Setup Menu Item List” is set to “Bypass”: If the utility power voltage is low and the load current is below the overload detection threshold when the UPS switches to bypass power supply, the UPS continues to switch between inverter power supply and bypass power supply.
Cannot perform battery test.	<ul style="list-style-type: none"> • A battery test cannot be performed when: <ul style="list-style-type: none"> ① Inverter is stopped. ② Bypass power supply is active. ③ Input voltage or input frequency is out of range. ④ Shutdown under remote control is in progress. ⑤ Equipment is defective. ⑥ When the LODE LEVEL indicators are all off (load factor is less than 20%) in the economy mode operation or the active filter mode operation.
Serial communication fails.	<ul style="list-style-type: none"> • Verify that item ⑤ “PC Interface mode” in §10.1 “Setup Menu Item List” is set to “Workstation”. Check the serial connection. See §5.3 “External Interfaces”. • Check the setting of item ⑥ “Serial baud rate” in §10.1 “Setup Menu Item List”. The factory default setting of this item is “9600”.
Automatic inverter restart does not occur after shutdown due to battery exhaustion following power outage.	<ul style="list-style-type: none"> • Check the setting of item ⑦ “Restart time (battery charge rate)” in §10.1 “Setup Menu Item List”. Automatic inverter restart does not occur if this item is set to “OFF”. If this item is set to “30%”, “50%”, or “80%”, the UPS does not start until the batteries are charged to the specified level. The factory default setting of this item is “Auto”.
Green DOUBLE CONVERSION and green ECONOMY light and go off frequently at irregular intervals.	<ul style="list-style-type: none"> • The UPS is switching frequently between operating modes because the utility power is unstable. Set the UPS operating mode to “Double Conversion Mode”. For details, see item ① “UPS operation mode” in §10.1 “Setup Menu Item List”. The factory default setting of this item is “Auto”.

13. Alarm Sounds

The alarm buzzer emits sound patterns to alert you to failures and error conditions in the UPS. Check the sound pattern and refer to the following table to for the steps to take.

Press  to stop the buzzer sound.

Sound Pattern	UPS Status	What to Do
Continuous tone * _____	This is a mechanical failure.	Contact your supplier.
	During bypass operation The bypass fuse is blown.	Exchange the fuse for the supplied fuse. See §11.7 "Bypass Fuse Exchange".
	The battery is exhausted.	The UPS will restart automatically when utility power is restored.
2 seconds ** ** **... 2 beeps 2 beeps 2 beeps	Power is being supplied from the battery because of an input voltage or frequency error.	Input the correct voltage or frequency.
	The input switch MAIN SW was set to "OFF" during inverter power supply.	Set the input switch MAIN SW to "ON".
	The UPS is performing a battery check.	Wait for the battery check to end. You can stop the battery check by pushing  and holding it for 1 second.
Continuous beeps *****...	The battery voltage is low.	Input the correct voltage or frequency. Set the input switch MAIN SW to "ON".
1 second 2 seconds **** **** ****...	The load devices connected to the output exceed the rated capacity.	Connected fewer load devices to the output.
2 seconds ***** ***** 7 beeps 7 beeps	The battery check result was an error.	The battery must be exchanged. Contact your supplier.
2 seconds ***** *****... 5 beeps 5 beeps	The battery has reached half of its service life. The red BATT.LOW indicator lights.	A battery exchange is recommended. Contact your supplier. You can press  to stop the buzzer sound.
	The battery has reached its service life. The red BATT.LOW indicator blinks.	The battery must be exchanged. Contact your supplier. You can press  to stop the buzzer sound and red BATT.LOW blinking, but they will start again the next time the UPS is powered on. This will continue until you exchange the battery.

Note : Contact your supplier if any other failure occurs in the UPS.

14. Maintenance Bypass Power Supply (Option)

You can combine this UPS with an optional Maintenance Bypass Unit. In the event of a failure in the UPS, you can then exchange the UPS after manually switching from bypass power supply to maintenance bypass power supply.

Note

The following description applies to use with an optional Maintenance Bypass Unit.

Normally, do not change the setting of the **Forced Bypass** switch. Leave it set to the “Inverter” side.

If you do set the **Forced Bypass** switch to the “Bypass” side, to perform maintenance or for some other reason, remember to set it back to the “Inverter” side when resuming normal operation. After setting it back to the “Inverter” side, press  on the control panel and hold it for at least 1 second.

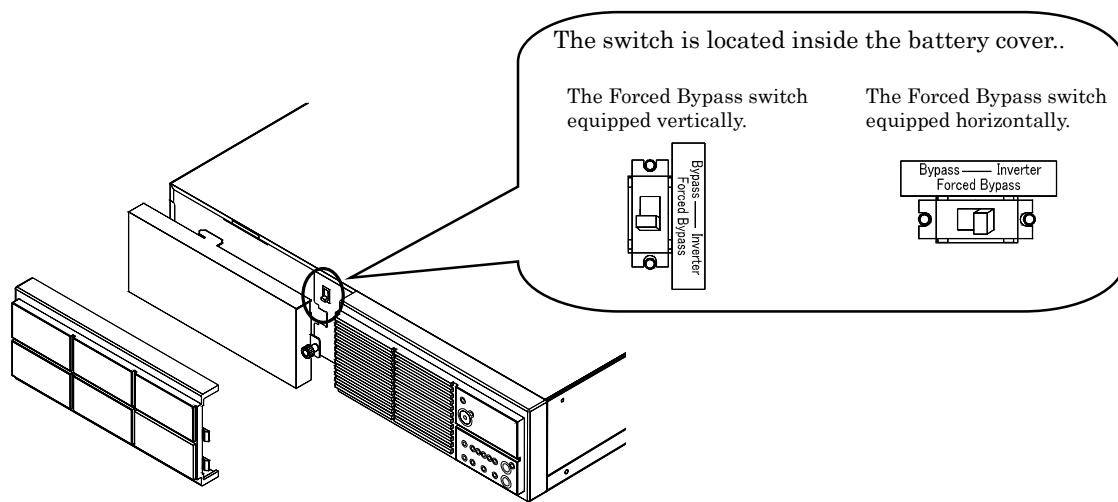

15. Functional Description

15.1 Basic Operation

(1) Normal Operation

In normal operation, the UPS switches automatically* between the three modes (a) to (c) depending on the state of the power.

* The UPS does not switch automatically when item ① “UPS operation mode” in §10.1 “Set Menu Item List” is set to “Double Conversion” or “Economy”.

(a) Active Filter mode

The UPS operates in Active Filter mode when the input power voltage is within a certain range and the output power factor is below a certain value. In Active Filter mode, the UPS receives power from the utility power source and supplies it to the load. At the same time, it compensates for high frequencies in the input power at the inverter. The batteries are kept continually charged and ready in case a problem (outage or voltage drop) occurs in the utility supply.

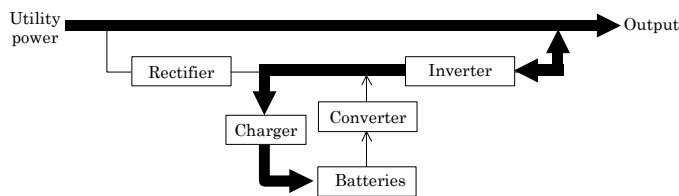

Power supply route in Active Filter mode

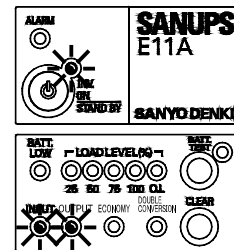

Indications by LEDs

(b) Double Conversion mode

The UPS switches to Double Conversion mode when the input power voltage is outside a certain range. In Double Conversion mode, the UPS converts AC power from the utility power source into DC power through the rectifier, and reconverts this DC power back into AC power through the inverter and supplies it to the load. The output power is stable AC power synchronized with the input power source. The batteries are kept continually charged and ready in case a problem (outage or voltage drop) occurs in the utility supply.

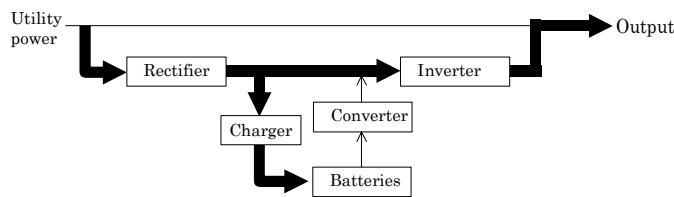

Power supply route in Double Conversion mode

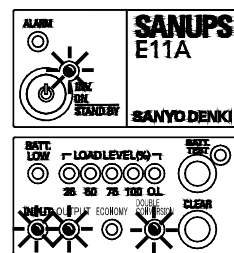

Indications by LEDs

(c) Economy mode

The UPS switches to Economy mode when the input power voltage is within a certain range and the output power factor is above a certain value. In Economy mode, the UPS receives power from the utility power source and supplies it to the load. At the same time, the inverter is connected to the load and ready to activate. The batteries are kept continually charged and ready in case a problem (outage or voltage drop) occurs in the utility supply.

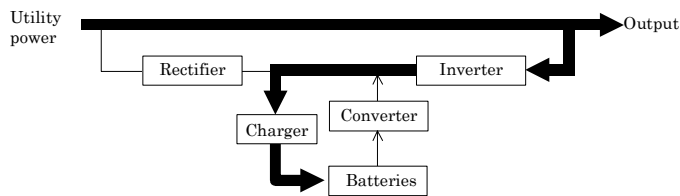

Power supply route in Economy mode

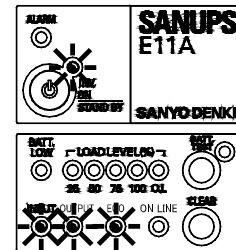

Indications by LEDs

(2) On Failure of Utility Power

When a fault or an outage occurs in the utility power source, the rectifier and charger cease operating while inverter operation continues, now using the batteries as a DC source to produce AC voltage, to ensure stable power supply to the load without even a momentary power dropout. At the same time, the buzzer sounds the battery operation alarm, and the green INPUT indicator starts blinking.

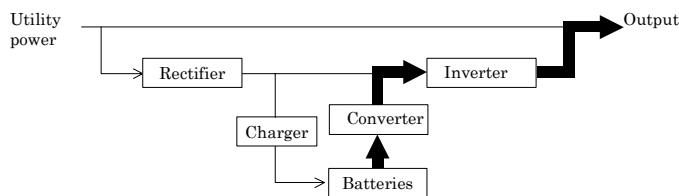

Power supply route on failure of utility power

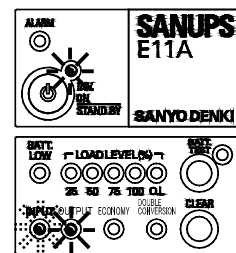

Indications by LEDs

(3) Upon Recovery of Utility Power

When normal utility power is restored, rectifier and charger operations resume automatically, returning to the normal operating state described in §15.1 (1).

(4) When Battery Voltage Declines

When low voltage or an outage in the utility power source continues, causing the battery voltage to decline to about 22V (1.85V/cell), the red BATT.LOW indicator in the above figure lights to indicate low battery voltage.

Note: When item ⑫ “Low battery voltage signal timing” in §10.1 “Setup Menu Item List” is set to “2 minutes” or “3 minutes”, the alarm is issued at the point when the remaining battery time drops to the specified level.

(5) Extended Power Outage

If a power outage persists and the battery voltage reaches the final discharge level, a protective circuit shuts off the inverter to prevent over-discharging of the batteries. When normal utility power recovers after the inverter has been stopped automatically, operation is automatically resumed, returning to the normal operating state described in §15.1 (1).

Note: When item ⑦ “Restart time” in §10.1 “Setup Menu Item List” is set to “OFF”, inverter output remains stopped. When it is set to “30%”, “50%”, or “80%”, the UPS restarts operation once the batteries are charged to the specified level and then returns to the normal operating state described in §15.1 (1).

15.2 Protective Functions

(1) Overload Protection

If the UPS output is overloaded by exceeding the current capacity of the inverter, such as when a computer system boots up, the output selector switch automatically switches the source of AC power from the inverter to the bypass circuit, without interruption. After a certain period of time has elapsed, the source of power to the load is switched back to the inverter without interruption (auto-return), as shown in §15.1(1).

Note: When item ⑩ “Overload recovery operation” in §10.1 “Setup Menu Item List” is set to “Bypass”, the UPS switches to inverter power supply without interruption when the overload is resolved.

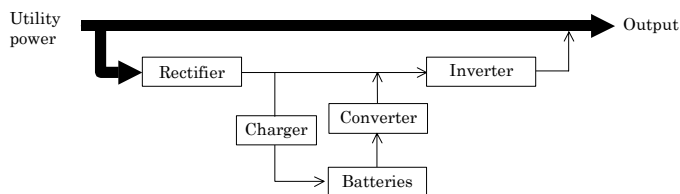

Power supply route on failure of utility power

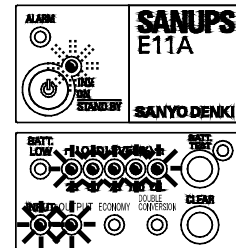

Indications by LEDs

(2) Inverter Fault Protection

If a fault occurs in the inverter, the output selector switch activates automatically and switches from inverter power to bypass power without interruption. The red ALARM indicator lights, and the alarm buzzer sounds. The power supply route is the same as for an overload. Press  to stop the buzzer.

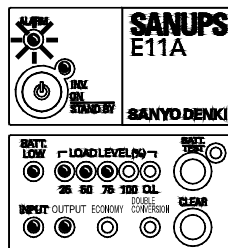

LED indications when an inverter fault occurs

Note: What to do if an inverter fault occurs

Output from the UPS will stop if a power outage occurs during bypass operation due to an inverter fault. Contact your supplier or a Sanyo Denki representative as soon as possible.

15.3 Protective Function Table

The following table shows functions and operations which activate to protect the UPS.
The ○ mark indicates lit LEDs and buzzer alarms.

Item	Operation panel (front panel) indicators						Alarms	Protective functions (UPS operations)	Notes	
	INPUT Green	OUTPUT Green	INV.ON STAND BY Green	ALARM Red	O.L Red	BATT. LOW Red	Buzzer pattern (*1)			
Preparation	○	(*2)	(*2)	—	—	—	—	Rectifier, charger, operation	Power up	
Normal	○	○	○	—	—	—	—	Inverter operation	Power up, operation	
Serious failure	○	○ Blink	○ Blink	○	—	—	○ (1)	Stop inverter Bypass supply		
Overload (effective value)	○	○ Blink	○ Blink	—	○	—	○ (4)	Bypass supply	Auto return	
Forced bypass	○	○ Blink	○ Blink	—	—	—	—		Manual switch to bypass supply	
Input over voltage	○ Blink	○	○	—	—	—	○ (2)	Stop rectifier and charger Continue inverter supply.	Battery operation	
Input over voltage (prolonged)	○ Blink	○	○	—	—	○	○ (3)		Battery operation (*3)	
Power outage	○ Blink	○	○	—	—	—	○ (2)		Battery operation	
Power outage (prolonged)	○ Blink	○	○	—	—	○	○ (3)		Battery operation (*3)	
Input error (frequency)	○ Blink	○	○	—	—	—	○ (2)		Battery operation	
Input error (prolonged)	○ Blink	○	○	—	—	○	○ (3)		Battery operation (*3)	
Battery failure	○	○ Blink	○ Blink	○	—	○	○ (1)		Stop inverter Bypass supply	

(*1): Press  on the front panel of the UPS to stop the buzzer. If a failure occurs, contact your supplier or Sanyo Denki representative as soon as possible.

Buzzer sound patterns:

- (1) * ————— Continuous tone
- (2) ** **
- (3) ***** Continuous beeps
- (4) **** ****

(*2): In this state, the LED blinks or is off, depending on the setting of item ⑪ “Inverter stop operation” in §10.1 “Setup Menu Item List”.

When item ⑪ is set to “Bypass”: ○ Blinks

When item ⑪ is set to “OFF”: —

(*3): Battery operation. Stops inverter operation when final battery discharge is reached.

15.4 Specifications

Item	Standard or Performance	Notes		
Output capacity	1kVA/0.7kW			
Cooling system	Forced air cooling			
AC input	Phases	Single phase, 2-wire		
	Voltage	100,110,115,120V -20% to +15% Double Conversion mode operation ±5% Economy /Active Filter mode operation ±10% Economy mode setting	User settable (Rated voltage same as output voltage)	
	Frequency	50Hz or 60Hz	±8%: Double Conversion mode operation ±1, 3, 5%: Economy /Active Filter mode operation	
	Power requirements	0.9kVA	Max. capacity during battery charging	
	Input power factor	0.95 or more	During rated output (*2)	
AC Output	Phases	Single phase, 2-wire		
	Voltage	100, 110, 115, 120V	User settable	
	Voltage regulation	Rated voltage ±2%		
	Rated frequency	50Hz or 60Hz	Same as input frequency (auto selection)	
	Frequency regulation	Rated frequency ±1%: Double Conversion mode Setting Rated frequency ±1, 3, 5%: Economy/Active Filter mode operation	1, 3, 5% selectable Internal oscillator accuracy ±0.5%	
	Voltage waveform	Sine wave		
	Distortion factor of voltage waveform	Linear load: 3% or less 100% rectifier load: 7% or less	During rated output	
	Transient voltage variation	Rapid load change	Rated voltage ±5 %	0% ⇔ 100% at transient or output switch
		Power outage, recovery		During rated output
		Rapid input voltage change		±10% variation
	Response time	5 cycles or less		
	Load power factor (lag)	0.7 (lag)	Variation range 0.7 (lag) to 1.0	
	Overcurrent protection	Auto switch to bypass circuit at 105% or more	With auto return function	
	Overload capability	Inverter	105%	200ms
		Bypass	200%	30 seconds
800%			2 cycles	
Batteries	Type	Small sealed lead battery		
	Rated capacity	10 A·h (equivalent)	20 hour ratio	
	Number	2 (12V per battery)	2 in direct series	
	Backup time	5 minutes (700W) 10 minutes (500W)	At 25°C (77°F) ambient temperature, rated load	
Generated heat	50W			
Input leakage current	3mA or less			
Operating environment	Ambient temperature: 0 to 40°C (32 to 104°F) Relative humidity: 20 to 90%	(*3)		
Acoustic noise	40 dB or less	1 m (approx. 40 inches) from UPS front panel, 'A' characteristics (linear load)		

(*1): The inverter is capable of operation synchronized with AC input and instantaneous switchover provided that the AC input frequency is within ±3% (or 1%, 3%, 5%, selectable) of the rated frequency, and the AC input voltage is within +15% to -20% of the rated voltage.

The UPS enters battery operation with the AC input frequency is outside the specified range.

(*2): When input voltage waveform distortion is under 1%.

(*3): The UPS contains batteries. Battery service life will be foreshortened if the UPS is used in an environment where the ambient temperature exceeds 30°C (86°F).

(*4): If grounded, the ground phase of the input and output must match according to UPS specifications.

(*5): The above table lists standard specifications. Some specifications are different for units with long backup times. For details, refer to the external battery specification instruction manual.

16. Warranty

Warranty for Use Overseas (North America) 3 Years

1. This product is warranted against electrical failure due defects in materials or workmanship for 3 years after the date of purchase.
2. Free repair or replacement by a product with equivalent functions will be made when it is determined that failure has occurred because of defects in materials or workmanship.
3. This warranty is void in the event of any modification or change to the product supplied by Sanyo Denki.
4. This warranty is void in the event of any improper use of the product supplied by Sanyo Denki, or failure to use the product as specified in this Instruction Manual.
5. This warranty is void in the event that the product supplied by Sanyo Denki is installed in an inappropriate location.
6. This warranty does not apply to failures due to accidents, improper use, or use for other than the product's intended use.
7. This warranty does not apply to defects or damages arising from fire, earthquake, storm or flood disaster, lightning or other natural disasters including pollution, salt disaster, gas disaster (chloride gas), non-standard voltage or incorrect power sources other than those specified.
8. This warranty does not apply to defects or damages arising from mishandling, such as during transportation, relocation or dropping of the UPS by the customer after purchase.
9. Sanyo Denki reserves the right to determine whether damage to a load device connected to this product is due to faulty operation by this product. (In the event of any such claim, the affected load device must be sent to Sanyo Denki for inspection.)
10. Warranties for devices other than the product supplied by Sanyo Denki shall be the warranties provided by the manufacturers of those devices.
11. Sanyo Denki provides no warranty for products made by other manufacturers (e.g. batteries).
12. This warranty applies to the product specified by Sanyo Denki. It does not apply to any other device.
13. Sanyo Denki disclaims all responsibility for damage to load device software, loss of data, lost profits, and lost opportunities.
14. This warranty does not apply to medical or industrial devices connected to this product.
15. This warranty applies only to devices installed in the United States of America and Canada.

Appendix Usage notes for SANUPS SOFTWARE STANDALONE

When using supplied “SANUPS SOFTWARE STANDALONE”, please note the following instructions.

“Charge” on the main screen of “SANUPS SOFTWARE STANDALONE”

For the charge rate (as a %) of the battery displayed on the main screen of “SANUPS SOFTWARE STANDALONE”, please note the followings.
Refer to §6.1 “Main Screen” in the User Guide of SANUPS SOFTWARE STANDALONE for details.

1. Proceed as follows to charge the batteries of the UPS for 12 hours or more at initial startup of the UPS.

Perform this operation before powering the connected load devices on.

- ① Verify that the battery connector is connected correctly.
See §6.4 “Preparation Before Installation” in the E11A Instruction Manual for details.
 - ② Perform step “§9.1 ①” in the E11A Instruction Manual.
 - ③ Verify that the Green INPUT LED on the UPS control panel lights.
Charging starts automatically.
 - ④ Keep the UPS in the condition of step ③ for 12 hours or more.
2. If the UPS is stopped and then restarted, even when the UPS is charged by step 1, “Charge” might be displayed as “80%” or “90%” not “100%” on the main screen.
This occurs owing to the operating conditions such as ambient temperature.
However after normal operation of the UPS for 1 or 2 hours, “Charge” is displayed properly.
3. Connect the battery connector correctly. If the UPS is operated without the batteries, “Charge” is not displayed properly. Moreover, even if the battery connector is reconnected and operates the UPS, the proper charge rate is not displayed immediately.
After normal operation of the UPS for 12 hours or more, “Charge” is displayed properly.
4. Display of “Charge” is only an approximation. An actual charge rate of the battery might be different.

“Backup Time” on the main screen of “SANUPS SOFTWARE STANDALONE”

For the presumed “Backup Time” (in minutes) displayed on the main screen of “SANUPS SOFTWARE STANDALONE”, please note the followings.
Refer to §6.1 “Main Screen” in the User Guide of SANUPS SOFTWARE STANDALONE for details.

1. In §6.4 (1) “Setting the shutdown trigger conditions”, if “When the battery-low occurs, shutdown execution” is selected as the shutdown trigger conditions, set the time more than 40% of the presumed backup time displayed on the main screen.
Refer to §6.4 “Setting the Shutdown Conditions” in the User Guide of SANUPS SOFTWARE STANDALONE for details.
2. If the “Load” displayed on the main screen is less than 30%, the presumed backup time sometimes shows improper value. Therefore “When the battery-low occurs, shutdown execution” feature is not recommended to use with such a low load factor condition.
3. The presumed backup time is only an approximation. An actual backup time might be different.

LED blinking for setting up menu

For the following two Menu Item,

- “Restart time (battery charge rate)” in the E11A Instruction Manual §10.1 “Setup Menu Item List No.⑦”.
- “Low battery voltage signal timing” in the E11A Instruction Manual §10.1 “Setup Menu Item List No.⑫”.

when confirming two items using control panel of UPS, the positions of the LED blinking for setting up menu might be different from description in the E11A Instruction Manual.

Refer to §10.2 “Setup Menu Operations” in the Instruction Manual of E11A to confirm the Menu Item.

These might be blinking as follows.

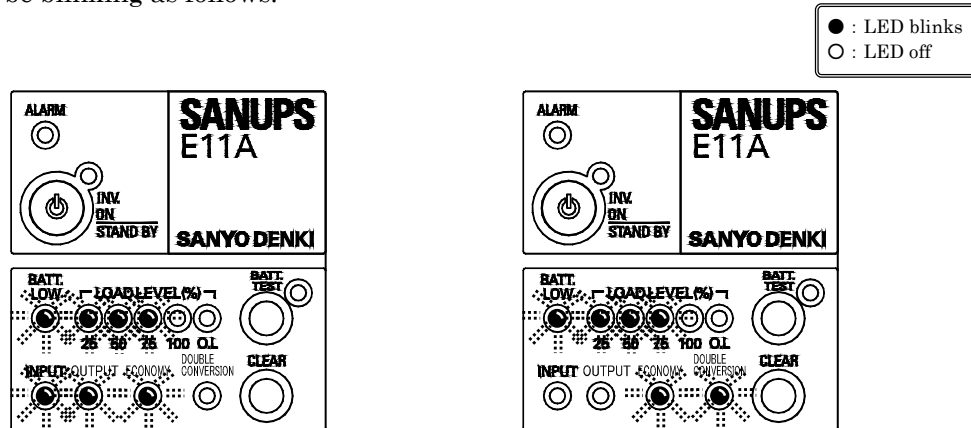

“Restart time (battery charge rate)” setting “Low battery voltage signal timing” setting

When using “SANUPS SOFTWARE STANDALONE”, menu item setting of “SANUPS SOFTWARE STANDALONE” has priority over UPS setting. Therefore above condition might occur.

When setting change is required, configure the menu item using “SANUPS SOFTWARE STANDALONE”.

Free Manuals Download Website

<http://myh66.com>

<http://usermanuals.us>

<http://www.somanuals.com>

<http://www.4manuals.cc>

<http://www.manual-lib.com>

<http://www.404manual.com>

<http://www.luxmanual.com>

<http://aubethermostatmanual.com>

Golf course search by state

<http://golfingnear.com>

Email search by domain

<http://emailbydomain.com>

Auto manuals search

<http://auto.somanuals.com>

TV manuals search

<http://tv.somanuals.com>