

Major Options

Optional Lenses

Lens Type	Short Fixed Lens	Short Zoom Lens	Short Zoom Lens	Standard Zoom Lens	Long Zoom Lens	Long Zoom Lens
Part Number	LNS-W52	LNS-W51	LNS-W50	LNS-S50	LNS-T50	LNS-T51
Image						
Zoom/ Focus	Fixed / motorised	x1.25 / motorised	x1.2 / motorised	x1.56 / motorised	x1.8 / motorised	x1.67 / motorised
Screen Size (")	50-200	50-600	50-600	50-600	50-600	50-600
Throw Ratio	0.8:1	1.2-1.5:1	1.5-1.8:1	1.8-2.8:1	2.8-5.0:1	4.8-8.0:1
F Value	2.0	2.3 - 2.7	2.0 - 2.1	2.0 - 2.6	2.0 - 2.9	2.3 - 3.2
Net Weight (Unit: kg (lb))	3.1 (6.8)	4.1 (9.0)	3.3 (7.3)	3.4 (7.5)	3.7 (8.2)	3.8 (8.4)
Lens H1:H2 (approx)	1:1	6.65:-1 - -1.6.65	6.65:-1 - -1.6.65	6.65:-1 - -1.6.65	6.65:-1 - -1.6.65	6.65:-1 - -1.6.65
Shift W1:W2 (approx)	1:1	10.7:1 - 1:10.7	10.7:1 - 1:10.7	10.7:1 - 1:10.7	10.7:1 - 1:10.7	10.7:1 - 1:10.7

Throw distance (Unit: m (ft))

Part Number	LNS-W52		LNS-W51		LNS-W50		LNS-S50		LNS-T50		LNS-T51	
	Fixed	Wide	Tele	Wide	Tele	Wide	Tele	Wide	Tele	Wide	Tele	
50"	0.86 (2.81)	1.3 (4.2)	1.6 (5.3)	1.6 (5.3)	2.0 (6.4)	1.9 (6.4)	3.1 (10.2)	3.0 (9.9)	5.6 (18.2)	5.4 (17.8)	8.9 (29.2)	
60"	1.04 (3.41)	1.5 (5.1)	2.0 (6.4)	1.9 (6.4)	2.4 (7.7)	2.4 (7.7)	3.7 (12.3)	3.7 (12.0)	6.7 (22.0)	6.5 (21.2)	10.7 (35.0)	
70"	1.22 (4.01)	1.8 (6.0)	2.3 (7.6)	2.3 (7.6)	2.8 (9.1)	2.8 (9.1)	4.4 (14.4)	4.3 (14.1)	7.8 (25.7)	7.5 (24.7)	12.4 (40.7)	
80"	1.41 (4.61)	2.1 (6.9)	2.7 (8.7)	2.6 (8.6)	3.2 (10.4)	3.2 (10.4)	5.0 (16.5)	4.9 (16.2)	9.0 (29.5)	8.6 (28.1)	14.2 (46.5)	
100"	1.77 (5.82)	2.7 (8.7)	3.3 (11.0)	3.3 (10.9)	4.0 (13.1)	4.0 (13.1)	6.3 (20.7)	6.2 (20.3)	11.3 (36.9)	10.7 (35.0)	17.7 (58.0)	
150"	2.69 (8.82)	4.0 (13.2)	5.1 (16.6)	5.0 (16.4)	6.0 (19.8)	6.0 (19.8)	9.5 (31.2)	9.4 (30.7)	17.0 (55.6)	15.9 (52.2)	26.5 (86.8)	
200"	3.60 (11.83)	5.4 (17.8)	6.8 (22.3)	6.7 (22.0)	8.1 (26.5)	8.1 (26.6)	12.7 (41.7)	12.5 (41.1)	22.7 (74.4)	21.2 (69.4)	35.3 (115.7)	
250"	-	6.8 (22.3)	8.5 (27.9)	8.4 (27.6)	10.1 (33.2)	10.1 (33.3)	15.9 (52.2)	15.7 (51.5)	28.4 (93.1)	26.4 (86.6)	44.0 (144.5)	
300"	-	8.2 (26.8)	10.2 (33.6)	10.1 (33.2)	12.2 (39.9)	12.2 (40.0)	19.1 (62.7)	18.9 (61.9)	34.1 (111.8)	31.7 (103.9)	52.8 (173.3)	

Option Board

DVI / D-sub module	POA-MD23ADI
5BNC / VIDEO module	POA-MD25VD3
DVI module	POA-MD18DVI
5BNC module	POA-MD16VD1
Network module	POA-MD13NET2(After Ver.4.404)
HD & SD-SDI module (SD-SDI not compatible)	POA-MD17SDID
HD DATA WIRELESS receiver board	POA-MD26HDWL
D-sub15 module	POA-MD04VGA

Terminals



Specifications

Model name	PDG-DHT100L
Panel	0.95" HD DLP® chip x 1
No. of pixels	2,073,600 (1920x1080 dots)
Projection lamp	VIDI™ UHP 330W x 2
Brightness (typical)*1	6,500 lm (with LNS-S50, "Dynamic" mode, DynamicBlack™ off)
Contrast *1	7,500:1 (with DynamicBlack™ High)
Uniformity *1	90 % (corner to center)
Image setting	Lens shift Vertical : 6.65:-1 - 1:6.65 Horizontal: 10.7:1 - 1:10.7 Digital Keystone :U/D/R/L
Optional lens	LNS-W52 / W51/W50/S50/T50/T51 (Throw ratio: 0.8, 1.2 - 8.0)
Color wheels	6 seg RGBCMY for rich color reproduction x 2 (provided as enclosed accessory) 4 seg RGBW for high brightness x 2
Other Features	<ul style="list-style-type: none"> Picture in Picture & Picture by Picture Mechanical lens shutter DynamicBlack™ (auto iris according to image) BrilliantColor™ VIDI™ lamp variable illumination Full 10bit circuit Auto picture control Color management
Signal Terminal	Input 1: RGB (D-Sub15), DVI-D (HDCP), HDMI (v1.3 with Deep Color) Input 2: RGBHV, Y, Pb/ Cb, Pr/ Cr, Video (BNC), S-Video Input 3: Detachable terminal for system up Input 4: Detachable terminal (NETWORK POA-MD13NET2) Output: RGB(D-sub15)---Analog input only
Control Port	RJ-45 wired LAN (POA-MD13NET2) D-sub9pin (RS232C) In/ Out Wired R/ C (Option: 98.4" long cable compatible)
Audio	None
Input signal	WUXGA/ UXGA/ WSXGA+/ SXGA+/ SXGA/ WXGA/ XGA/ SVGA/ VGA/ MAC, 1080p - 24/ 25/ 30/ 48/ 50/ 60, 1080psf - 24/ 25/ 30, 1080 i50/ 60, 720p - 50/ 60/ 57.5p/ 480p/ 57.5i/ 480i (depend on input)
Color systems	PAL/ SECAM/ NTSC/ NTSC4.43/ PALM/ N
Scanning frequency	H/V sync 15 - 120 kHz/ 48 - 120 Hz Dot clock 230 MHz
Fan Noise	36 dB (Eco1)
Voltage	100 - 120 V/ 200 - 240 V AC (auto voltage)
Dimensions (W x H x D)	400.0 x 242.5 x 523.5 mm (15.8 x 9.6 x 20.6")
Weight	19.8 kg (43.7 lb)
Power Consumption	PDG-DHT100L : 100 V : 846 W (Stand by : 28.5 W), 200 V : 794 W (Stand by : 27.8 W) PDG-DHT100WL : 100 V : 860 W (Stand by : 29.0 W), 200 V : 811 W (Stand by : 28.3 W)
Main Accessories	Rich color reproduction color wheel x 2 (High Brightness color wheel x 2 are installed in projector at shipping) Wireless (wired incl.) remote control x 1 (AA battery x 2) Cable cover 1-type (support cover x 1, cover x 1), Cable tie for fixed cable x 3 Removable power cord x 1, Fixing bracket for power cord x 1, Ferrite core (for LAN cable) x 1, Computer cable (D-sub type) x 1 Real Color Manager Pro (CD-ROM), Owners manual (CD-ROM) Lens hole cover x 1 PIN code-locking seal x 1

*1 Measurement, measuring conditions, and method of notation all comply with ISO 21118 international standards.
 * Replacement lamp type (610 343 5336)
 * "DLP" and "DynamicBlack" are registered trademarks of Texas Instruments.
 * All product names and company names are trademarks or registered trademarks of their respective

External dimensions (unit: mm (inch))

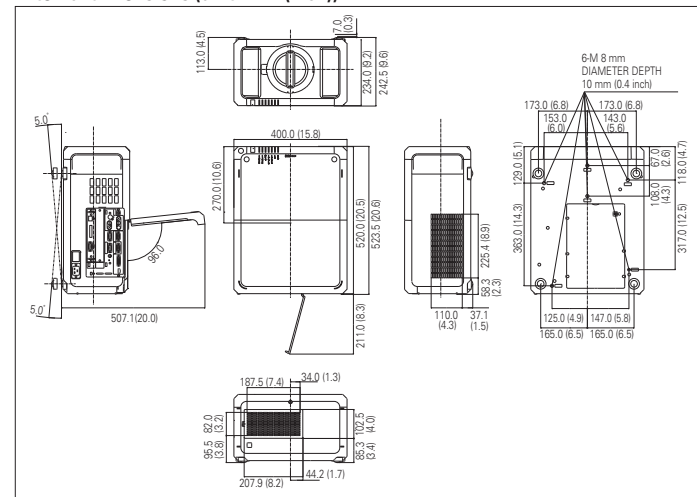

Caution: Please consult the instruction manual to ensure safe and proper operation of the product.

SANYO

SANYO Presentation Technologies

Toll free: 888-337-1215 www.sanyoprojectors.com

© 2009 Sanyo Presentation Technologies.

Think GAIA

For Life and the Earth

Multimedia Projector

Powerful Images for Large Venues and Digital Signage

The Industry's Brightest* Full HD Projectors



SANYO

PDG-DHT100L



*As of the scheduled release date at the end of March 2009, for 2 lamp, Full HD, 1 chip DLP® projector.

Advanced Technologies for Professional Use. Superb Image Expression with Flexible Installation and Easy Maintenance.

Higher Brightness and Superior Images

True Full HD Resolution

The PDG-DHT100L employs DMD panel (16:9 aspect ratio). With 1,920 x 1,080 pixels in the panel, the PDG-DHT100L can project native HDTV 1080p signals in full resolution.

DMD Panel helps convey the ambience in a scene with such exceptional fidelity. Full HD goes beyond conventional technology to reproduce images that are vibrantly alive and rich in emotion.

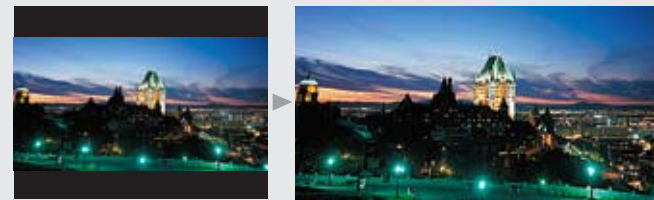

Industry's Brightest*1 6,500 lumens and Rich Color Reproduction

A twin color wheel system make it possible to achieve both high brightness and high color reproduction that is accurate in image signal. In addition, user can change color wheel according as application. The 4-segment color wheels team up with two high-output 330-watt lamps to achieve up to 6,500 lumens*1 of brightness in our 2-lamp, full-HD, 1-chip DLP® projector. Or you can choose the 6-segment color wheels for even richer, purer color reproduction.

*1 As of the time of sales at the end of March, 2009. for 2-lamp, full-HD, 1-chip DLP® projectors.

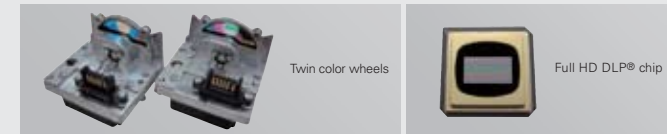
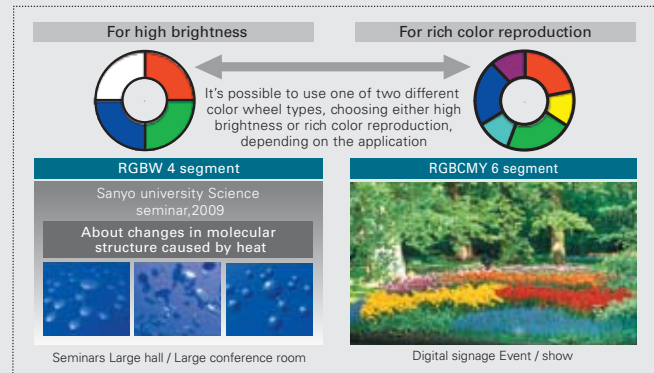

High Contrast 7500:1

This advanced optical system achieves high contrast*2 to project high-quality images with rich black reproduction, maximizing the quality of the video signals.

*2 with DynamicBlack™ High

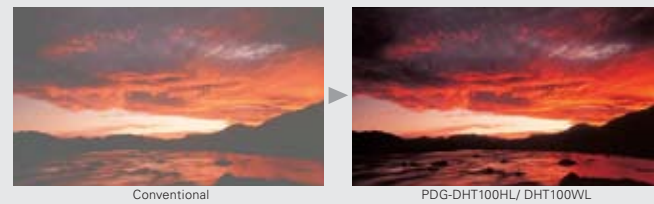

Network Control

HD*3 DATAWIRELESS

The Uncompressed HD*3 DATA WIRELESS Transmission System allows pure uncompressed data transmission without delays between the video and sound. Technology in wireless system allows uncompressed data even from distances of about 100 feet away from the input source. Easier set-up for place such as large event halls and other large rooms/theaters as it eliminates the need to feed cables and run wires from sources to projectors.

HD Wireless Transmission

System is sold as optional accessory for PDG-DHT100L.



*3 HD stands for high definition of 1080i or 720p *4 Actual Distance is dependent of a variety of environmental conditions

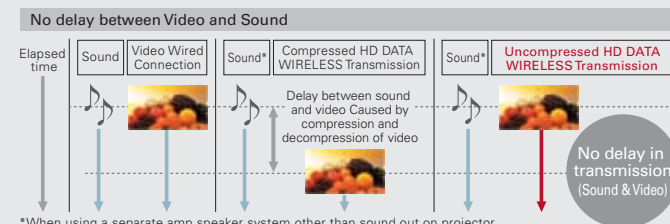

*When using a separate amp speaker system other than sound out on projector
*The above is an image used only for explanation purposes

Featuring the PJ-Net Organizer Board

The PJ-Net Organizer board is provided as standard equipment, for centralized control of projectors over a wired network. Installing the optional PJ Master into a PC or server also lets you control the PJ-Net Organizer-mounted projectors over a network.

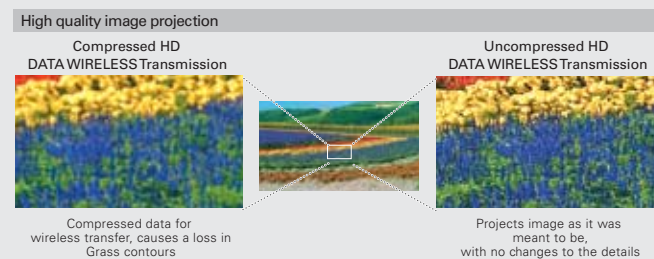

Transmit Up to 30 meters*2 Wirelessly

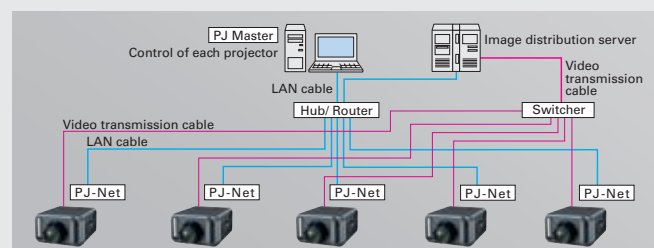
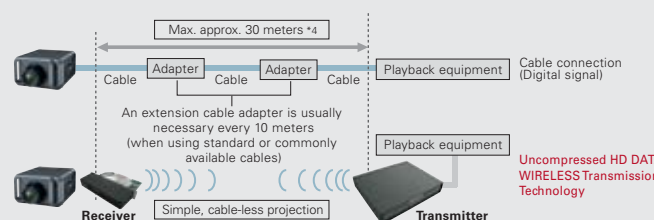

Easy Maintenance

The Industry's longest-lasting*5 35,000 hour-use filter 'Active Maintenance Filter', for cleaner and highly durable projection

Equipped with replaceable 'Active Maintenance Filter' for the Industry's longest lasting*5 35,000 hour-use automatic reel filter cartridge to prevent dust from entering the lamp area, while still allowing enough airflow to help the area to remain cool longer durability and reliability from the increased dust resistance and longer lasting filters.

*5 As of the time of sales at the end of March, 2009 (when in Eco1 mode, Based on JIS D-0207 accelerated testing environment conditions) *25,000 hour-use (when in Normal mode, Based on JIS D-0207 accelerated testing environment conditions)

Equipped with new, dust-resistant sealed optical engine

New, improved sealed optical engine cooling design to prevent dust build up, maintaining optimal brightness and contrast, problems that traditionally are difficult to overcome, causing reductions in projection quality Improved air control for more flexibility in using the projector in a variety of environments.

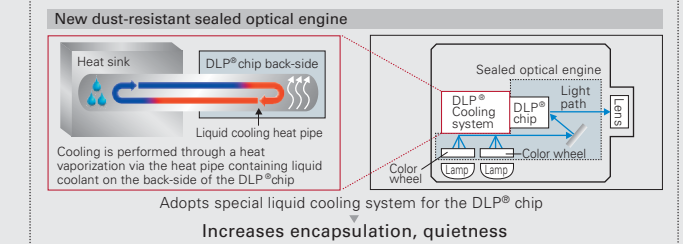
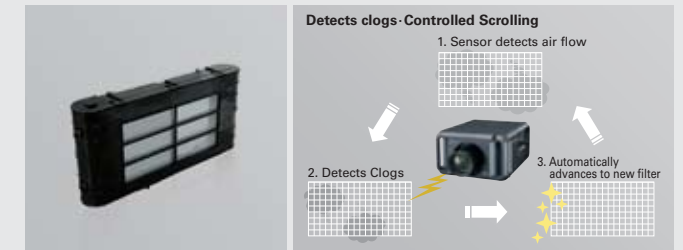

One-way Flow System

The PDG-DHT100L is concentrated into one intake and one exhaust, both on the side, to solve dust-related problems and improve cooling reliability.



Easier Replacement

Lamp and Twin Color Wheel replacement has been simplified to make maintenance easier. Easy removal and replacement of the lamp from the top.



Versatile Installation

Edge Blending & Color Matching

Equipped with "Edge Blending" function that allows what feels like boundary-less images with multi-image display possibilities Built-in "Color Matching" function correcting variations in color reproduction when using more than one projector.

'Edge Blending' function allows what feels like boundary-less images with multi-image display possibilities

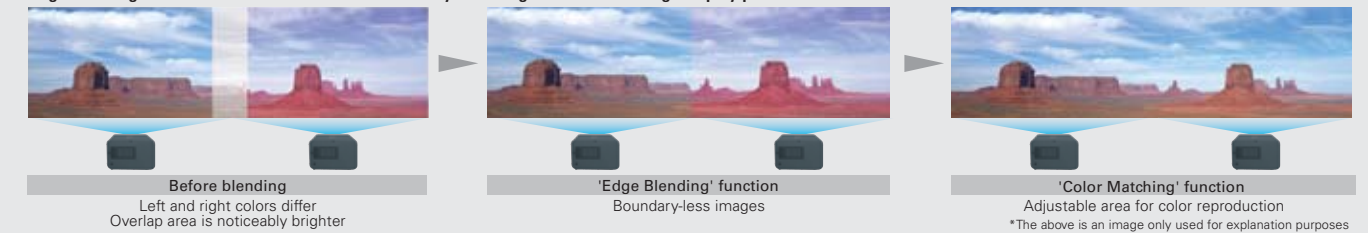

Power Lens Shift

Featuring both vertical and horizontal lens shift (vertical: 67 %, horizontal: 41 % (maximum), the PDG-DHT100L enables intuitive operation for easy on-site setup. The lens shifts back to the center by pressing a lens shift button for a little.

Interchangeable Lenses

Lens removal and attachment are also very easy.

Useful Features

There is also a Mechanical Shutter System which is popular for a variety of elite professional uses. The amazing PDG-DHT100L fills the needs of a host of demanding business venues including meeting, entertainment and promotional applications. It's a super nova in a star-studded selection of SANYO Portable projectors.

- "Lens center layout" symmetrical design
- Full light-up Control Panel & Remote Control

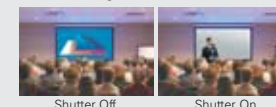

Vertical Tilt Angel Projection

Realizes vertical 360 degree tilt angle projection allowing projection positions from the ceiling or floor, breaking from traditional projection settings.

Picture-in-Picture mode and Picture-by-Picture mode

Capable of projecting two images simultaneously either using built-in picture-in-picture mode or picture-by-picture mode.

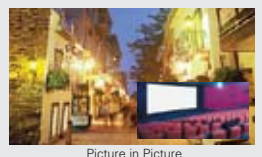

DLP 6,500 lm Full HD Projector
PDG-DHT100L

Free Manuals Download Website

<http://myh66.com>

<http://usermanuals.us>

<http://www.somanuals.com>

<http://www.4manuals.cc>

<http://www.manual-lib.com>

<http://www.404manual.com>

<http://www.luxmanual.com>

<http://aubethermostatmanual.com>

Golf course search by state

<http://golfingnear.com>

Email search by domain

<http://emailbydomain.com>

Auto manuals search

<http://auto.somanuals.com>

TV manuals search

<http://tv.somanuals.com>