

Multimedia Projector

MODEL PLC-EF12N/12NL
PLC-EF12E/12EL
PLC-EF12B/12BL

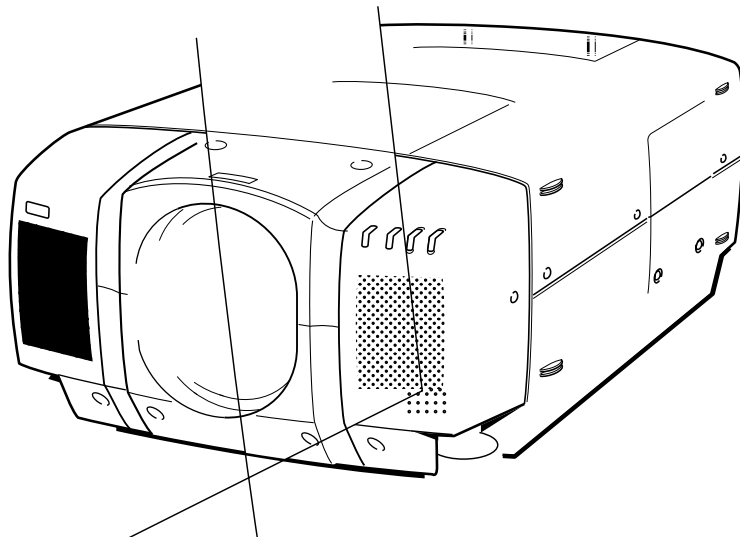

Owner's Manual

TO THE OWNER

Before operating this projector, read this manual thoroughly and operate the projector properly.

This projector provides many convenient features and functions. Operating the projector properly enables you to manage those features and maintains it in better condition for a considerable time.

Improper operation may result in not only shortening the product-life, but also malfunctions, fire hazard, or other accidents.

If your projector seems to operate improperly, read this manual again, check operations and cable connections and try the solutions in the "Trouble-shooting" section of the end of this booklet. If the problem still persists, contact the sales dealer where you purchased the projector or the service center.



SAFETY PRECAUTIONS

WARNING : TO REDUCE THE RISK OF FIRE OR ELECTRIC SHOCK, DO NOT EXPOSE THIS APPLIANCE TO RAIN OR MOISTURE.

- This projector produces intense light from the projection lens. Do not stare directly into the lens as possible. Eye damage could result. Be especially careful that children do not stare directly into the beam.
- This projector should be set in the way indicated. If not, it may result in a fire hazard.
- Take appropriate space on the top, sides and rear of the projector cabinet for allowing air circulation and cooling the projector. Minimum distance should be taken. If the projector is to be built into a compartment or similarly enclosed, the minimum distances must be maintained. Do not cover the ventilation slot on the projector. Heat build-up can reduce the service life of your projector, and can also be dangerous.
- Do not put any flammable object or spray can near the projector, hot air is exhausted from the ventilation holes.
- The Remote Control Unit, supplied to this projector, emits the laser beam as the Laser Pointer function from the Laser Light Window while pressing the LASER button. Do not look into the Laser Light Window or shine the laser beam on yourself or other people. Eye damage may result.
- If the projector is not to be used for an extended time, unplug the projector from the power outlet.

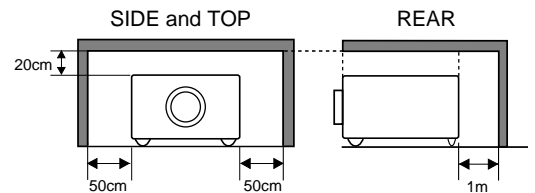

READ AND KEEP THIS OWNER'S MANUAL FOR LATER USE.



CAUTION
RISK OF ELECTRIC SHOCK
DO NOT OPEN



CAUTION : TO REDUCE THE RISK OF ELECTRIC SHOCK, DO NOT REMOVE COVER (OR BACK). NO USER-SERVICEABLE PARTS INSIDE EXCEPT LAMP REPLACEMENT. REFER SERVICING TO QUALIFIED SERVICE PERSONNEL.



THIS SYMBOL INDICATES THAT DANGEROUS VOLTAGE CONSTITUTING A RISK OF ELECTRIC SHOCK IS PRESENT WITHIN THIS UNIT.



THIS SYMBOL INDICATES THAT THERE ARE IMPORTANT OPERATING AND MAINTENANCE INSTRUCTIONS IN THE OWNER'S MANUAL WITH THIS UNIT.

SAFETY PRECAUTIONS

All the safety and operating instructions should be read before the product is operated.

Read all of the instructions given here and retain them for later use. Unplug this projector from AC power supply before cleaning. Do not use liquid or aerosol cleaners. Use a damp cloth for cleaning.

Follow all warnings and instructions marked on the projector.

For added protection to the projector during a lightning storm, or when it is left unattended and unused for long periods of time, unplug it from the wall outlet. This will prevent damage due to lightning and power line surges.

Do not expose this unit to rain or use near water... for example, in a wet basement, near a swimming pool, etc...

Do not use attachments not recommended by the manufacturer as they may cause hazards.

Do not place this projector on an unstable cart, stand, or table. The projector may fall, causing serious injury to a child or adult, and serious damage to the projector. Use only with a cart or stand recommended by the manufacturer, or sold with the projector. Wall or shelf mounting should follow the manufacturer's instructions, and should use a mounting kit approved by the manufacturers.

An appliance and cart combination should be moved with care. Quick stops, excessive force, and uneven surfaces may cause the appliance and cart combination to overturn.



Slots and openings in the back and bottom of the cabinet are provided for ventilation, to insure reliable operation of the equipment and to protect it from overheating.

The openings should never be covered with cloth or other materials, and the bottom opening should not be blocked by placing the projector on a bed, sofa, rug, or other similar surface. This projector should never be placed near or over a radiator or heat register.

This projector should not be placed in a built-in installation such as a book case unless proper ventilation is provided.

Never push objects of any kind into this projector through cabinet slots as they may touch dangerous voltage points or short out parts that could result in a fire or electric shock. Never spill liquid of any kind on the projector.

This projector should be operated only from the type of power source indicated on the marking label. If you are not sure of the type of power supplied, consult your authorized dealer or local power company.

Do not overload wall outlets and extension cords as this can result in fire or electric shock. Do not allow anything to rest on the power cord. Do not locate this projector where the cord may be damaged by persons walking on it.

Do not attempt to service this projector yourself as opening or removing covers may expose you to dangerous voltage or other hazards. Refer all servicing to qualified service personnel.

Unplug this projector from wall outlet and refer servicing to qualified service personnel under the following conditions:

- a. When the power cord or plug is damaged or frayed.
- b. If liquid has been spilled into the projector.
- c. If the projector has been exposed to rain or water.
- d. If the projector does not operate normally by following the operating instructions. Adjust only those controls that are covered by the operating instructions as improper adjustment of other controls may result in damage and will often require extensive work by a qualified technician to restore the projector to normal operation.
- e. If the projector has been dropped or the cabinet has been damaged.
- f. When the projector exhibits a distinct change in performance-this indicates a need for service.

When replacement parts are required, be sure the service technician has used replacement parts specified by the manufacturer that have the same characteristics as the original part. Unauthorized substitutions may result in fire, electric shock, or injury to persons.

Upon completion of any service or repairs to this projector, ask the service technician to perform routine safety checks to determine that the projector is in safe operating condition.

Voor de klanten in Nederland



Bij dit product zijn batterijen geleverd. Wanneer deze leeg zijn, moet u ze niet weggooien maar inleveren als KCA.

COMPLIANCES

Federal Communication Commission Notice

This equipment has been tested and found to comply with the limits for a Class A digital device, pursuant to Part 15 of FCC Rules. These limits are designed to provide reasonable protection against harmful interference when the equipment is operated in a commercial environment. This equipment generates, uses, and can radiate radio frequency energy and, if not installed and used in accordance with the instruction manual, may cause harmful interference to radio communications. Operation of this equipment in a residential area is likely to cause harmful interference in which case the user will be required to correct the interference at his own expense.

AC POWER CORD REQUIREMENT

The AC Power Cord supplied with this projector meets the requirement for use in the country you purchased it.

AC Power Cord for the United States and Canada :

AC Power Cord used in the United States and Canada is listed by the Underwriters Laboratories (UL) and certified by the Canadian Standard Association (CSA). AC Power Cord has a grounding-type AC line plug. This is a safety feature to be sure that the plug will fit into the power outlet. Do not try to defeat this safety feature. Should you be unable to insert the plug into the outlet, contact your electrician.

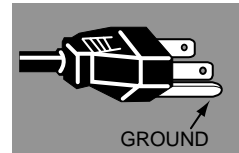

AC Power Cord for the United Kingdom :

This cord is already fitted with a moulded plug incorporating a fuse, the value of which is indicated on the pin face of the plug. Should the fuse need to be replaced, an ASTA approved BS 1362 fuse must be used of the same rating, marked thus \diamond . If the fuse cover is detachable, never use the plug with the cover omitted. If a replacement fuse cover is required, ensure it is of the same colour as that visible on the pin face of the plug (i.e. red or orange). Fuse covers are available from the Parts Department indicated in your User Instructions. If the plug supplied is not suitable for your socket outlet, it should be cut off and destroyed. The end of the flexible cord should be suitably prepared and the correct plug fitted. (See Over)

WARNING : A PLUG WITH BARED FLEXIBLE CORD IS HAZARDOUS IF ENGAGED IN A LIVE SOCKET OUTLET.

The Wires in this mains lead are coloured in accordance with the following code:

Green-and-yellow Earth
Blue Neutral
Brown Live

As the colours of the wires in the mains lead of this apparatus may not correspond with the coloured markings identifying the terminals in your plug proceed as follows:

The wire which is coloured green-and-yellow must be connected to the terminal in the plug which is marked by the letter E or by the safety earth symbol \perp or coloured green or green-and-yellow.

The wire which is coloured blue must be connected to the terminal which is marked with the letter N or coloured black.

The wire which is coloured brown must be connected to the terminal which is marked with the letter L or coloured red.

WARNING : THIS APPARATUS MUST BE EARTHED.

THE SOCKET-OUTLET SHOULD BE INSTALLED NEAR THE EQUIPMENT AND EASILY ACCESSIBLE.

TABLE OF CONTENTS

| | | | |
|------------------------------------|-----------|------------------------------------|-----------|
| FEATURES AND DESIGN | 6 | COMPUTER MODE | 36 |
| PREPARATION | 7 | SELECTING COMPUTER MODE | 36 |
| NAME OF EACH PART OF THE PROJECTOR | 7 | SELECTING COMPUTER SYSTEM | 36 |
| SETTING-UP THE PROJECTOR | 8 | COMPATIBLE COMPUTER SPECIFICATIONS | 37 |
| CONNECTING THE AC POWER CORD | 8 | PC ADJUSTMENT | 38 |
| POSITIONING THE PROJECTOR | 9 | PICTURE IMAGE ADJUSTMENT | 40 |
| PICTURE LEVEL AND TILT ADJUSTMENT | 10 | NORMAL FUNCTION | 41 |
| MOVING THE PROJECTOR | 10 | AUTO IMAGE ADJUSTMENT | 41 |
| | | PICTURE POSITION ADJUSTMENT | 42 |
| | | PICTURE SCREEN ADJUSTMENT | 43 |
| CONNECTING THE PROJECTOR | 11 | VIDEO MODE | 44 |
| TERMINAL OF THE PROJECTOR | 11 | SELECTING VIDEO MODE | 44 |
| CONNECTING THE COMPUTER | 13 | SELECTING VIDEO SOURCE | 44 |
| CONNECTING THE VIDEO EQUIPMENT | 21 | SELECTING COLOR SYSTEM | 45 |
| | | PICTURE IMAGE ADJUSTMENT | 46 |
| | | NORMAL FUNCTION | 47 |
| | | PICTURE SCREEN ADJUSTMENT | 47 |
| BEFORE OPERATION | 23 | SETTING | 48 |
| CONTROLS AND INDICATORS | 23 | SETTING MENU | 48 |
| OPERATION OF THE REMOTE CONTROL | 25 | SETTING LANGUAGE | 49 |
| WIRELESS REMOTE CONTROL UNIT | 25 | | |
| WIRELESS/WIRED REMOTE CONTROL UNIT | 28 | | |
| OPERATING ON-SCREEN MENU | 30 | APPENDIX | 50 |
| HOW TO OPERATE ON-SCREEN MENU | 30 | OPERATING WIRELESS MOUSE | 50 |
| FLOW OF ON-SCREEN MENU | 30 | MAINTENANCE | 51 |
| MENU BAR | 31 | TEMPERATURE WARNING INDICATOR | 51 |
| | | AIR FILTER CARE AND CLEANING | 51 |
| | | LAMP REPLACEMENT | 52 |
| | | CLEANING THE PROJECTION LENS | 53 |
| | | TROUBLESHOOTING | 53 |
| | | TECHNICAL SPECIFICATIONS | 55 |
| BASIC OPERATION | 32 | | |
| TURNING ON / OFF THE PROJECTOR | 32 | | |
| TO TURN ON THE PROJECTOR | 32 | | |
| TO TURN OFF THE PROJECTOR | 32 | | |
| ADJUSTING THE IMAGE | 33 | | |
| ZOOM ADJUSTMENT | 33 | | |
| FOCUS ADJUSTMENT | 33 | | |
| LENS SHIFT FUNCTION | 33 | | |
| DIGITAL ZOOM FUNCTION | 33 | | |
| NORMAL PICTURE FUNCTION | 33 | | |
| FREEZE PICTURE FUNCTION | 34 | | |
| NO SHOW FUNCTION | 34 | | |
| P-TIMER FUNCTION | 34 | | |
| AUTO IMAGE ADJUSTMENT | 34 | | |
| CURSOR FUNCTION | 34 | | |
| SOUND ADJUSTMENT | 35 | | |
| DIRECT OPERATION | 35 | | |
| MENU OPERATION | 35 | | |

TRADEMARKS

- Apple, Macintosh, and PowerBook are trademarks or registered trademarks of Apple Computer, Inc.
- IBM and PS/2 are trademarks or registered trademarks of International Business Machines, Inc.
- Windows and PowerPoint are registered trademarks of Microsoft Corporation.
- Each name of corporations or products in the owner's manual is a trademark or a registered trademark of its respective corporation.

FEATURES AND DESIGN

This Multimedia Projector is designed with the most advanced technology for portability, durability, and ease of use. The projector utilizes built-in multimedia features, a palette of 16.77 million colors, and matrix liquid crystal display (LCD) technology.

◆ Compatibility

This projector widely accepts various video and computer input signals including;

- **Computers**
IBM-compatible and Macintosh computers up to 1600 x 1200 resolution.
- **6 Color Systems**
NTSC, PAL, SECAM, NTSC 4.43, PAL-M or PAL-N color system can be connected.
- **S-Video**
S-Video signals, such as a S-VHS VCR output signals, can be connected.

◆ High Resolution Image

This projector provides 1280 x 1024 dots resolution for computer input and 800 horizontal TV lines. The resolution from the computer between 1280 x 1024 and 1600 x 1200 is compressed into 1280 x 1024 dots. This projector cannot display image of over 1600 x 1200 dots. When the resolution of your computer is over than 1600 x 1200, reset the computer output for lower resolution.

◆ Multi-Scan System

This projector has Multi-Scan System to conform to almost all computer output signals quickly. There is no need for troublesome manual adjustment of frequency and other settings.

◆ One-Touch Auto Imaging

Incoming computer video signals are recognized and the best setting is automatically selected by the Auto Image adjustment. No complicated setup is necessary and projection is always precise.

◆ Multilanguage Menu Display

Operation menu is displayed in; English, Deutsch, Français, Italiano, Español, or Japanese.

◆ Digital Zoom (Computer Mode only)

The Digital Zoom magnifies the image up to 16 times, allowing you to focus on crucial information at a presentation.

◆ Motor-driven Lens Shift

The projection lens can be moved up and down with the motor-driven lens shift function. This function makes it easy to provide the projected image where you want. The zoom and focus can be also adjusted with motor-driven operation.

◆ Power Management

Power Management function is provided to reduce power consumption while the projector is not in use.

This Power Management function operates to turn the Projection Lamp off when the projector detects signal interruption and any button is not pressed over 5 minutes. The Projection Lamp is automatically turned on again when the projector detects the signal or any operation button is pressed.

This projector is shipped with this function ON.

◆ Laser Pointer Function

The Wireless Remote Control Unit supplied with this projector includes the Laser Pointer function. This function helps you to make a smart presentation on a projected screen.

◆ Wireless Mouse

The Wireless Remote Control Unit supplied with this projector has Wireless Mouse function for the connected computer. This function enables you to operate both projector and computer with this Wireless Remote Control Unit only.

◆ Accessories

The projector comes with the parts listed below. Check to find all the parts are included. If any parts are missing, contact an authorized dealer or service station.

- Owner's Manual.
- AC Power Cord.
- Wireless Remote Control Unit.
- Wireless/Wired Remote Control Unit.
- Remote Control Cable.
- Batteries for Remote Control Units.
- Graphic Accelerator Board and its Software.
- Digital Flat Panel Cable.
- VGA Cable.
- Mouse Cable for PS/2 port.
- Mouse Cable for serial port.
- Mouse Cable for ADB port.
- VGA/MAC Adapter.
- Protective Dust Cover
- Lens Cover.

PREPARATION

NAME OF EACH PART OF THE PROJECTOR

FRONT OF THE PROJECTOR

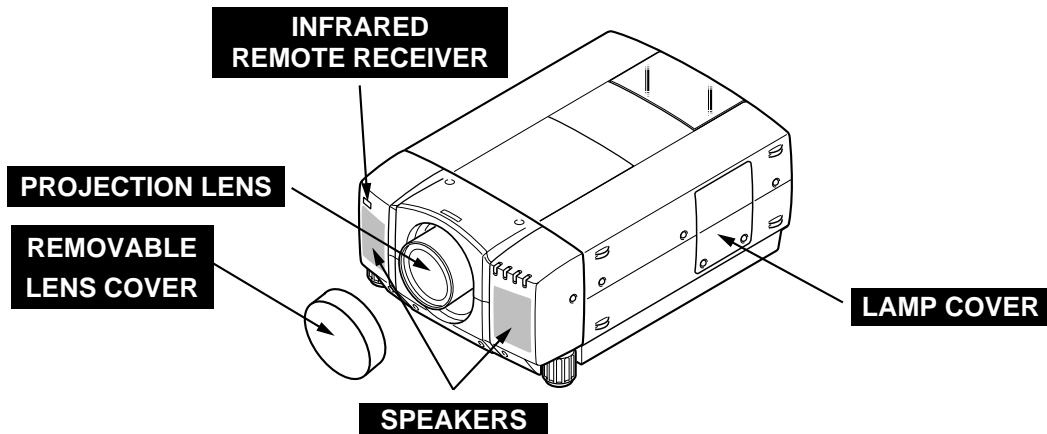

REAR OF THE PROJECTOR

EXHAUST VENT



HOT AIR EXHAUSTED !

Air blown from the exhaust vent is hot. Observe the following when handling your projector or choosing a location to install it.

- Keep heat-sensitive objects away from the exhaust port.
- If you set the projector on top of a metallic surface, the surface will become hot because of the hot air exhaust. Be careful when handling.
- Do not touch the cabinet near to the exhaust vent area, and especially screws and metallic parts. These parts will become hot while the projector is used.

This projector detects the internal temperature and automatically controls the operating power of the Cooling Fans.

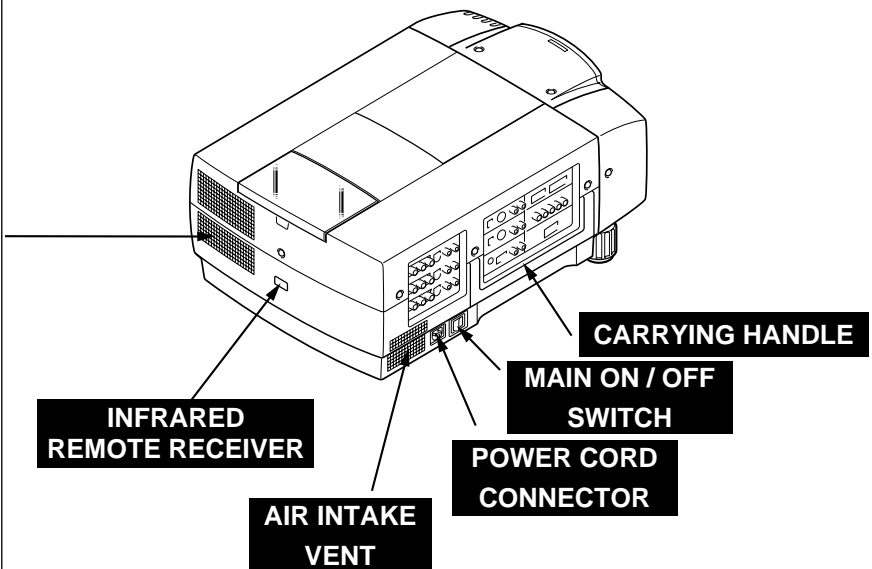

BOTTOM OF THE PROJECTOR

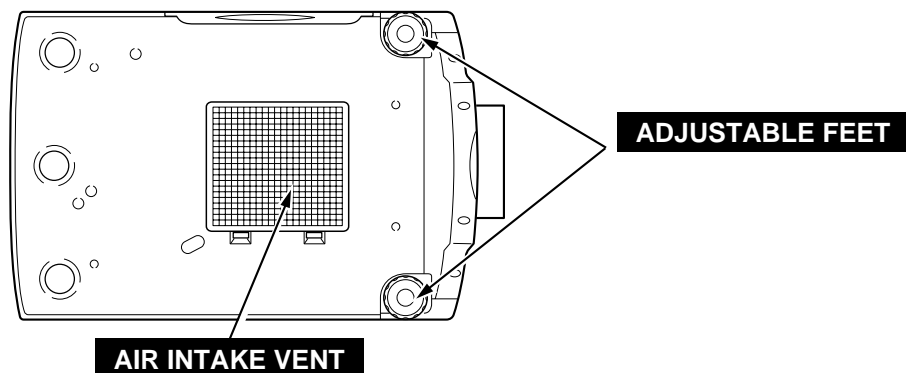

SETTING-UP THE PROJECTOR

CONNECTING THE AC POWER CORD

This projector uses nominal input voltages of 100-120 V or 200-240 V AC. The projector automatically selects the correct input voltage. It is designed to work with single-phase power systems having a grounded neutral conductor. To reduce the risk of electrical shock, do not plug into any other type of power system. Consult your authorized dealer or service station if you are not sure of the type of power supply being in use. Connect the projector with the peripheral equipment before turning the projector on. (Refer to pages 13 ~ 22 for connection.)

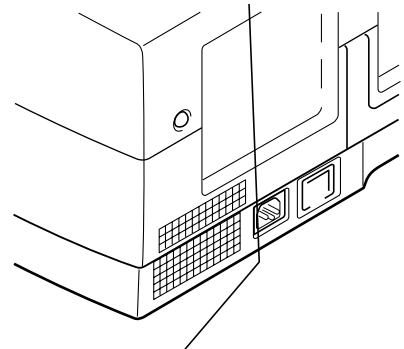

Connect the AC Power Cord (supplied) to the projector. The AC outlet must be near this equipment and must be easily accessible.

NOTE ON THE POWER CORD

The AC Power Cord must meet the requirement of the country where you use the projector. Confirm the AC plug type with the chart below and the proper AC power cord must be used. If the supplied AC Power Cord does not match the AC outlet, contact your sales dealer.

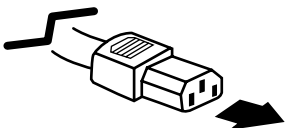
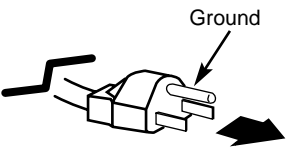
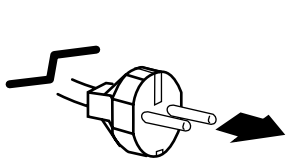
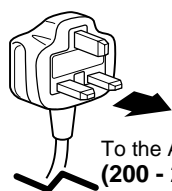
| Projector side | AC Outlet side | | |
|--|---|---|--|
|  <p data-bbox="235 1312 454 1396">To the POWER CORD CONNECTOR on the projector.</p> | <p data-bbox="487 1123 795 1155">For the U.S.A. and Canada</p>  <p data-bbox="617 1323 787 1375">To the AC Outlet. (120 V AC)</p> | <p data-bbox="820 1123 1128 1155">For Continental Europe</p>  <p data-bbox="941 1344 1128 1396">To the AC Outlet. (200 - 240 V AC)</p> | <p data-bbox="1226 1123 1380 1155">For the U.K.</p>  <p data-bbox="1274 1312 1453 1375">To the AC Outlet. (200 - 240 V AC)</p> |

POSITIONING THE PROJECTOR

- This projector is basically designed to project on a flat projection surface.
- This projector can be focused from 4.9' (1.5 m) ~ 80.7' (24.6 m).
- Refer to the figure below as an example when positioning the projector to the screen.



THIS PROJECTOR SHOULD BE SET IN THE WAY INDICATED. NEVER HANG THE PROJECTOR, OR FALL DOWN ON ITS SIDE. IT MAY RESULT IN FIRE HAZARD.

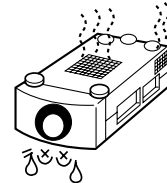

ROOM LIGHT

The projector should be placed in a room with limited light. Picture quality will be directly affected by lightning conditions.

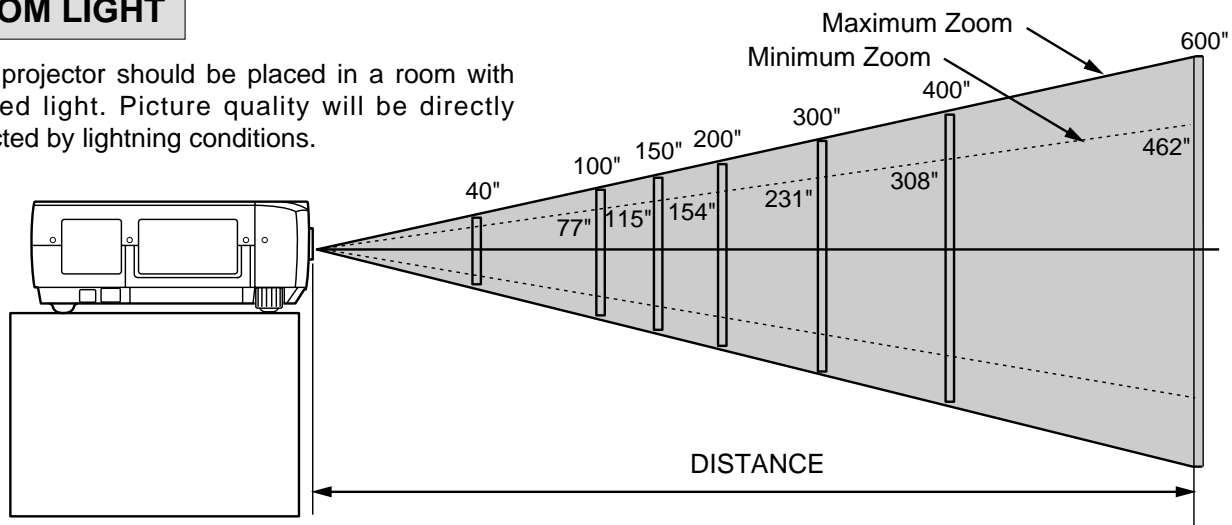

| | | | | | | | | |
|-------------|-----------|--------------|---------------|-------------|---------------|--------------|----------------|----------------|
| Screen Size | Max. Zoom | 40" | 100" | 150" | 200" | 300" | 400" | 600" |
| | Min. Zoom | ----- | 77" | 115" | 154" | 231" | 308" | 462" |
| Distance | | 4.9' (1.5 m) | 13.1' (4.0 m) | 20' (6.1 m) | 26.9' (8.2 m) | 40' (12.2 m) | 53.8' (16.4 m) | 80.7' (24.6 m) |

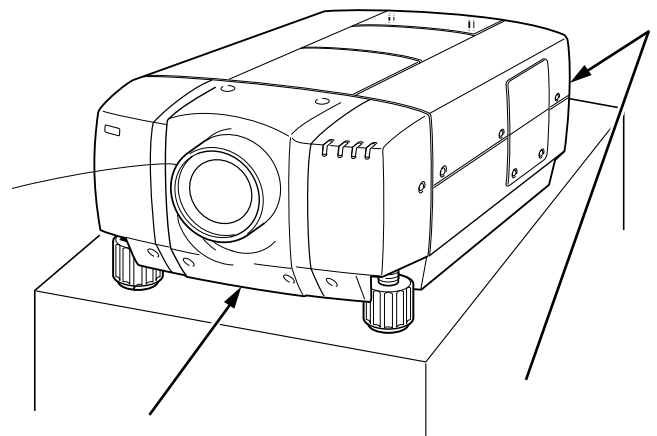

Use the carry handle when moving the projector.
Replace the lens cover and rotate the adjustable feet fully clockwise.

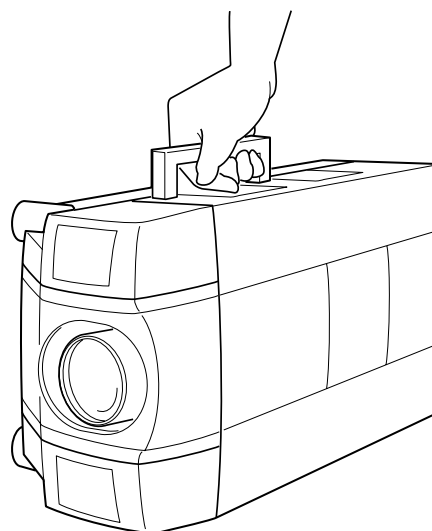

CAUTION IN CARRYING OR TRANSPORTING THE PROJECTOR

- Do not drop or bump the projector, otherwise damages or malfunctions may result.
- When carrying the projector, use a suitable carrying case.
- Do not transport the projector by using a courier or transport service in an unsuitable transport case. This may cause damage to the projector. To transport the projector through a courier or transport service, consult your dealer and best case should be applied.

CONNECTING THE PROJECTOR

TERMINAL OF THE PROJECTOR

SIDE OF THE PROJECTOR (CONNECT THE COMPUTER)

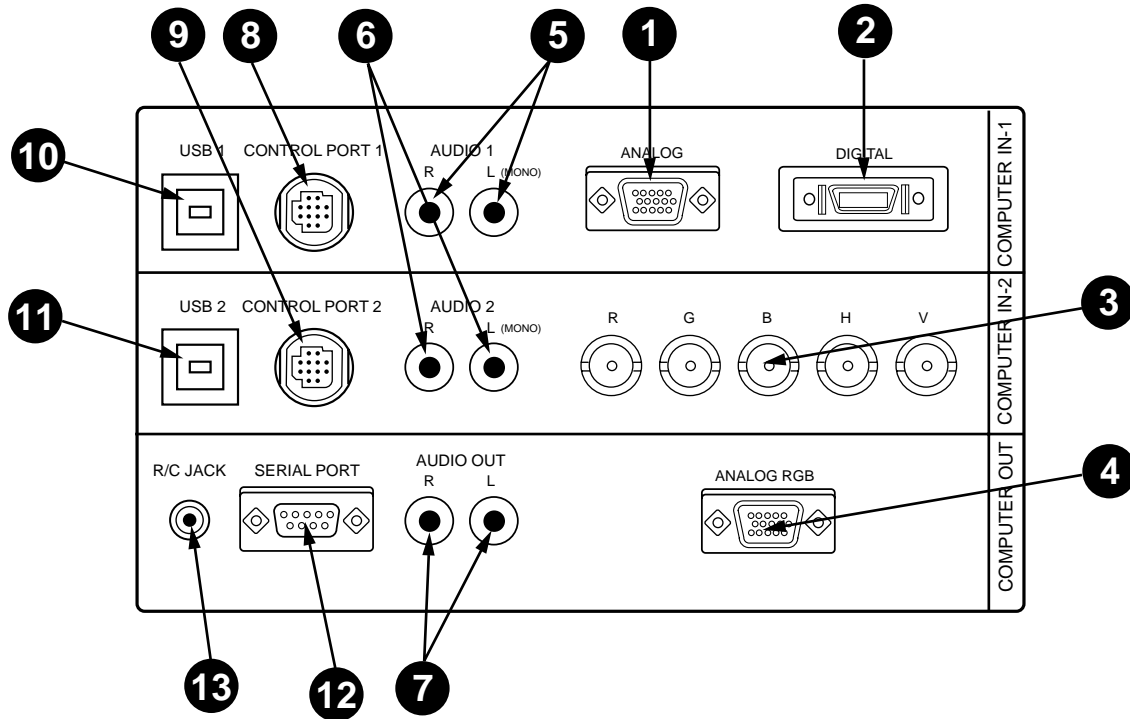

- 1 COMPUTER INPUT-1 TERMINAL (ANALOG HDB 15-PIN)**
Used to connect a computer to the projector.
- 2 COMPUTER INPUT-1 TERMINAL (DIGITAL MDR 20-PIN)**
Used to connect a computer to the projector.
- 3 COMPUTER INPUT-2 JACKS (BNC TYPE x 5)**
Used to connect a computer to the projector.
- 4 MONITOR OUTPUT TERMINAL (ANALOG HDB 15-PIN)**
Used to connect a monitor to the projector.
- 5 COMPUTER AUDIO INPUT-1 JACKS (R and L)**
Used to connect an audio output from the computer to the projector.
- 6 COMPUTER AUDIO INPUT-2 JACKS (R and L)**
Used to connect an audio output from the computer to the projector.
- 7 AUDIO MONITOR OUTPUT JACKS (R and L)**
Used to connect an audio input from audio equipment to the projector.
- 8 CONTROL PORT-1 CONNECTOR**
Used to connect a mouse cable to the projector.
- 9 CONTROL PORT-2 CONNECTOR**
Used to connect a mouse cable to the projector.
- 10 USB PORT-1 CONNECTOR**
Used to connect a computer to the projector.
- 11 USB PORT-2 CONNECTOR**
Used to connect a computer to the projector.
- 12 SERIAL PORT TERMINAL (DB9)**
Used to connect a computer to the projector.
- 13 WIRED REMOTE JACK**
When using the wired remote control, connect the remote cable to this jack.

CONNECTING THE PROJECTOR

SIDE OF THE PROJECTOR (CONNECT THE VIDEO EQUIPMENT)

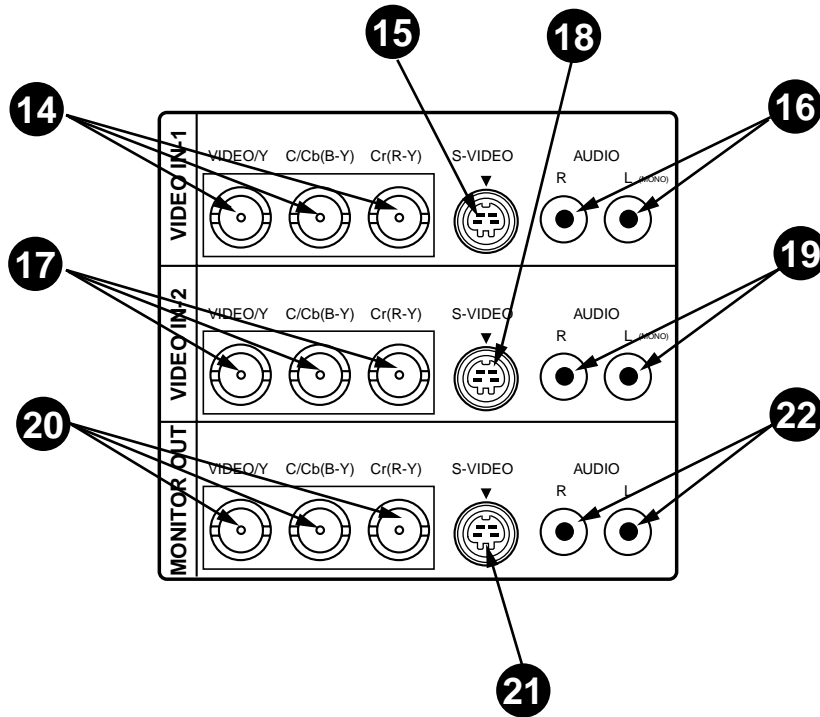

- 14 VIDEO INPUT JACKS-1 (BNC TYPE x 3)**
Used to connect a video source to the projector.
- 15 S-VIDEO INPUT JACK-1**
Used to connect a S-VHS video source to the projector.
- 16 AUDIO INPUT JACKS-1 (R and L)**
Used to connect an audio source to the projector.
- 17 VIDEO INPUT JACKS-2 (BNC TYPE x 3)**
Used to connect a video source to the projector.
- 18 S-VIDEO INPUT JACK-2**
Used to connect a S-VHS video source to the projector.
- 19 AUDIO INPUT JACKS-2 (R and L)**
Used to connect an audio source to the projector.
- 20 VIDEO MONITOR OUTPUT JACKS (BNC TYPE x 3)**
Permits video connection to a monitor.
- 21 VIDEO MONITOR (S-VIDEO) OUTPUT JACK**
Permits S-VHS video connection to a monitor.
- 22 AUDIO MONITOR OUTPUT JACKS (R and L)**
Permits audio connection to a monitor.

CONNECTING THE COMPUTER

CONNECTING TO THE COMPUTER INPUT 1 TERMINAL (ANALOG HDB 15-PIN)

Personal computers can be connected to the HDB15-pin (VGA) terminal on the projector.

- Connect the computer to these terminals using the VGA cable and VGA/MAC adapter (provided).

CAUTION: For projectors, the VGA cable provided is designed to reduce RFI (Radio Frequency Interference) emissions. For regulatory compliance reasons, this cable must be used and must not be replaced by any other cable.

CONNECTING TO THE COMPUTER INPUT 1 TERMINAL (DIGITAL MDR 20-PIN)

Digital output signal from the computer can be connected to the DIGITAL terminal (MDR 20-pin). When using this input, Graphic Accelerator Board designed for this projector should be installed into your computer and set-up the computer configuration following instruction included in the Graphic Accelerator Board package. Refer to DIGITAL INPUT CONNECTION on page 16 and 18.

CONNECTING TO THE COMPUTER INPUT 2 JACKS (BNC x 5)

Personal computers can be connected to the computer input (Red, Green, Blue, Horiz. Sync. and Vert. Sync.) on the projector.

- Connect the computer to these jacks using the BNC cables (not provided).

CONNECTING TO THE COMPUTER AUDIO INPUT JACKS (1 and 2)

- Connect audio outputs from your computer to these jacks using the audio cable (not provided).

CONNECTING TO THE MULTI-POLE 12-PIN (CONTROL PORT) CONNECTORS (1 and 2)

- When the computer is operated by projector's remote control unit, connect three different type of cables (provided) between projector control port and computer mouse port or serial port.

| COMPUTER TYPE | CABLE |
|---|------------------------------|
| IBM Compatible computer with PS/2 mouse port. | Mouse Cable for PS/2 port. |
| IBM Compatible computer with serial port. | Mouse Cable for Serial port. |
| Apple Macintosh computer with ADB mouse port. | Mouse Cable for ADB port. |

■ CONTROL PORT

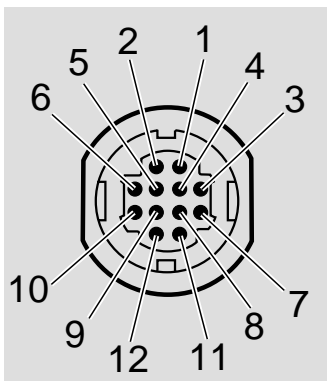

| | PS/2 Port | Serial Port | ADB Port |
|----|-----------|-------------|----------|
| 1 | _____ | T x D | _____ |
| 2 | CLK | _____ | ADB |
| 3 | DATA | _____ | _____ |
| 4 | _____ | _____ | _____ |
| 5 | _____ | _____ | _____ |
| 6 | _____ | _____ | _____ |
| 7 | _____ | READY | _____ |
| 8 | _____ | _____ | _____ |
| 9 | GND | GND | GND |
| 10 | _____ | _____ | _____ |
| 11 | _____ | _____ | _____ |
| 12 | _____ | _____ | _____ |

CONTROL PORT CABLE REMOVAL HINT

Disconnect control port cable with following steps.

1. Hold the portion (A) of the connector with one hand.
2. Pull the portion (B) arrow direction and remove connector.

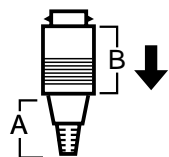

CONNECTING THE PROJECTOR

CONNECTING TO THE MONITOR OUTPUT TERMINAL (ANALOG HDB 15-PIN)

This terminal outputs the information of the selected computer source being viewed on the screen (Computer 1 or Computer 2). When video source ("Video 1" or "Video 2") is selected, this terminal outputs Computer 1 input information.

An external monitor can be connected to the HDB15-pin (VGA) terminal on the projector.

- Connect the monitor to this terminal using the VGA cable (not provided).

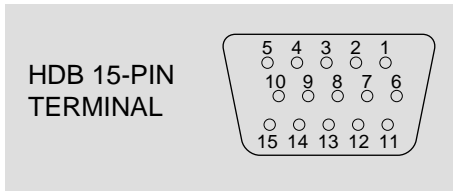

Pin No./Signal

- 1 Red input
- 2 Green input
- 3 Blue input
- 4 Sense 2
- 5 Ground (Horiz.sync.)
- 6 Ground (Red)
- 7 Ground (Green)
- 8 Ground (Blue)

Pin No./Signal

- 9 Non Connect
- 10 Ground (Vert. sync.)
- 11 Sense 0
- 12 Sense 1
- 13 Horiz. sync
- 14 Vert. sync
- 15 Reserved

CONNECTING TO THE AUDIO MONITOR OUTPUT (VARIABLE) JACKS

These jacks will contain the audio information of the selected program source being viewed on the screen (Computer 1, Computer 2, Video 1 or Video 2). If you have selected program source Computer 2 the audio signal connected to the Computer 2 audio input jack will be available at the audio monitor output jacks.

Use RCA type audio for connection.

- If the audio input of the audio equipment is stereo, be sure to connect the right and left channels to the respective right and left jacks.
- If the audio input of the audio equipment is monaural, connect it to the left jack.

CONNECTING TO THE SERIAL PORT (DB 9-PIN) TERMINAL

- If you control the projector by computer, you must connect a cable (not provided) from your computer to this terminal.

■ SERIAL PORT

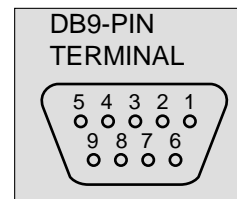

| | |
|---|--------|
| 1 | ————— |
| 2 | R x D |
| 3 | T x D |
| 4 | ————— |
| 5 | Ground |
| 6 | ————— |
| 7 | ————— |
| 8 | ————— |
| 9 | ————— |

CONNECTING TO THE USB PORT CONNECTORS (1 and 2)

This port is used to control the projector with the computer. It is also used to control the computer with the Remote control of this projector. (Refer to P49, 50.)

Connect the USB port of the computer to this port.

■ USB PORT

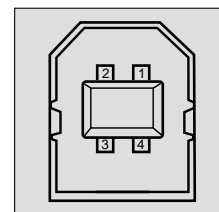

| | |
|---|--------|
| 1 | Vcc |
| 2 | - Data |
| 3 | + Data |
| 4 | Ground |

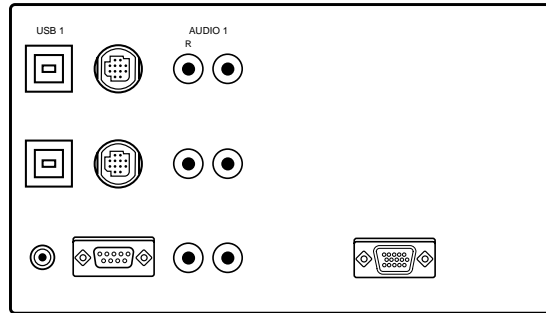

CONNECTING AN IBM-COMPATIBLE DESKTOP COMPUTER (DIGITAL INPUT CONNECTION)

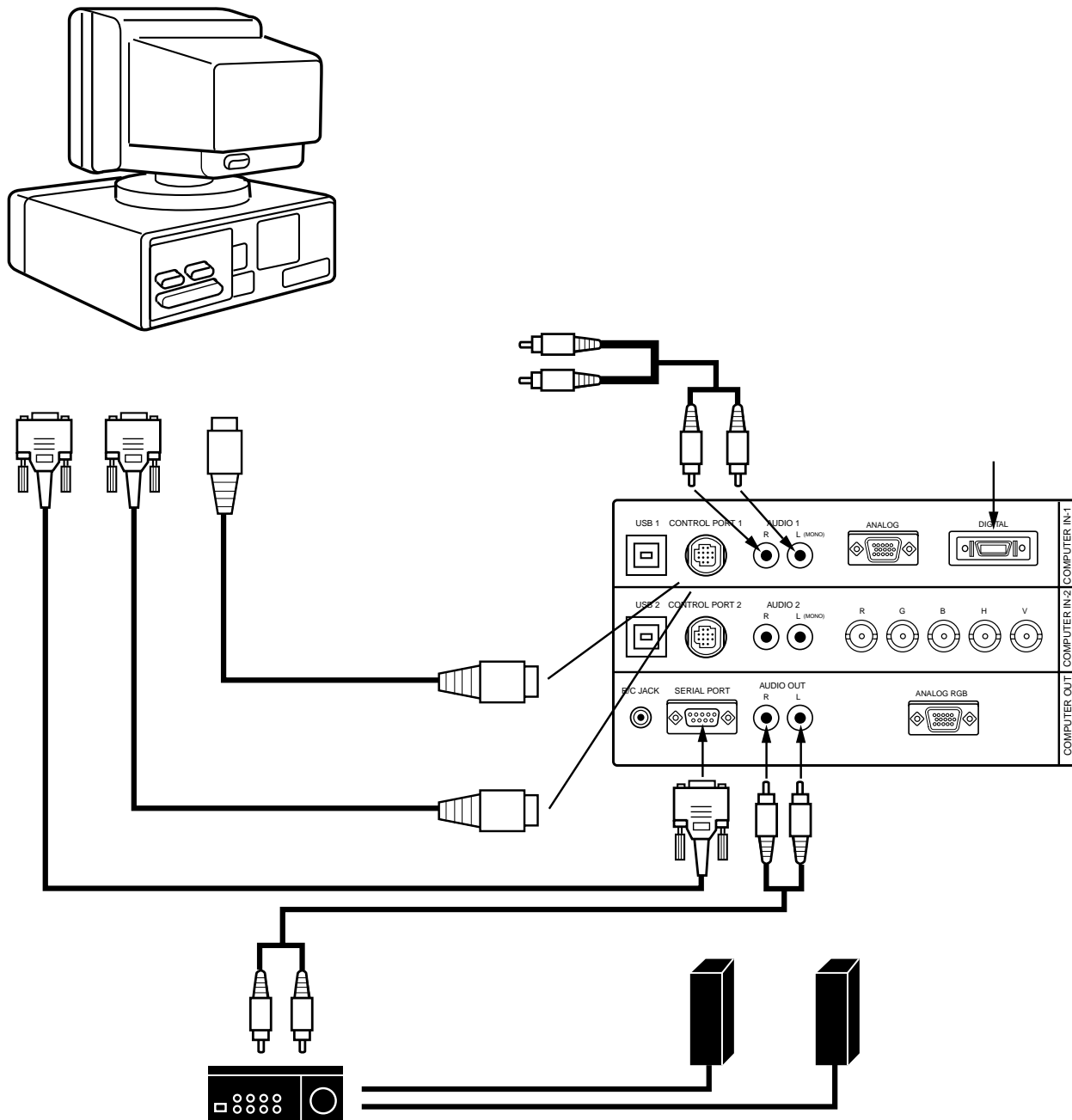

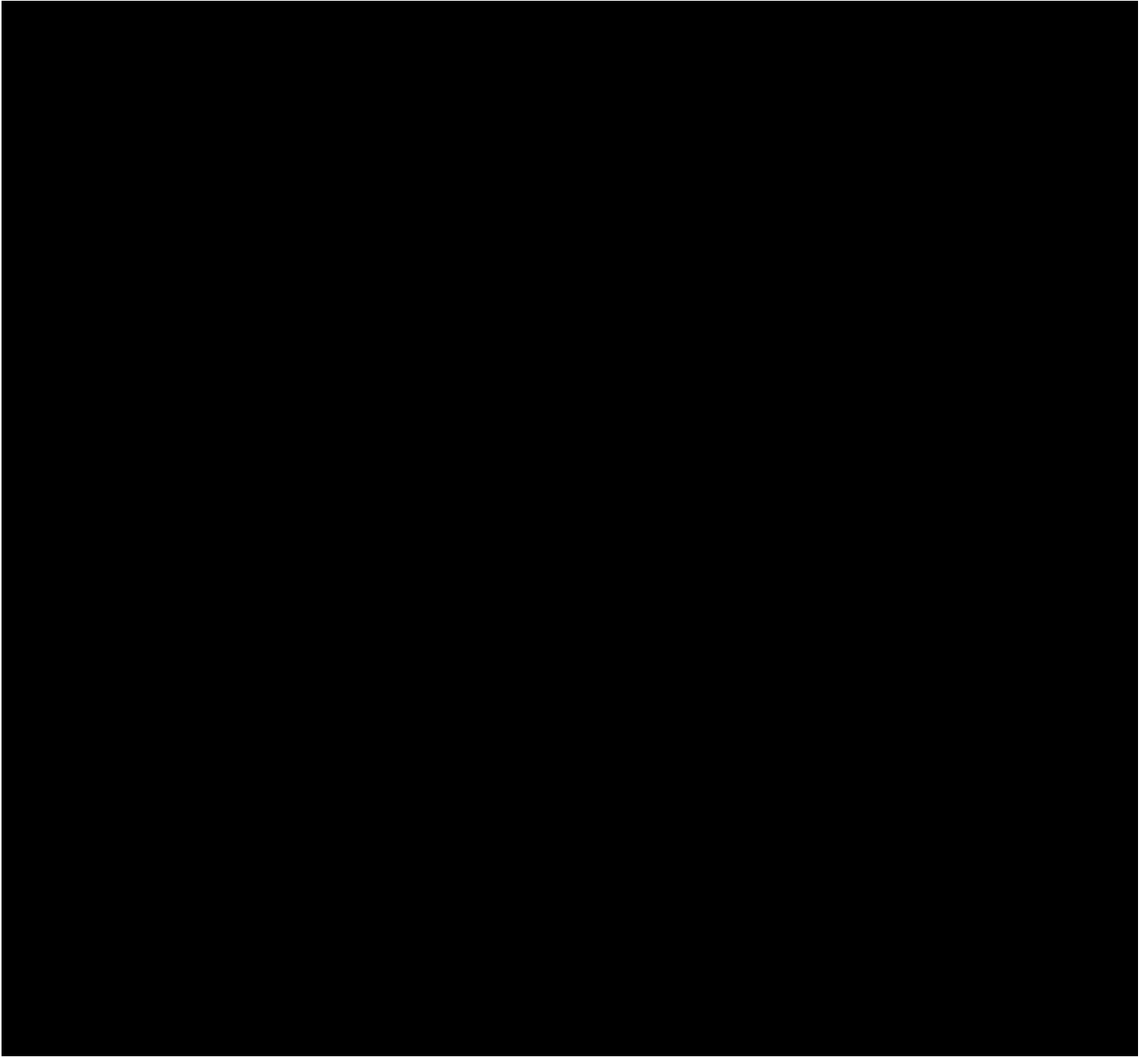

CONNECTING THE PROJECTOR

CONNECTING AN IBM-COMPATIBLE LAPTOP COMPUTER (DIGITAL INPUT CONNECTION)

NOTE: This connection need optionally sold Graphic Accelerator PC card.
For this information, contact to your authorized dealer.

Before using with digital connection, install (Plug in) Graphic Accelerator PC card into card bus slot of the computer and set up the computer following instructions in the Graphic Accelerator PC card package.

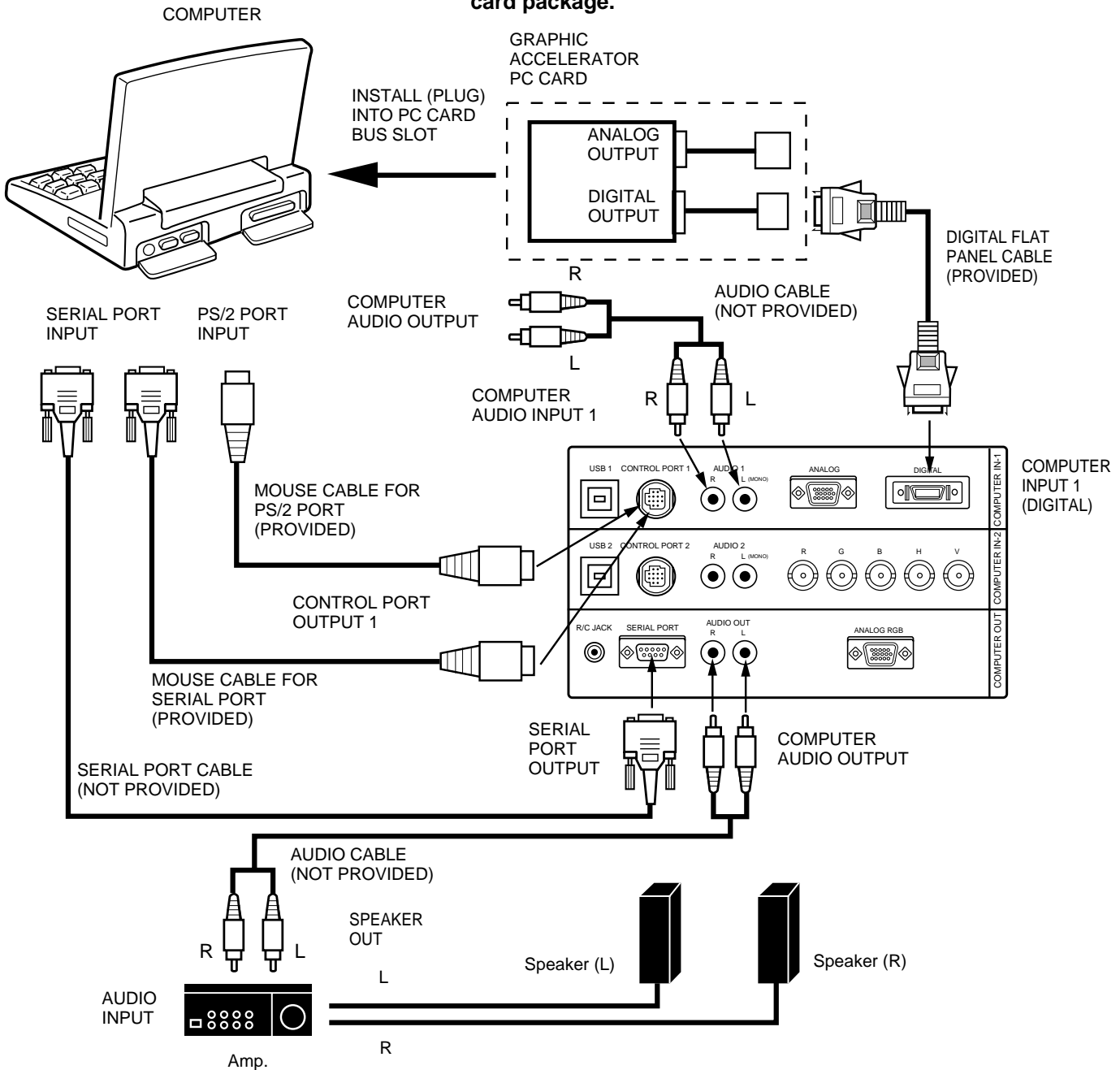

NOTE: When connecting the cable, the power cords of both the projector and the external equipment should be disconnected from AC outlet. Turn the projector and peripheral equipment on before the computer is switched on.

CONNECTING A MACINTOSH DESKTOP COMPUTER

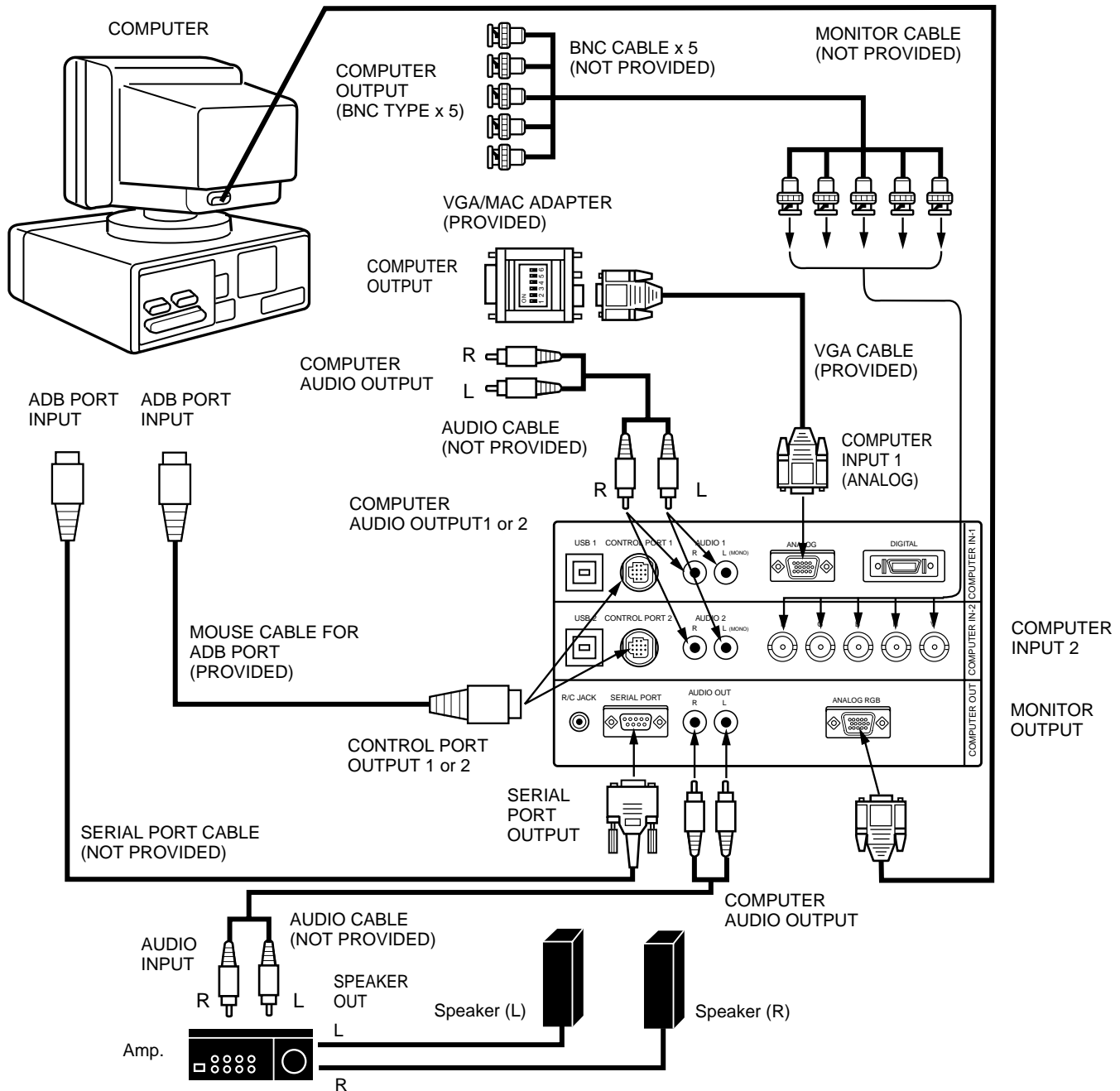

Set the dip switches as shown in the table below depending on the RESOLUTION MODE that you want to use before you turn on the projector and computer.

| RESOLUTION MODE | SW1 | SW2 | SW3 | SW4 | SW5 | SW6 |
|-----------------------|-----|-----|-----|-----|-----|-----|
| 13" MODE (640 x 480) | ON | ON | OFF | OFF | OFF | OFF |
| 16" MODE (832 x 624) | OFF | ON | OFF | ON | OFF | OFF |
| 19" MODE (1024 x 768) | OFF | ON | ON | OFF | OFF | OFF |
| 21" MODE (1152 x 870) | ON | ON | ON | ON | OFF | OFF |

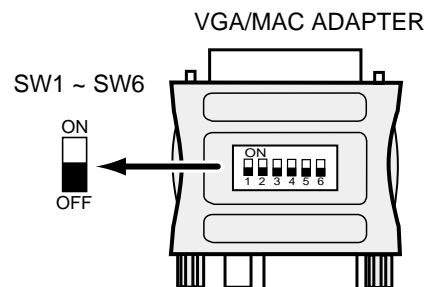

NOTE: When connecting the cable, the power cords of both the projector and the external equipment should be disconnected from AC outlet. Turn the projector and peripheral equipment on before the computer is switched on.

CONNECTING THE PROJECTOR

CONNECTING A MACINTOSH POWERBOOK COMPUTER

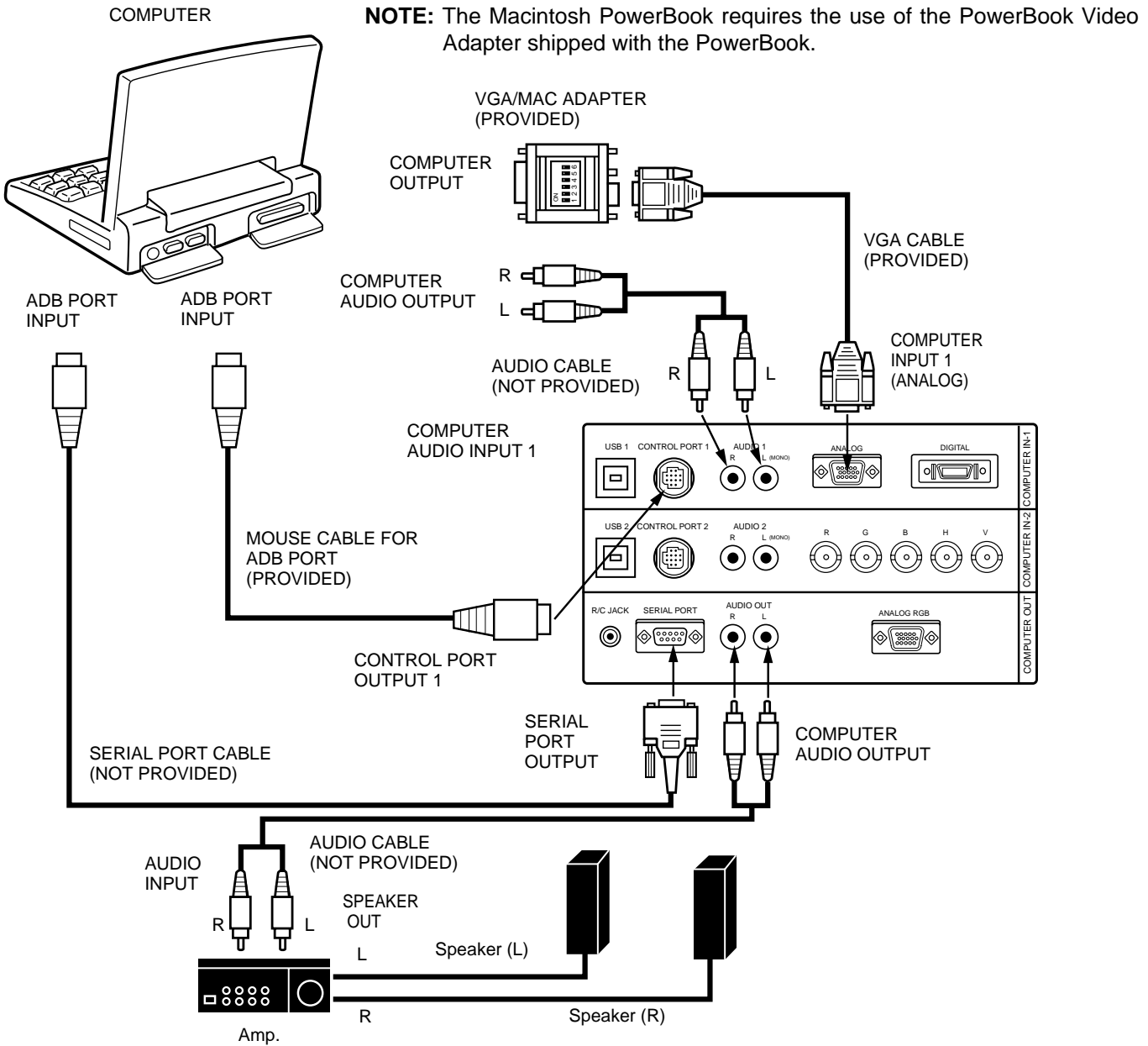

Set the dip switches as shown in the table below depending on the RESOLUTION MODE that you want to use before you turn on the projector and computer.

| RESOLUTION MODE | SW1 | SW2 | SW3 | SW4 | SW5 | SW6 |
|-----------------------|-----|-----|-----|-----|-----|-----|
| 13" MODE (640 x 480) | ON | ON | OFF | OFF | OFF | OFF |
| 16" MODE (832 x 624) | OFF | ON | OFF | ON | OFF | OFF |
| 19" MODE (1024 x 768) | OFF | ON | ON | OFF | OFF | OFF |
| 21" MODE (1152 x 870) | ON | ON | ON | ON | OFF | OFF |

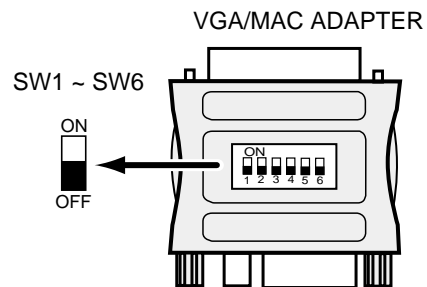

NOTE: When connecting the cable, the power cords of both the projector and the external equipment should be disconnected from AC outlet. Turn the projector and peripheral equipment on before the computer is switched on.

CONNECTING THE VIDEO EQUIPMENT

CONNECTING TO THE VIDEO INPUT JACKS (1 and 2) BNC TYPE x 3

Connect to the video outputs of a VCR, video disc player, DVD player, video camera, satellite TV tuner or other AV equipment. Connect video output from AV equipment to these jacks using the BNC cables.

The video input can be connected 3 types of signals; "COMPOSITE VIDEO", "Y/C SEPARATE VIDEO" and COMPONENT VIDEO {Y, Cb (B-Y), Cr (R-Y)}.

Set VIDEO SOURCE of each video input (VIDEO IN-1 or VIDEO IN-2) to input video matter. (Refer to "VIDEO SOURCE SELECT" operation on page 44).

CONNECTING S-VHS VIDEO INPUT JACKS (1 and 2)

The Video input includes an extra video input jack marked S-VIDEO to allow connection to an S-VHS format VCR that has separate Y/C video signals. The S-VIDEO jack has priority over the VIDEO jack.

CONNECTING TO THE AUDIO INPUT JACKS (1 and 2)

Connect to the audio outputs of a VCR, video disc player, DVD player, video camera, satellite TV tuner or other AV equipment. Use RCA type audio cable for connection.

- If the audio signal from the AV equipment is stereo, be sure to connect the right and left channels to the respective right and left audio input jacks.
- If the external audio signal is monaural, connect it to the left jack.

CONNECTING TO THE VIDEO MONITOR OUTPUT JACKS (BNC TYPE x 3)

These jacks will contain the video information of the selected program source being viewed on the screen (Video 1 or Video 2). If you have selected program source Video 2 the video signal connected to the Video 2 video input jack will be available at the video monitor output jacks. If you select program source "Computer 1" or "Computer 2", the video signal connected to the Video 1 video input jack will be available at the video monitor output jacks.

Use BNC cable for connection.

CONNECTING TO THE S-VHS VIDEO MONITOR OUTPUT JACK

The Video monitor output includes an extra video input jack marked S-VIDEO to allow connection to an S-VHS format VCR that has separate Y/C video signals. The S-VIDEO jack has priority over the VIDEO jack.

CONNECTING TO THE AUDIO MONITOR OUTPUT JACKS

These jacks will contain the audio information of the selected program source being viewed on the screen (Video 1 or Video 2). If you have selected program source Video 2 the audio signal connected to the Video 2 audio input jack will be available at the audio monitor output jacks. If you select program source "Computer 1" or "Computer 2", the audio signal connected to the Video 1 audio input jack will be available at the audio monitor output jacks.

Use RCA type audio cable for connection.

- If the audio input of the audio equipment is stereo, be sure to connect the right and left channels to the respective right and left jacks.
- If the audio input of the audio equipment is monaural, connect it to the left jack.

CONNECTING THE PROJECTOR

CONNECTING THE VIDEO EQUIPMENT

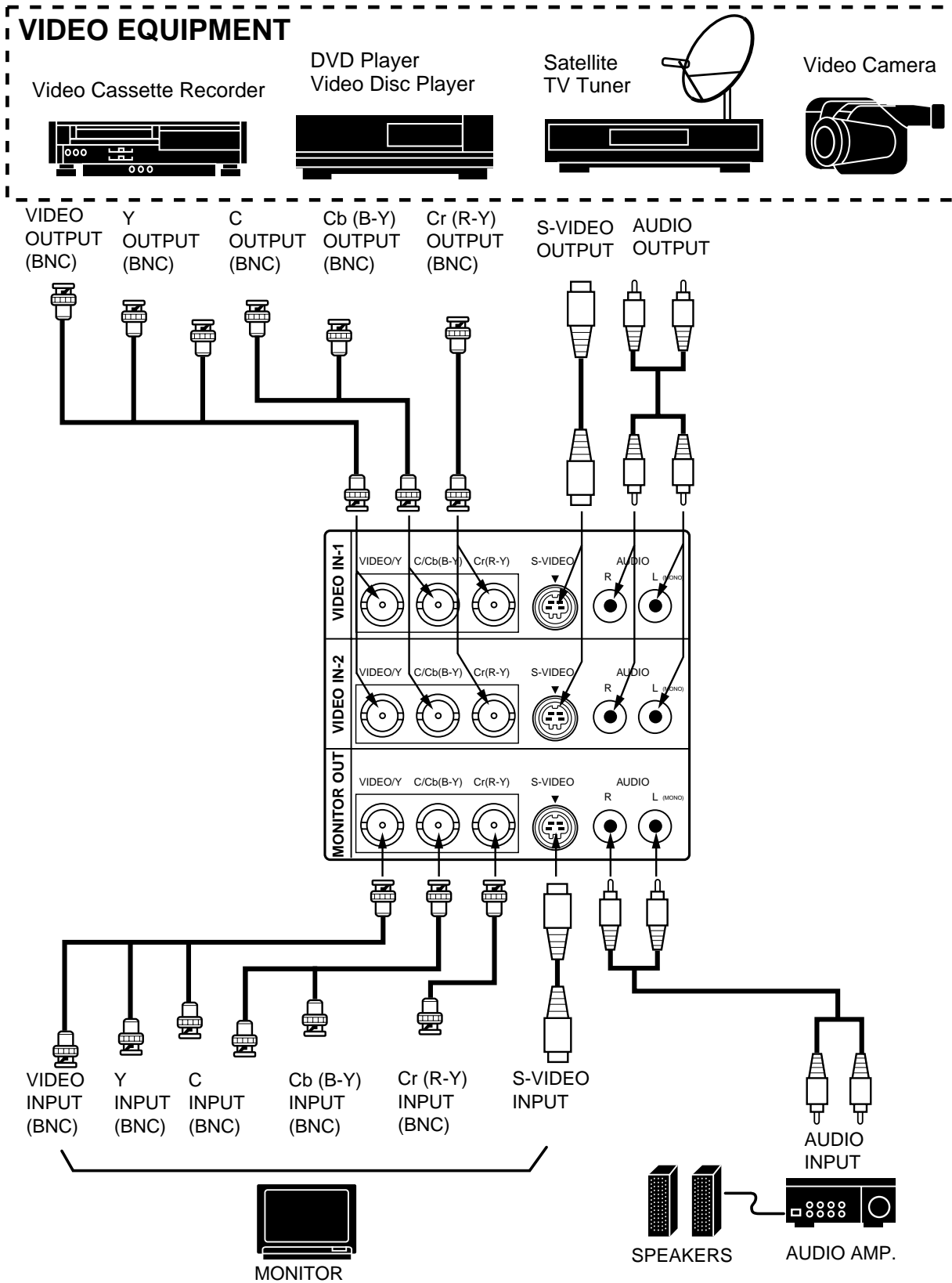

NOTE: When connecting the cable, the power cords of both the projector and the external equipment should be disconnected from AC outlet. Turn the projector on before the peripheral equipment is switched on.

BEFORE OPERATION

CONTROLS AND INDICATORS

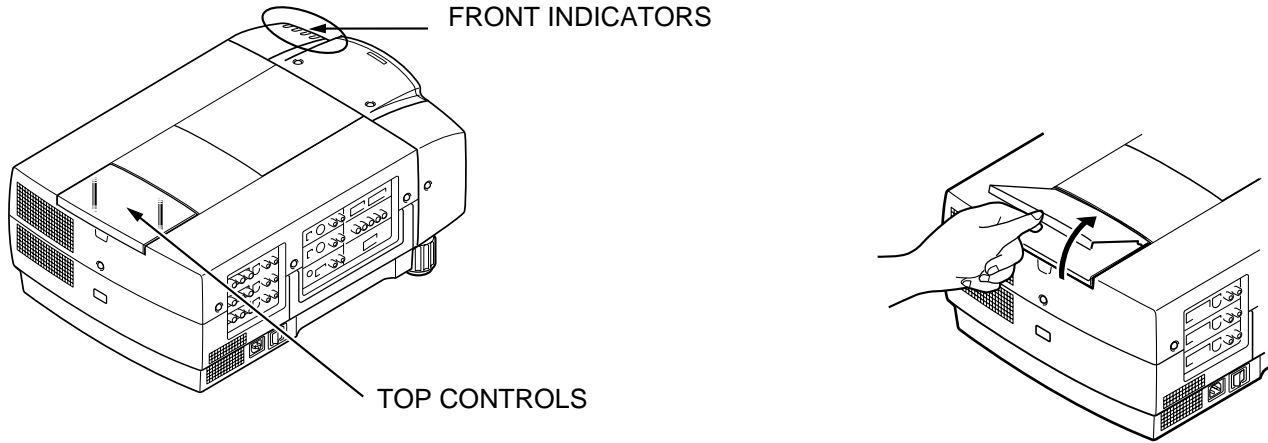

FRONT INDICATORS

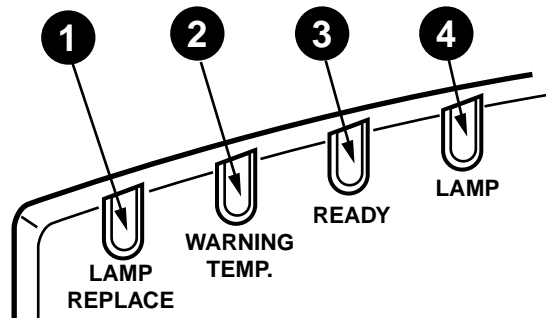

TOP CONTROLS

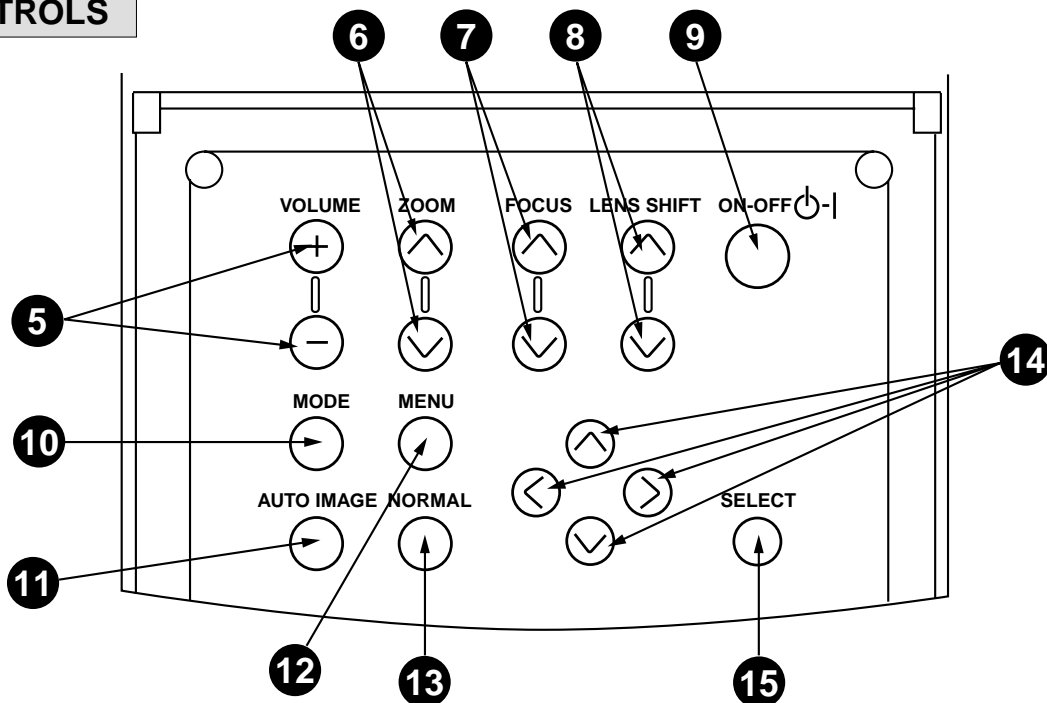

BEFORE OPERATION

- 1 LAMP REPLACEMENT INDICATOR**
Light is orange when the Lamp life draws to an end.
- 2 TEMPERATURE WARNING INDICATOR**
Flashes red when internal projector temperature is too high.
- 3 READY INDICATOR**
Light is green when projector lamp is ready to be turned on.
- 4 LAMP POWER INDICATOR**
Light is dim when the projector is on.
Light is brightened when the projector is in stand-by mode.
- 5 VOLUME BUTTONS**
Used to adjust volume.
- 6 ZOOM BUTTONS**
Used to operate power zoom lens.
- 7 FOCUS BUTTONS**
Used to operate power focus system.
- 8 LENS SHIFT BUTTONS**
Used to operate power lens shift.
- 9 POWER ON/OFF BUTTON**
Used to turn the projector on or off.
- 10 MODE BUTTON**
Used to select source.
(Computer 1, Computer 2, Video 1 or Video 2 Input)
- 11 AUTO IMAGE BUTTON**
Used to operate the AUTO IMAGE adjustment.
- 12 MENU BUTTON**
This button will activate the MENU operation.
Use this button, the POINT UP/DOWN/LEFT/RIGHT buttons and the SELECT button to make adjustments to the projector's setting in MENU operation.
- 13 NORMAL BUTTON**
Used to reset to normal picture adjustment preset by factory.
- 14 POINT UP/DOWN/LEFT/RIGHT BUTTONS**
To select an item on the MENU that you want to adjust. To select an item, move the arrow by pressing these buttons (UP, DOWN, LEFT or RIGHT).
- 15 SELECT BUTTON**
This button has different functions depending on when used. This button is used to execute the item selected, to increase or decrease the values in certain items such as CONTRAST or BRIGHTNESS.

OPERATION OF THE REMOTE CONTROL

WIRELESS REMOTE CONTROL UNIT

This remote control unit is not only able to operate the projector but also usable as a wireless mouse for a PC. One pointing pad and two click buttons are used for wireless mouse operation.

Wireless mouse is usable when PC mouse pointer is displayed on the screen. When the menu or indicator of the projector is displayed on the screen instead of the PC mouse pointer, the wireless mouse cannot be used.

NOTE: To use the unit as a PC wireless mouse, connect the projector to the PC with the attached cable. Signals from the projector are transmitted to the PC, enabling the remote control unit of the projector to be used as a PC wireless mouse. (Refer to "CONNECTING THE PROJECTOR" in pages 15 to 20 for the connection.)

LASER POINTER button

This remote control emits a laser beam light as the Laser Pointer from the Laser Light Window.

When the LASER POINTER button is pressed, laser light goes on: when the button is released, light goes off.

Laser light is emitted with the RED light indicating that the laser beam is being emitted.

The laser emitted is a class II laser; therefore, do not look into the laser light window or shine the laser beam on yourself or other people. The three marks to the right are the caution labels for the laser beam.

CAUTION-use of controls or adjustments or performance of procedures other than those specified herein may result in hazardous radiation exposure.

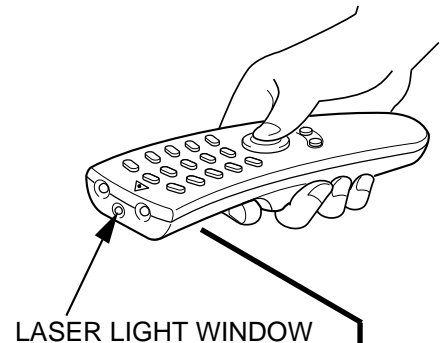

LASER LIGHT WINDOW



AVOID EXPOSURE-LASER RADIATION IS EMITTED FROM THIS APERTURE
レーザー光の出口
ビームをのぞき込まないこと

CAUTION

LASER RADIATION-
DO NOT STARE INTO BEAM



MAX OUTPUT : 1mW
WAVE LENGTH : 660±20nm
CLASS II LASER PRODUCT

This product is complied with 21 CFR
part 1040.10

LASER RADIATION
DO NOT STARE INTO BEAM
CLASS 2 LASER PRODUCT
LASER-STRAHLUNG
NICHT IN DEN STRAHL BLICKEN
LASER KLASSE 2
レーザー放射 クラス2 レーザ製品
ビームをのぞき込まないこと
IEC60825-1, Am.1 1997
MAX OUTPUT (最大出力) : 1mW
WAVE LENGTH (波長) : 660±20nm

FRONT

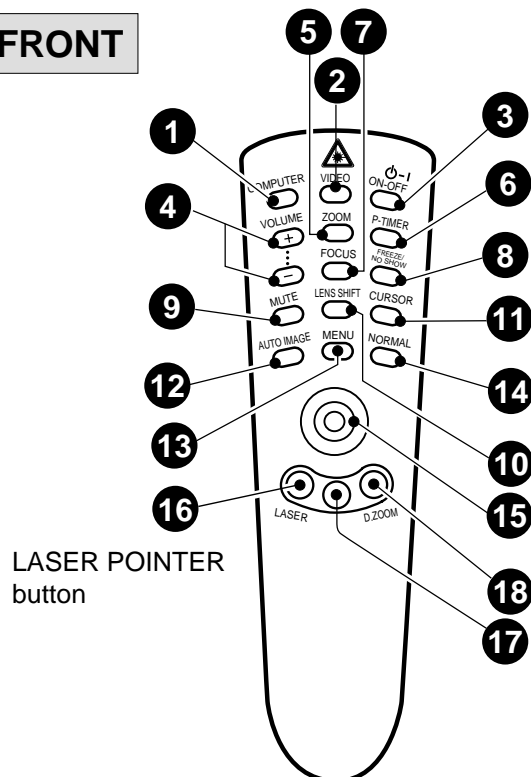

LASER POINTER
button

SIDE

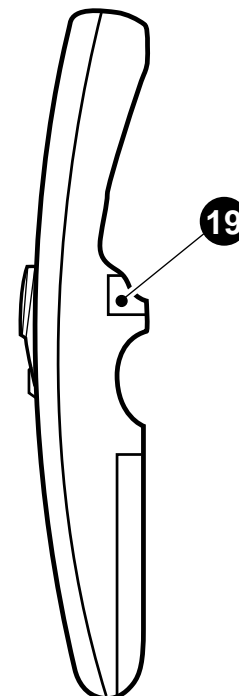

BASIC OPERATION

- 1 COMPUTER SELECT BUTTON**
Used to select computer mode. (Computer 1 or Computer 2 Input)
- 2 VIDEO SELECT BUTTON**
Used to select video mode. (Video 1 or Video 2 Input)
- 3 POWER ON/OFF BUTTON**
Used to turn the projector on or off.
- 4 VOLUME BUTTONS**
Used to adjust volume.
- 5 ZOOM BUTTON**
Used to select power zoom lens adjust.
- 6 P-TIMER BUTTON**
Used to operate the P-TIMER function.
- 7 FOCUS BUTTON**
Used to select focus adjust.
- 8 FREEZE/NO SHOW BUTTON**
Used to freeze on-screen image or change the screen into black image.
- 9 SOUND MUTE BUTTON**
Used to mute sound.
- 10 LENS SHIFT BUTTON**
Used to select power lens shift.
- 11 CURSOR BUTTON**
Used to display CURSOR on the screen.
- 12 AUTO IMAGE BUTTON**
Used to operate the AUTO IMAGE adjustment.
- 13 MENU BUTTON**
This button will activate the MENU operation. Use this button, the POINT UP/DOWN/LEFT/RIGHT button and the SELECT (REAR CLICK) button to make adjustments to the projector's setting in MENU operation.
- 14 NORMAL BUTTON**
Use to reset to normal picture adjustment preset by factory.
- 15 POINTING PAD (POINT UP/DOWN/LEFT/RIGHT BUTTON)**
When in use as a remote for the projector
To select an item on the MENU that you want to adjust. To select an item, move the arrow by pressing the pad upward, downward, leftward or rightward.
Used to operate power zoom lens, power focus system or power lens shift by pressing the pad either upward or downward.
When in use as a wireless mouse
Used to move the pointer. The pointer is moved according to the direction you are pressing.
- 16 LASER BUTTON**
When this button is pressed, laser light goes on; when the button is released, light goes off.
- 17 FRONT CLICK BUTTON**
When in use as a remote for the projector
Used to compress the image in D.ZOOM mode.
When in use as a wireless mouse
This button has the same function as the right button in a PC mouse.
- 18 DIGITAL ZOOM BUTTON**
Used to select digital zoom function.
- 19 SELECT (REAR CLICK) BUTTON**
When in use as a remote for the projector.
This button has different functions depending on when used. This button is used to execute the item selected, to increase or decrease the values in certain items such as CONTRAST or BRIGHTNESS.
When in use as a wireless mouse
This button has the same function as the left button in a PC mouse.

Remote Control Battery Installation

1 Remove the battery compartment lid.

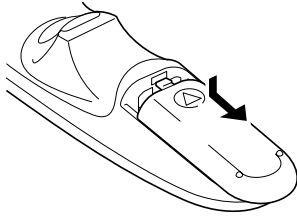

2 Slide the batteries into the compartment.

Note : For correct polarity (+ and - terminal), be sure the battery terminals are in contact with the pins in the compartment.

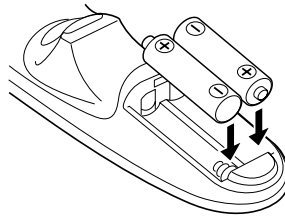

3 Replace the compartment lid.

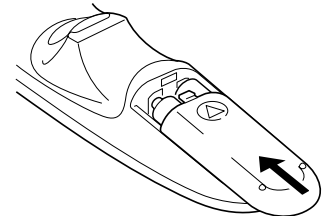

Using the Remote Control Unit

Point the remote control toward the projector (Receiver window) whenever pressing the buttons. Maximum operating range for the remote control is about 16.4' (5m) and 60° front and rear of the projector.

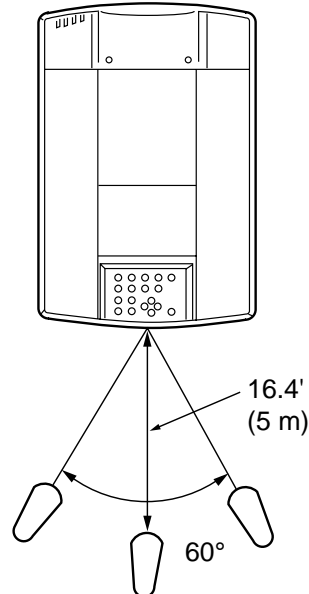
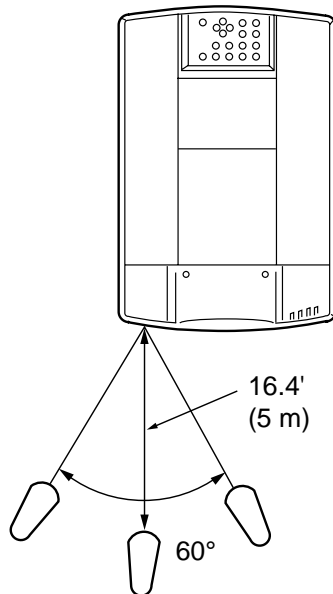

To insure safe operation, please observe the following precautions :

- Use (2) AA type alkaline batteries.
- Change two batteries at the same time.
- Do not use a new battery with a used battery.
- Avoid contact with water.
- Do not drop the remote control unit.
- If batteries have leaked on the remote control, carefully wipe the case clean and load new batteries.

WIRELESS/WIRED REMOTE CONTROL UNIT

- 1 WIRED REMOTE JACK**
When using the wired remote control, connect the remote cable to this jack.
- 2 COMPUTER SELECT BUTTON**
Used to select computer mode.
(Computer 1 or Computer 2 Input)
- 3 VIDEO SELECT BUTTON**
Used to select video mode. (Video 1 or Video 2 Input)
- 4 POWER ON/OFF BUTTON**
Used to turn projector on or off.
- 5 VOLUME BUTTONS**
Used to adjust volume.
- 6 ZOOM BUTTONS**
Used to operate power zoom lens.
- 7 FOCUS BUTTONS**
Used to operate power focus system.
- 8 SOUND MUTE BUTTON**
Used to mute sound.
- 9 LENS SHIFT BUTTONS**
Used to operate power lens shift.
- 10 P-TIMER BUTTON**
Used to operate the P-TIMER function.
- 11 AUTO IMAGE BUTTON**
Used to operate the AUTO IMAGE adjustment.
- 12 MENU BUTTON**
This button will activate the MENU operation.
Use this button, the POINT UP/DOWN/LEFT/RIGHT buttons and the SELECT button to make adjustments to the projector's setting in MENU operation.
- 13 POINT UP/DOWN/LEFT/RIGHT BUTTONS**
To select an item on the MENU that you want to adjust. To select an item, move the arrow by pressing these buttons (UP, DOWN, LEFT or RIGHT).
- 14 FREEZE/NO SHOW BUTTON**
Used to freeze on-screen image or change the screen into black image.
- 15 SELECT BUTTON**
This button has different functions depending on when used. This button is used to execute the item selected, to increase or decrease the values in certain items such as CONTRAST or BRIGHTNESS.
- 16 DIGITAL ZOOM BUTTON**
Use to select digital zoom function.
- 17 NORMAL BUTTON**
Used to reset to normal picture adjustment preset by factory.

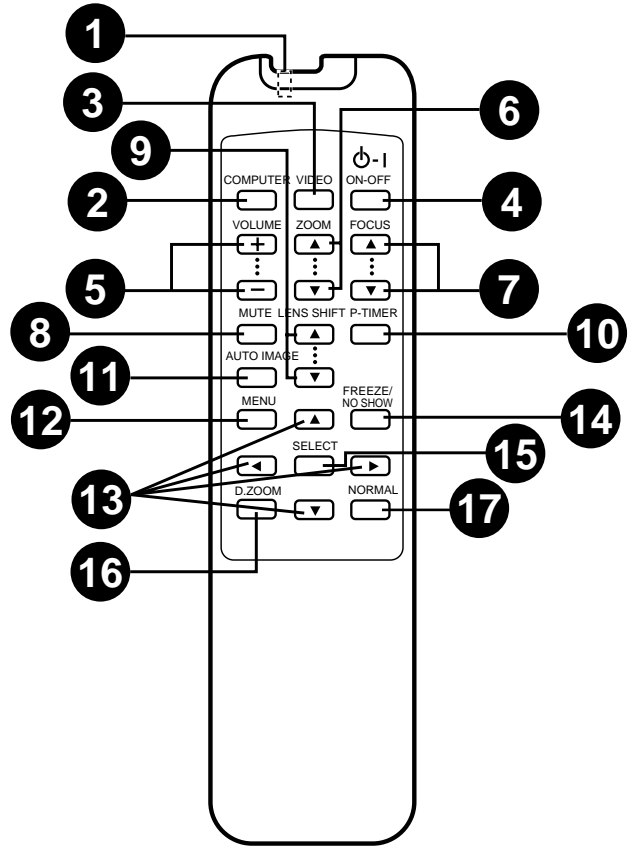

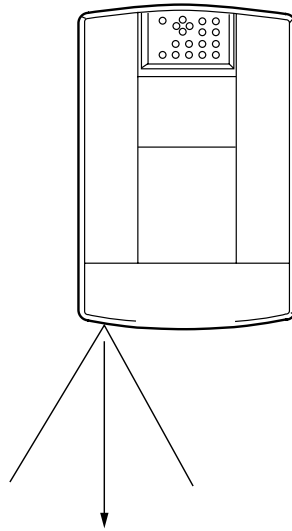

OPERATING ON-SCREEN MENU

HOW TO OPERATE ON-SCREEN MENU

You can control and adjust this projector through the ON-SCREEN MENU. Refer to the following pages to operate each adjustment in the ON-SCREEN MENU.

1 MOVING THE POINTER

Move the pointer (see the NOTE below) by pressing POINT button(s) on the TOP CONTROL or on the REMOTE CONTROL.

2 SELECT THE ITEM

Select the item by pressing SELECT (REAR CLICK) button.

NOTE : Pointer is the icon on the ON-SCREEN Menu to select the item. See the figures on the section "FLOW OF ON-SCREEN MENU" below.

TOP CONTROL



POINT BUTTONS

Used to move the Pointer UP/ DOWN/ RIGHT/ LEFT.

SELECT BUTTON
Used to select the item.

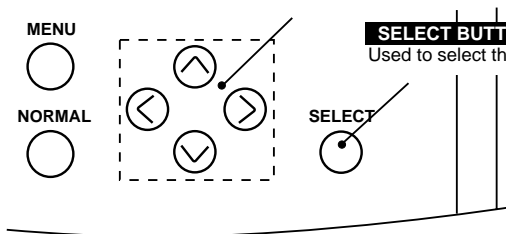

WIRELESS REMOTE CONTROL

POINT BUTTON

Used to move the Pointer UP/ DOWN/ RIGHT/ LEFT.

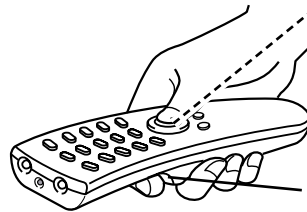

SELECT BUTTON

Used to select the item.

WIRELESS/WIRED REMOTE CONTROL

SELECT BUTTON

Used to select the item.

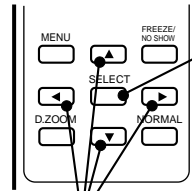

POINT BUTTONS

Used to move the Pointer UP/ DOWN/ RIGHT/ LEFT.

FLOW OF ON-SCREEN MENU

Display ON-SCREEN MENU

- 1 Press MENU button to display the ON-SCREEN MENU (MENU BAR). The red frame is the POINTER.

Select the Item

- 2 Move the POINTER (red frame) to the ITEM ICON that you want to select by pressing POINT RIGHT / LEFT buttons.
- 3 Select the ITEM by pressing SELECT (REAR CLICK) button. The dialog box of the ITEM appears.

Control and adjust through ON-SCREEN MENU

- 4 Move the POINTER downward by pressing POINT DOWN button. (The shape of the POINTER becomes an arrow.)
- 5 Move the POINTER to the ITEM that you want to adjust and adjust the ITEM by pressing SELECT (REAR CLICK) button. Refer to the following pages for details of respective adjustments.

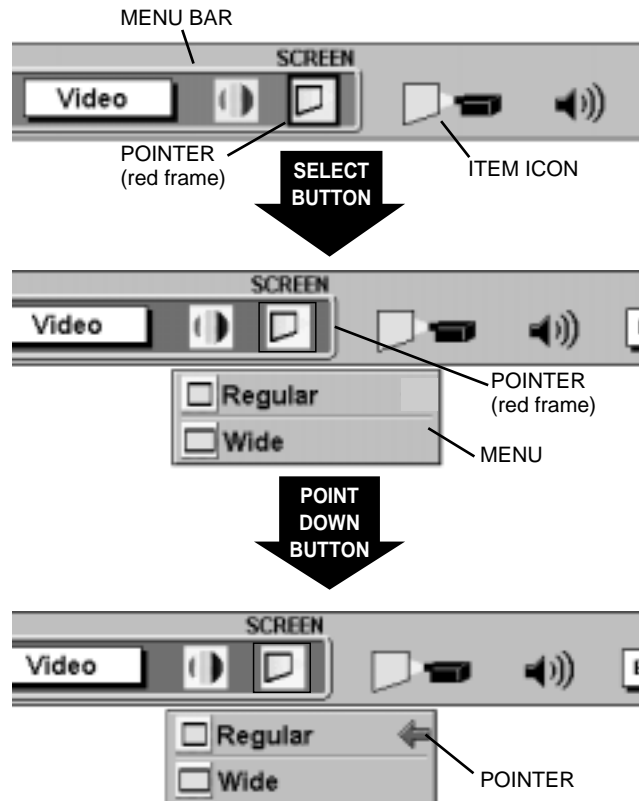

MENU BAR

MENU BAR IN COMPUTER MODE

Press MENU BUTTON while in Computer mode.

The diagram shows the menu bar in Computer mode with the following callouts:

- MODE MENU**: Used to select the Computer input mode. (Refer to P36)
- AUTO IMAGE MENU**: Used to adjust Fine sync, Total dots, and Picture Position automatically. (Refer to P41)
- PC ADJUST MENU**: Used to adjust the parameters to match with the input signal format. (Refer to P38, 39)
- SETTING MENU**: Used to set the Display Menu and reset Lamp Replacement Monitor Timer. (Refer to P48, 49)
- LANGUAGE MENU**: Used to select the language used in the Menu. (Refer to P49)
- SYSTEM MENU**: Used to select a computer system. (Refer to P36)
- IMAGE MENU**: Used to adjust the computer image. [Fine sync / Total dots / White Balance / Contrast / Brightness / Sharpness] (Refer to P40)
- POSITION MENU**: Used to adjust the position of the image. (Refer to P42)
- SCREEN MENU**: Used to adjust the size of the image. (Refer to P43)
- SOUND MENU**: Used to adjust or mute the Volume. (Refer to P35)

MENU BAR IN VIDEO MODE

Press MENU BUTTON while in Video mode.

The diagram shows the menu bar in Video mode with the following callouts:

- MODE MENU**: Used to select the Video input. (Refer to P44)
- IMAGE MENU**: Used to adjust the picture image. [Color / Tint / White Balance / Contrast / Brightness/ Sharpness] (Refer to P46)
- SYSTEM MENU**: Used to select a color system of the selected video source. (Refer to P45)
- VIDEO SOURCE MENU**: Used to select a video source among [(Video), (Y,C) and (Y, Cb, Cr)]. (Refer to P44)
- SCREEN MENU**: Used to set the size of the image either Regular or Wide. (Refer to P47)

Additional callouts for the menu bar in Video mode:

- Two callouts pointing to the 'Auto' buttons: "Same function as the Computer Mode."
- One callout pointing to the screen size icon: "Same function as the Computer Mode."

BASIC OPERATION

TURNING ON/OFF THE PROJECTOR

TO TURN ON THE PROJECTOR

Connect the projector to a source (Computer, VCR, Video Camera, Video Disc Player, etc.) using the appropriate terminals on the side of the projector (See "CONNECTING THE PROJECTOR" section on pages 13-22).

Connect the projector's AC power cord into a wall outlet and turn the MAIN ON/OFF switch (located on the side of the projector) to the ON position. The LAMP POWER indicator will light RED, the READY indicator will light GREEN.

Press the POWER ON/OFF button on the remote control unit or on the projector to ON. The LAMP POWER indicator light will dim and the cooling fans will operate. The wait display appears on the screen and the count-down starts (30-29-28-...1). The signal from the source appears after 30 seconds.

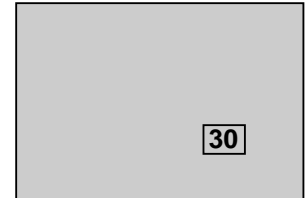

TO TURN OFF THE PROJECTOR

Press the POWER ON/OFF button on the remote control unit or on the projector. The "Power off ?" appears on the screen. Press again the POWER ON/OFF button to turn OFF the projector. The LAMP POWER indicator will light bright and READY indicator will turn off. The cooling fans will operate for 90 seconds after the projector is turned off. (During this "cooling down" period, the projector cannot be turned on.) The READY indicator will light green again and the projector may be turned on by pressing the POWER ON/OFF button. To power down completely, turn the MAIN ON/OFF switch (located on the side of the projector) to the OFF position.



TO MAINTAIN THE LIFE OF THE LAMP, ONCE YOU TURN THE PROJECTOR ON, WAIT AT LEAST 5 MINUTES BEFORE TURNING IT OFF.

When the Power Management function is ON, the Projector detects the signal interruption and turns the Projection Lamp off automatically. Refer to "Power Management" on page 48.

When the TEMPERATURE WARNING indicator flashes red, the projector is automatically turned off. Wait at least 5 minutes before turning the projector on again.

When the TEMPERATURE WARNING indicator continues to flash, follow procedures below:

1. Turn the MAIN ON / OFF SWITCH to OFF and disconnect the AC power cord from the AC outlet.
2. Check the air filters for dust accumulation.
3. Clean the Air Filter. (See "AIR FILTER CARE AND CLEANING" section on page 51.)
4. Turn the Projector on again.

If the TEMPERATURE WARNING indicator should still continue to flash, contact the sales dealer where you purchased this projector or service center.

NOTE: The Cooling Fan may work for cooling while the projector is turned off. When the Cooling Fan is working, TEMPERATURE WARNING INDICATOR flashes red.

ADJUSTING THE IMAGE

ZOOM ADJUSTMENT

Use Top control and Wireless/Wired remote control unit.

Press the ZOOM (▲) or (▼) button to obtain your desired picture size. For a larger picture, press (▲) and for a smaller picture, press (▼).

Use Wireless remote control unit.

Press the ZOOM button and press POINT UP/DOWN button(s) to obtain your desired picture size. The Zoom display will be displayed on the screen for a few seconds. For a larger picture, press (UP) and for a smaller picture, press (DOWN).

 A rectangular button with the word "Zoom" centered inside.

FOCUS ADJUSTMENT

Use Top control and Wireless/Wired remote control unit.

Press the FOCUS (▲) or (▼) button for a sharper, crisper picture.

Use Wireless remote control unit.

Press the FOCUS button and press POINT UP/DOWN button(s) to obtain a sharper, crisper picture. The Focus display will be displayed on the screen for a few seconds.

 A rectangular button with the word "Focus" centered inside.

LENS SHIFT FUNCTION

Use Top control and Wireless/Wired remote control unit.

Press the LENS SHIFT (▲) or (▼) button to obtain your desired screen position.

Use Wireless remote control unit.

Press the LENS SHIFT button and press POINT UP/DOWN button(s) to obtain your desired screen position. The Lens shift display will be displayed on the screen for a few seconds.

 A rectangular button with the words "Lens shift" centered inside.

DIGITAL ZOOM FUNCTION

Press the D. ZOOM button on the wireless remote control unit. The "D.zoom" and the magnifying-glass icon is displayed to indicate Digital zoom mode. Digital zoom mode can be adjust the image size or pan the image.

To expand the image size, press SELECT (REAR CLICK) button. The image is magnified by degrees (Expand function).

To compress the image size, press FRONT CLICK button. The size of image is reduced by degrees (Compress function).

To pan the image, press POINT UP/DOWN/LEFT/RIGHT (POINTING PAD) button(s). The image move to the direction indicated (Panning function)

See the page 43 for more detail.

 A rectangular display area with a thin black border. In the top-left corner, the text "D. zoom" is displayed. In the center, there is a small magnifying-glass icon.

NORMAL PICTURE FUNCTION

The normal picture image level is factory preset on the projector and can be restored anytime by pressing the NORMAL button on the projector or on the remote control unit. The "Normal" display will be displayed on the screen for a few seconds.

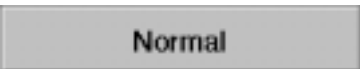
 A rectangular button with the word "Normal" centered inside.

FREEZE PICTURE FUNCTION

Press the FREEZE/NO SHOW button on the remote control unit, and the picture will remain on-screen. This function is cancelled when the FREEZE/NO SHOW button is pressed again or any other button is pressed.

NOTE: Your computer or video equipment is not affected by this function, and will continue to run.

NO SHOW FUNCTION

Press the FREEZE/NO SHOW button (on the remote control unit) is twice. The screen will change into black image and the "No show" is displayed on the screen for a few seconds.

This function is cancelled when the FREEZE/NO SHOW button is pressed again or any other function button is pressed.

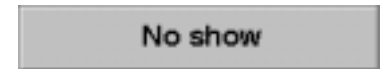

P-TIMER FUNCTION

Press the P-TIMER button on the remote control unit. The timer display "00:00" appears on the screen and the timer starts to count the time (00:00 to 59:59).

Press again the P-TIMER button to stop the timer. Then press the P-TIMER button to cancel the P-TIMER function.

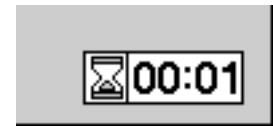

AUTO IMAGE ADJUSTMENT

Press the AUTO IMAGE button on the projector or on the remote control unit. The item(s) indicated "ON" in the AUTO IMAGE ADJUSTMENT are adjusted automatically.

If all the items in AUTO IMAGE ADJUSTMENT are "OFF", AUTO IMAGE SETTING display appears. If you wish to operate the AUTO IMAGE ADJUSTMENT, perform the steps 1 - 3 of "AUTO IMAGE ADJUSTMENT" section on page 41.

CURSOR FUNCTION

Press the CURSOR button on the wireless remote control unit. The CURSOR is displayed on the screen. Press POINT UP/DOWN/LEFT/RIGHT (POINTING PAD) button(s) to control CURSOR. The CURSOR is moved according to the direction you are pressing. Press CURSOR button again, and CURSOR disappears.

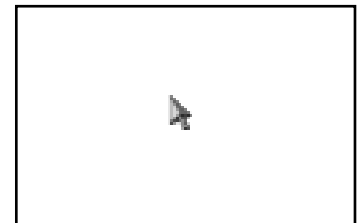

SOUND ADJUSTMENT

DIRECT OPERATION

Sound Volume Adjustment

Press the VOLUME (+/-) button(s) on the Top Control or on the Remote Control Unit to adjust the volume. The Volume dialog box appears on the screen for a few seconds.

(+) button to increase the volume, and (-) button decreasing.

Sound Mute Setting

Press the MUTE button on the Remote Control Unit to cut off the sound. To restore the sound to its previous level, press the MUTE button again or press Volume (+/-) button(s).

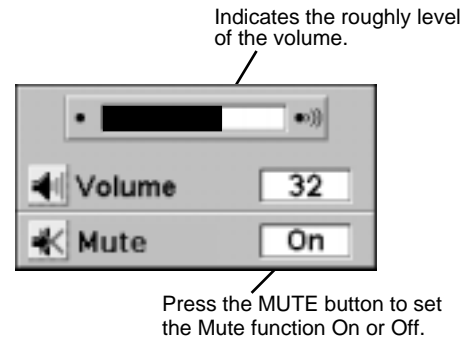

The display disappears after 4 seconds.

MENU OPERATION

- 1 Press the MENU button and the ON-SCREEN MENU will appear. Press the POINT LEFT/RIGHT buttons to select SOUND and press the SELECT (REAR CLICK) button. Another dialog box SOUND ADJUST Menu will appear.
- 2 Press the POINT DOWN button and a red-arrow icon will appear. Move the arrow to the item that you want to select by pressing the POINT UP/DOWN buttons.

Volume

Move the arrow to ▲ or ▼ of "Volume" by pressing the POINT UP/DOWN buttons. To increase the volume, point the arrow to ▲ and then press the SELECT (REAR CLICK) button. To decrease the volume point the arrow to ▼ and then press the SELECT (REAR CLICK) button.

Treble

To adjust the Treble sound, point the arrow to ▲ or ▼ of "Treble" and then press the SELECT (REAR CLICK) button.

Bass

To adjust the Bass sound, point the arrow to ▲ or ▼ of "Bass" and then press the SELECT (REAR CLICK) button.

Built-in SP.

To disconnect the built-in speaker, point the arrow to Built-in SP. and then press the SELECT (REAR CLICK) button. The Built-in SP. display is changed Off from On and Internal speaker is disconnected.

Mute

To cut off the audio sound, point the arrow to "Mute" and then press the SELECT (REAR CLICK) button. The Mute display is changed On from Off and the sound is cut off. To restore the sound to its previous volume level, set the Mute to Off.

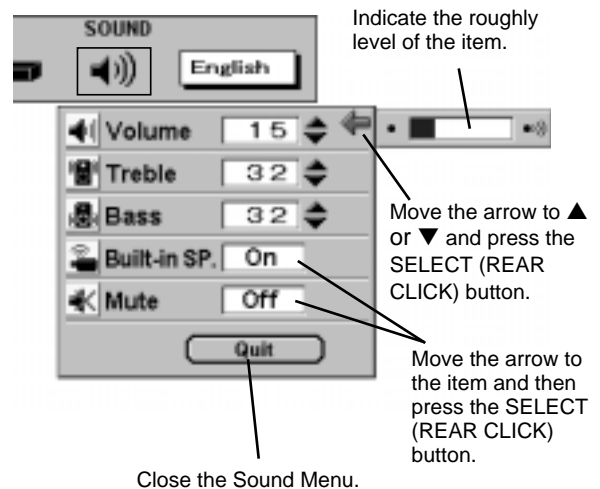

COMPUTER MODE

SELECTING COMPUTER MODE

DIRECT OPERATION

Press the MODE button on the projector or the COMPUTER button on the remote control unit to select Computer 1, Computer 2 Input. The "Computer 1", or "Computer 2" display will appear on the screen for a few seconds.

MENU OPERATION

- 1 Press the MENU button and the ON-SCREEN MENU will appear. Press the POINT LEFT/RIGHT buttons to select Computer and press the SELECT (REAR CLICK) button. Another dialog box COMPUTER MODE Menu will appear.
- 2 Press the POINT DOWN button and a red-arrow icon will appear. Move the arrow to the mode either Computer 1 or Computer 2, and then press the SELECT (REAR CLICK) button.

CURRENT MODE DISPLAY

When selecting the Computer Mode, the Current Mode display appears to show the information of the computer being selected.

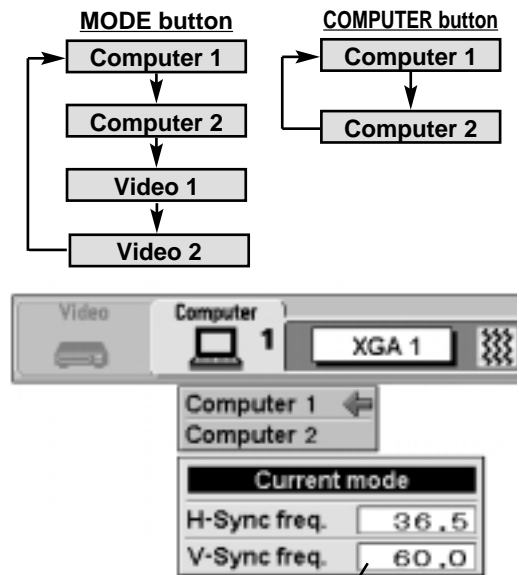

Providing the information of the computer detected by the projector.

SELECTING COMPUTER SYSTEM

AUTOMATIC MULTI-SCAN SYSTEM

This projector automatically tunes to most different types of computers based on VGA, SVGA, XGA, SXGA or UXGA (refer to "COMPATIBLE COMPUTER SPECIFICATION" on page 37). When selecting Computer, this projector automatically tunes to the incoming signal and projects the proper image without any special settings. (Setting of the Computer System may be required when connecting some computers.)

Note : The projector may display one of the following messages.

Go to PC adj. The projector cannot discriminate or detect the input signal from the computer. Adjust and set the computer system manually. (Refer to page 38.)

No signal There is no signal input from the computer. Make sure the connection of the computer and the projector is set correctly. (Refer to TROUBLESHOOTING on page 53.)

If the incoming signal is digital, the "D-VGA", "D-SVGA", "D-XGA", "D-SXGA" or "D-UXGA" display appears.

SELECT COMPUTER SYSTEM MANUALLY

To set the Computer system manually, select the mode on the ON-SCREEN MENU.

- 1 Press the MENU button and the ON-SCREEN MENU will appear. Press the POINT LEFT/RIGHT buttons to select SYSTEM and press the SELECT (REAR CLICK) button. Another dialog box COMPUTER SYSTEM Menu will appear.
- 2 Press the POINT DOWN button and a red-arrow icon will appear. Move the arrow to the system that you want to set, and then press SELECT (REAR CLICK) button.



SYSTEM BOX

Display the SYSTEM being selected.

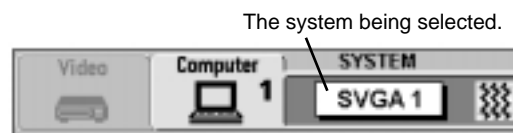

The system being selected.

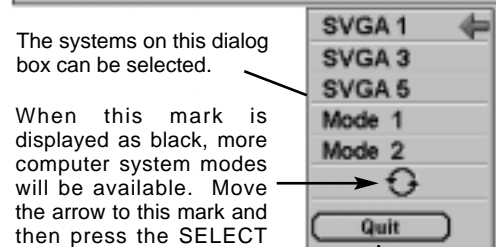

The systems on this dialog box can be selected.

When this mark is displayed as black, more computer system modes will be available. Move the arrow to this mark and then press the SELECT (REAR CLICK) button, and the other modes will be displayed.

Close the SYSTEM Menu.

COMPATIBLE COMPUTER SPECIFICATIONS

| ON-SCREEN DISPLAY | RESOLUTION | H-Freq. (kHz) | V-Freq. (Hz) |
|-------------------|------------|---------------|-----------------------|
| | | | SXGA1 64.20 |
| | | | SXGA2 62.50 |
| | | | SXGA3 63.90 |
| | | | SXGA4 63.34 |
| | | | SXGA5 63.74 |
| | | | SXGA6 71.69 |
| | | | SXGA7 81.13 |
| | | | SXGA8 |
| | | | SXGA9 |
| | | | SXGA10 |
| | | | SXGA11 UXGA1 |
| | | | SXGA12 Tm -044.86.GA2 |
| | | | SXGA13 |
| | | | SXGA14 |
| | | | SXGA15 |
| | | | SXGA16 |
| | | | SXGA17 |
| | | | SXGA18 |
| | | | SXGA19 |
| | | | SXGA20 |
| | | | MAC21 |
| | | | MAC |
| | | | MAC |
| | | | UXGA1 |
| | | | UXGA2 |
| | | | UXGA3 |
| | | | UXGA4 |
| | | | RGB |
| | | | RGB |
| | | | HDTV720p |
| | | | HDTV1035i |
| | | | HDTV1080i |

Specifications are subject to change without notice.

NOTE: Basically this projector can accept the signal from all computers with the above mentioned V, H-Frequency and less than 220 MHz of Dot Clock.

PC ADJUSTMENT

This Projector can automatically tune to the display signals from most personal computers currently distributed. However, some computers employ special signal formats which are different from the standard ones and may not be tuned by the Multi-Scan system of this projector. If this happens, the projector cannot reproduce a proper image and the image may be recognized as a flickering picture, a non-synchronized picture, a non-centered picture or a skewed picture.

This projector has a PC ADJUSTMENT function to enable you to precisely adjust several parameters to match with those special signal formats. This projector has 8 independent memory areas to memorize those parameters manually adjusted. This enables you to recall the setting for a specific computer whenever you use it.

Note : This PC ADJUSTMENT function will be skipped when the incoming signal is digital.

- 1 Press the MENU button and the ON-SCREEN MENU will appear. Press the POINT RIGHT/LEFT button to select PC ADJUST and press the SELECT (REAR CLICK) button. Another dialog box "Where to reserve" Menu will appear.
- 2 In this dialog box, you can store the parameter into the area from "Mode 1" to "Mode 8." When memorizing the new computer parameter, select the Mode with the message "Free" by pressing the POINT UP/DOWN button and the SELECT (REAR CLICK) button. To change the parameters of the Mode previously set, select the Mode with "Stored."
- 3 When the Mode is selected, Parameter adjustment dialog box appears. Move the arrow to the item that you want to change by pressing the POINT UP/DOWN button, and adjust each item by pressing the SELECT (REAR CLICK) button to match with your computer.
- 4 Move the arrow to "Stored" and press the SELECT (REAR CLICK) button. The parameter is memorized in the selected Mode.
- 5 To activate the Mode manually adjusted in this PC ADJUSTMENT Menu, select the Mode at the SYSTEM SELECT Menu. (Refer to page 36.)

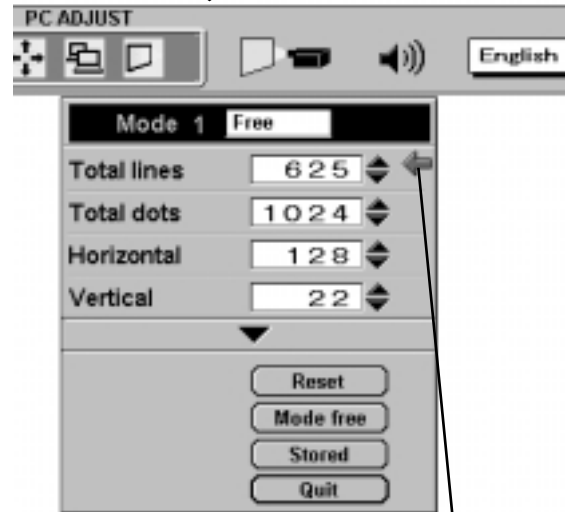
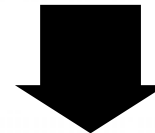
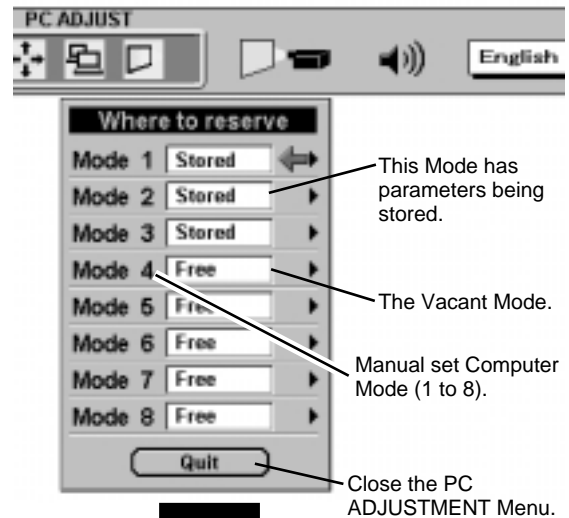

Move the arrow to ▲ or ▼ and press SELECT (REAR CLICK) button.

Total lines

The number of the total vertical lines. Adjust the number to match the image of your personal computer.

Total dots

The number of the total dots in one horizontal period. Adjust the number to match the image of your computer.

Horizontal / Vertical

Adjustment of the horizontal or vertical picture position. When the image is not centered on the screen, adjust each of those items.

Clamp

Adjustment of the clamp level. When the image has a dark bar(s), try this adjustment.

Fine sync

Adjust the picture as necessary to eliminate flicker from the display.

Display area

Adjustment of the area displayed with this projector. Select the resolution at the Display area dialog box, or adjust the number at the column of "H" or "V" to match the resolution of the image.

Horizontal Scale / Vertical Scale

Adjustment of the horizontal height or vertical width of the image.

NOTE : The Display area, the Horiz. scale and the Vert. scale cannot be adjusted when "HDTV1035i" or "HDTV1080i" is selected on the SYSTEM MENU (P24 and 25).

Each of the keys operates as follow.

- Reset** Recalls the parameter data that was previously adjusted.
- Mode free** Clears the parameter data previously set.
- Stored** Stores the parameters in the memory.
- Quit** Closes the PC ADJUST Menu.

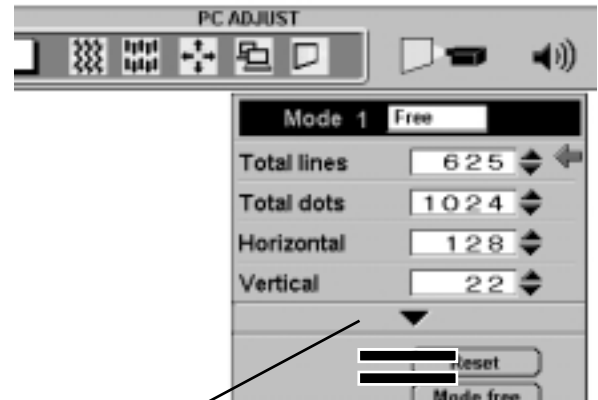

Press the SELECT (REAR CLICK) button at this column to adjust "Clamp," "Fine sync," "Display area," "Horiz. scale" or "Vert. scale" .

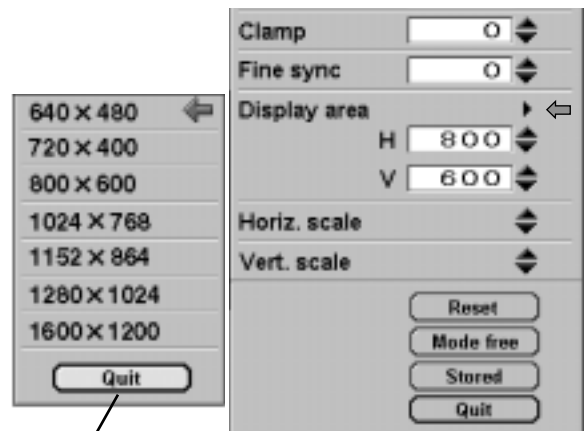

Point the arrow at the Display area and press the SELECT (REAR CLICK) button. The Display area dialog box appears.

PICTURE IMAGE ADJUSTMENTS

- 1 Press the MENU button and the ON-SCREEN MENU will appear. Press the POINT LEFT/RIGHT buttons to select IMAGE and press the SELECT (REAR CLICK) button. Another dialog box PICTURE IMAGE ADJUSTMENT Menu will appear.
- 2 Press the POINT DOWN button and a red-arrow icon will appear. Move the arrow to the function that you want to select and then press SELECT (REAR CLICK) button.

Fine sync

Adjust the picture as necessary to eliminate flicker from the display. (From 0 to 127.)

Total dots

The number of the total dots in one horizontal period. Adjust the number to match your PC image.

White balance (Red / Green / Blue)

Move the arrow to the color that you want to adjust. Point to ▼ to lighten the color and select ▲ to deepen the color. (From 0 to 63.)

Contrast

Point to ▼ to decrease contrast, and select ▲ to increase contrast. (From 0 to 63.)

Brightness

Point to ▼ to adjust the image darker, and select ▲ to adjust brighter. (From 0 to 63.)

Sharpness

Point to ▼ to soften the image, and select ▲ to sharpen the image. (From 0 to 31.)

Each of the keys operates as follow.

- Reset** Recalls the data previously adjusted.
- Stored** Stores the adjusted data in the memory.
- Quit** Closes the PICTURE IMAGE ADJUSTMENT Menu.

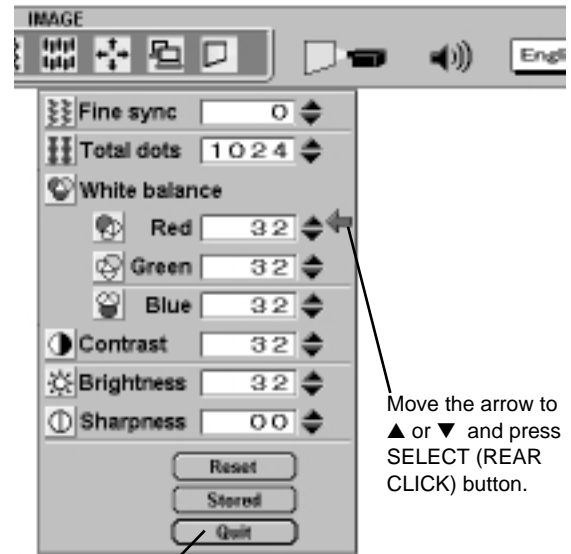

Close the PICTURE IMAGE ADJUSTMENT Menu.

NOTE : This menu cannot be operated when the incoming signal is digital or "RGB," "HDTV720p," "HDTV1035i" or "HDTV1080i" is selected on the SYSTEM MENU (P36 and 37).

NORMAL FUNCTION

The normal picture level is preset on this projector at the factory and can be restored anytime you press the NORMAL button (located on the Top Control or on the Remote Control Unit). The "Normal" display will be displayed on the screen for a few seconds.

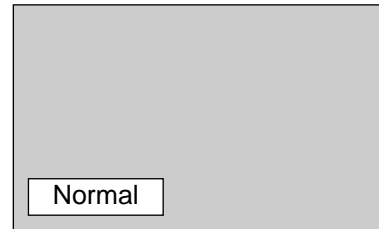

AUTO IMAGE ADJUSTMENT

The Auto Image adjustment is provided to automatically adjust Fine sync., Total dots, and Picture Position for most computers.

- 1 Press the MENU button and the ON-SCREEN MENU will appear. Press the POINT LEFT/RIGHT buttons to select AUTO IMAGE and press the SELECT (REAR CLICK) button. Another dialog box AUTO IMAGE Menu will appear.
- 2 Move the arrow to an item that you want to adjust by pressing the POINT UP/DOWN button. Change the setting On or Off by pressing the SELECT (REAR CLICK) button.

Fine sync

Adjust the picture as necessary to eliminate flicker from the display. This item can be adjusted manually. (Refer to page 40.)

Total dots

The number of the total dots in one horizontal period. This item can be adjusted manually. (Refer to page 40.)

Position

Adjustment of the position of the image. This item can be adjusted manually. (Refer to page 42.)

- 3 Move the arrow to "Go!" and press the SELECT (REAR CLICK) button to start the Auto Image adjustment. This adjustment can be executed by pressing AUTO IMAGE button on the Projector or on the Remote Control Unit.

Stored Stores the On/Off setting of each item.

Go! Starts the Auto Image Adjustment.

Quit Closes the AUTO IMAGE ADJUSTMENT Menu.

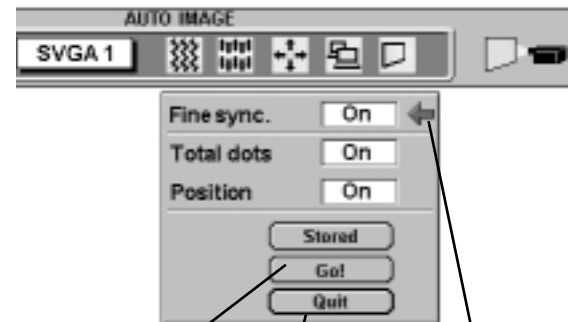

Starts the adjustment on the item set to "On".

Move the arrow to the item and then press the SELECT (REAR CLICK) button.

Terminates the PICTURE IMAGE ADJUSTMENT Menu.

NOTE : This menu cannot be operated when the incoming signal is digital or "RGB," "HDTV720p," "HDTV1035i" or "HDTV1080i" is selected on the SYSTEM MENU (P36 and 37).

The Fine sync., Total dots, and Picture Position of some computers may not be fully adjusted with the Auto Image Adjustment. In that case, manual adjustment is required to make fine image. (Refer to page 40 to adjust "Fine sync." or "Total dots" and page 42 to adjust Picture Position.)

PICTURE POSITION ADJUSTMENT

The position of the image can be adjusted vertically and horizontally through PICTURE POSITION ADJUSTMENT.

- 1** Press the MENU button and the ON-SCREEN MENU will appear. Press the POINT LEFT/RIGHT buttons to select POSITION and press the SELECT (REAR CLICK) button. The PICTURE POSITION dialog box will appear.
- 2** Select the arrow to the direction (described as ←, →, ↑ or ↓) that you want to adjust by pressing the POINT UP/DOWN/LEFT/RIGHT buttons, and then press the SELECT (REAR CLICK) button.

Each of the keys operates as follow.

Reset Recalls the setting data previously set.

Stored Stores the setting data in the memory.

Quit Closes the PICTURE POSITION Menu.



PICTURE SCREEN ADJUSTMENT

This projector has a picture screen resize function, which enables you to display the desirable image size.

- 1 Press the MENU button and the ON-SCREEN MENU will appear. Press the POINT LEFT/RIGHT buttons to select SCREEN and press the SELECT (REAR CLICK) button. Another dialog box PICTURE SCREEN Menu will appear.
- 2 Press the POINT DOWN button and a red-arrow icon will appear. Move the arrow to the function that you want to select and then press SELECT (REAR CLICK) button.

True

To make the image into its original size, select True in the dialog box. When the original image size is larger than the screen size (1280 x 1024), the image can be panned by pressing the POINT UP/DOWN/LEFT/RIGHT buttons.

Digital Zoom

To adjust the image size or pan the image, select Digital zoom in the dialog box. The ON-SCREEN menu and SCREEN ADJUST menu disappears, and the magnifying glass icon and the message "D. Zoom" is displayed.

This projector also enters Digital Zoom mode by pressing the Select (REAR CLICK) and FRONT CLICK buttons on the Wireless Remote Control Unit.

Refer to the following for operation.

Expand function

To expand the image size, press the SELECT (REAR CLICK) button. The image is magnified by degrees.

Compress function

To compress the image size, press the FRONT CLICK button. The size of image is reduced by degrees.

Panning function

To pan the image, press the POINT UP/DOWN/LEFT/RIGHT buttons. Panning function can work only when the image is larger than the screen size.

To cancel Digital Zoom mode, press any button except SELECT (REAR CLICK), FRONT CLICK, or POINT button. To adjust the image to 1280 x 1024, press NORMAL button.

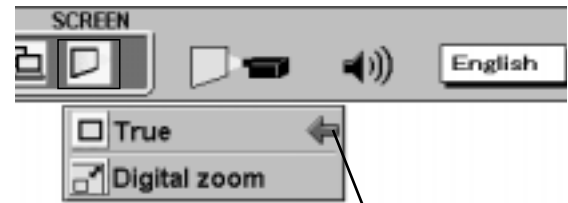

Move the arrow to the function and press the SELECT (REAR CLICK) button.

NOTE

- The True and the Digital Zoom cannot be operated when "RGB," "HDTV1035i" or "HDTV1080i" is selected on the SYSTEM MENU (P36 and 37).
- This projector cannot display any resolution higher than 1600 X 1200. If your computer's screen resolution is higher than 1600 X 1200, reset the resolution to the lower before connecting the projector.
- The image data in other than 1280 x 1024 is modified to fit the screen size in the initial mode.
- The normal "Panning Operation" may not function properly if the computer system prepared with the "PC Adjust" is used.

SELECTING VIDEO MODE

DIRECT OPERATION

Press the MODE button on the projector or the VIDEO button on the remote control unit to select Video 1, Video 2 Input.

The "Video 1", or "Video 2" display will appear on the screen for a few seconds.

MENU OPERATION

- 1 Press the MENU button and the ON-SCREEN MENU will appear. Press the POINT LEFT/RIGHT buttons to select Computer and press the SELECT (REAR CLICK) button. Another dialog box VIDEO MODE Menu will appear.
- 2 Press the POINT DOWN button and a red-arrow icon will appear. Move the arrow to the mode either Video 1 or Video 2, and then press the SELECT (REAR CLICK) button.

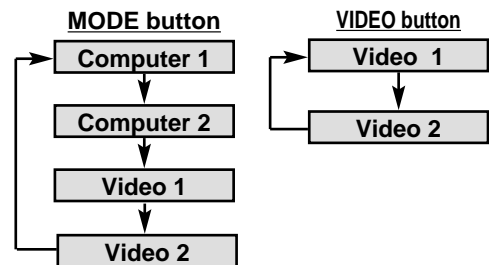

SELECTING VIDEO SOURCE

This projector automatically detects the signal from the VIDEO INPUT JACK(s) or the S-VIDEO INPUT JACK. When those jacks are connected at the same time, select the type of Video source in VIDEO SOURCE Menu.

- 1 Press the MENU button and the ON-SCREEN MENU will appear. Press the POINT LEFT/RIGHT buttons to select VIDEO SOURCE and press the SELECT (REAR CLICK) button. Another dialog box VIDEO SOURCE Menu will appear.
- 2 Press the POINT DOWN button and a red-arrow icon will appear. Move the arrow to the source that you want to select, and then press the SELECT (REAR CLICK) button.

This box indicates the Video source being selected.



Video When connect the composite video output from the video equipment to the VIDEO/Y jack, select "Video" in VIDEO SOURCE Menu.

Y, C When connect the separate Y/C video output from the video equipment to the VIDEO/Y and C jacks, select "Y,C" in VIDEO SOURCE Menu.

Y, Cb, Cr When connect the component video output from the video equipment to the VIDEO/Y, C/Cb (B-Y) and Cr (R-Y) jacks, select "Y, Cb, Cr" in VIDEO SOURCE Menu.

SELECTING COLOR SYSTEM

- 1 Press the MENU button and the ON-SCREEN MENU will appear. Press the POINT LEFT/RIGHT buttons to select SYSTEM and press the SELECT (REAR CLICK) button. Another dialog box VIDEO SYSTEM Menu will appear.
- 2 Press the POINT DOWN button and a red-arrow icon will appear. Move the arrow to "Auto", and then press the SELECT (REAR CLICK) button.

VIDEO SIGNAL FROM VIDEO JACK OR S-VIDEO JACK

Auto

The projector automatically detects the incoming Video system, and adjusts itself to optimize its performance. When the Video System is PAL-M or PAL-N, select the system manually.

PAL / SECAM / NTSC / NTSC4.43 / PAL-M / PAL-N

If the projector cannot reproduce the proper video image, it is necessary to select a specific broadcast signal format among PAL, SECAM, NTSC, NTSC 4.43, PAL-M, and PAL-N.

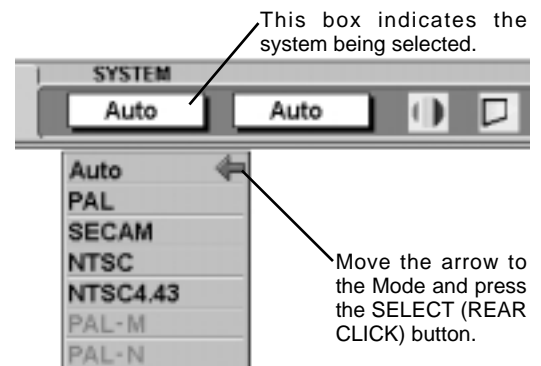

PICTURE IMAGE ADJUSTMENT

- 1 Press the MENU button and the ON-SCREEN MENU will appear. Press the POINT LEFT/RIGHT buttons to select IMAGE and press the SELECT (REAR CLICK) button. Another dialog box PICTURE IMAGE ADJUSTMENT Menu will appear.
- 2 Press the POINT DOWN button and a red-arrow icon will appear. Move the arrow to the function that you want to select and then press SELECT (REAR CLICK) button.

Color

Point to ▼ button to lighten the image, and select ▲ to deepen the image. (From 0 to 63.)

Tint

Point to ▼ button to increase purple, and select ▲ to increase green. (From 0 to 63.)

White balance (Red / Green / Blue)

Move the arrow to the color that you want to adjust. Point to ▼ to lighten the color and select ▲ to deepen the color. (From 0 to 63.)

Contrast

Point to ▼ button to decrease contrast, and select ▲ to increase contrast. (From 0 to 63.)

Brightness

Point to ▼ button to darken the image, and select ▲ to brighten the image. (From 0 to 63.)

Sharpness

Point to ▼ button to soften the image, and select ▲ to sharpen the image. (From 0 to 31.)

Each of the keys operates as follow.

Reset Recalls the data previously adjusted.

Stored Stores the data in the memory.

Quit Closes the PICTURE IMAGE ADJUSTMENT Menu.

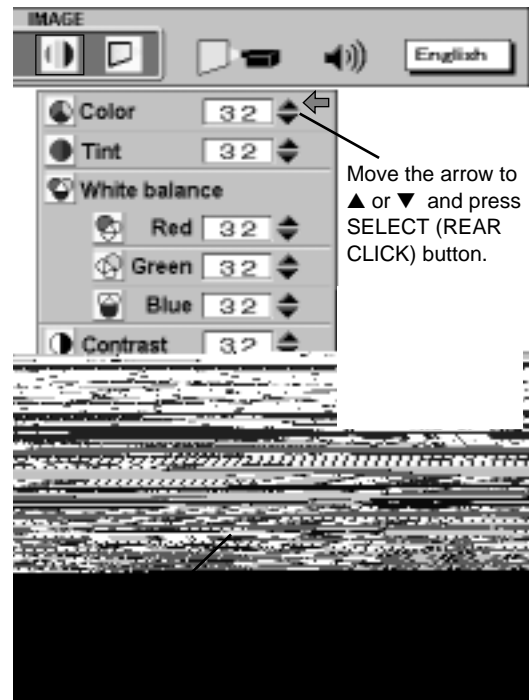

NORMAL FUNCTION

The normal picture level is preset on this projector at the factory and can be restored anytime you press the NORMAL button (located on the Top Control or on the Remote Control Unit). The "Normal" display will be displayed on the screen for a few seconds.

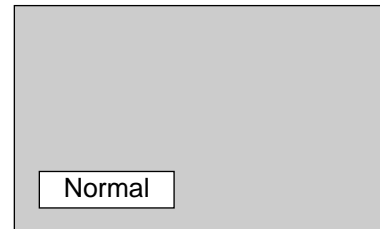

PICTURE SCREEN ADJUSTMENT

This projector has a picture screen resize function, which enables you to display the desirable image size.

- 1** Press the MENU button and the ON-SCREEN MENU will appear. Press the POINT LEFT/RIGHT buttons to select SCREEN and press the SELECT (REAR CLICK) button. Another dialog box PICTURE SCREEN ADJUSTMENT DISPLAY will appear.
- 2** Press the POINT DOWN button and a red-arrow icon will appear. Move the arrow to the screen size that you want to set, and then press the SELECT (REAR CLICK) button.

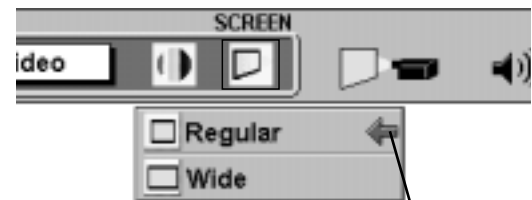

Move the pointer to the function and press the SELECT (REAR CLICK) button.

Regular

Normal Video Image size with 4 x 3 aspect ratio.

Wide

Resizes the image for wide screen size with 16 x 9 aspect ratio.

SETTING MENU

- 1 Press the MENU button and the ON-SCREEN MENU will appear. Press the POINT LEFT/RIGHT buttons to select SETTING and press the SELECT (REAR CLICK) button. Another dialog box SETTING Menu will appear.
- 2 Press the POINT DOWN button and a red-arrow icon will appear. Move the arrow to the item that you want to set, and then press the SELECT (REAR CLICK) button to set it "On" or "Off" or press the POINT LEFT/RIGHT button to adjust the value.

Blue back

When this function is "On," this projector will produce a blue image instead of the video noise on the screen when the input source is unplugged or turned off.

Display

This function decides whether to display the On-Screen Displays.

On ... shows all the On-Screen Displays.

Off sets the On-Screen Displays disappeared except;

- ON SCREEN MENU
- "Power off?" message
- P-TIMER

Reverse T/B

When this function is "On," the top / bottom reversed picture is provided to project the image from a ceiling mounted projector.

Reverse L/R

When this function is "On," the left / right reversed picture is provided to project the image to a rear projection screen.

Split wipe

Turn this function "On" in the SETTING menu. The picture will change into next one by sliding black image side ways like drawing the black curtains when the input source is turned into another one.

Power management

This function turns the Projection Lamp off when the projector detects signal interruption and the projector is not used for a certain period in order to reduce power consumption and maintain the Lamp-life. (This projector is shipped with this function ON.)

Power Management function operates to turn the Projection Lamp off when the input signal is interrupted and the projector is not operated over 5 minutes. This function operates as follows;

1. When the signal is interrupted, "No signal" and the counting down (5 minutes) display appears.
2. When the Projection Lamp turned off, the READY indicator turns off. The Cooling Fans operate for 90 seconds after the Projection Lamp is turned off. (During this "Cooling Down" period, the Lamp cannot be turned on.)
3. When the Lamp has cooled down, the READY indicator flashes and the Lamp can be turned on again (Power Management mode).

In this Power Management mode, the Projection Lamp is automatically turned on when the input signal connected or the projector is operated with any button on the Top Control or on the Remote Control.



Set the Pointer to the item and press the SELECT (REAR CLICK) button.

Reverse T/B function

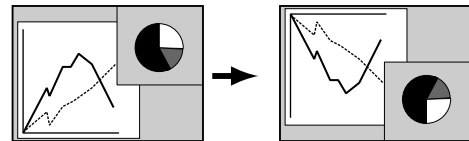

Reverse L/R function

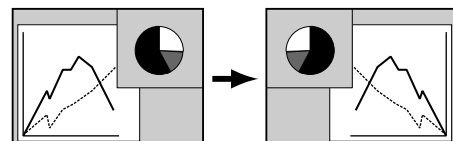

No signal
4 : 50

Time left until Lamp off.

USB

This Projector is equipped with USB port for interactive operation between the projector and the computer. Set the mode following steps below.

Wireless Mouse mode

Select "  " when controlling the computer with the Remote Control of this projector.

Projector mode

Select "  " when controlling the projector with the computer.

NOTE: Before you control the projector by computer, install USB driver (optionally sold parts) and set up the computer following instruction in the USB driver package. Contact your authorized dealer.

Remote control

This projector has two different remote transmit codes; the factory-set normal code (Mode 1) and the secondary code (Mode 2). This switching function prevents the remote control operation mixture (jam) when operating several projectors or video equipment together.

When operating the projector in "Mode 2" both projector and Remote Control must be switched to "Mode 2".

To change the code of the projector;

Set the Remote control in the SETTING menu to "Mode 2".

To change the code of the Remote Control;

Press both the MENU and the NORMAL buttons on the Remote Control together for over 10 seconds.

After changing the code, make sure the Remote Control operates properly.

To return to the normal code (Mode 1), operate both projector and Remote Control in the ways above again.

Lamp replacement monitor timer

Be sure to reset the Lamp Replacement Monitor Timer when the Lamp Assembly is replaced. When the Lamp Replacement Monitor Timer is reset, the LAMP REPLACEMENT indicator stops lighting.

- 1** Turn the projector on, and press the MENU button and the ON-SCREEN MENU will appear. Press the POINT LEFT/RIGHT buttons to select SETTING and press the SELECT (REAR CLICK) button. Another dialog box SETTING MENU will appear.
- 2** Press the POINT DOWN button and a red-arrow icon will appear. Move the arrow to "Lamp age" and then press the SELECT (REAR CLICK) button.
- 3** Move the arrow to replaced lamp number and then press the SELECT (REAR CLICK) button. The message "Lamp replace monitor Reset?" is displayed.
- 4** Select [Yes] to reset the Timer.

NOTE; Do not reset the Lamp Replacement Monitor Timer, except after the lamp is replaced.

**SELECTING LANGUAGE**

The language used in the ON-SCREEN MENU is selectable from among English, German, French, Italian, Spanish and Japanese.

- 1** Press the MENU button and the ON-SCREEN MENU will appear. Press POINT LEFT/RIGHT buttons to select LANGUAGE and press the SELECT (REAR CLICK) button. Another dialog box LANGUAGE Menu will appear.
- 2** Press the POINT DOWN button and a red-arrow icon will appear. Move the arrow to the language that you want to set, and then press the SELECT (REAR CLICK) button.



Move the Pointer to the language that you want to set, and then press the SELECT (REAR CLICK) button.

OPERATING WIRELESS MOUSE

The Wireless Remote Control Unit is not only able to operate the projector but also usable as a wireless mouse for most Personal Computers. The POINT buttons and the two CLICK buttons are used for the wireless mouse operation.

The wireless mouse is available only when PC mouse pointer is displayed on the screen. When the menu or the indicator of the projector is displayed on the screen instead of the PC mouse pointer, the wireless mouse cannot be used.

INSTALLATION

To use the Wireless Remote Control Unit as the Wireless Mouse for a Personal Computer, installation of the mouse driver (not supplied) is required. Make sure that the mouse driver is properly installed in your computer. And make sure that the mouse port of the computer connected to Control Port is activated.

- 1 Connect the mouse port of your computer to the Control Port of the projector with the Control Cable. (Refer to page 15 to 20 for connection.)
- 2 Turn the projector on first, and then turn on your computer. When the computer is switched on first, the Wireless Mouse may not work properly.

Note: When the computer has no mouse port, connect the Serial Port of the computer to Control Port of the projector with the Control Cable for Serial Port.

USING USB TERMINAL

USB Terminal can be also used as control port for wireless mouse operation. Connect the USB terminal of the computer to USB terminal of this projector with the USB cable (not supplied). In this operation, selecting Wireless Mouse Mode on SETTING Menu is required. (Refer to P49).

OPERATING WIRELESS MOUSE

When controlling the pointer of the computer, operate the Wireless Mouse with POINT button, SELECT (REAR CLICK) button, and FRONT CLICK button on the Wireless Remote Control Unit.

POINT button

Used to move the pointer. The pointer is moved corresponding with the direction you are pressing.

SELECT (REAR CLICK) button

This button has the same function as the left button in a PC mouse.

FRONT CLICK button

This button has the same function as the right button in a PC mouse. Pressing this button does not affect any operation when in Menu mode.

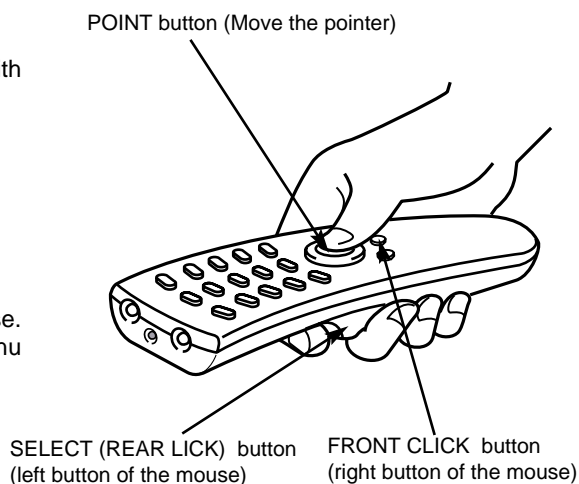

MAINTENANCE

TEMPERATURE WARNING INDICATOR

The TEMPERATURE WARNING INDICATOR flashes red when the internal temperature of the projector exceeds the normal temperature.

Possible causes for the temperature warning may be :

1. Ventilation slots of the projector are blocked. In such an event, reposition the projector so that ventilation slots are not obstructed.
2. Air filter is clogged with dust particles. Remove dust from the air filter by following instructions in the Air Filter Care and Cleaning section below.
3. If temperature warning indicator remains on after performing the checks listed above, cooling fan/internal circuits may be malfunctioning. Request service from an authorized dealer or service station.

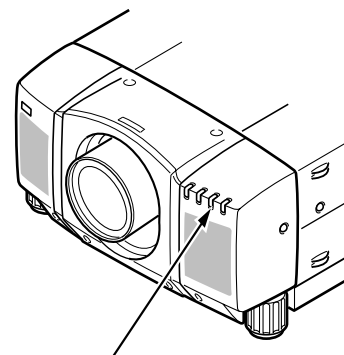

TEMPERATURE
WARNING
INDICATOR

AIR FILTER CARE AND CLEANING

The removable air filter prevents dust from accumulating on the surface of the projection lens and projection mirror. Should the air filter become clogged with dust particles, it will reduce the cooling fan's effectiveness and may result in internal heat build up and reduce the life of the projector.

To clean the air filter, follow the cleaning procedures below:

1. Turn the POWER ON/OFF button OFF.
2. Remove the air filter cover.
3. Remove the air filter and sponge from the filter cover.
4. Clean the air filter with a vacuum cleaner.
5. Replace the air filter and sponge. Make sure that air filter cover is fully inserted.



Do not clean with water. Doing so may damage the air filter.
Do not operate the projector with air filter removed.

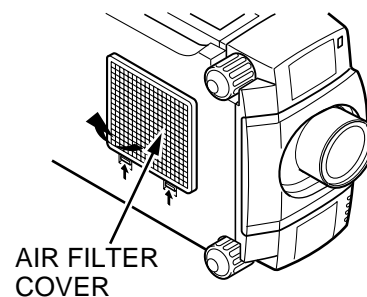

AIR FILTER
COVER

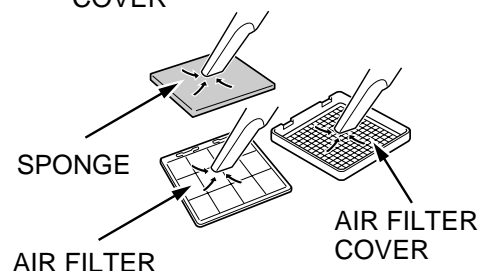

SPONGE

AIR FILTER

AIR FILTER
COVER

RECOMMENDATION

TO ENJOY PICTURE IMAGE, USE THE PROJECTOR IN THE CLEAN ENVIRONMENT. USAGE IN THE CLEAN ENVIRONMENT IS RECOMMENDED.

When used under the dusty or smoky conditions, dust may accumulate on the liquid crystal panel and lens inside it, and may resultantly be projected on the screen together with the picture.

When the above symptoms are noticed contact the place where your authorized dealer or service station for the cleaning.

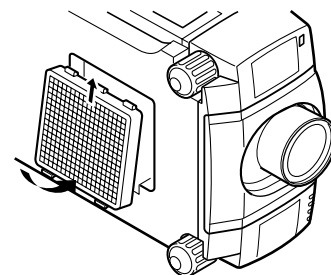

LAMP REPLACEMENT

WHEN THE PROJECTION LAMP OF THIS PROJECTOR DRAWS TO AN END, THE LAMP REPLACEMENT INDICATOR LIGHTS YELLOW AND THE WARNING MESSAGE "LAMP REPLACEMENT" APPEARS AS THE RIGHT FIGURE. WHEN THE WARNING MESSAGE IS DISPLAYED, THE PROJECTION LAMP SHOULD BE REPLACED.

To terminate the warning message.

Replace the Projection Lamp and reset the LAMP REPLACEMENT MONITOR TIMER (See "LAMP REPLACEMENT MONITOR TIMER" section on page 49.), and the warning message is terminated.

To erase the warning message in a moment.

To erase the warning message for a moment, move the arrow to "YES" by pressing the POINT UP/DOWN BUTTON(S) and then press the SELECT (REAR CLICK) BUTTON. This procedure is temporary measure, and the warning message appears again when the projector is turned on next time.

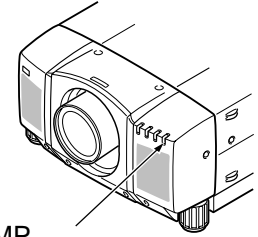

LAMP
REPLACEMENT
INDICATOR

LAMP REPLACEMENT



- For continued safety, replace with a lamp assembly of the same type.
- Allow the projector to cool for at least 45 minutes before you open the lamp cover. The inside of the projector can become very hot.
- Do not drop the lamp module or touch the glass bulb ! The glass can shatter and cause injury.

Follow these steps to replace the lamp assembly.

1. Turn off the projector and allow the projector to cool thoroughly.
2. Disconnect the AC cord from the projector.
3. Remove 2 screws with a screwdriver and remove the lamp cover.
4. Remove 2 screws with a screwdriver and pull out the lamp assembly by grasping the handle.
5. Replace the lamp assembly.
6. Tighten 4 screws to secure the lamp cover to the lamp assembly.
7. Connect the detachable AC cord to the projector.
8. Reset the lamp replacement monitor timer.

(See "LAMP REPLACEMENT MONITOR TIMER" section on page 49.)

NOTE: Do not reset the LAMP REPLACEMENT MONITOR TIMER, except after the lamp is replaced.

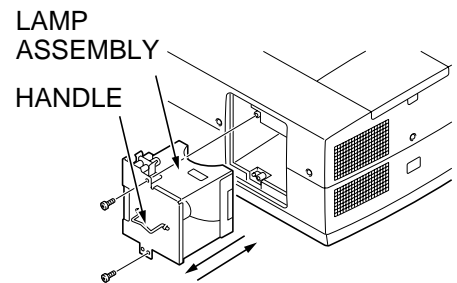
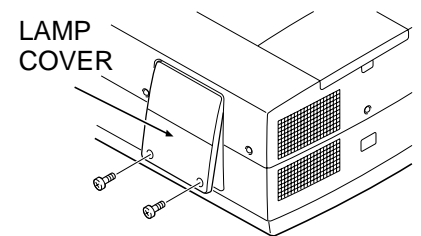

ORDER REPLACEMENT LAMP

Replacement Lamp can be ordered through your dealer. When ordering the Lamp, give the following information to the dealer.

- Model No. of your projector : PLC-EF12N/PLC-EF12NL/PLC-EF12E/PLC-EF12EL/PLC-EF12B/PLC-EF12BL
- Replacement Lamp Type No. : POA-LMP26

(Service Parts No. 610 285 7450)

CLEANING THE PROJECTION LENS

Follow these steps to clean the projection lens:

1. Apply a non-abrasive camera lens cleaner to a soft, dry cleaning cloth.
Avoid using an excessive amount of cleaner.
Abrasive cleaners, solvents or other harsh chemicals might scratch the lens.
2. Lightly wipe the cleaning cloth over the lens.
3. When you don't use the projector, replace the lens cover.

TROUBLESHOOTING

Before calling your dealer or service station for assistance, check the matters below once again.

1. Make sure you have connected the projector to your equipment as described in section "CONNECTING THE PROJECTOR" on pages 11 ~ 22.
2. Check cable connections. Verify that all computer, video and power cords are properly connected.
3. Verify that power is switched on.
4. If the projector still does not display an image, re-start the computer.
5. If the image still does not display, unplug the projector from the computer and check the computer monitor's display. The problem may be with your graphics controller rather than with the projector. (When you reconnect the projector, remember to turn the computer and monitor off before you power up the projector. Power the equipment back up in order of: Projector and computer)
6. If the problem still exists, check the following chart.

| Problem: | Try these Solutions: |
|-------------------------------|---|
| No power. | <ul style="list-style-type: none"> ● Plug the projector into an AC outlet. ● Turn the MAIN ON/OFF switch to ON. ● Press the POWER ON/OFF switch to ON. ● Be sure the READY INDICATOR light is ON. ● Wait 90 seconds after the projector is turned OFF before turning the projector back on. <p>NOTE: After pressing the POWER ON/OFF button to OFF. The projector functions as indicated.</p> <ol style="list-style-type: none"> 1. The LAMP POWER indicator will light and the READY indicator will turn off. 2. After 90 seconds, the READY indicator will light green again and the projector may be turned on by pressing the POWER ON/OFF button. <ul style="list-style-type: none"> ● Check temperature warning indicator. If the indicator flashes red, the projector cannot be turned on. (See "BASIC OPERATION" section on page 32). ● Check the projection lamp. ● Replace the lamp cover. (Check the interlock switch inside of the lamp cover.) |
| Image is out of focus. | <ul style="list-style-type: none"> ● Adjust the focus. ● Make sure the projection screen is at least 4.9' (1.5 m) from the projector. ● Check the projection lens to see if it needs cleaning. <p>NOTE: Moving the projector from a cool temperature location to a warm temperature location may result in moisture condensation on the lens. In such an event, leave the projector OFF and wait until condensation disappears.</p> |

| Problem: | Try these Solutions: |
|--|--|
| Picture is T/B inverted. | Check Reverse T/B feature. (See "SETTING" section on pages 48 ~ 49). |
| Picture is L/R Reversed. | Check Reverse L/R feature. (See "SETTING" section on pages 48 ~ 49). |
| Some displays are not seen during the operation. | Check Display feature. (See "SETTING" section on pages 48 ~ 49). |
| No sound. | <ul style="list-style-type: none"> ● Check audio cable connection from audio input source. ● Adjust audio source. ● Press the VOLUME (+) button. ● Press the MUTE button. |
| Remote control unit doesn't work. | <ul style="list-style-type: none"> ● Check the batteries. ● Make sure nothing is blocking between the remote control sensor and remote control unit. ● Make sure you are not too far from the projector when using the remote control unit. {Maximum operate range 16.4' (5 m)}. ● Check the transmitted signal mode from the remote control unit. (See "SETTING" section on pages 48 ~ 49). |
| Wireless mouse function does not work. | <ul style="list-style-type: none"> ● Check the cable connection between the projector and the computer. ● Check the mouse setting on your computer. ● Turn on the projector before you turn on the computer. |

SERVICE

WARNING: High voltages are used to operate this projector. Do not attempt to open the cabinet.

You can often correct operating problems yourself. If the projector fails to work properly, see "TROUBLESHOOTING" section on page 53, 54. To correct the failure, try the "Solutions".

If after following all operating instructions, you find that service is necessary, contact the Sanyo Service Station or the store where you purchased the unit.

Give the model number and explain the difficulty. We will advise you how to obtain service.



This symbol on the nameplate means the product is Listed by Underwriters Laboratories Inc. It is designed and manufactured to meet rigid U.L. safety standards against risk of fire, casualty and electrical hazards.



The CE Mark is a Directive conformity mark of the European Community (EC).

TECHNICAL SPECIFICATIONS

| | |
|---|---|
| Projector Type | Multi-media Projector |
| Dimensions (W x H x D) | 15.4" (390 mm) x 9.6" (245 mm) x 23" (585 mm) |
| Net Weight | 39.2 lbs (17.8 kg) |
| LCD Panel System | 1.8" TFT Active Matrix type x 3 panels |
| Number of Pixels | 3,932,160 {1,310,720 (1,280 x 1,024) x 3} |
| Color System | 6 color system (PAL, SECAM, NTSC, NTSC4.43, PAL-M and PAL-N) |
| Scanning Frequency | H-sync. 15 ~ 100 KHz, V-sync. 50 ~ 120 Hz |
| Projection Image Size (Diagonal) | Adjustable from 40" to 600" |
| Horizontal Resolution | 800 TV lines |
| Projection Lens | F2.0 ~ 2.3 lens with f=75.7 mm ~ 97.5 mm Motor zoom and focus |
| Motorized Lens Shift | ± 760 mm on 100" screen |
| Throw Distance | 4.9' (1.5 m) ~ 80.7' (24.6 m) |
| Projection Lamp | 440 watt type |
| AV Input Jacks | BNC Type {Video/Y, C/Cb (B-Y), Cr (R-Y)} x 2 sets, RCA Type (Audio R and L) x 2 sets and DIN 4 pin (S-Video) x 2 sets |
| Video Monitor Output Jack | BNC Type {Video/Y, C/Cb (B-Y), Cr (R-Y)} x 1 set and DIN 4 pin (S-Video) x 1 set |
| Audio Monitor Output Jacks | RCA Type (R and L) x 1 set |
| Computer Input 1 Jack | MDR 20-pin Terminal (Digital), HDB 15-pin Terminal (Analog), Multi-pole 12-pin (Control port) and USB port |
| Computer Input 2 Jack | BNC Type (R, G, B, H and V), Multi-pole 12-pin (Control port) and USB port |
| Computer Audio Input Jack | RCA Type (R and L) x 2 sets |
| Computer Output Jack | HDB 15-pin Terminal |
| Computer Audio Output Jack | RCA Type (R and L) x 1 set |
| Other Jack | Wired Remote Jack and Serial port (DB 9) |
| Built-in Speaker | INT. SP. Stereo (R and L), 3 watt RMS (T.H.D.10%) |
| Image Elevation Adjustment | Up to 4° |
| Voltage and Power Consumption | AC 100 ~ 120 V (7.8A Max. Ampere), 50/60 Hz (The U.S.A and Canada) AC 200 ~ 240 V (3.6A Max. Ampere), 50/60 Hz (Continental Europe and The U.K.) |
| Operating Temperature | 41°F ~ 95°F (5°C ~ 35°C) |
| Storage Temperature | 14°F ~ 140°F (-10°C ~ 60°C) |
| Remote Control Transmitters | Wireless Remote Control with Laser Beam (Class II Laser) Max. Output 1mW/Wave Length 660 ± 20nm, batteries (2) AA type. Wireless/Wired Remote Control, batteries (2) AA type. |

● The specifications are subject to change without notice.

Printed in Japan
Part No. 610 289 9474 (1AA6P1P2638-- P6VAC)



SANYO Electric Co., Ltd

Free Manuals Download Website

<http://myh66.com>

<http://usermanuals.us>

<http://www.somanuals.com>

<http://www.4manuals.cc>

<http://www.manual-lib.com>

<http://www.404manual.com>

<http://www.luxmanual.com>

<http://aubethermostatmanual.com>

Golf course search by state

<http://golfingnear.com>

Email search by domain

<http://emailbydomain.com>

Auto manuals search

<http://auto.somanuals.com>

TV manuals search

<http://tv.somanuals.com>