

ECJ-5205SN (5-Cup)  
ECJ-5210SN (10-Cup)

INSTRUCTION MANUAL

使用説明書

사용설명서

Deluxe Electric Rice Cooker/ Warmer

高級電飯保溫鍋

디럭스전기밥솥

HOUSEHOLD USE ONLY

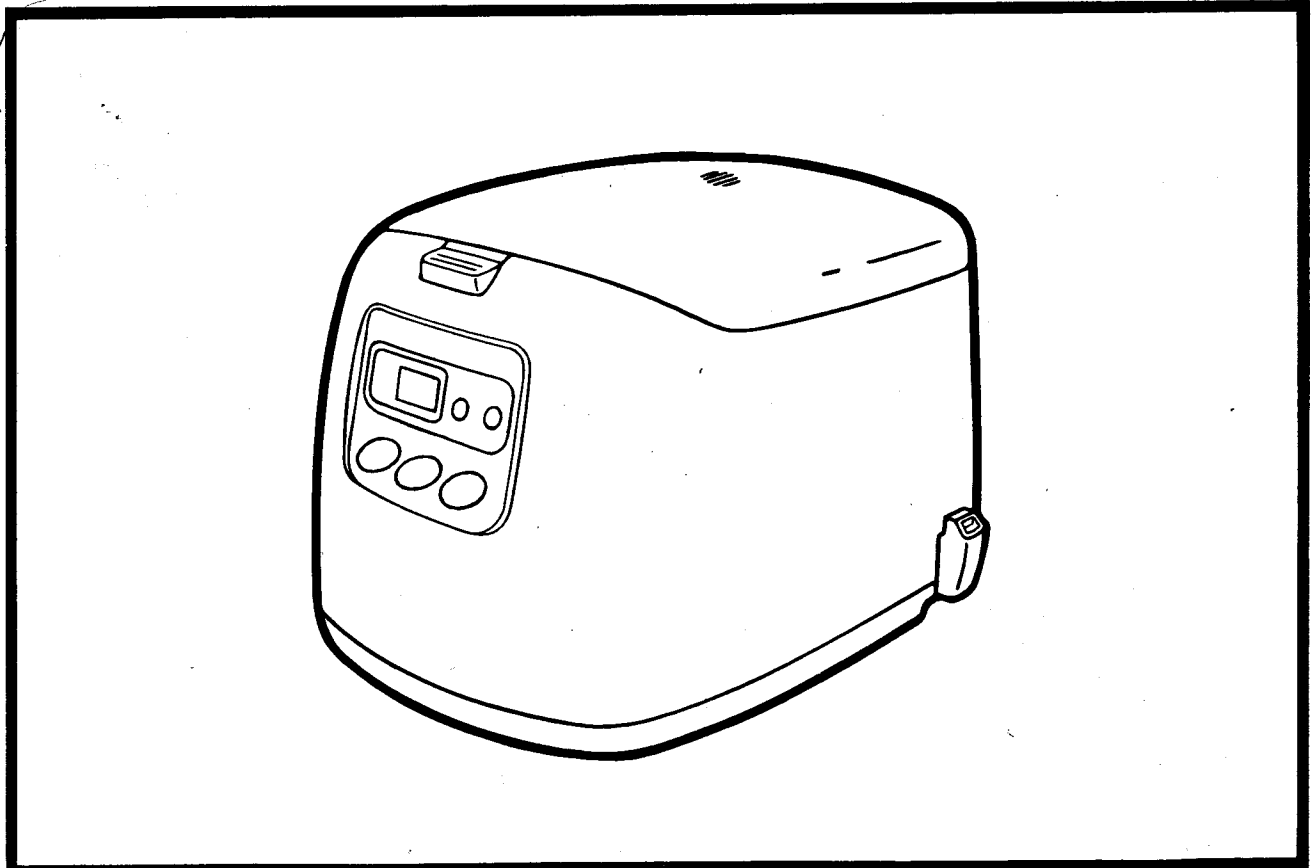

# IMPORTANT SAFEGUARDS

When using electrical appliances, follow basic safety precautions to reduce the risk of fire, electrical shock, and/or injury:

1. Read all instructions.
2. Do not touch hot surfaces. Use handles or knobs.
3. To protect against electrical shock, do not place cord, plugs, or appliance in water or other liquid.
4. Close supervision is necessary when any appliance is used by or near children.
5. Unplug unit from outlet when not in use and before cleaning.  
Allow to cool before putting on or taking off parts, and before cleaning the appliance.
6. Do not operate any appliance with a damaged cord or plug, after the appliance malfunctions, or has been damaged any manner.  
Return appliance to an authorized service facility for examination, repair, or adjustment.
7. Only use accessories approved for use with this unit to avoid injury.
8. Do not use outdoors.
9. Do not let cord hang over edge of table or counter, or touch hot surfaces.
10. Do not place on or near a hot gas or electric burner, or in a heated oven.
11. Extreme caution must be used when moving an appliance containing hot oil or other liquids.
12. To disconnect, turn all controls to the "OFF" position and remove plug from wall outlet.
13. Do not use appliance for other than intended use.

## SAVE THESE INSTRUCTIONS

---

### NOTE

---

- A. A short power-supply cord is provided to reduce the risks of becoming entangled in or tripping over a longer cord.
- B. Extension cords are available and may be used if care is exercised in their use.
- C. If extension cord is used:
- (1) the marked electrical rating of the extension cord should be at least as great as the electrical rating of the appliance,  
and
  - (2) the longer cord should be arranged so that it will not drape over the countertop or tabletop where it can be pulled on by children or tripped over.

---

This appliance has a polarized plug (one blade is wider than the other). As a safety feature, this plug will fit in a polarized outlet only one way. If the plug does not fit fully in the outlet, reverse the plug. If it still does not fit, contact a qualified electrician. Do not attempt to override this safety feature.

Thank you for your purchase of a Sanyo Electric Rice Cooker/Warmer.  
Please read these instructions carefully before use and be sure to keep the manual in a safe place for future reference.

謝謝您購買微型電腦電飯鍋。

在使用之前請您先仔細閱讀此使用說明書，閱後請小心保藏，以備日後方便閱。

구입해 주셔서 대단히 감사합니다.

이 사용설명서를 잘 읽은후, 바르게 사용바랍니다. 다 읽은후에는 소중히 보관하여 주십시오.

## Contents

See pages 3 to 10 for English instructions.

PRECAUTIONS.....	3
NAMES AND FUNCTIONS OF PARTS.....	4
OPERATING INSTRUCTIONS.....	5
HOW TO COOK WITH THE TIMER.....	6
MULTI-OPTION COOKING PROGRAMS.....	7
CARE AND MAINTENANCE.....	8
RECIPES.....	9~10
SPECIFICATIONS.....	27

## 목차

이 사용설명서는 19 페이지에서 26 페이지 까지가 한  
국어용입니다.

반드시 지켜주십시오.....	19
각 부분의명칭과취급방법.....	20
사용방법.....	21
타이머취반의방법.....	22
다기능취반의방법.....	23
손질방법.....	24
요리의페이지.....	25~26
사양.....	27

## 目錄

本使用說明書從11頁至18頁為中文。

注意事項.....	11
各部份的名稱及使用方法.....	12
使用方法.....	13
利用定時器煮飯方法.....	14
多功能煮飯方法.....	15
維護保養.....	16
各種飯烹製法.....	17~18
規格.....	27

# PRECAUTIONS

## Placement

Do not use the cooker in the following locations.

- Wet areas
- Unstable surfaces
- Near a gas burner
- Near where oil may spatter
- In direct sunlight

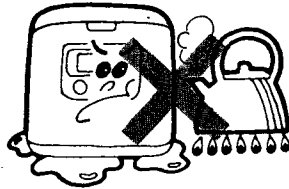

Watch out for Children

- Since the steam outlet becomes hot, and is dangerous, place the cooker out of reach of children when in use.

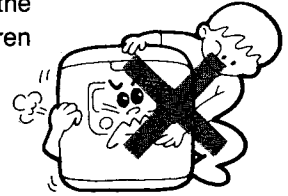

## Before Use

Plug the cooker into a Wall Outlet

- Use an AC outlet.

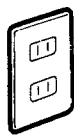

Wall Outlet

Do not use a multiple plug adapter !!

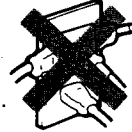

Do not use an extension cord.

Remove Extraneous Matter

- Before use, be certain to wipe away any grains of rice or water droplets clinging to the outer surface of the inner container or thermostat.

Inner container brim and bottom

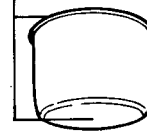

Thermostat

Heating plate

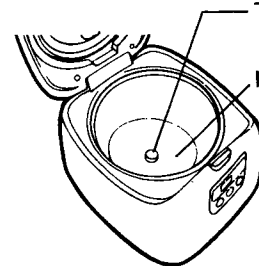

## During Use

While cooking, the cooker becomes very hot.

- Do not place hands or face near the outer lid or steam outlet.

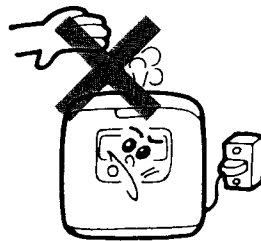

Never cover the cooker with a cloth while cooking.

- This may result in malfunction, or the outer lid warping or changing color.

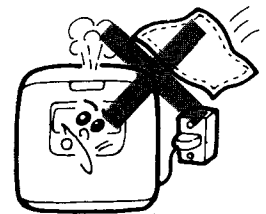

## After Use

Do not put anything into the main unit other than the inner container.

- Do not rinse out the main unit with water.

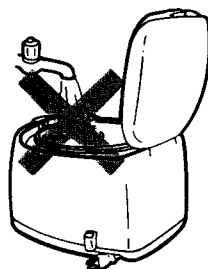

Be sure to handle the power cord with care.

- Hold the plug to remove it from the outlet.
- Do not place heavy objects on top of the cord, bend or pull the cord excessively, or splice it to other cords.
- Make sure that the cord does not touch other heating appliances.
- If the cord's covering becomes worn, damaged with cracks, or becomes too hot, contact your place of purchase.



# NAMES AND FUNCTIONS OF PARTS

## Names of Controls

Menu display

**TIMER SET Time**

During cooking [-] is displayed.

When steaming begins, the time until steaming is finished is displayed in units of one minute.

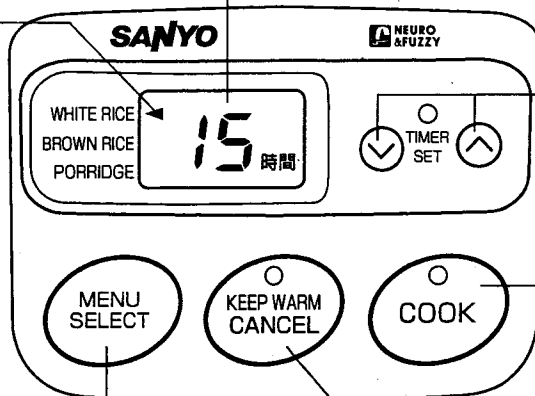

**TIMER SET Key**

- ⊖ advances the time rapidly in the backward direction.
- ⊕ advances the time rapidly in the forward direction.

**COOK key**

When using timer cooking, press this key after setting the time.

## Accessories

Spatula    Spatula holder

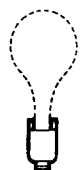

Measuring cup:  
Approx. 180 ml



**MENU SELECT key**

Before cooking, press this key to select the menu.

**KEEP WARM/CANCEL key**

Each time this key is pressed, the "CANCEL" and "KEEP WARM" functions are selected alternately.

The lamp lights up when "KEEP WARM" is selected.

## Main Body Part Names

**Hook button**

Press this to open the outer lid.

**Controls**

**Main body**

Outer lid

Inner container

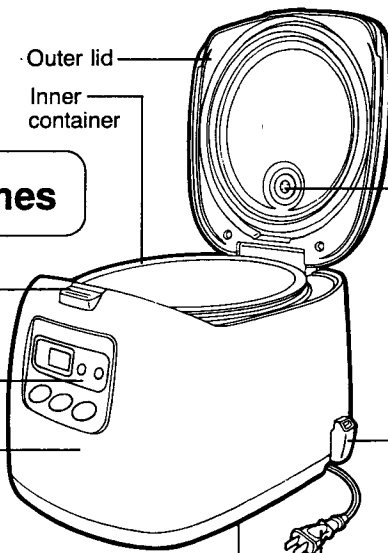

## Steam outlet

Steam cap

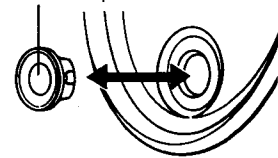

Press firmly in all the way.

## Spatula holder

### • Mounting

- ① Insert the indentation on the spatula holder into the projection on the body.
- ② Press the bottom of the spatula holder firmly into the body.

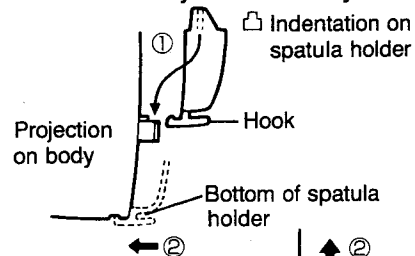

### • Removal

- ① Grasp the center of the spatula holder firmly to release the hook.
- ② Pull the holder up.

## Indent on main body

Place your hands here when lifting the cooker.

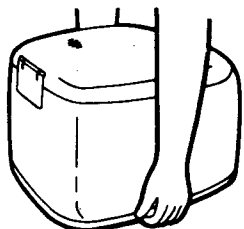

## Self-Retracting Power Cord

- Pull on the power plug to extend the cord. Do not extend the cord beyond the yellow tape.
- Give the cord a slight jerk and then release it. It will retract into the cooker by itself.

# OPERATING INSTRUCTIONS

## 1 Measure the rice and wash it briskly in a bowl.

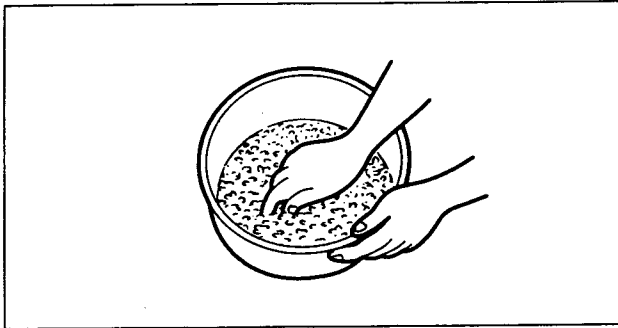

- The measuring cup supplied holds about 180 ml when filled level.

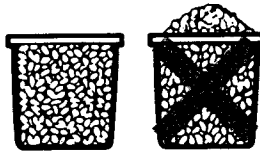

- Wash the rice briskly until the water turns clear. If rice is not adequately washed, it may cause sticking or a bad odor when being kept warm.

## 3 Plug in the cooker to cook.

Control key	
To cook normally ..... (WHITE RICE)	
To cook brown rice ..... (BROWN RICE)	 lamps light up and cooking starts.

## Display during cooking

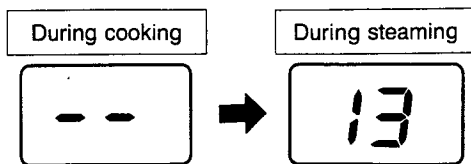

Steaming time is done 13 minutes before cooking finishes and displays the remaining time in 1 minute increments.

## 2 Measure the correct amount of water and put the inner container inside the main body.

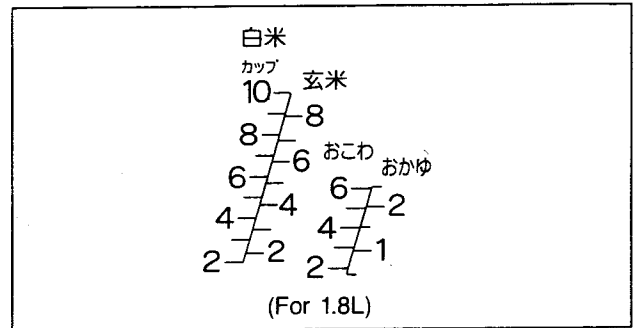

**Example** To cook six cups of rice, after putting in the rice, add enough water to reach the "6" water level marker for "白米".

- Adjust the water level to obtain the desired firmness of the cooked rice.
- Level off the rice.

## 4 When cooking is finished Stir up the rice and keep warm.

Keep warm display lamp	
Lights up	 Stir up the rice as quickly as possible. (Within 30 minutes after cooking.)
Lights up	

- Do not keep warm for more than 12 hours.

## After use

- Press the (KEEP/WARM CANCEL) key and then unplug the cooker.
- If you forget to press the (KEEP/WARM CANCEL) key, the cooker will go to keep warm as soon as you plug it in.

# HOW TO COOK WITH THE TIMER



The timer cannot be set when the KEEP WARM lamp is lit up.



Press the **KEEP WARM/CANCEL** key to turn off the KEEP WARM lamp.

**Example: Cooking program to be completed after seven hours.**

## 1 Select the desired menu

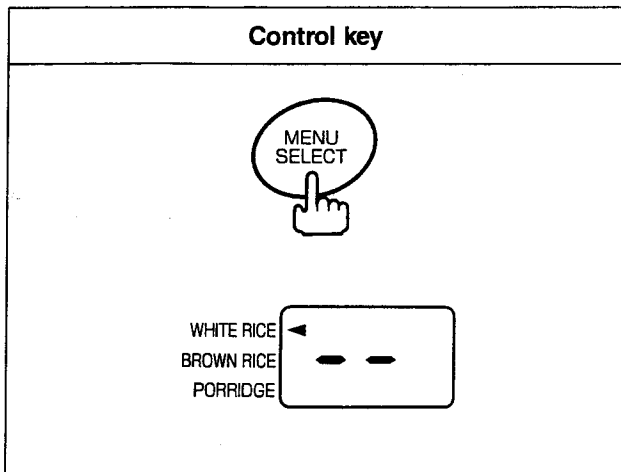

## 2 Set the timer to 7 using the **TIMER SET** key

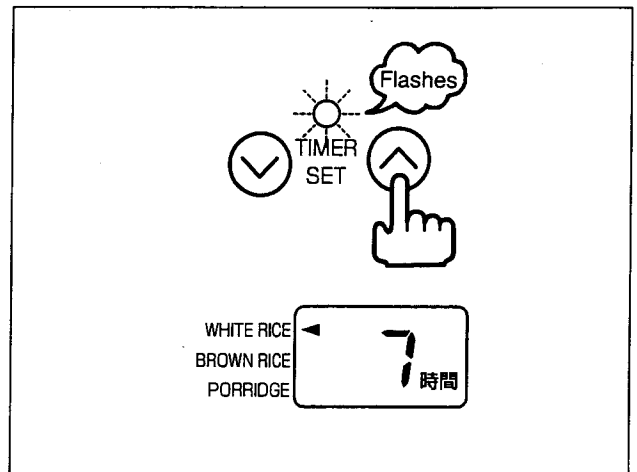

- Pressing advances the time, pressing makes the time go backwards. (Pressing and holding changes the time quickly.)

## 3 Press the **COOK** key

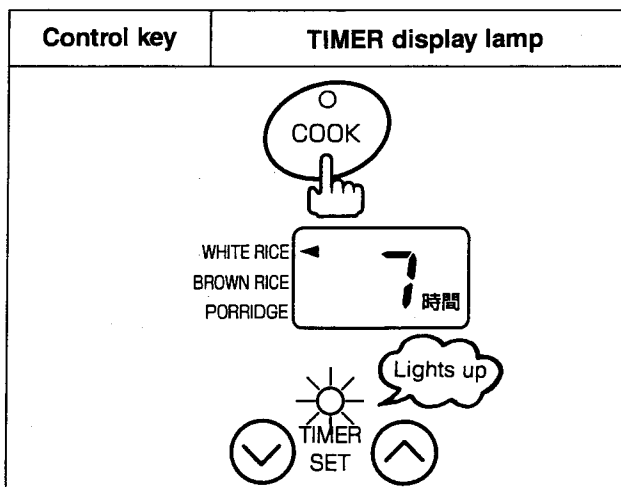

- The TIMER display lamp changes from flashing to fully lit up, and the rice will be ready in 7 hours time.

## Cooking begins

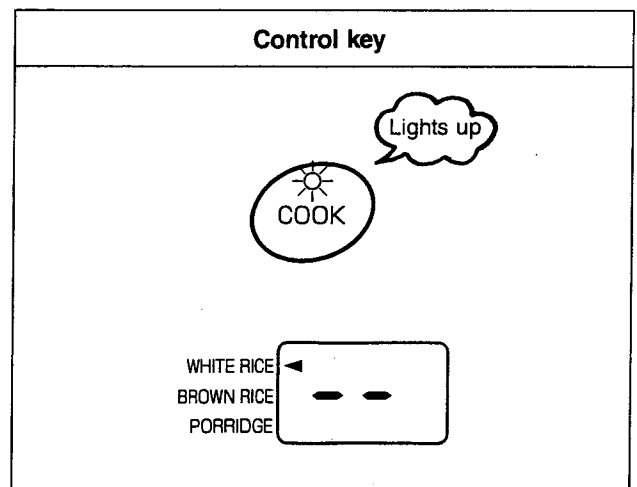

- When cooking starts, the TIMER display lamp goes out and the COOK lamp lights up.
- Cooking time is calculated on the basis of a full load of rice, so if the amount of rice is less, cooking may finish sooner. Also, cooking may take up to 10 minutes longer depending on water temperature and other factors.

# MULTI-OPTION COOKING PROGRAMS

## Changing the menu

MENU SELECT

Each time you press the MENU SELECT key, the ◀ mark moves and the menu changes.

Use this position for white rice, rice mixtures, or glutinous rice.  
\*This position will be displayed unless you select a different one.

Use this position for brown rice.

Use this position to cook rice porridge.

\*If you cook rice porridge with a position other than this one, it will boil over.

WHITE RICE

BROWN RICE

PORRIDGE

## Water amounts for each menu

### • Normal rice

Add water according to the [白米] water level index.

### • Porridge

#### Regular rice porridge

When cooking 1 cup of regular rice porridge, add water up to [1] on the [おかゆ] water level index.

### • Glutinous rice

Add water according to the [おこわ] water level index.

#### Half-porridge

Multiply the number of cups of rice by two and add water to this number on the [おかゆ] water level index. So, for 1 cup of rice, add water up to [2] on the [おかゆ] water level index.

## Cooking directions

### 1 Add water according to the menu.

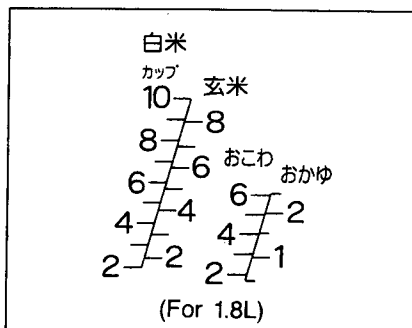

- Select the water level to suit the menu and amount of rice.

白米.....White rice, rice mixtures  
 玄米.....Brown rice  
 おこわ.....Glutinous rice  
 おかゆ.....Rice Porridge

### 2 Select the menu.

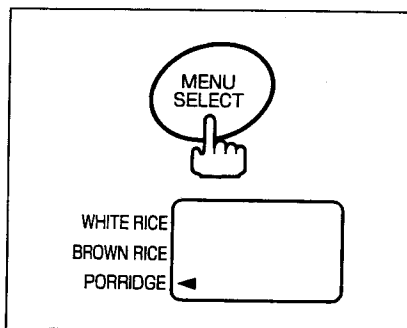

- Select the desired menu.
- If you select the wrong menu, the rice may boil over or not get cooked completely.

### 3 Cook

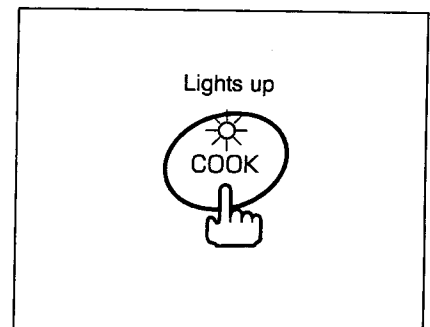

**Rice mixtures/Glutinous rice**...Eat as soon as possible, do not keep warm, as this may cause a bad odor or deterioration.  
**Rice porridge**.....Cannot be kept warm. Eat as soon as possible\* to prevent it from turning starchy.  
**The KEEP WARM lamp flashes.**



# CARE AND MAINTENANCE

Clean only after unplugging the unit and it cools off completely.

If dirt remains on the cooker, it may cause a bad odor during KEEP WARM, and affect the rice's taste. Be sure to clean the unit periodically.

- Do not use anything other than dishwashing detergent.

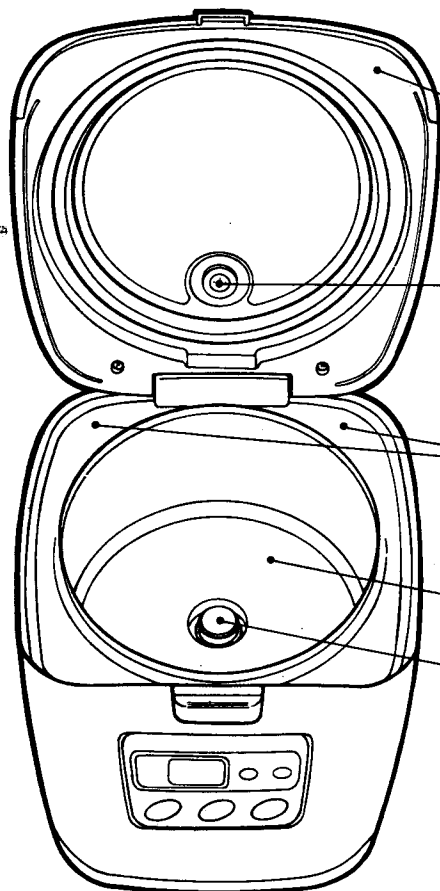
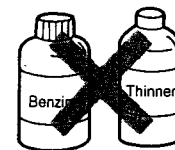

## Main body and outer lid

Wipe with a well-wrung cloth.

## Outer lid (inside)

If there is dried residue attached, wipe it off with a damp cloth.

## Steam cap

Remove and rinse in water. After cleaning, press it back firmly into place.

## Dew collector

Some water may collect here, so wipe it away.

## Heating plate

## Thermostat

If there is rice or dirt stuck on here, rice may become over- or undercooked.

Rub it lightly with number 320 sandpaper, and wipe it off with a well-wrung cloth.

## Inner container and spatula

Each time you cook, wash with neutral dishwashing detergent and a sponge or other soft item.

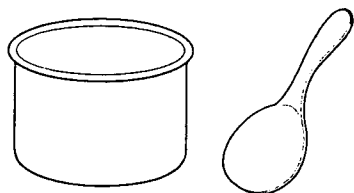

## Fluorine resin-coated inner container

### To prevent damage the fluorine resin-coated surface:

- Wash the rice in a separate container.
- Use only the included spatula.
- Do not put spoons or tableware into the container.
- Do not use vinegar.
- Wash the inner container soon after using spices.

\* Partial discoloring may occur after long-term use, this is normal and no cause for alarm.

# RECIPES PAGE

## Rice with Bamboo Shoots



Ingredients (4-6 servings)

Rice.....3 cups	Dashi (Japanese broth) .....	700ml
Boiled bamboo shoots .....	Light-colored soy sauce .....	2 tablespoons
.....200g	Sake .....	2 tablespoons
Chicken .....	Salt.....	Pinch
.....80g		
Kinome (Japanese pepper leaf buds) .....		
.....6-8 buds		

### Preparation

- 1 Wash the rice and let it sit for 30-60 minutes.
  - 2 Cut the boiled bamboo shoots up finely.
  - 3 Cut up the chicken in small pieces and parboil it.
  - 4 Make a seasoning by adding the soy sauce, sake and salt to the dashi, and mixing well.
  - 5 Drain the rice, put it into the inner container, and add enough of the seasoning prepared in step 4 to fill up to level 3 for white rice. Next, mix the ingredients of steps 2 and 3, and after making a hole in the center of the rice like a donut, put them in the center.
  - 6 Close the lid and select [WHITE RICE] with the [MENU] key, then press the [COOK] key.
  - 7 When the food is cooked, stir it, place it in a bowl, and garnish with the "kinome".
- \* Make the dashi with kombu (edible seaweed) and kezuribushi (Japanese dried fish shavings)

## Rice and Chestnuts.



Ingredients (4-6 servings)

Rice .....	3 cups
Chestnuts .....	30
Salt .....	1 teaspoon
Spinach.....	small amount

### Preparation

- 1 Wash the rice and let it sit for 30-60 minutes.
- 2 Remove the hard outer skin and inner skin from the chestnuts, and let them soak in water for about 30 minutes.
- 3 Drain the rice, put it into the inner container, and add the salt and enough water and to fill up to level 3 for "白米". Next, put the chestnuts on top.
- 4 Close the lid and select [WHITE RICE] with the [MENU] key, then press the [COOK] key.
- 5 Boil the spinach and put it in cold water, wring it out lightly and cut the stems to a length of about 1".
- 6 When the food is cooked, stir it, place it in a bowl, and garnish with the spinach from step 5.

## Rice with Red Beans



Ingredients (4-6 servings)

Mochi-gome (rice for making rice dumplings).....	2 cups
Uruchi-mai (nonglutinous rice) .....	1 cup
Red beans (azuki).....	45 g
Salt with parched sesame (gomashio).....	small amount

### Preparation

- 1 Mix the two kinds of rice together, wash and let sit for 30-60 minutes.
- 2 Put the red beans and plenty of water into a pot and heat over a strong flame. When it comes to the boil, discard the broth, add another half quart of water and simmer so that the beans are still a little hard.
- 3 When the red beans are boiled, separate the beans from the broth. Scoop the broth out with a ladle and let it drop back into the pot 4-5 times to air it.
- 4 Drain the rice and add it to the inner container. Add the broth from step 3 and add water up to [3] on the [おこわ] water level index. Place the red beans on top of the rice.
- 5 Close the lid and select [WHITE RICE] with the [MENU] key, then press the [COOK] key.
- 6 When the food is cooked, stir it, place it in a bowl and sprinkle with the salt with parched sesame.

## Brown Rice Pilaf

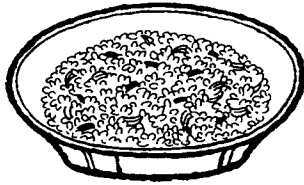

### Ingredients (4 servings)

Brown rice.....	3 cups	Chicken Consomme ...	4 cups
Onion .....	Small. 1/2	Salt .....	pinch
Carrot.....	80g	Butter .....	required
Sweet Corn .....	160g (whole kernel)		

### Preparation

- ① Wash the brown rice and drain.
- ② Remove the outer layers of the onion and chop. Peel the carrot and chop it into 1/4" pieces.
- ③ Empty the can of sweet corn, and strain.
- ④ Melt some butter in a frying pan and fry the chopped onion until it is tender, add the brown rice and fry for a short while.
- ⑤ Add the ingredients of step 4 to the inner container, add the 4 cups (800 ml) of chicken consomme into which the salt has been added, and place the carrot pieces and sweet corn on top.
- ⑥ Rplace the lid, press the **(MENU)** key to select "BROWN RICE" and press the **(COOK)** key.
- ⑦ When the food is cooked, mix thoroughly and serve it in the bowls.

## Crab Porridge

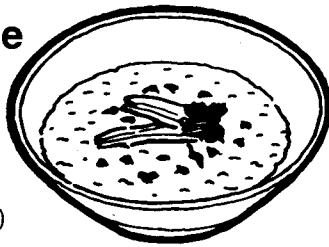

### Ingredients (4 servings) "Gobu" porridge-

Rice .....	1/2 cup
Crab legs (freshly boiled) .....	2 sides
Soup cubes .....	2
Saffron.....	0.2g
Lemon juice .....	small amount
Mitsuba (Trefoil, a Japanese aromatic plant leaf) .....	taste

### Preparation

- ① Wash the rice and let it sit for 30-60 minutes.
- ② Remove the crab meat from the shell and sprinkle on the lemon juice.
- ③ Simmer the crab shells, in water (500ml) with the soup cubes and saffron for about 30 minutes, then strain the liquid through a cloth.
- ④ Drain the rice, put it into the inner container, and add the soup from step ③ as the base of the "gobu" porridge to fill up to level 1 for "おかゆ".
- ⑤ Close the lid and select [PORRIDGE] with the **(MENU)** key, then press the **(COOK)** key.
- ⑥ Once it starts to steam, add to crab meat from step ②.
- ⑦ When the food is cooked, stir it, place it in a bowl, and garnish with chopped "mitsuba".

## NOTES

- Measure the rice using the cup included.
- After cooking rice with other ingredients, an odor will remain, so be sure to thoroughly wash the inner container and dew collector.
- Do not keep warm rice mixtures, pilaf, porridge or similar types of dishes.
- If seasonings such as soy sauce are put into the rice cooker, the rice can easily burn.
- The maximum capacity of rice cannot be cooked if it contains other ingredients.

In this case the maximum capacity is as follows:

ECJ-5205SN .....	3 cups
ECJ-5210SN .....	6 cups

- Many ingredients, and salt or other seasonings do not dissolve well and may collect at the bottom. In this case, cooking may not be done properly. To prevent this from happening, add less ingredients, or thoroughly mix the seasonings in 'dashi', soup, or water before adding them.
- Do not measure "dashi" or other seasonings with the included measuring cup.
- You can change the amount of water according to the variety of rice, the season, or to suit your taste.

# SPECIFICATIONS

Both models can be used in areas where the power line frequency is 50 Hz or 60 Hz.

Model No.		ECJ-5205SN	ECJ-5210SN
Power source		120V AC Only	
Power Consumption	Cooking	645 W	910 W
	Keep Warm	34 Wh	44 Wh
Cooking capacity	White rice	0.05 - 0.26gal (1 - 5.5 cups)	0.10 - 0.48gal (2 - 10 cups)
	Rice mixtures	0.05 - 0.14gal (1 - 3 cups)	0.10 - 0.29gal (2 - 6 cups)
	Brown rice	0.10 - 0.19gal (2 - 4 cups)	0.10 - 0.38gal (2 - 8 cups)
	Glutinous rice	0.05 - 0.14gal (1 - 3 cups)	0.10 - 0.29gal (2 - 6 cups)
	White rice porridge	0.02 - 0.07gal (0.5 - 1.5 cups)	0.02 - 0.12gal (0.5 - 2.5 cups)
Cord length		Approx. 4.5"	Approx. 3.1"
Dimensions (W x D x H)		9.8" x 12" x 9.1"	10.8" x 13.1" x 10.4"
Weight		Approx. 6.2 lbs	Approx. 7.9 lbs

\*The numbers when rice is being kept warm indicate the average amount of power consumed per hour to keep the rice warm (with an indoor temperature of 60 degrees Fahrenheit) at a stabilized temperature.

\*The amount of power consumed per hour in the "CANCEL" state is approximately 2 Wh.

## 規格

(不管是50Hz或60Hz頻率, 都能夠共同使用。)

型號		ECJ-5205SN	ECJ-5210SN
電源		120 伏交流電	
電力消耗	煮飯時	645W	910W
	保溫時	34Wh	44Wh
飯容量	白米	0.18-1.0 公升 (1-5.5 杯)	0.36-1.8 公升 (2-10 杯)
	燴飯	0.18-0.54 公升 (1-3 杯)	0.18-1.08 公升 (2-6 杯)
	糙米	0.36-0.72 公升 (2-4 杯)	0.36-1.44 公升 (2-8 杯)
	糯米飯	0.18-0.54 公升 (1-3 杯)	0.36-1.08 公升 (2-6 杯)
	粥	0.09-0.27 公升 (0.5-1.5 杯)	0.09-0.45 公升 (0.5-2.5 杯)
電源線長度		約 1.4m	約 0.95m
尺寸 (最闊×深×高)		248 × 305 × 230mm	274 × 333 × 265mm
重量		約 2.8 公斤	約 3.6 公斤

\* 保溫時的消耗電量表示穩定時每小時的平均保溫消耗電量。(室溫20℃時)

\* 於取消狀態時的每小時消耗電量約為2Wh。

## 사양

(50Hz, 60Hz의 주파수에 관계없이 공용으로 사용할 수 있습니다.)

제품번호		ECJ-5205SN	EJC - 5210SN
전원		120V AC 한정	
소비전력	취반시	645W	910W
	보온시	34Wh	44Wh
취반용량	흰 밥	0.18~1.0L (1 ~5.5컵)	0.36~1.8L (2~10컵)
	잡곡밥	1.18~0.54L (1 ~3컵)	0.36~1.08L (2 ~6컵)
	현미밥	0.36~0.72L (2 ~4컵)	0.36~1.44L (2 ~8컵)
	찰 밥	0.18~0.54L (1 ~3컵)	0.36~1.08L (2 ~6컵)
	죽	0.09~0.27L (0.5 ~1.5컵)	0.09~0.45L (0.5 ~2.5컵)
전선 길이		약 1.4m	약 0.95m
제품규격 (최대폭 × 길이 × 높이)		248 × 305 × 230mm	274 × 333 × 265mm
무게		약 2.8kg	약 3.6kg

\* 보온시의 소비전력은, 온도가 안정된 상태에서 1 시간당 평균보온 소비전력량입니다(온실 20℃인 경우).

\* 취소 상태에서 1 시간당의 소비전력량은 약 2Wh입니다.

# SANYO

SANYO FISHER Company  
21605 Plummer Street,  
Chatsworth, CA 91311, U.S.A.

SANYO CANADA Inc.  
50 Beth Neilson Drive,  
Toronto, Ontario M4H 1M6, Canada

Printed in Japan

## Free Manuals Download Website

<http://myh66.com>

<http://usermanuals.us>

<http://www.somanuals.com>

<http://www.4manuals.cc>

<http://www.manual-lib.com>

<http://www.404manual.com>

<http://www.luxmanual.com>

<http://aubethermostatmanual.com>

Golf course search by state

<http://golfingnear.com>

Email search by domain

<http://emailbydomain.com>

Auto manuals search

<http://auto.somanuals.com>

TV manuals search

<http://tv.somanuals.com>