

SAMSUNG



High Resolution Varifocal Dome Camera SID-70 User Guide

Before installing and operating this product,
please read this manual thoroughly.

Before operating the camera, confirm the camera model and correct input power voltage. To help you understand this manual thoroughly, we'll introduce our model description.

■ SID-70 SERIES

- NTSC MODEL
SID-70N
- PAL MODEL
SID-70P

■ MODEL DESCRIPTION

- SID-70X
└── SIGNAL SYSTEM

- SIGNAL SYSTEM
N → NTSC MODEL
P → PAL MODEL

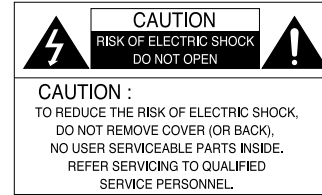

The lightning flash with an arrowhead symbol, within an equilateral triangle is intended to alert the user to the presence of uninsulated "dangerous voltage" within the product's enclosure that may be of sufficient magnitude to constitute a risk of electric shock to persons.



The exclamation point within an equilateral triangle is intended to alert the user to the presence of important operating and maintenance (servicing) instructions in the literature accompanying the appliance.

This equipment has been tested and found to comply with limits for a Class A digital device, pursuant to part 15 of the FCC Rules. These limits are designed to provide reasonable protection against harmful interference when the equipment is operated in a commercial environment. This equipment generates, uses, and can radiate radio frequency energy and, if not installed and used in accordance with the instruction manual, may cause harmful interference to radio communications.

Operation of this equipment in a residential area is likely to cause harmful interference in which case the user will be required to correct the interference at his own expense.

WARNING-Changes or modifications not expressly approved by the manufacturer could void the user's authority to operate the equipment.

WARNING-To prevent electric shock and risk of fire hazards:

- ◆ Do NOT use power sources other than that specified.
- ◆ Do NOT expose this appliance to rain or moisture.

This installation should be made by a qualified service person and should conform to all local codes.

- Features 5
- Precautions 7
- Components and Accessories 8
- Overview 9
- Installation 9
 - Installation 9
 - Adjust the panning, tilting and rotating while watching the monitor 12
- Connection 13
 - Connecting to Monitor 13
 - Connecting to Power 13
 - Using Coaxial Communications 14
- Operating your Camera 15
 - Menu Configuration 15
 - Menu Setup 16
 - LENS 17
 - EXPOSURE 17
 - WHITE BALANCE 19
 - SSDR 20
 - BACKLIGHT 21
 - SSNR3 23
 - DAY/NIGHT 24
 - SPECIAL 25
 - EXIT 30
- Troubleshooting 31
- Specification 32
- Dimension 33

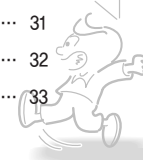

High Resolution

By adopting a diagonal 6mm(1/3") 410,000 (NTSC) pixel, 470,000(PAL) pixel SONY CCD, the camera produces clear picture quality with a horizontal resolution of 600 TV lines in color and a horizontal resolution of 700 TV lines in B/W mode.

Excellent Sensitivity

The built-in high sensitivity COLOR CCD produces a clear image.

- Color : 0.15Lux(50IRE, @F1.2), 0.0003LUX (SENS-UP, x512)
- B/W : 0.001Lux(50IRE, @F1.2), 0.000002LUX (SENS-UP, x512)

SSNR3 (Samsung Super Noise Reduction) Function

The high-performance W-V DSP chip effectively removes low-light gain noise and afterimage to provide clear images even in dark environments.

DAY&NIGHT (ICR)

This camera has a function that automatically selects the mode that is appropriate for daytime or night-time conditions.

The COLOR mode operates in daytime conditions to provide optimum colors, and B/W mode operates in night-time conditions to enhance the definition of the image.

Motion Detection

Since the camera detects motion without any additional external sensor, you can monitor activity more efficient.

SSDR (Samsung Super Dynamic Range)

For images with high contrast between bright and dark areas from difficult lighting conditions such as backlighting, this camera selectively illuminates darker areas while retaining the same light level for brighter areas to even out the overall brightness.

DIS (Digital Image Stabilizer)

The DIS function compensates for any camera movement, to produce more stable pictures.

Communication

Coaxial communication methods are supported.

- Protocol : Pelco Coaxitron

Miscellaneous Functions

HLC(High Light Compensation), SENS-UP, FLIP (H/V-REV), D-ZOOM, SHARPNESS and PRIVACY functions are provided.

OSD

The camera's OSD is complimented by 18 languages.

- NTSC : Korean, English, French, Spanish, Japanese, Portuguese, Taiwanese
- PAL : English, Chinese, German, Italian, French, Spanish, Russian, Czech, Polish, Romanian, Serbian, Swedish, Danish, Turkish, Portuguese



Samsung Techwin cares for the environment at all product manufacturing stages to preserve the environment, and is taking a number of steps to provide customers with more environment-friendly products. The Eco mark represents Samsung Techwin's will to create environment-friendly products, and indicates that the product satisfies the EU RoHS Directive.

Warnings & Cautions

This information is provided to ensure your safety and to prevent any losses, financial or otherwise. Please read it carefully and use the product accordingly.

* For product inquiries, please contact the retail shop where you bought the camera. The use of equipment such as an aerial ladder while providing after-sales service shall be at your expense.

* Separate the power plug during a thunder storm.

* This product is support equipment for surveillance system. Therefore, we can't compensate for material loss and/or personal injuries by robbery, fire, natural disaster or other such events.

Warning/Attention/Special Mark Messages



Ignoring this information may result in material loss and/or serious personal injuries including death.



Ignoring this information may result in material loss and/or a slight injuries.



Indicates "Never Allowed."



Indicates "No Disassembling."



Correct Disposal of This Product (Waste Electrical & Electronic Equipment)

(Applicable in the European Union and other European countries with separate collection systems)

This marking shown on the product or its literature, indicates that it should not be disposed with other household wastes at the end of its working life. To prevent possible harm to the environment or human health from uncontrolled waste disposal, please separate this from other types of wastes and recycle it responsibly to promote the sustainable reuse of material resources.

Household users should contact either the retailer where they purchased this product, or their local government office, for details of where and how they can take this item for environmentally safe recycling.

Business users should contact their supplier and check the terms and conditions of the purchase contract. This product should not be mixed with other commercial wastes for disposal.

Precautions

Do not install under extreme temperature conditions.



Use only under temperature conditions between -10°C and +50°C. Provide good ventilation when using in high temperature conditions.

Do not install in high humidity environment.



May lower image quality.

Do not install under unstable lighting conditions.



Severe lighting changes or flickering may hinder normal camera operation.

Avoid touching the camera lens.



The lens is the most important component of the camera. Be careful not to smear it with fingerprints.

Do not drop the camera or subject it to physical shock.



May cause a product malfunction.

Never keep the camera face to strong light directly.

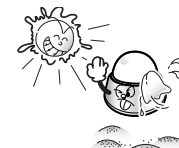

May damage the CCD.

Precautions

Do not expose the camera to radioactivity.



If exposed to radioactivity, the CCD will fail.

Do not expose the camera to rain or other types of liquids.



May cause a product malfunction. Wipe dry any liquids. Liquids may contain minerals that are corrosive to electronic components.

Notes

- Exposure to a spotlight or an object emitting strong light may cause smear or blooming.
- Ensure that the power source complies with normal specifications before supplying it to the camera.

Components and Accessories



- 1 SID-70
- 2 Instruction Manual
- 3 M4 Tapping Screw 3EA
- 4 Installation Video Output Cable

Overview

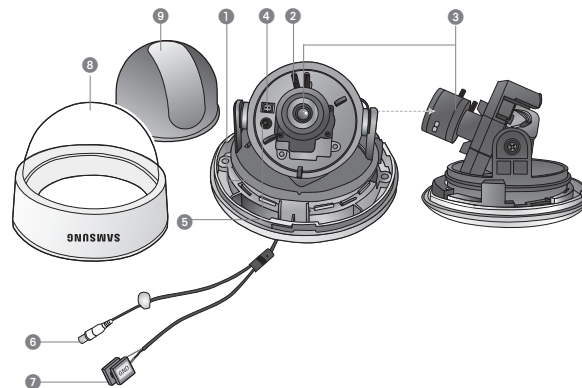

- 1 **Pan Base** : Control panning angle of camera.
- 2 **Rotate Base** : Control rotating angle of camera.
- 3 **x3.6 Vari-focal Lens Module 2.8 ~ 10.0mm (F1.2)**
- 4 **Video Output Terminal to Monitor**
- 5 **Function Setup switch** : Display the menu on the screen and move the cursor to four directions to confirm status or after changing a selected item.
- 6 **Video Output Jack**
- 7 **Power Input Terminal**
- 8 **Dome Cover**
- 9 **Shield Case**

Installation

Notes

- The installation should be done by qualified service personnel or system installers.
- If the ceiling material is not strong enough to hold the installation screws, the camera may fall off. Reinforce the ceiling as needed.

- 1) Separate the dome cover by turning anti-clockwise.
- 2) Separate the shield case by pulling from the camera body.

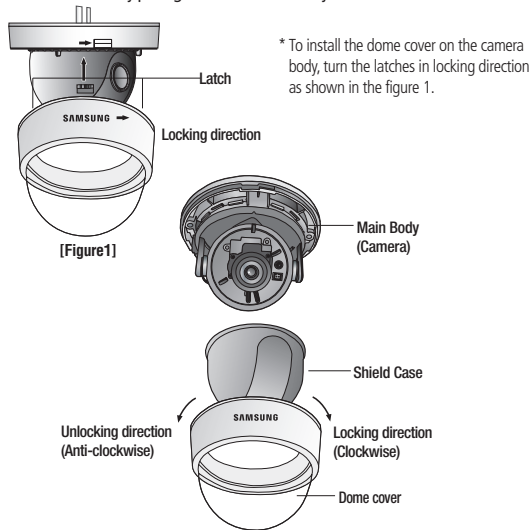

Notes

- The installation should be done by qualified service personnel or system installers.
- If the ceiling material is not strong enough to hold the installation screws, the camera may fall off. Reinforce the ceiling as needed.
- To change the position of the cable, take away the Hole Cover and pass the cable through.

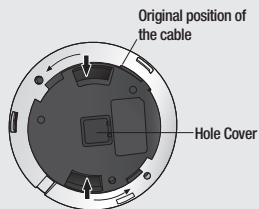

When using the Ceiling bracket

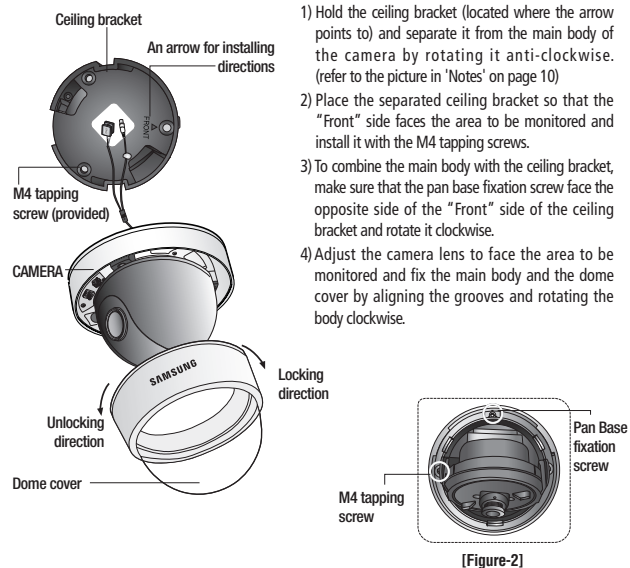

- 1) Hold the ceiling bracket (located where the arrow points to) and separate it from the main body of the camera by rotating it anti-clockwise. (refer to the picture in 'Notes' on page 10)
- 2) Place the separated ceiling bracket so that the "Front" side faces the area to be monitored and install it with the M4 tapping screws.
- 3) To combine the main body with the ceiling bracket, make sure that the pan base fixation screw face the opposite side of the "Front" side of the ceiling bracket and rotate it clockwise.
- 4) Adjust the camera lens to face the area to be monitored and fix the main body and the dome cover by aligning the grooves and rotating the body clockwise.

Notes

- If you want to install the camera with the ceiling bracket combined, fix it using two M4 tapping screws at the side of the main body (refer to the [Figure-2] on page 11).

Adjust the panning and tilting, rotating while watching the monitor

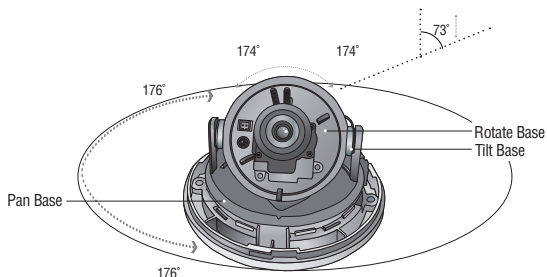

1) You can adjust camera to any direction by using Pan, Tilt, Rotate mechanism.

- Pan Base moves by 176° to each side direction and 352° on the whole.
- Tilt Base covers total 73° angle(0° ~ 73°).
- Rotate Base moves by 174° to each side direction and 348° on the whole.

2) Methods of adjustment

- The case of wall installation
 - 1 After mounting the camera on a wall, adjusting the panning angle so that the camera can face the direction to monitor when tilted.
 - 2 Adjust the tilting angle by rotating the tilt base.
 - 3 Loosen the rotate base hold screw and adjust rotate base for the best view.
 - 4 Tighten the rotate base hold screw.
- The case of ceiling installation
 - 1 After mounting the camera on a ceiling, adjusting the panning angle to the correct viewing position by rotating the pan base.
 - 2 Adjust the tilting angle by rotating the tilt base.
 - 3 Loosen the rotate base hold screw and adjust rotate base for the best view.
 - 4 Tighten the rotate base hold screw.

Connecting to Monitor

Connect the Video Output jack to the VIDEO-IN jack of monitor.

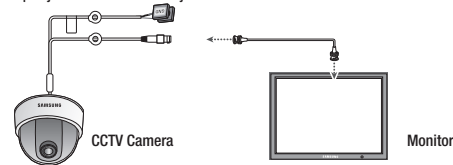

- As the connecting method varies with the instruments, refer to the manual supplied with the instrument.
- If necessary, you can connect the monitor to the REMOTE jack on the back of your camera.
- Only connect the cable when the power is turned off.

Connecting to Power

Connect the adaptor to the power input terminal as shown in the figure below. The recommended adaptor specification for SID-70N/SID-70P is DC 12V / 500mA or AC 24V / 300mA.

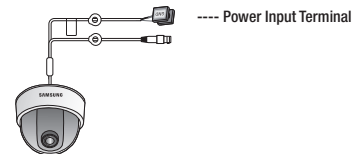

When the resistance value of copper wire is at [20°C(68°F)]

Copper wire size (AWG)	#24(0.22mm ²)	#22(0.33mm ²)	#20(0.52mm ²)	#18(0.83mm ²)
Resistance (Ω/m)	0.078	0.050	0.030	0.018
Voltage Drop (V/m)	0.028	0.018	0.011	0.006

- As shown in the table above, voltage decreases as the wire gets longer. Therefore use of an excessively long adaptor output line for connection to the camera may affect the performance of the camera.

*Standard voltage for camera operation : DC 12V ± 10%, AC 24V ± 10%

*There may be some deviation in voltage drop depending on the type of wire and the manufacturer.

Connection

Notes

- Be sure to connect power only after all the installation is complete.
- Note that AC / DC adaptor is not supplied with camera.
- Ground should be connected to the GND terminal.

Using Coaxial Communications

- Coaxial Communications System
- OSD Control method

CAMERA	DVR	CONTROLLER
SET	MENU/ENTER	OSD KEY
UP	UP KEY	JOYSTICK UP
DOWN	DOWN KEY	JOYSTICK DOWN
LEFT	LEFT KEY	JOYSTICK LEFT
RIGHT	RIGHT KEY	JOYSTICK RIGHT

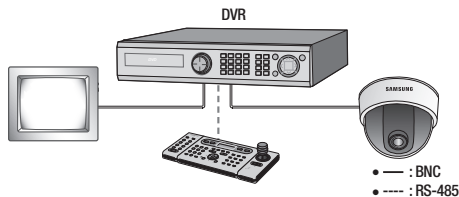

- Video Cable

The camera's video output port is connected to the monitor with a BNC coaxial cable, shown below : If the distance between the camera and the monitor exceeds the recommended maximum, please use an auxiliary video amp.

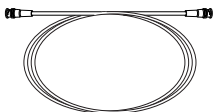

Distance	Recommended Cable Specification
300m	3C2V(RG-59/U)
450m	5C2V(RG-6/U)
600m	7C2V(RG-11/U)

Notes

- It is recommended that pure copper coax cable is used and not copper coated steel, as this will cause issues with the communication over the coaxial cable.

Operating Your Camera

Menu Configuration

MAIN SETUP			
LENS	● DC		
EXPOSURE	● BRIGHTNESS ● SENS-UP	● SHUTTER ● RETURN	● AGC
WHITE BAL	● ATW ● MANUAL	● OUTDOOR ● AWC→SET	● INDOOR
SSDR	● OFF	● ON	
BACKLIGHT	● OFF	● BLC	● HLC
SSNR3	● OFF	● ON	
DAY/NIGHT	● COLOR	● B/W	● AUTO
SPECIAL	● IMAGE ADJ ● SYNC ● DIS	● MONITOR ● MOTION DET ● LANGUAGE	● CAM TITLE ● PRIVACY ● RETURN
EXIT	● SAVE	● NOT SAVE	● RESET

Operating Your Camera

Menu Setup

Use the Function Setup switch within the camera.

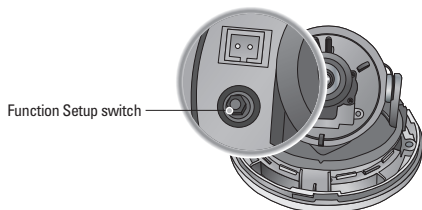

1. Press the Function Setup switch.

- Main setup menu is displayed on the monitor screen.

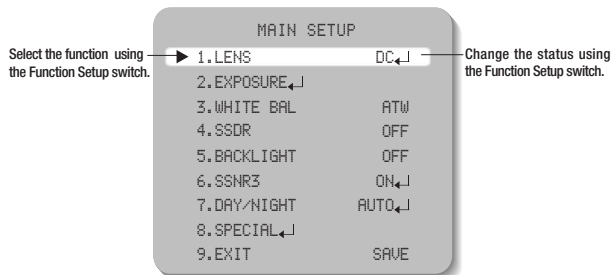

2. Select a desired function using the Function Setup switch.

- Place the cursor over a desired item.

3. Set up a selected item by using the Function Setup switch.

4. To finish the setting, select 'EXIT' and press the Function Setup switch.

Notes

- An item with the ◀↓ icon also has sub menus. To select a sub menu, select an item with the icon and press the Function Setup switch.
- An item with the - - - icon is unavailable due to function settings.

LENS

Using this function, you can control the screen brightness.

1. When the SETUP menu screen is displayed, select 'LENS' by using the Function Setup switch so that the arrow indicates 'LENS'.

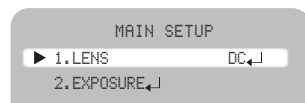

2. The Lens mode has sub menu site as listed below.

- BRIGHTNESS : Adjusts the video brightness.
- FOCUS ADJ : To adjust the lens focus correctly, you must activate the Focus Settings mode. To activate the Focus Settings mode, adjust the lens focus, and then deactivate the settings mode.
- You can adjust the shutter value of ESC shutter mode.

EXPOSURE

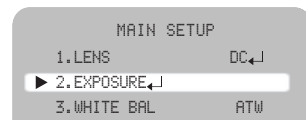

1. When the SETUP menu screen is displayed, select 'EXPOSURE' by using the Function Setup switch so that the arrow indicates 'EXPOSURE'.

2. Select a desired mode using the Function Setup switch.

- ◀ BRIGHTNESS : Adjusts the video brightness.

Operating Your Camera

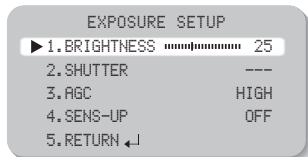

- SHUTTER : You can select the shutter.
 - A.FLK : Select this when you experience picture flicker, this happens when there is a clash with the installed lighting frequency.
 - ESC : Select this to control the shutter speed automatically. If ESC is selected, the shutter speed is automatically controlled depending on the ambient illumination of the subject.
 - MANUAL : You can control shutter speed manually.
(NTSC MODEL : 1/60~1/120,000, PAL MODEL : 1/50~1/120,000)
 - --- : Shutter speed is fixed at 1/60sec(1/50sec).

Notes

- Set the shutter mode to --- if color rolling occurs.
- When the SHUTTER is set to ESC after selecting the Internal Synchronization Type, the picture may become unstable if the camera faces a bright fluorescent light. Therefore, take care when choosing the installation position.
- When the SHUTTER is set to MANUAL or A.FLK mode, SENS-UP will be disabled.

- AGC(AUTO GAIN CONTROL) : The higher the gain level, the brighter the screen - but the greater the noise.
 - OFF : Deactivates the AGC function.
 - LOW : Allows automatic gain control from 5.3dB to 32dB.
 - HIGH : Allows automatic gain control from 5.3dB to 37dB.
- SENS-UP : When it is night or dark, the camera automatically detects the light level and maintains a clear picture if this mode is activated.
 - OFF : Deactivates the SENS-UP function.
 - AUTO : Activates the SENS-UP function.

Notes

- If you set the Function Setup switch to 'AUTO' mode, You can adjust the brightness by increasing or decreasing the shutter speed. (x2 ~ x512)
- Note that the higher the zoom level, the brighter the screen, but the more likely it is that an after-image will appear.
- Although Noise, Spots, and Whitish symptoms may occur in SENS-UP operation when the zoom level is increased, this is normal.

- RETURN : Select this to save the changes in the EXPOSURE menu and return to the SETUP menu.

White Bal (White Balance)

Use the White Balance function to adjust the screen color.

1. When the SETUP menu screen is displayed, select 'White Bal' by using the Function Setup switch so that the arrow indicates 'White Bal'.
2. Select a desired mode using the Function Setup switch.

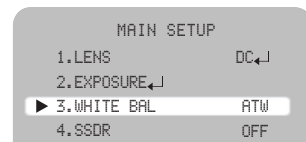

- ※ Select one of the following 5 modes, as appropriate for your purpose.
 - ATW : Select this when the color temperature is between 1,700°K and 11,000°K.
 - OUTDOOR : Select this when the color temperature is between 1,700°K and 11,000°K. (sodium light inclusion)
 - INDOOR : Select this when the color temperature is between 4,500°K and 8,500°K.
 - MANUAL : Select this to fine-tune White Balance manually. Set White Balance first by using the ATW or AWC mode. After that switch to MANUAL mode, fine-tune the White Balance and the Function Setup switch.

Operating Your Camera

- **AWC—SET** : To find the optimal luminance level for the current environment, point the camera towards a sheet of white paper and press the Function Setup switch. If the environment changes, readjust it.



Notes

- White Balance may not work properly under the following conditions. In this case select the AWC mode.
 - 1 When the color temperature of the environment surrounding the subject is out of the control range (e.g. clear sky or sunset).
 - 2 When the ambient illumination of the subject is dim.
 - 3 If the camera is directed towards a fluorescent light or is installed in a place where illumination changes dramatically, the White Balance operation may become unstable.

SSDR (Samsung Super Dynamic Range)

SSDR illuminates darker areas of an image while retaining the same light level for brighter areas to even out the overall brightness of images with high contrast between bright and dark areas.

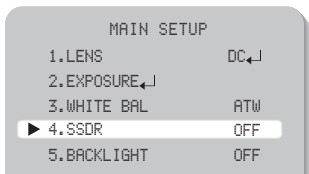

1. When the SETUP menu screen is displayed, select 'SSDR' by using the Function Setup switch so that the arrow indicates 'SSDR'.
2. Use the Function Setup switch to change the SSSDR level in the sub menu according to the contrast between bright and dark areas.

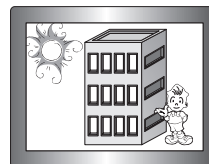

SSDR ON

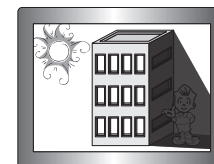

SSDR OFF

BACKLIGHT

Unlike conventional cameras, the SID-70 is designed so that it delivers a distinctive subject and background at the same time, even when the subject is in backlight, by adopting a function of the proprietary W-V DSP chip.

1. When the SETUP menu screen is displayed, select 'BACKLIGHT' by using the Function Setup switch so that the arrow indicates 'BACKLIGHT'.

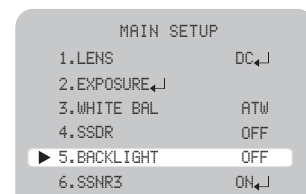

2. Select a desired mode using the Function Setup switch depending on the camera purpose.
 - **BLC** : Enables a user to select a desired area on a picture and view that area more clearly.
 - LEVEL : Adjust level of the BLC function.
 - TOP/BOTTOM/LEFT/RIGHT : Adjust the area to be enhanced.

Operating Your Camera

☉ HLC (High Light Compensation) :

If the scene contains extremely bright light areas such as; from car headlight, the light can mask out much of the on-screen detail.

- LEVEL : Adjust level of the HLC function.
- LIMIT : Enable to change the operating condition.
- MASK COLOR/TONE : Change the color / brightness of the masking area.
(Black, Red, Blue, Cyan, Magenta)
- TOP/BOTTOM/LEFT/RIGHT : Adjust the area to be enhanced.

☉ OFF : Not being used

3. Select a desired mode using the Function Setup switch.

☉ Select 'BLC' to adjust the area to be enhanced then adjust the level.

☉ HLC : Enable the user to change the level, limit, mask color/tone and area.

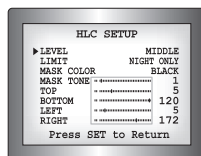
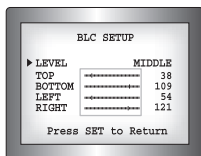

Notes

- Because there can be a difference in the effectiveness of HLC according to the amount of light area in the screen, optimize the installation angle for the best HLC performance.
- When dark, the HLC is only activated when a bright light exceeding a specific size. (In NIGHT ONLY mode.)
- The HLC is not activated in day light or when bright light is not present at night. (In NIGHT ONLY mode.)
- When HLC function is used, D-ZOOM and DIS functions are not activated.

SSNR3

This function reduces the background noise in a low luminance environment.

1. When the SETUP menu screen is displayed, select 'SSNR3' by using the Function Setup switch so that the arrow indicates 'SSNR3' .

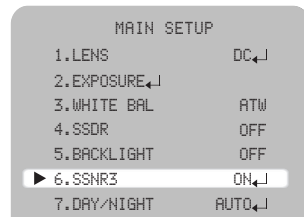

2. Select a desired mode using the Function Setup switch.

- ☉ OFF : Deactivates SSNR3. Noise is not reduced.
- ☉ ON : Activates SSNR3 so that noise is reduced.

3. Set the SSNR3 mode to 'ON' and press the Function Setup switch. Then you can adjust the noise reduction level.

Notes

- You cannot set the SSNR3 to 'ON' or 'OFF' when the AGC mode of the EXPOSURE menu is 'OFF'.
- When adjusting the noise reduction level in the SSNR3 mode, remember that the higher the level set, the more the noise level will be reduced, as will the brightness of the image.

Operating Your Camera

DAY/NIGHT

You can display pictures in color or in black and white.

- When the SETUP menu screen is displayed, select 'DAY/NIGHT' by using the Function Setup switch so that the arrow indicates 'DAY/NIGHT'.

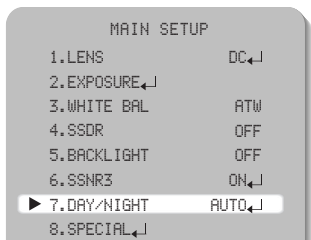

- Select a desired mode using the Function Setup switch according to the picture display you want.

- ☞ COLOR : The picture is always displayed in color.
- ☞ B/W : The picture is always displayed in black and white.
You can turn on or off the burst signal on B/W mode.
- ☞ AUTO : The mode is switched to 'Color' in a normal environment, but switches to 'B/W' mode when ambient illumination is low. To set up the switching time for AUTO mode, press the Function Setup switch.
You can turn on or off the burst signal on B/W mode.

- DURATION : You can select the day/night switching point.

- DWELL TIME : You can select the duration time about changing the day/night mode.
→ 3s, 5s, 7s, 10s, 15s, 20s, 30s, 40, 60s

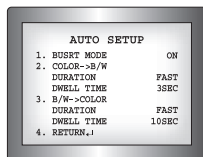

	Color → B/W	B/W → Color
Early	2.5 lux	5 lux
Late	1 lux	10 lux

* The day/night switching point of the camera can be adjusted.



Notes

- When AGC in the EXPOSURE menu is 'OFF', '----' mode operates as selecting 'COLOR' mode and 'AUTO' mode cannot be selected.

SPECIAL

- When the SETUP menu screen is displayed, select 'SPECIAL' by using the Function Setup switch so that the arrow indicates 'SPECIAL'.

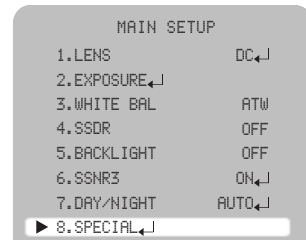

Operating Your Camera

2. Select a desired mode using the Function Setup switch.

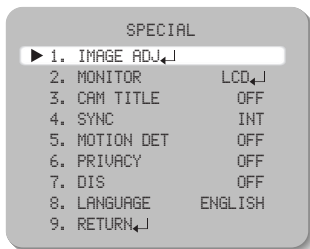

☞ IMAGE ADJ :

- 1) When the SPECIAL menu screen is displayed, select 'IMAGE ADJ' by using the Function Setup switch so that the arrow indicates 'IMAGE ADJ'.
- 2) Select a desired mode using the Function Setup switch.

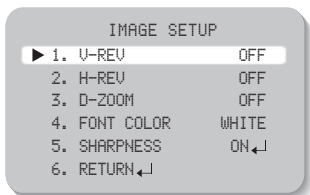

- V-REV : You can flip the picture vertically on the screen.
- H-REV : You can flip the picture horizontally on the screen.
- D-ZOOM : You can use a digital zoom of x1 ~ x16.
- FONT COLOR : You can change the OSD font color. (White, Yellow, Green, Red, Blue)

- SHARPNESS : As you increase this value, the picture outline becomes stronger and clearer. Adjust this value appropriately depending on the sharpness of the picture.
- RETURN : Select this to save the settings for the IMAGE ADJ menu and to return to the SPECIAL menu.



Notes

- When the V-REV or H-REV mode is enabled, the text on the screen does not flip.
- If you increase the SHARPNESS level too high, the picture may become distorted or noise may appear.

☞ Monitor : Please change the settings value of video appropriate to your monitor.

- LCD : Please select this menu item when using an LCD monitor.
You can change the gamma, PED level and color gain in the sub menus.
- CRT : Please select this menu item when using a CRT monitor.
- USER : Please use this menu item when using a monitor other than standard ones. You can change the gamma, PED level, and color gain in the sub menus.

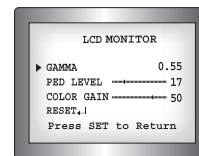

☞ CAM TITLE : If you enter a title, the title will appear on the monitor.

- 1) If the SPECIAL menu screen is displayed, use the Function Setup switch so that the arrow indicates 'CAM TITLE'.
- 2) Set it to 'ON' by using the Function Setup switch.
- 3) Press the Function Setup switch.
- 4) Use the Function Setup switch to move to a desired letter and select the letter by pressing the Function Setup switch. Repeat this to enter multiple letters. You can enter up to 15 letters.

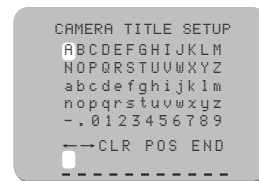

Operating Your Camera

- 5) Enter a title, move the cursor to 'POS' and press the Function Setup switch. The entered title appears on the screen. Select the position to display the title on the screen by using the Function Setup switch and press the Function Setup switch. When the position is determined, select 'END' and press the Function Setup switch to return to the SPECIAL menu.



Notes

- When the CAM TITLE menu is 'OFF', no title will be displayed on the monitor screen even if you enter one.
- Only English is available in this mode.
- If you move the cursor to CLR and press the Function Setup switch, all the letters are deleted. To edit a letter, change the cursor to the bottom left arrow and press the Function Setup switch. Move the cursor over the letter to be edited, move the cursor to the letter to be inserted and then press the Function Setup switch.

- SYNC : In areas where the supply is at 60Hz(NTSC), 50Hz(PAL), you can synchronize the output phase of multiple cameras using the power synchronization function (Line-Lock) without using a synchronization signal generator.



- INT : Internal Synchronization Type
- L/L : Power Synchronization Type, Line-lock

- Press the Function Setup switch.
- You can select a desired phase from 0 to 359 when select 'phase'.

Notes

- When using AC power at 60Hz(NTSC), 50Hz(PAL) frequency, you can use the L/L type synchronization.
- When the power is DC 12V, the SYNC menu is fixed to the 'INT' mode.

➤ MOTION DET :

This product has a feature that allows you to observe movement of objects in 8 different areas on the screen, and the words 'MOTION DETECTED' appear on the screen when movement is detected. You can monitor activity more efficient.

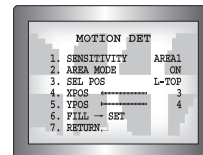

- 1) When the SPECIAL menu screen is displayed, press the Function Setup switch so that the arrow indicates 'MOTION DET'.

- 2) Set up the mode using the Function Setup switch.

- SENSITIVITY : You can select up to 8 MD areas. When SENSITIVITY number is high, motion detection sensitivity is increased to recognize even small movement.
- AREA MODE : Determines whether to use the MD area selected in SENSITIVITY.
- SEL POS : Determines which of the 4 vertices of each MD area is to be used.
- XPOS : Determines the coordinate of the horizontal axis for SEL POS.
- YPOS : Determines the coordinate of the vertical axis for SEL POS.
- FILL→SET : Fills in a selected MD area. The color of filling is sequentially selected as brown, orange, blue, cyan, green, yellow, magenta and red.
- RETURN : Select this to save the MOTION DET menu settings and return to the SPECIAL menu.

- PRIVACY : Mask an area you want to hide on the screen.

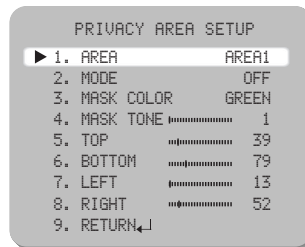

1) When the SPECIAL menu screen is displayed, press the Function Setup switch so that the arrow indicates 'PRIVACY'.

2) Set up the mode using the Function Setup switch.

- AREA : You can select up to 12 PRIVACY areas.
- MODE : Determines whether to use the area selected in the AREA.
- MASK COLOR : Determine area color. You can select Green, Red, Blue, Black, White, Gray.
- MASK TONE : Adjust the brightness of MASK COLOR.
- TOP/BOTTOM/LEFT/RIGHT : Adjust the size and position of the selected area.
- RETURN : Select this to save the PRIVACY menu settings and return to the SPECIAL menu.

➤ DIS (Digital Image Stabilizer) : This function mitigates any picture movement due to external factors such as wind.



Notes

- As the DIS function uses the digital zoom, the camera's resolution will decrease.
- DIS doesn't operate when background illumination is too low.
- DIS doesn't operate when object pattern is monotonic as like sky or white wall.

➤ LANGUAGE : You can select the menu language according to your requirements.

- NTSC : Korean, English, French, Spanish, Japanese, Portuguese, Taiwanese
- PAL : English, Chinese, German, Italian, French, Spanish, Russian, Czech, Polish, Romanian, Serbian, Swedish, Danish, Turkish, Portuguese

➤ RETURN : Select this to save the SPECIAL menu settings and return to the MAIN SETUP menu.

EXIT

Select a desired EXIT mode using the Function Setup switch depending on the camera purpose.

- SAVE : Save the current settings and exit the MAIN SETUP menu.
- NOT SAVE : Do not save the current settings and exit the MAIN SETUP menu.
- RESET : Resets the camera settings to the factory defaults. Language and Monitor settings are not initialized.

If you have trouble operating your camera, refer to the following table.

If the guidelines do not enable you to solve the problem, contact an authorized technician.

• Nothing appears on the screen.

- ▶ Check that the power cord and line connection between the camera and monitor are properly connected.
- ▶ Check that you have properly connected BNC cable to the camera.

• The image on the screen is dim.

- ▶ Is the lens stained with dirt? Clean your lens with soft, clean cloth.
- ▶ Set the monitor to the proper condition.
- ▶ If the camera is exposed to very strong light, change the camera position.

• The image on the screen is dark.

- ▶ Adjust the contrast feature of the monitor.
- ▶ If you have an intermediate device, set the 75Ω / Hi-z properly.

• The camera is not working properly, and the surface of the camera is hot.

- ▶ Check that you have properly connected the camera to an appropriate power source.

• The SENS-UP function does not work.

- ▶ Check that AGC of EXPOSURE SETUP menu is 'OFF'.
- ▶ Check that SHUTTER of EXPOSURE SETUP menu is 'A.FLK' or 'MANUAL'.

• The Motion Detection function does not work.

- ▶ Check that MOTION DET of SPECIAL SETUP menu is 'OFF'.

• Color is not correct.

- ▶ Check the setting of WHITE BAL SETUP menu.

• The screen flickers continually.

- ▶ Check that direction of camera turns toward the Sun.

• When coaxial communication is not available:

- ▶ Make sure that the camera and monitor are installed within the recommended distance.
- ▶ Use the video amplifier equivalent to coaxitron if the recommended installation distance is exceeded.

Specifications

Dimension

	SID-70N	SID-70P
ELECTRICAL		
Input Voltage	DC 12V / AC 24V	
Power Consumption	Max 3.5W	
VIDEO		
Imaging Device	1/3 inch, Diagonal 6mm Super HAD CCD	
Total Pixels	811(H) x 508(V)	795(H) x 596(V)
Effective Pixels	768(H) x 494(V)	752(H) x 582(V)
Scanning System	2:1 Interlace	
Synchronization	Internal / Line-Lock	
Frequency	H: 15.734KHz V:59.94Hz	H: 15.625KHz V: 50.00Hz
Horizontal Resolution	COLOR : 600TVL, B/W : 700TVL	
Min. Illumination	COLOR : 0.15 Lux (50IRE, @F1.2), 0.0003Lux (SENS-UP, x512) B/W : 0.001Lux (50IRE, @F1.2), 0.000002Lux (SENS-UP, x512)	
S/N (Y Signal)	52dB (Weight On, AGC Off)	
Video Output	CVBS : 1.0Vp-p, 75Ω composite	
LENS		
Zoom Ratio	3.6x (Manual)	
Focus Length	2.8 ~ 10.0mm (F1.2)	
Angular Field of View	Tele : 28°(H) x 21°(V), Wide : 94.4°(H) x 69.2°(V)	
PAN / TILT / ROTATE		
Pan / Tilt / Rotate Range	0°~352° / 0°~73° / 0°~348°	
OPERATIONAL		
Electronic Shutter Speed	1/60 ~ 1/120k sec	1/50 ~ 1/120k sec
ON Screen Display	NTSC : Korean, English, Japanese, Spanish, French, Portuguese, Taiwanese PAL : English, Chinese, German, Italian, French, Spanish, Russian, Czech, Polish, Romanian, Serbian, Swedish, Danish, Turkish, Portuguese	
SSDR	On / Off (Level adjustable)	
Backlight Compensation	BLC / HLC / OFF	
Day & Night	COLOR / BW / AUTO (ICR Type)	
Gain Control	Low / High / Off	
White Balance	ATW / Outdoor / Indoor / Manual / AWC (1,700°K ~ 11,000°K)	
SENS-UP (frame Integration)	Auto / Off (Selectable x2 ~ x512)	
Motion Detection	On / Off (8 Programmable zones)	
Privacy Masking	On / Off (12 Programmable zones)	
3D Noise Filter (SSNFill)	On / Off (Level adjustable)	
Digital Zoom	On / Off (x1 ~ x16)	
Digital Image Stabilization(DIS)	On / Off	
Camera Title	On / Off (Displayed 15 Characters)	
Sharpness	On / Off (Level adjustable)	
Flip / Mirror	On / Off	
Communication	Coaxial(Pelco Coaxitron)	
ENVIRONMENTAL		
Operating Temperature / Humidity	-10°C ~ +50°C / 30% ~ 80% RH	
Storage Temperature / Humidity	-20°C ~ +60°C / 20% ~ 90% RH	
MECHANICAL		
Dimension / Weight	Ø115.8 x 92.7(H)mm / 345g	

* The specification for this product may change without prior notice for product improvement.

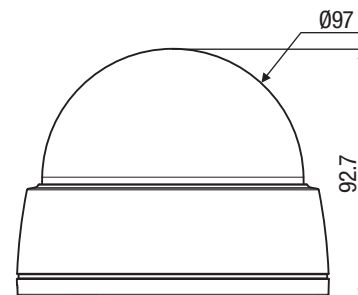
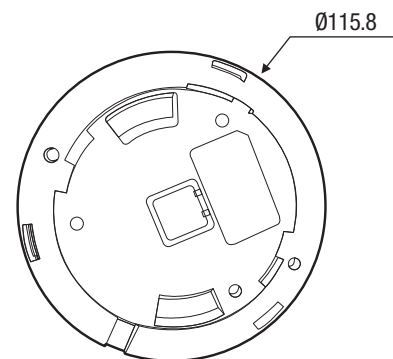

DECLARATION OF CONFORMITY

Application of Council Directive(s)	2004 / 108 / EC
Manufacturer's Name	SAMSUNG TECHWIN CO., LTD
Manufacturer's Address	SAMSUNG TECHWIN CO., LTD 42, SUNGJU-DONG CHANGWON-CITY, KYUNGNAM, KOREA, 641-716
European Representative Name	
European Representative Address	
Equipment Type/Environment	CCTV Camera
Model Name	SID-70P
Beginning Serial NO.	C10SA010007
Year of Manufacture	2009.11.01
Conformance to	EN 55022 : 2006 EN 50130-4 : 2003

We, the undersigned, hereby declare that the equipment specified above conforms to the above Directive(s).

Manufacturer	SAMSUNG TECHWIN CO., LTD	Legal Representative in Europe
Signature	<i>BonJeng Gu</i>	Signature
Full Name	BONJENG GU	Full Name
Position	QUALITY CONTROL MANAGER	Position
Place	CHANGWON, KOREA	Place
Date	2009.11.01	Date

MEMO

SAMSUNG TECHWIN

The Samsung logo, consisting of the word "SAMSUNG" in a bold, sans-serif font, enclosed within a black, horizontally-oriented oval.

SALES NETWORK

• **SAMSUNG TECHWIN CO., LTD.**

145-3, Sangdaewon 1-dong, Jungwon-gu, Seongnam-si Gyeonggi-do, Korea, 462-703
TEL : +82-31-740-8151-8 FAX : +82-31-740-8145

• **SAMSUNG TECHWIN AMERICA Inc.**

1480 Charles Willard St, Carson, CA 90746, UNITED STATES
Tol Free : +1-877-213-1222 FAX : +1-310-632-2195
www.samsungcctvusa.com

• **SAMSUNG TECHWIN EUROPE CO., LTD.**

Samsung House, 1000 Hillswood Drive, Hillswood Business
Park Chertsey, Surrey, UNITED KINGDOM KT16 0PS
TEL : +44-1932-45-5300 FAX : +44-1932-45-5325

www.samsungtechwin.com
www.samsungcctv.com

P/No. : Z6806-1103-01A

Download from Www.Somanuals.com. All Manuals Search And Download.

VAN 09, 11

Free Manuals Download Website

<http://myh66.com>

<http://usermanuals.us>

<http://www.somanuals.com>

<http://www.4manuals.cc>

<http://www.manual-lib.com>

<http://www.404manual.com>

<http://www.luxmanual.com>

<http://aubethermostatmanual.com>

Golf course search by state

<http://golfingnear.com>

Email search by domain

<http://emailbydomain.com>

Auto manuals search

<http://auto.somanuals.com>

TV manuals search

<http://tv.somanuals.com>