

COLOR CCD camera

About this manual

Before installing and using the camera, please read this manual carefully. Be sure to keep it handy for later reference.

● Dimensions: mm

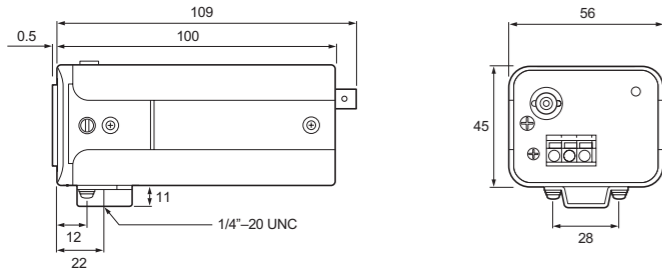

Accessories

- Lens iris plug

Depending on the conditions of use, installation and environment, please be sure to make the appropriate settings and adjustments. If you need help with installation and/or settings, please consult your dealer.

INFORMATION TO USER

Safety Guard



THIS SYMBOL INDICATES THAT THERE ARE IMPORTANT OPERATING AND MAINTENANCE INSTRUCTIONS IN THE LITERATURE ACCOMPANYING THIS UNIT.

WARNING:
TO PREVENT THE RISK OF FIRE OR ELECTRIC SHOCK, DO NOT EXPOSE THIS APPLIANCE TO RAIN OR MOISTURE.

For the customers in Canada

This Class B digital apparatus complies with Canadian ICES-003.

Pour la clientèle canadienne

Cet appareil numérique de la Classe B est conforme à la norme NMB-003 du Canada.

This installation should be made by a qualified service person and should conform to all local codes.

This equipment has been tested and found to comply with the limits for a Class B digital device, pursuant to Part 15 of the FCC Rules.

These limits are designed to provide reasonable protection against harmful interference in a residential installation. This equipment generates, uses, and can radiate radio frequency energy and, if not installed and used in accordance with the instructions, may cause harmful interference to radio communications.

However, there is no guarantee that interference will not occur in a particular installation. If this equipment does cause harmful interference to radio or television reception, which can be determined by turning the equipment off and on, the user is encouraged to try to correct the interference by one or more of the following measures:

- Reorient or relocate the receiving antenna.
- Increase the separation between the equipment and receiver.
- Connect the equipment into an outlet on a circuit different from that to which the receiver is connected.
- Consult the dealer or an experienced radio/TV technician for help.

This device complies with Part 15 of the FCC Rules. Operation is subject to the following two conditions: (1) This device may not cause harmful interference, and (2) this device must accept any interference received, including interference that may cause undesired operation.

Changes or modifications not expressly approved by Sanyo may void the user's authority to operate this camera.

PRECAUTIONS

■ In case of problem

Do not use the camera if smoke or strange odors come from the unit, or if it seems not to function correctly. Disconnect the power cord immediately, and consult your dealer or a Sanyo Authorized Service Center.

■ Do not open or modify

Do not open the cabinet, as it may be dangerous and cause damage to the unit. For internal settings and repairs, consult your dealer or a Sanyo Authorized Service Center.

■ Do not put objects inside the unit

Make sure that no metal objects or flammable substances get inside the camera. If used with a foreign object inside, it could cause fire, short-circuits or damage. If water or liquid gets inside the camera, disconnect the power cord immediately, and consult your dealer or a Sanyo Authorized Service Center. Be careful to protect the camera from rain, sea water, etc.

■ Be careful when handling the unit

To prevent damage, do not drop the camera or subject it to strong shock or vibration.

■ Install away from electric or magnetic fields

If installed close to a TV, radio transmitter, magnet, electric motor, transformer, or audio speakers, the magnetic field they generate will distort the image.

■ Protect from humidity and dust

To prevent damage to the camera, do not install it where there is greasy smoke or steam, where humidity may get too high, or where there is a lot of dust.

■ Protect from high temperatures

Do not install close to stoves, or other heat generating devices, such as spotlights, or where it could be subject to direct sunlight, as that could cause deformation, discoloration or other damage. Be careful when installing close to the ceiling, in a kitchen or boiler room, as the temperature may rise to high levels. Install where the temperature range will stay between -10°C (14°F) and 50°C (122°F). (no condensation)

■ Cleaning

- Dirt can be removed from the cabinet by wiping it with a soft cloth. To remove stains, use a soft cloth moistened with a soft detergent solution and wrung dry, then dry by wiping with a soft dry cloth.
- Do not use benzine, thinner or other chemical products on the cabinet, as they may cause deformation and paint peeling. Before using a chemical cloth, make sure to read all accompanying instructions. Make sure that no plastic or rubber material comes in contact with the cabinet for extended periods, as that may cause damage or paint peeling.

Printed on recycled paper

1AC6P1P2713--
L53X4/US3 (0308TR-SY)



SANYO Electric Co., Ltd.
Printed in Japan

NAMES AND FUNCTIONS OF PARTS

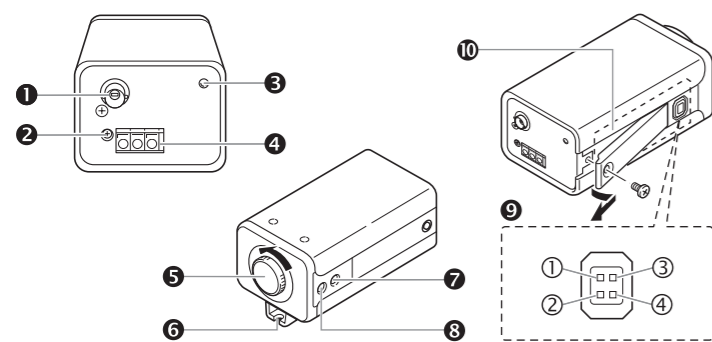

① VIDEO OUT (video output terminal: BNC connector)

Connects to the VIDEO IN (video input) terminal on the VCR or monitor.

② LINE PHASE (Line phase adjustment volume)

When using two cameras or more, the image on the monitor may roll vertically when switching sources. This rolling can be minimized by turning this volume.

③ POWER (power indicator)

Lights when the camera power is ON.

④ GND, AC24V, DC12V (ground terminal, 24V AC or 12V DC input terminal)

⑤ Lens cap

Protects the lens from damage.

⑥ Camera attachment bracket

Used to attach the camera.

⑦ Flange-back lock screw

⑧ Flange-back adjustment screw

⑨ LENS (lens iris output terminal)

Used to connect the lens plug when the lens is attached.

- ① Brake coil (-) ② Brake coil (+)
- ③ Drive coil (+) ④ Drive coil (-)

⑩ Camera adjustment/setting panel

Contains camera adjustment dials and setting switches.

● Attaching the lens

Use a DC type auto-iris lens (sold separately).

! CAUTION

- Do not use a lens if length "L" is more than 5 mm. Otherwise, it may damage the camera and prevent proper installation.
- When attaching a C mount lens, attach the lens to the camera after inserting the C mount ring (option).

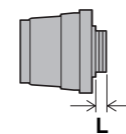

1 Remove the lens mount cap from the camera.

2 Install the auto-iris lens.

3 Connect the lens plug to the lens iris output connector (LENS) on the side of the camera.

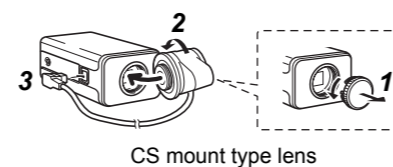

CS mount type lens

! CAUTION

When using lenses from other manufacturers, the plug shape may not correspond to the terminal on the camera. In such a case, remove the original plug and using a soldering iron, connect the supplied lens iris plug according to the diagram.

● Rewiring the lens cable in the lens iris plug

1 Prepare the lens cable.

Cut the cable at the plug, then remove approx. 8 mm of the cable sheath and strip about 2 mm from each wire.



2 Install the lens iris plug.

Solder the cable to the pins following the correct pin layout (⑨), then close the plug cover.



TROUBLESHOOTING

Before sending the camera out for repair, check the items below.

If the problem persists after checking these items, contact your place of purchase or a Sanyo Authorized Service Center.

■ If no image appears

- Is the coaxial cable attached securely?
- Are the power and voltage normal?
- Has the iris of the lens inside the camera been adjusted correctly (with the iris dial)?
- Is there adequate illumination?

■ If the image is unclear

- Is the monitor adjusted correctly?
- Is the flange-back position correctly set?
- Is the lens in focus?
- Is the lens dirty?
Dirt or fingerprints on the lens can adversely affect the image. Gently wipe any dirt or fingerprints off the lens with a soft cloth or lens cleaning paper and cleaning fluid (commercially available).

SERVICE

The camera is a precision instrument. Handle it carefully and always follow the safety precautions. If the camera requires service, never try to repair it yourself or open the casing.

For servicing, maintenance, or repairs, contact your place of purchase or a Sanyo Authorized Service Center.

SPECIFICATIONS

Scanning system	: NTSC standard TV system (525 TV lines, 30 frames/sec.)
Interlace	: PLL 2:1 interlace
Image device	: 1/3 inch solid state image device CCD
Picture elements	: 816 (H) x 494 (V)
Effective picture elements	: 771 (H) x 492 (V)
Synchronizing system	: Internal sync, Line lock manually switchable
Resolution	: 520 TV lines horizontally, 350 TV lines vertically
Video output level	: 1.0 Vp-p/75 ohms, composite
Video S/N ratio	: More than 48 dB
Minimum required illumination (incandescent lighting)	: Approx. 0.6 lux with a F 1.2 lens (at Gain up: HI) Approx. 1.2 lux with a F 1.2 lens (at Gain up: NORM)
Backlight compensation	: Manual MULT/CENT/OFF switching, MULT: Multi-spot metering system CENT: Center-weighted metering system (Active when using an auto-iris lens)
Iris function	: Manual EI/AI switching
Auto-iris lens output	: DC output (variable DC level), 4-pin terminal
Electronic iris range	: 0.6 lux to 30000 lux (F 1.2, lens: Gain up: HI) 1.2 lux to 60000 lux (F 1.2, lens: Gain up: NORM)
Flange-back	: 12.5 mm ±0.5 mm
White balance	: ATW/Manual switching
Gain up	: HI (high)/ NORM (Normal) switching
Lens mount	: CS mount
Environmental conditions	: Temperature: -10°C – +50°C Humidity: less than 90% (no condensation)
Power supply	: 12 VDC/24 VAC, 60 Hz
Power consumption	: 3.6 W (with auto iris lens)
Weight	: Approx. 310 g (without lens)

Features and specifications are subject to change without prior notice or obligations.

CONNECTIONS AND INSTALLATION

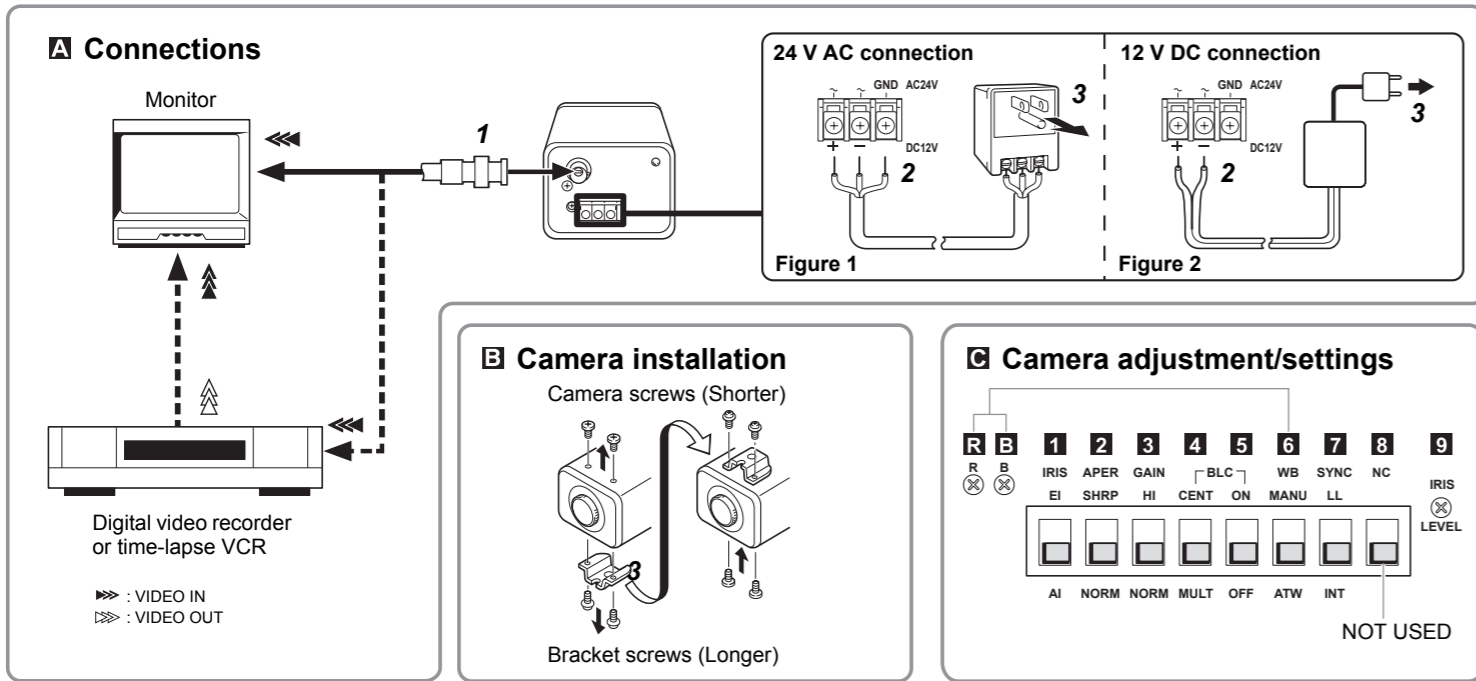

A CONNECTIONS

What you need

- Peripheral equipment (such as monitor, digital video recorder or time-lapse VCR)
- Cables for connecting peripheral equipment and camera (coaxial cables, connecting plugs)
- Power adapter (24 V AC or 12 V DC)

Supported coaxial cables

You can use any of the following coaxial cables:

- RG-59U (3C-2V) Length: 250 m max.
- RG-6U (5C-2V) Length: 500 m max.
- RG-11U (7C-2V) Length: 600 m max.

CAUTION

- When using an RG-59U (3C-2V) cable, do not use it on piping or air wiring.
- Select the cable according to the distance between the devices you wish to connect.
- If you use a cable other than the types above, the image or sync signal will be attenuated and will not be transmitted correctly.

Making connections

- Connect the camera and peripheral equipment.
- Connect the power cable.
 - <When using a 24 V AC adapter> Connect 3 wire grounded cable (use 18AWG+) as shown in Figure 1.
 - <When using a 12 V DC adapter> Connect the cable as shown in Figure 2.

CAUTION

- When connecting the power cable to the camera, check that the polarity is correct.
 - To prevent a fire hazard use any UL listed wire rated VW-1 for the 24 V AC cable input terminal.
- Insert the power adapter plug into the wall outlet. The power indicator (POWER) lights.

B CAMERA INSTALLATION

Camera attachment bracket

As shown in Figure B above, you can remove the camera attachment bracket and reattach it to the camera bottom if you want to attach the camera to the top of an object. If you remove the camera attachment bracket, be sure to use the removed screws when reattaching it (other screws may not fit).

CAUTION

When using the camera attachment stand (sold separately), select a location that will be able to withstand the weight of the camera and stand for many years, and fix them securely in place.

Flange-back adjustment

If the pick-up surface is not correctly positioned with relation to the lens focal point, the picture will be out of focus (in particular when using auto-iris power zoom lenses, sold separately). If that is the case, adjust the flange-back position as described below.

- Using a + screwdriver, loosen the flange-back lock screw (M2:+) .
- Set the zoom lens to the maximum telephoto position, and set the focus using the focus ring on the lens.
- Set the zoom lens to the maximum wide angle position, and set the focus using the flange-back adjustment screw.
- Repeat steps 2 and 3, until the image stays in focus when changing from a telephoto shot to a wide angle shot. When the setting is complete, tighten the flange-back lock screw.

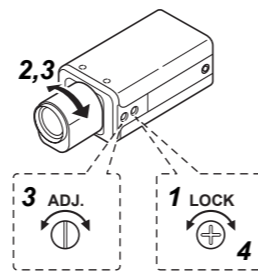

C CAMERA ADJUSTMENTS/SETTINGS

The camera comes pre-adjusted and ready to install at time of factory shipment, but you may want to make adjustments or settings to adapt to the operating conditions or installation environment. If you have trouble adjusting the camera, contact your place of purchase or a Sanyo Authorized Service Center.

Iris setting 1

Change Iris setting when using either lens below.

EI (for indoor use)	When using a manual or fixed iris lens and the electronic iris function is on. * Set the lens aperture to the shortest F stop.
AI	When using an auto-iris lens.

ADJUSTMENT AND SETTINGS

CAUTION

- The electronic iris is suitable for normal indoor use. When switch 1 (IRIS) is set to the up (EI) position, do not use an auto-iris lens.
- If used under fluorescent light, the image may flicker. In such a case, change to incandescent lighting or set switch 1 (IRIS) to the down (AI) position and use an auto-iris lens.
- When shooting bright subjects, pay attention to the light angle in order to avoid or minimize the smear effect.
- If conditions are outside the electronic iris operation range or more than the maximum illumination, the CCD will be saturated. In that case, use the auto iris lens.

Aperture (outline compensation) 2

If object outlines appear too strongly, set to "NORM".

SHRP	Emphasizes object outlines.
NORM	Normal setting

Gain control (AGC) 3

For adjusting the sensitivity of the camera. Use this setting for shooting in dark environments.

HI	Increased sensitivity allows shots to be taken in dark environments.
NORM	Normal setting

CAUTION

The HI setting causes noise generation and a grainy image.

Backlight compensation 4 5

You can set the metering area (□□□□), to have the lens iris adjust automatically to make the image easy to see when the object is backlit.

<p>4 5</p> <p>When there is backlight in the entire screen</p>	<p>Multi-spot metering The screen is divided into 64 areas, and each area is metered and backlight-compensated.</p> <p>CAUTION If the background of the object is extremely dark, the center of the object may be too bright. In this case, set center-weighted metering mode.</p>
<p>4 5</p> <p>When there is backlight only in the background</p>	<p>Center-weighted metering Only the center of the image is metered and backlight-compensated.</p>

SANYO INDUSTRIAL VIDEO COLOR VIDEO CAMERA LIMITED WARRANTY

OBLIGATIONS

In order to obtain warranty service, the product must be delivered to and picked up from an Authorized Sanyo Service Center at the user's expense, unless specifically stated otherwise in this warranty. The names and addresses of Authorized Sanyo Service Centers may be obtained by calling the toll-free number listed below.

For product operation, authorized service center referral, service assistance or problem resolution, call

CUSTOMER INFORMATION 1-800-421-5013
Weekdays 8:30 AM - 5:00 PM Pacific Time

For accessories and/or parts, call

PARTS ORDER INFORMATION 1-800-726-9662
Weekdays 8:30 AM - 5:00 PM Pacific Time

THIS WARRANTY IS VALID ONLY ON SANYO PRODUCTS PURCHASED OR RENTED IN THE UNITED STATES OF AMERICA, EXCLUDING ALL U.S. TERRITORIES AND PROTECTORATES. THIS WARRANTY APPLIES ONLY TO THE ORIGINAL RETAIL PURCHASER OR END-USER. THE ORIGINAL DATED BILL OF SALE, SALES SLIP OR RENTAL AGREEMENT MUST BE SUBMITTED TO THE AUTHORIZED SANYO SERVICE CENTER AT THE TIME WARRANTY SERVICE IS REQUESTED. Subject to the OBLIGATIONS above and EXCLUSIONS below, SANYO Fisher Company warrants this SANYO product against defects in materials and workmanship for the periods specified below. SFC will repair or replace (at its option) the product and any of its parts which fail to conform to this warranty. The warranty period commences on the date the product was first purchased or rented at retail.

LABOR	PARTS	IMAGE DEVICE
3 YEARS	3 YEARS	3 YEARS

EXCLUSIONS

This warranty does not cover (A) the adjustment of customer-operated controls as explained in the appropriate model's instruction manual, or (B) the repair of any product whose serial number has been altered, defaced or removed. This warranty shall not apply to the cabinet or cosmetic parts, batteries or routine maintenance. This warranty does not apply to repairs or replacements necessitated by any cause beyond the control of SFC including, but not limited to, any malfunction, defect or failure caused by or resulting from unauthorized service or parts, improper maintenance, operation contrary to furnished instructions, shipping or transit accidents, modification or repair by the user, abuse, misuse, neglect, accident, incorrect power line voltage, fire, flood or other Acts of God, or normal wear and tear. The foregoing is in lieu of all other expressed warranties and SFC does not assume or authorize any party to assume for it any other obligation or liability. SFC DISCLAIMS ALL OTHER WARRANTIES EXPRESS OR IMPLIED, WITH REGARD TO THIS PRODUCT (INCLUDING THE WARRANTIES OF MERCHANTABILITY AND FITNESS). IN NO EVENT SHALL SFC BE LIABLE FOR ANY SPECIAL, INCIDENTAL OR CONSEQUENTIAL DAMAGES ARISING FROM THE OWNERSHIP OR USE OF THIS PRODUCT OR FOR ANY DELAY IN THE PERFORMANCE OF ITS OBLIGATIONS UNDER THIS WARRANTY DUE TO CAUSES BEYOND ITS CONTROL. SFC'S LIABILITY FOR ANY AND ALL LOSSES AND DAMAGES RESULTING FROM ANY CAUSE WHATSOEVER, ARISING OUT OF OR IN CONNECTION WITH THE SALE, USE OR OWNERSHIP OF THIS PRODUCT INCLUDING WARRANTOR'S NEGLIGENCE, ALLEGED DAMAGED OR DEFECTIVE GOODS, WHETHER SUCH DEFECTS ARE DISCOVERABLE OR LATENT, SHALL IN NO EVENT EXCEED THE PURCHASE PRICE OF THE PRODUCT.

ATTENTION

For your protection in the event of theft or loss of this product, please fill in the information below for your own personal records.

Model No. _____ Serial No. _____
(Located on back or bottom side of unit.)
Date of Purchase _____ Purchase Price _____
Where Purchased _____

White balance (color compensation) 6 R B

MANU	Lets you fine-tune the white balance manually.	
WB	R (Red) dial R	Turn clockwise to augment screen red.
	B (Blue) dial B	Turn clockwise to augment screen blue.
ATW	Compensation is performed automatically.	

Sync setting 7

Vertical sync disturbance may occur when a selector is used to switch between multiple cameras connected to one monitor. To prevent vertical sync disturbance, set to "LL."

LL (external sync)	Adjust PHASE dial to eliminate sync disturbance.
INT (internal sync)	Internal Sync

- LL (Line-Lock): Synchronizes the unit with power frequency.

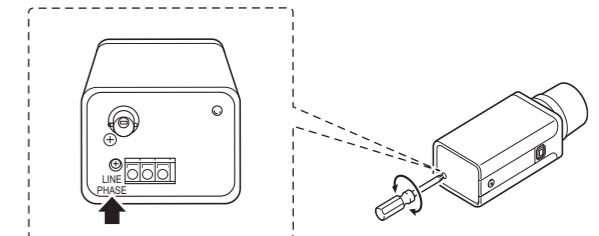

CAUTION

If image disturbance doesn't disappear after adjusting the PHASE dial on the second and subsequent cameras, adjust the PHASE dial on the first camera. If the problem persists, check that all the devices have been connected with the correct power cable polarity.

Iris dial (lens iris) 9

If the entire image is too dark or too bright, adjust the LEVEL dial (9).

Counterclockwise	Closes the lens iris, making the entire image darker.
Clockwise	Opens the lens iris, making the entire image brighter.

Free Manuals Download Website

<http://myh66.com>

<http://usermanuals.us>

<http://www.somanuals.com>

<http://www.4manuals.cc>

<http://www.manual-lib.com>

<http://www.404manual.com>

<http://www.luxmanual.com>

<http://aubethermostatmanual.com>

Golf course search by state

<http://golfingnear.com>

Email search by domain

<http://emailbydomain.com>

Auto manuals search

<http://auto.somanuals.com>

TV manuals search

<http://tv.somanuals.com>