



INSTRUCTION MANUAL

VCC-MC800P VCC-MC700P

Color CCD Camera

About this manual

Before installing and using this unit, please read this manual carefully.
Be sure to keep it handy for later reference.



Contents

| | | | |
|---|----|---|----|
| Main Features | 2 | ⓐ Displaying a still image while switching the surveillance location (FREEZE) | 31 |
| Precautions | 3 | ⓓ Setting the starting point (0 degrees) angle information (SET NORTH) | 31 |
| Before Using the Menu | 4 | ⓔ Limiting the tilting angle (TILT LIMIT) | 32 |
| Basic Operations for Performing Settings in the Menu | 5 | Auto Mode Settings (AUTO MODE) | 33 |
| About Setting Menus | 6 | ⓐ Monitoring multiple preset positions sequentially (SEQUENCE) | 34 |
| ■ Setting menu mode | 6 | ⓔ Panning between two surveillance locations in loop (AUTO PAN) | 35 |
| ■ Setting menu composition | 7 | ⓐ Repeating a recorded monitoring process (TOUR) | 36 |
| Camera Settings (CAMERA) | 8 | ⓓ Returning automatically to the specified surveillance mode (AUTO RETURN) | 37 |
| ⓐ Adjusting synchronization signal (SYNC) | 10 | Alarm Settings (ALARM) | 38 |
| ⓔ Setting lens aperture (IRIS) | 11 | ⓐ Setting the alarm input (ALARM IN) | 39 |
| ■ Auto iris (AUTO) | 11 | ⓔ Setting the alarm output (ALARM OUT) | 40 |
| ■ Manual iris (MANU) | 11 | ⓐ Setting the alarm disabling duration (ALARM DISABLE) | 41 |
| ⓐ Setting the white balance (WHITE BALANCE) | 12 | ⓓ Setting the motion sensor (MOTION) | 41 |
| ■ Auto trace white balance (ATW) | 12 | ■ Setting the motion zone | 41 |
| ■ One-push automatic white balance (AWC) | 13 | ■ Setting the detection sensitivity | 42 |
| ■ Fixed white balance (3200/5600/FLUO) | 13 | ⓔ Setting the alarm information display (ALARM DISPLAY) | 43 |
| ■ Manual white balance (MWB) | 13 | Privacy Mask Settings (PRIVACY MASK) | 44 |
| ⓓ Setting the backlight compensation level (BLC) | 14 | Password Settings (PASSWORD) | 45 |
| ■ Multi-spot evaluative metering (MULT) | 14 | ■ Enabling password lock | 45 |
| ■ Center-weighted average metering (CENT) | 14 | ■ Disabling password lock | 45 |
| ■ Multi-spot metering (MASK) | 15 | ■ Changing the password | 46 |
| ⓔ Setting the electronic shutter (SHUTTER) | 16 | Language Settings (LANGUAGE) | 47 |
| ■ Fast shutter speed (SHORT) | 16 | Miscellaneous Settings (OPTION) | 48 |
| ■ Slow shutter speed (LONG) | 16 | ⓐ Setting the display information (INFORMATION) | 49 |
| ⓔ Setting the profile compensation (APERTURE) | 17 | ■ Setting the item to be displayed (DISPLAY) | 49 |
| ⓐ Setting the AGC level (AGC) | 17 | ■ Displaying the system information (SYSTEM) | 49 |
| ⓔ Setting the gamma correction level (GAMMA) | 18 | ⓔ Setting the auto flip function (AUTO FLIP) | 50 |
| ⓐ Setting the Day/Night function (DAY/NIGHT) | 19 | ⓐ Correcting the sway of the camera (STABILIZER) | 50 |
| ■ Setting the Day/Night function (AUTO) | 19 | ⓓ Setting the auto pursuit function (AUTO PURSUIT) | 51 |
| ■ Using the color mode only (COLOR) | 20 | ⓔ Setting the mirroring function (MIRROR) | 51 |
| ■ Using the black and white mode only (B/W) | 21 | ⓔ Performing the refresh function (REFRESH) | 51 |
| Lens Settings (LENS) | 22 | Menu Structure Diagram | 52 |
| ⓐ Setting the focusing mode (FOCUS) | 22 | Specifications | 57 |
| ■ Auto focus (AUTO) | 22 | | |
| ■ Manual focus (MANU) | 23 | | |
| ⓔ Setting the zooming operations (ZOOM) | 24 | | |
| Pan and Tilt Settings (PAN/TILT) | 25 | | |
| ⓐ Registering a surveillance location (PRESET POSITION) | 26 | | |
| ■ Determining the surveillance position (POSITION) | 26 | | |
| ■ Specifying the camera ID and title | 26 | | |
| ■ Registering a view setting file (CAMERA VIEW) | 27 | | |
| ■ Grouping the preset positions (SEQUENCE GROUP) | 29 | | |
| ■ Deleting a preset position (DELETE) | 30 | | |
| ■ Switching to a preset position (PRESET GO) | 30 | | |
| ⓔ Making the amount of movement in the screen constant (PROPORTIONAL) | 31 | | |

Main Features

- X36 optical zoom
- High precision mechanism enabling high speed 360 degrees rotation
- -5 to 185 degrees tilting angle
- Easy installation and removal

Providing clearer monitored images

- Detailed surveillance options including auto focus, auto iris, white balance, backlight/profile compensation, electronic shutter and AGC
- DAY/NIGHT function enabling 24-hour surveillance
- Up to 256 preset positions and 4 preset position groups are supported
- Up to 8 camera view setting files can be saved for storing camera setting patterns

Four types of auto mode settings

- ① **SEQUENCE mode**
In this mode, surveillance locations can automatically be moved to multiple preset positions sequentially.
- ② **AUTO PAN mode**
Automatic pan between two surveillance locations in loop can be set after storing start and end locations.
- ③ **TOUR mode**
Sequential manual operations such as panning, tilting and zooming can be saved as a movement track, and the movement track can be used to automatically repeat the set of camera operations.
- ④ **AUTO RETURN mode**
You can automatically return the surveillance status to the specified surveillance mode after the specified duration has passed without any operations.

- Auto pursuit function
- Sway correction function

Alarm detection function

- Both built-in and externally connected motion sensors can be used simultaneously.
- Detailed input/output options for alarm signals are available for linking external devices such as recorder and alarm buzzer.

Protecting privacy and ensuring security

- Masking patterns can be placed over defined image areas to protect privacy.
- Password authorization can be set for camera operation.

Additional convenient functions

- Automatic image flipping (AUTO FLIP) function allows you to view the surveillance image in an upright position when the camera is tilted beyond the straight down position and the on-screen image is inverted.
The sway correction function and the auto pursuit functions are newly featured as standard.
- The MIRRORING function enables surveillance from the camera set up on the floor.
- The automatic cleaning function keeps horizontal rotation of the camera in smooth working order.

Supported protocols: SSP, HSSP, Pelco-D, Pelco-C

Memo: To operate the camera, the separately sold Power Board Unit <VA-84S (for AC24V) or VA-80S (for AC230V)> is required. The power board unit can be removed easily from the camera unit by using the releasing levers.

Expendable items

The following parts are expendable items. Be sure to replace them after their work life has expired. Component performance cannot be guaranteed when parts are used to the very end of their projected work life. Durability will differ according to environmental conditions and usage.

- Lens unit: about 20,000 hours (Motor: 1,200,000 operations)
- Slip ring: about 20,000 hours (1,200,000 rotations)
- Motor: about 33,000 hours (12,000,000 revolutions)
- Fan: about 30,000 hours

Accessories

- Clamping core (large) x 2 (square type)

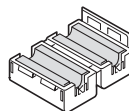

- Clamping core (small) x 1 (round type)

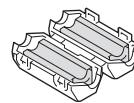

For installing the core, refer to the supplied installation manual.

Precautions

■ In case of a problem

Do not use the unit if smoke or a strange odor comes from the unit, or if it seems not to function correctly. Turn off the power immediately and disconnect the power cord, and then consult your dealer or an Authorized Sanyo Service Center.

■ Do not open or modify

Do not open the cabinet, as it may be dangerous and cause damage to the unit. For repairs, consult your dealer or an Authorized Sanyo Service Center.

■ Do not put objects inside the unit

Make sure that no metal objects or flammable substance get inside the unit. If used with a foreign object inside, it could cause a fire, a short-circuit or damage. Be careful to protect the unit from rain, sea water, etc. If water or liquid gets inside the unit, turn off the power immediately and disconnect the power cord, and then consult your dealer or an Authorized Sanyo Service Center.

■ Be careful when handling the unit

To prevent damage, do not drop the unit or subject it to strong shock or vibration.

■ Do not install this unit close to magnetic fields

The magnetic fields may result in unstable operation.

■ Protect from humidity and dust

To prevent damage, do not install the unit where there is greasy smoke or steam, where the humidity may get too high, or where there is a lot of dust.

■ Protect from high temperatures

Do not install close to stoves, or other heat sources, such as spotlights, etc., or where it could be subject to direct sunlight, as this could cause deformation, discoloration or other damage.

Be careful when installing close to the ceiling, in a kitchen or boiler room, as the temperature may rise to high levels.

■ Cleaning

- Dirt can be removed from the cabinet by wiping it with a soft cloth. To remove stains, wipe with a soft cloth moistened with a soft detergent solution and wrung dry, then dry by wiping with a soft cloth.
- Do not use benzine, thinner or other chemical products on the cabinet, as this may cause deformation and paint peeling. Before using a chemical cloth, make sure to read all accompanying instructions. Make sure that no plastic or rubber material comes into contact with the cabinet for a long period of time, as this may cause damage or paint peeling.

■ Installing the camera

To avoid an accident caused by a falling camera, when installing the camera, be sure to follow the installation manual and fix the camera to a durable ceiling, floor or wall securely.

■ WEEE Symbol Information



Please note:

Your SANYO product is designed and manufactured with high quality materials and components which can be recycled and reused.

This symbol means that electrical and electronic equipment, at their end-of-life, should be disposed of separately from your household waste.

Please dispose of this equipment at your local community waste collection/recycling centre.

In the European Union there are separate collection systems for used electrical and electronic products.

Please help us to conserve the environment we live in!

This symbol mark and recycle system are applied only to EU countries and not applied to the countries in the other area of the world.

Before Using the Menu

After installing the camera, use the menu to select camera operating options and required functions according to your operating environment and surveillance purpose. Use the system controller (VSP-9000) to perform menu setting operations while viewing the menu on the monitor screen. (The VAC-70, VSP-8500 also can be used to operate the camera.)

- **To operate the system controller using the RS485 control method:**
For system control setting switches (B), set the No.3 switch to the lower position (OFF).
- **To operate the system controller using the coaxial control method:**
For system control setting switches (B), set the No.3 switch to the upper position (ON).

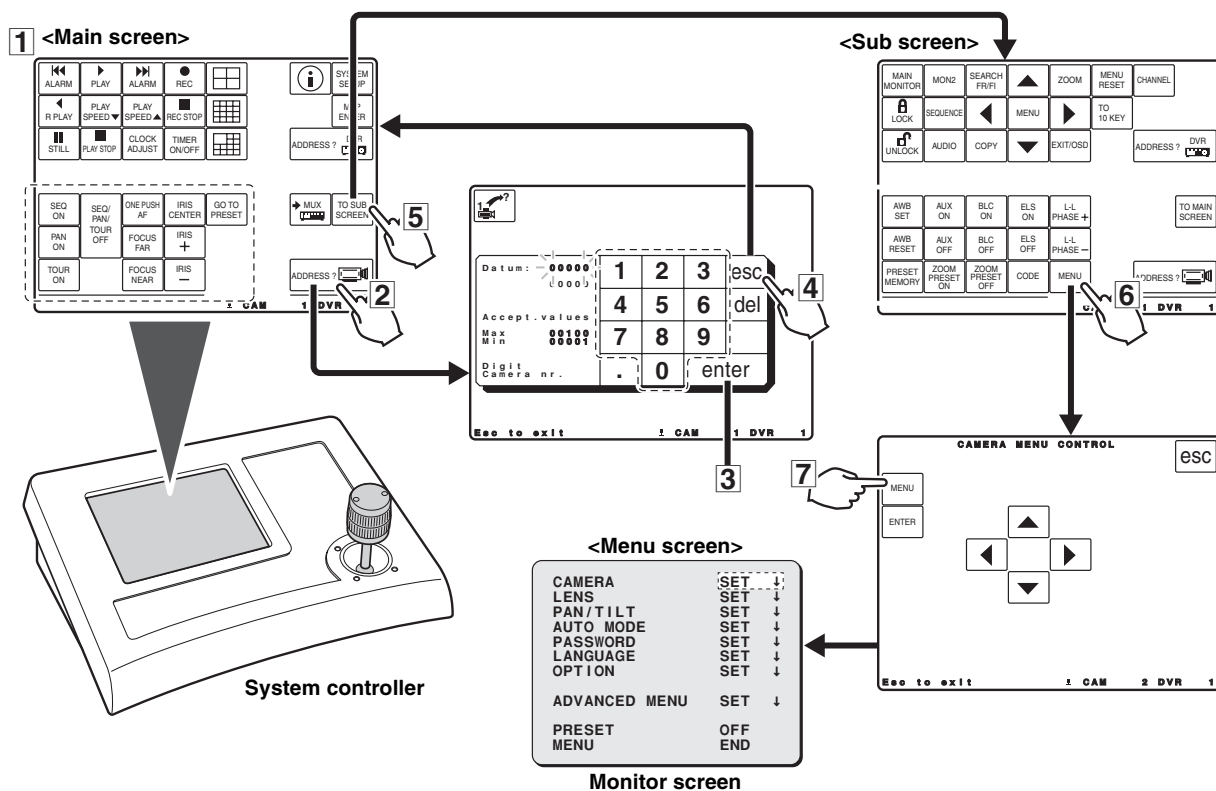
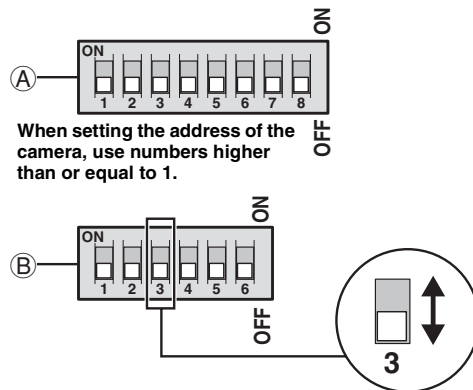

- 1 Make connections with all equipment and turn them on.**
When the power is turned on, the camera will perform its startup movements. The camera's address and other information will be displayed on the monitor screen. After the startup movements have been completed, live image will be displayed.
The main screen appears on the touch panel of the system controller.
- 2 Press the [ADDRESS?] button.**
The address entering screen appears.
- 3 Enter the camera's address using the 10 key buttons, and press the [enter] button.**
The address (camera number) entered here is the one specified with the address setting switches (A) and is displayed on the monitor screen during the startup movements.
- 4 Press the [esc] button.**
The main screen appears again.
- 5 Press the [TO SUB SCREEN] button.**
The sub screen appears.
- 6 Press the [MENU] button in the sub screen.**
The CAMERA MENU CONTROL screen appears.
- 7 Press the [MENU] button in the CAMERA MENU CONTROL screen.**
The camera menu appears on the monitor screen.

Basic Operations for Performing Settings in the Menu

To perform settings in the menu, use the joystick lever (①) on the system controller and the [ENTER] button (②) in the CAMERA MENU CONTROL screen.

- Joystick lever:**
 Used to move the cursor or select menu options.
 Instead of the joystick lever, the control buttons shown in (③) in the CAMERA MENU CONTROL screen can be used to move the cursor or select menu options.
- [ENTER] button:**
 Used to confirm your selection or execute operation commands.

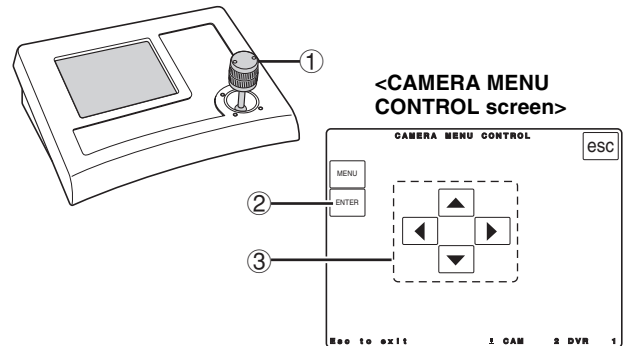

Memo: Some settings in the menu can be performed by using the sub screen on the system controller. For details, refer to the system controller instruction manual.

● To select the menu to perform settings

Use the joystick lever (↑↓) to move the cursor highlighting the menu item up or down. Move the cursor to your desired menu item using the lever.

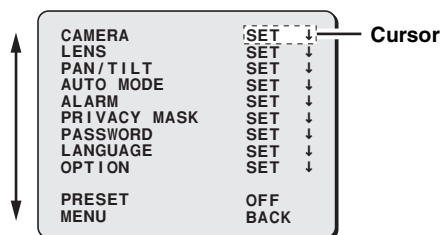

● To display an advanced setting screen for the selected menu

The menu item shown with ↓ mark has an advanced setting screen. After selecting the menu item with ↓ mark, press the [ENTER] button to display the advanced setting screen.

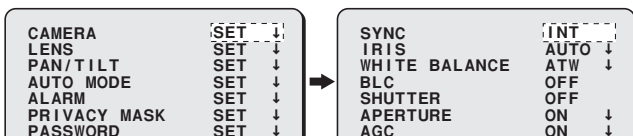

● To select an option for the setting item

Use the joystick lever (←→) to display the available options in turn.

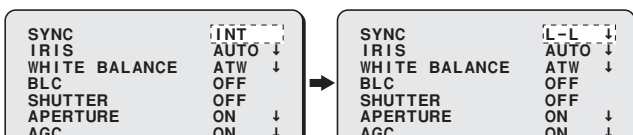

● To go back to a previous setting screen

Move the cursor to "MENU" and select the "BACK" option, then press the [ENTER] button.

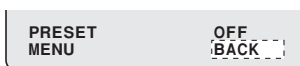

● To exit from the menu screen

Move the cursor to "MENU" and select the "END" option, then press the [ENTER] button.

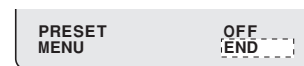

Memo: If there is no menu operation for three minutes or more, the menu screen is automatically exited.

● To display the menu screen again

Press the [MENU] button in the CAMERA MENU CONTROL screen.

● To restore your selected options to initial values

Move the cursor to "PRESET" and change its option to "ON", then press the [ENTER] button.

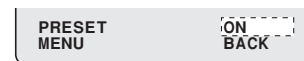

Memo: The following settings cannot be restored.

- Privacy mask
- Preset position
- Camera view
- Camera title
- Password

☞ In this manual, ↑↓ represent vertical joystick lever operation and ←→ represent horizontal joystick lever operation.

About Setting Menus

■ Setting menu mode

For performing settings in the menu, the following two menu modes are available.

● Main menu

This menu, which is provided for general users, appears by pressing the [MENU] button in the CAMERA MENU CONTROL screen. Some menu items and setting options, which are available in the advanced menu, are omitted in the main menu.

● Advanced menu

This menu, which is provided for administrative users, appears by selecting [ADVANCED MENU] in the main menu. In the advanced menu, the menu items for the [ALARM] and [PRIVACY MASK] settings are added and advanced settings can be made on individual menu screens.

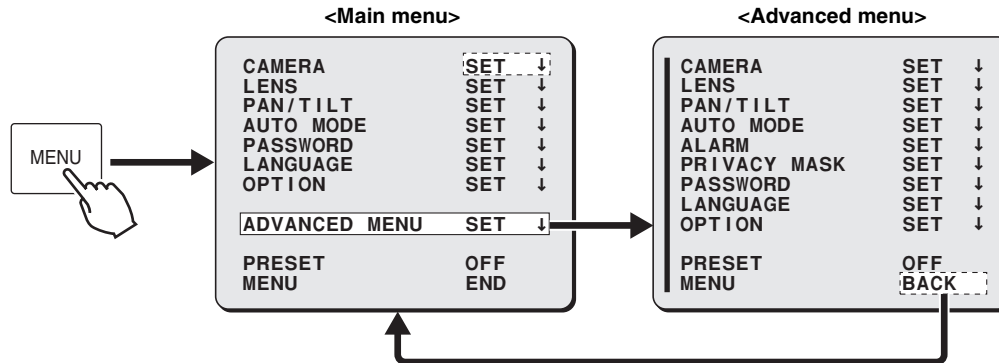

- Memo:**
- In the advanced menu, the vertical line is displayed on the left end of the screen.
 - The settings common to the main menu and advanced menu modes are shared regardless of the menu mode in which the settings are made. However, different passwords can be specified for the main menu and advanced menu respectively.

The description in this manual assumes the advanced menu.

Entering password

When the password lock is enabled, you have to enter your password before displaying the main menu by pressing the [MENU] button. To enter your password, perform the following procedures.

- 1 Use the joystick lever (←→) to select the digit and use the lever (↑↓) to select a number.**

The PASSWORD screen appears.

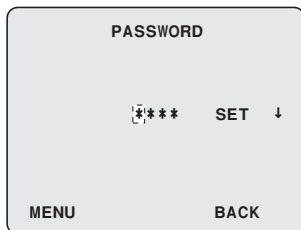

- 2 After entering your four-digit password, press [ENTER].**

If the password is authenticated, the menu screen appears.



- If an invalid password is entered, "NG" appears and the cursor moves to [BACK]. If you entered invalid password three consecutive times, the password entry field disappears.
- The factory setting value for password is "1234". To keep the camera system secured, change your password regularly.

About Setting Menus

Setting menu composition

The setting menu (ADVANCED MENU) contains the following settings.

The menu item shown with ↓ mark has an advanced setting screen.

| | | | |
|---|--------------|-----|------|
| ① | CAMERA | SET | ↓ |
| ② | LENS | SET | ↓ |
| ③ | PAN/TILT | SET | ↓ |
| ④ | AUTO MODE | SET | ↓ |
| ⑤ | ALARM | SET | ↓ |
| ⑥ | PRIVACY MASK | SET | ↓ |
| ⑦ | PASSWORD | SET | ↓ |
| ⑧ | LANGUAGE | SET | ↓ |
| ⑨ | OPTION | SET | ↓ |
| | PRESET MENU | OFF | BACK |

① Camera settings (CAMERA)

Performs camera shooting settings including synchronization, lens aperture, white balance, backlight compensation and electronic shutter.

| | | |
|---------------|------|---|
| SYNC | INT | ↓ |
| IRIS | AUTO | ↓ |
| WHITE BALANCE | ATW | ↓ |
| BLC | OFF | ↓ |
| SHUTTER | OFF | ↓ |
| APERTURE | ON | ↓ |
| AGC | ON | ↓ |
| GAMMA | 0.45 | ↓ |
| DAY/NIGHT | AUTO | ↓ |

P8

② Lens settings (LENS)

Performs settings for focus and zoom operations.

| | | |
|-------|------|---|
| LENS | | |
| FOCUS | AUTO | ↓ |
| ZOOM | SET | ↓ |

P22

③ Pan and tilt settings (PAN/TILT)

Performs panning and tilting settings including preset position setting.

| | | |
|------------------|-----|---|
| PAN/TILT SETTING | | |
| PRESET POSITION | SET | ↓ |
| PROPORTIONAL | ON | ↓ |
| FREEZE | OFF | ↓ |
| SET NORTH | OFF | ↓ |
| TILT LIMIT | 6 | ↓ |

P25

④ Auto mode settings (AUTO MODE)

Performs settings for four auto surveillance modes.

| | | |
|-------------|-------|---|
| AUTO MODE | | |
| SEQUENCE | A | ↓ |
| AUTO PAN | 1 | ↓ |
| TOUR | 1 | ↓ |
| AUTO RETURN | SEQ A | ↓ |
| TIME | 1M | ↓ |

P33

⑤ Alarm settings (ALARM)

Performs settings including alarm input/output (external input x 8, external output x 2) and motion sensor settings.

| | | |
|---------------|-----|---|
| ALARM | | |
| ALARM IN | 1 | ↓ |
| ALARM OUT | 1 | ↓ |
| ALARM DISABLE | OFF | ↓ |
| MOTION | OFF | ↓ |
| ALARM DISPLAY | OFF | ↓ |

P38

⑥ Privacy mask settings (PRIVACY MASK)

Specifies up to 24 privacy masks to protect privacy.

| | | |
|-----------------|-----|------|
| MASK NO. SELECT | | |
| MASK 1 | OFF | ↓ |
| MASK 2 | OFF | ↓ |
| MASK 3 | OFF | ↓ |
| MASK 4 | OFF | ↓ |
| MASK 5 | OFF | ↓ |
| MASK 6 | OFF | ↓ |
| MASK 7 | OFF | ↓ |
| MASK 8 | OFF | ↓ |
| PRESET MENU | OFF | BACK |

P44

⑦ Password settings (PASSWORD)

Performs settings for enabling/disabling password lock and changing password.

| | | |
|-----------------|-----|---|
| PASSWORD | | |
| PASSWORD LOCK | OFF | ↓ |
| PASSWORD CHANGE | SET | ↓ |

P45

⑧ Language settings (LANGUAGE)

Performs display language settings for menus.

| | | |
|----------|---------|---|
| LANGUAGE | | |
| LANGUAGE | ENGLISH | ↓ |
| LANGUE | FRENCH | ↓ |
| SPRACHE | GERMAN | ↓ |

P47

⑨ Miscellaneous settings (OPTION)

Performs settings for optional functions including auto flip, sway correction, auto pursuit and mirroring according to your preferences.

| | | |
|--------------|-----|---|
| OPTION | | |
| INFORMATION | SET | ↓ |
| AUTO FLIP | ON | ↓ |
| STABILIZER | OFF | ↓ |
| AUTO PURSUIT | OFF | ↓ |
| MIRROR | OFF | ↓ |
| REFRESH | SET | ↓ |

P48

Camera Settings (CAMERA)

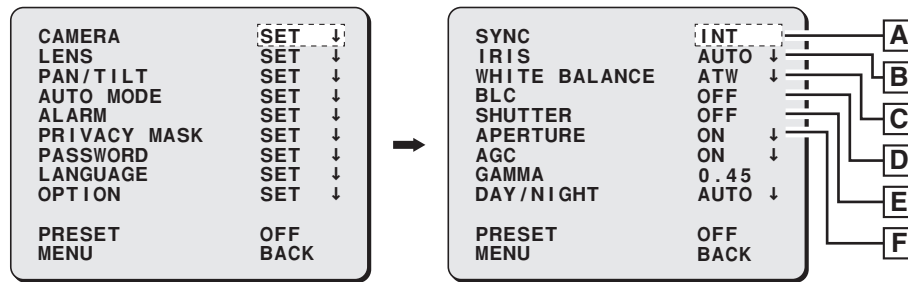

A Adjusting synchronization signal (SYNC)

Adjusts vertical synchronization signal for the camera.

- Internal synchronization (INT)
- Power source synchronization (L-L)

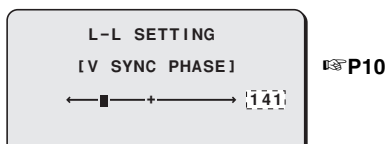

B Setting lens aperture (IRIS)

Sets lens aperture according to the luminance level of the target object.

- Auto iris (AUTO)
- Manual iris (MANU)

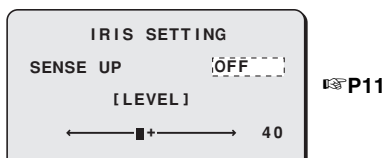

C Setting the white balance (WHITE BALANCE)

Sets the white balance according to the shooting conditions.

- Auto trace white balance (ATW)
- One-push automatic white balance (AWC)
- Fixed white balance (3200/5600/FLUO)
- Manual white balance (MWB)

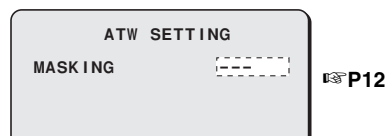

D Setting the backlight compensation level (BLC)

Sets the backlight compensation function to get clearer image in backlight condition.

- Multi-spot evaluative metering (MULT)
- Center-weighted average metering (CENT)
- Multi-spot metering (MASK)
- OFF

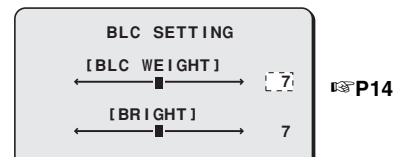

The multi-spot metering (MASK) function is available only when registering a view setting file in the CAMERA VIEW screen (P27).

E Setting the electronic shutter (SHUTTER)

Sets the appropriate shutter speed according to your surveillance purpose.

- Fast shutter speed (SHORT)
- Slow shutter speed (LONG)
- OFF

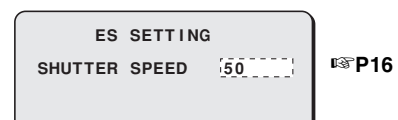

F Setting the profile compensation (APERTURE)

Adjusts the profile of the target object horizontally or vertically.

- ON ↓
- OFF

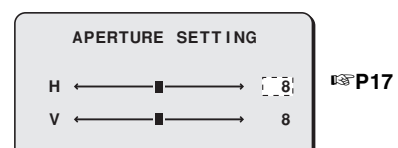

Camera Settings (CAMERA)

| | |
|---------------|----------|
| SYNC | INT |
| IRIS | AUTO ↓ |
| WHITE BALANCE | ATW ↓ |
| BLC | OFF |
| SHUTTER | OFF |
| APERTURE | ON ↓ |
| AGC | ON ↓ |
| GAMMA | 0.45 ↓ |
| DAY/NIGHT | AUTO ↓ |
| PRESET MENU | OFF BACK |



G Setting the AGC level (AGC)

Sets the AGC (Auto Gain Control) level in four grades.

- ON (four grades)
- OFF

| | |
|--------------|----------|
| GAIN SETTING | |
| MAX GAIN | NORMAL |
| DNR | OFF |
| PRESET MENU | OFF BACK |

P17

I Setting the Day/Night function (DAY/NIGHT)

Switches automatically between color mode and black and white mode depending on the luminance of the object being monitored.

- Enabling the Day/Night function (AUTO)
- Using the color mode only (COLOR)
- Using the black and white mode only (B/W)

| | |
|------------------|----------|
| D/N SETTING-AUTO | |
| LEVEL | MID |
| BURST | OFF |
| FOCUS | 2 |
| PRESET MENU | OFF BACK |

P19

H Setting the gamma correction level (GAMMA)

Sets the gamma correction level to adjust the contrast or brightness level in four grades.

| | |
|---------------|----------|
| SYNC | INT |
| IRIS | AUTO ↓ |
| WHITE BALANCE | ATW ↓ |
| BLC | OFF |
| SHUTTER | OFF |
| APERTURE | ON ↓ |
| AGC | ON ↓ |
| GAMMA | 0.45 ↓ |
| DAY/NIGHT | AUTO ↓ |
| PRESET MENU | OFF BACK |

P18

Camera Settings (CAMERA)

A Adjusting synchronization signal (SYNC)

The camera allows you to choose the synchronization signal adjustment method from the following options.

- Internal synchronization (INT) <Initial setting>
Uses internal signal in the camera to adjust synchronization.
- Power source synchronization (L-L)
Uses the power source frequency to adjust the vertical synchronization phase.

| | |
|---------------|--------|
| SYNC | [INT] |
| IRIS | AUTO ↓ |
| WHITE BALANCE | ATW ↓ |
| BLC | OFF |
| SHUTTER | OFF |
| APERTURE | ON ↓ |
| AGC | ON ↓ |
| GAMMA | 0.45 |
| DAY/NIGHT | AUTO ↓ |
| PRESET | OFF |
| MENU | BACK |

The internal synchronization (INT) is used as an initial setting. In this setting, the vertical synchronization tends to be unstable when multiple cameras are connected through the camera switcher and the camera to be monitored is switched. In this case, use the following steps to adjust the vertical synchronization phase.

- 1 Use the joystick lever (↓↑) to select [SYNC], use the lever (←→) to select "L-L", and press the [ENTER] button.

The L-L SETTING screen appears.

| | |
|---------------|--------|
| SYNC | [L-L] |
| IRIS | AUTO ↓ |
| WHITE BALANCE | ATW ↓ |
| BLC | OFF |
| SHUTTER | OFF |
| APERTURE | ON ↓ |
| AGC | ON ↓ |
| GAMMA | 0.45 |
| DAY/NIGHT | AUTO ↓ |
| PRESET | OFF |
| MENU | BACK |

| | |
|----------------|------|
| L-L SETTING | |
| [V SYNC PHASE] | |
| ← [] → [141] | |
| PRESET | OFF |
| MENU | BACK |

- 2 Use the joystick lever (←→) to adjust the value so that the image on the monitor does not move up and down when you use the camera switcher.

(Phase adjustment for vertical synchronization)

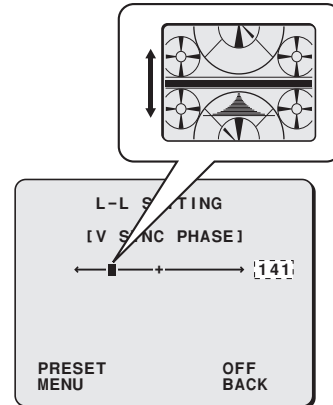

- After completing adjustment, use the lever to move the cursor to [MENU] and select "BACK" or "END".



Adjustment using power source synchronization is available only for the area where the power supply frequency is 50Hz. This setting will not work in the area where the power supply frequency is 60Hz.

Camera Settings (CAMERA)

B Setting lens aperture (IRIS)

Sets lens aperture according to the luminance level of the target object.

The following methods are available for setting lens aperture.

- Auto iris (AUTO) <Initial setting>
- Manual iris (MANU)

| | |
|---------------|--------|
| SYNC | INT |
| IRIS | AUTO ↓ |
| WHITE BALANCE | ATW ↓ |
| BLC | OFF |
| SHUTTER | OFF |
| APERTURE | ON ↓ |
| AGC | ON ↓ |
| GAMMA | 0.45 ↓ |
| DAY/NIGHT | AUTO ↓ |
| PRESET | OFF |
| MENU | BACK |

■ Auto iris (AUTO)

Automatic setting of lens aperture provides natural images even outdoors where the luminance difference is large, or in backlight conditions.

- 1 Use the joystick lever (↑↓) to select [IRIS], use the lever (←→) to select "AUTO", and press the [ENTER] button.

The IRIS SETTING screen appears.

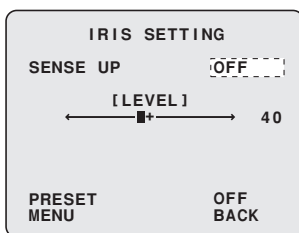

- 2 Use the joystick lever (↑↓) to select [SENSE UP] and use the lever (←→) to select magnification power of electronic sensitivity.

Available settings: OFF, X2, X4, X8, X16, X32

- 3 Use the joystick lever (↑↓) to select [LEVEL] and use the lever (←→) to adjust the iris level.

Available settings: 0 (dark) - 100 (bright)

After completing setting, use the lever to move the cursor to [MENU] and select "BACK" or "END".



- Electronic sensitivity boosting (SENSE UP) automatically lengthens the CCD exposure time in dark situations. Accordingly, moving target objects may cause conspicuous afterimages, blurs and white spots.
- When electronic sensitivity boosting (SENSE UP) is enabled, the electronic shutter function will not work.
- When the Day/Night function is set to "AUTO", electronic sensitivity boosting (SENSE UP) works only while black and white image is displayed.

■ Manual iris (MANU)

When the [IRIS] is set to "MANU", lens aperture can be set manually. Because activating the electronic iris disables the auto iris function, you need to set appropriate lens aperture using the following procedure.

- 1 Use the joystick lever (↑↓) to select [IRIS], use the lever (←→) to select "MANU", and press the [ENTER] button.

The IRIS SETTING screen appears.

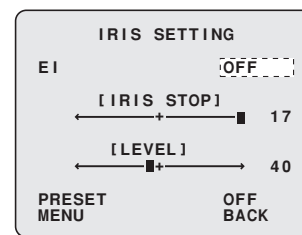

- 2 Use the joystick lever (↑↓) to select [EI] and use the lever (←→) to select "ON".

The electronic iris function controls both the AGC circuit and shutter speed to change exposure value.

- 3 Use the joystick lever (↑↓) to select [IRIS STOP] and use the lever (←→) to adjust the aperture opening value.

Selecting the value changes the lens aperture opening.

Available settings: 1 (close, darker) - 17 (open, brighter)

- 4 Use the joystick lever (↑↓) to select [LEVEL] and use the lever (←→) to adjust the iris level.

Available settings: 0 (video level is darker) - 100 (video level is brighter)

After completing setting, use the lever to move the cursor to [MENU] and select "BACK" or "END".



Notes on setting electronic iris (EI):

- If the iris views an unusually bright image, it can cause a smear that cannot be corrected by adjusting the light entering through the lens. In this case, arrange the physical angle of lighting in a way that will prevent on-screen smearing.
- If there is a fluorescent lighting in the camera location, flickering of the target object may occur. Changing fluorescent lighting to incandescent lighting will prevent the flickering.
- When the electronic iris (EI) is activated, the electronic shutter (SHUTTER) setting cannot be made.

Camera Settings (CAMERA)

■ One-push automatic white balance (AWC)

In one-push automatic white balance setting, adjust white balance for a fixed surveillance location by orienting the lens toward the white target object (ex. white wall or paper).

- 1 Use the joystick lever (↑↓) to select [WHITE BALANCE], use the lever (←→) to select "AWC ↓", and press the [ENTER] button.

The AWC SETTING screen appears.

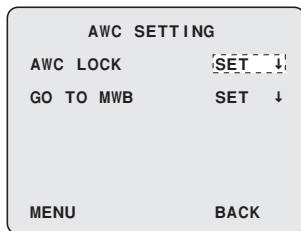

- 2 While "SET ↓" for [AWC LOCK] is highlighted, orient the lens toward the white target object and press the [ENTER] button.

After the highlighted "SET ↓" option temporarily returns to normal indication for about two seconds, the "SET ↓" option is highlighted again and the white balance adjustment completes.



If the result of white balance adjustment is unsatisfactory, press the [ENTER] button again while "SET ↓" is highlighted.

ⓘ After completing setting, use the lever to move the cursor to [MENU] and select "BACK" or "END".

Fine-tuning white balance setting (GO TO MWB)

If you want to fine-tune white balance setting after one-push automatic white balance adjustment completes, you can adjust white balance manually. To adjust white balance manually, use the joystick lever (↑↓) to select [GO TO MWB] – "SET ↓", and press the [ENTER] button.

The MWB SETTING screen appears.

For details on adjusting white balance manually, refer to the "Manual white balance (MWB)" section in the right column on this page.



You also can access the MWB SETTING screen directly by selecting "MWB ↓" in the [WHITE BALANCE] menu item. Whether you access the MWB SETTING screen directly or through the AWC SETTING screen, only one set of options and values in the MWB SETTING screen is stored as the manual white balance setting.

■ Fixed white balance (3200/5600/FLUO)

You can set the color temperature of white balance setting to a fixed value.

- 1 Use the joystick lever (↑↓) to select [WHITE BALANCE] and use the lever (←→) to select desired color temperature option.

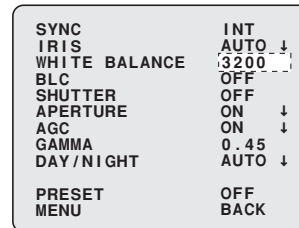

Available settings:

- **3200:** Color temperature of 3,200K (For indoor)
- **5600:** Color temperature of 5,600K (For outdoor)
- **FLUO:** Color temperature of 4,200K (For fluorescent lighting)

■ Manual white balance (MWB)

You can manually adjust white balance to your desired setting.

- 1 Use the joystick lever (↑↓) to select [WHITE BALANCE], use the lever (←→) to select "MWB ↓", and press the [ENTER] button.

The MWB SETTING screen appears.

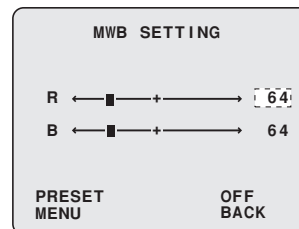

- 2 Use the joystick lever (↑↓) to select color and use the lever (←→) to adjust darkness level for the color.

Available settings: R (Red), B (Blue)

Available settings: 0 - 255 (The larger the number, the darker the color is.)

ⓘ After completing setting, use the lever to move the cursor to [MENU] and select "BACK" or "END".

Camera Settings (CAMERA)

D Setting the backlight compensation level (BLC)

Sets the backlight compensation function to get clearer image in backlight condition.

The following metering methods are available for the backlight compensation function.

- Multi-spot evaluative metering (MULT)
- Center-weighted average metering (CENT)
- Multi-spot metering (MASK)

| | |
|---------------|--------|
| SYNC | INT |
| IRIS | AUTO ↓ |
| WHITE BALANCE | ATW ↓ |
| BLC | MULT ↓ |
| SHUTTER | OFF ↓ |
| APERTURE | ON ↓ |
| AGC | ON ↓ |
| GAMMA | 0.45 ↓ |
| DAY/NIGHT | AUTO ↓ |
| PRESET | OFF |
| MENU | BACK |

!

- If you do not use the backlight compensation function, set [BLC] to "OFF".
- The multi-spot metering (MASK) function is available only when registering a view setting file in the CAMERA VIEW screen (P27).

Multi-spot evaluative metering (MULT)

Evaluates the entire screen and corrects according to the best image obtained.

- 1 Use the joystick lever (↑↓) to select [BLC], use the lever (←→) to select "MULT ↓", and press the [ENTER] button.**

The BLC SETTING screen appears.

| | |
|--------------|------|
| BLC SETTING | |
| [BLC WEIGHT] | 7 |
| [BRIGHT] | 7 |
| PRESET | OFF |
| MENU | BACK |

- 2 Use the joystick lever (↑↓) to select [BLC WEIGHT] and use the lever (←→) to select the value of "BLC WEIGHT".**

Available settings: 0 - 15 (The larger the number, the more backlighting works.)

- 3 Use the joystick lever (↑↓) to select [BRIGHT] and use the lever (←→) to adjust compensation level.**

Adjusts the compensation level for the brightness of the backlighting.

Available settings: 0 - 15 (The larger the number, the more it brightens.)

⏪ After completing setting, use the lever to move the cursor to [MENU] and select "BACK" or "END".

Center-weighted average metering (CENT)

Measures light mainly at the specified metering zone and compensates for brightness level according to the best image obtained.

- 1 Use the joystick lever (↑↓) to select [BLC], use the lever (←→) to select "CENT ↓", and press the [ENTER] button.**

The BLC SETTING (POSITION) screen appears.

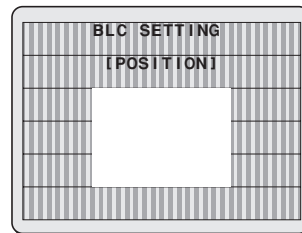

- 2 Use the joystick lever to determine the position for the center-weighted average metering zone, and press the [ENTER] button.**

The BLC SETTING (SIZE) screen appears.

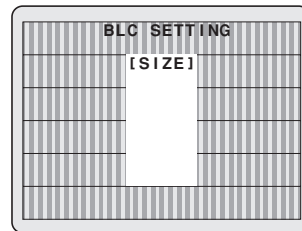

- 3 Use the joystick lever to determine the size of the center-weighted average metering zone, and press the [ENTER] button.**

The BLC WINDOW WEIGHTING screen appears.

| | |
|----------------------|------|
| BLC WINDOW WEIGHTING | |
| TOP | 0 |
| BOTTOM | 0 |
| LEFT | 0 |
| RIGHT | 0 |
| CENTER [FIX] | 7 |
| PRESET | OFF |
| MENU | BACK |

Camera Settings (CAMERA)

- 4** Use the joystick lever (↑↓) to select a zone to be weighted and use the lever (←→) to adjust weighting.

Selecting a zone to be weighted shows the corresponding zone on the screen.

- TOP
- LEFT
- CENTER [FIX] (The value is fixed to "7".)
- BOTTOM
- RIGHT

Available settings: 0 - 7 (The larger the number, the higher the weighting.)

After completing setting, use the lever to move the cursor to [MENU] and select "BACK" or "END".

Multi-spot metering (MASK)

Sets backlight compensation by masking the bright area of the background using mask patterns.



The multi-spot metering (MASK) function is available only when registering a view setting file in the CAMERA VIEW screen (P27). Set [MASKING] to "ON" in the MOTION SETTING screen.

- 1** Use the joystick lever (↑↓) to select [BLC], use the lever (←→) to select "MASK ↓", and press the [ENTER] button.

The BLC MASKING screen appears. A mask pattern is displayed in the top left of the screen.

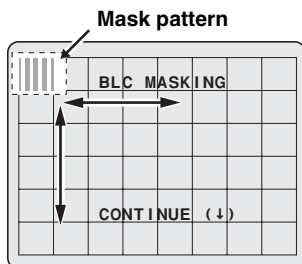

- 2** Use the joystick lever (↑↓ or ←→) to move a mask pattern to the area to be excluded in metering, and press the [ENTER] button.

This sets the mask pattern for the area to be excluded in metering.

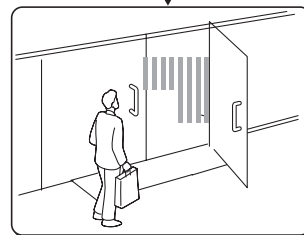
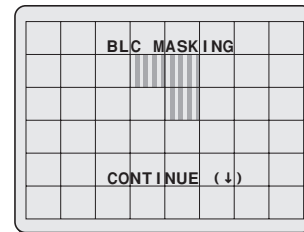

If you want additional mask patterns to be set, repeat the above procedure.

<To delete the mask pattern>

Use the joystick lever (↑↓ or ←→) to place a mask pattern over the mask pattern to be cancelled, then press the [ENTER] button.

- 3** Use the joystick lever (↓) to move a mask pattern to the bottom area of the screen and continue holding the lever straight down for three seconds.

This completes the mask pattern setting procedure.

After completing setting, use the lever to move the cursor to [MENU] and select "BACK" or "END".

Camera Settings (CAMERA)

E Setting the electronic shutter (SHUTTER)

Sets the appropriate shutter speed according to your surveillance purpose.

The following shutter speed modes are available.

- Fast shutter speed (SHORT)
- Slow shutter speed (LONG)

| | |
|---------------|---------|
| SYNC | INT |
| IRIS | AUTO ↓ |
| WHITE BALANCE | ATW ↓ |
| BLC | OFF |
| SHUTTER | SHORT ↓ |
| APERTURE | ON ↓ |
| AGC | ON ↓ |
| GAMMA | 0.45 |
| DAY/NIGHT | AUTO ↓ |
| PRESET | OFF |
| MENU | BACK |

If you do not use the electronic shutter, set [SHUTTER] to "OFF".



The electronic shutter cannot be set in the following conditions.

- For the auto iris setting, the electronic sensitivity setting is activated. (When the [IRIS] is set to "AUTO", [SENSE UP] in the IRIS SETTING screen is set to other than "OFF".)
- For the manual iris setting, the electronic iris is activated. (When the [IRIS] is set to "MANU", [EI] is set to "ON".)

Fast shutter speed (SHORT)

When viewing fast-moving target objects, higher shutter speed produces clearer images with less blurs.

- 1** Use the joystick lever (↑↓) to select [SHUTTER], use the lever (←→) to select "SHORT ↓", and press the [ENTER] button.

The ES SETTING screen appears.

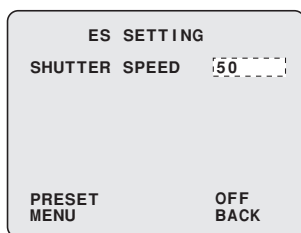

- 2** Use the joystick lever (←→) to select the desired shutter speed.

Available settings: 50, 120, 250, 500, 1000, 2000, 4000, 10000 (1/N sec.)



To avoid flicker
If the camera is installed under fluorescent lighting and the power supply frequency is 60Hz, set the shutter speed to "120 (1/120 sec)" to avoid flicker.

After completing setting, use the lever to move the cursor to [MENU] and select "BACK" or "END".

Slow shutter speed (LONG)

When the target object is in dark condition, making the exposure time longer increases sensitivity, enabling you to view target object more brightly. Select desired shutter speed according to the shooting conditions.

The initial setting for slow shutter speed (LONG) is "x1".

- 1** Use the joystick lever (↑↓) to select [SHUTTER], use the lever (←→) to select "LONG ↓", and press the [ENTER] button.

The ES SETTING screen appears.

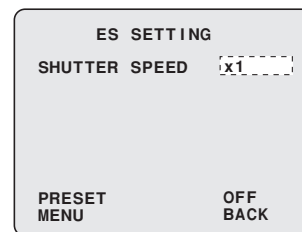

- 2** Use the joystick lever (←→) to select the desired shutter speed.

Available settings: x1, x2, x4, x8, x16, x32

(Each option represents a multiple of field time. The higher the number, the longer the exposure time.)



When the exposure time is longer, moving objects may cause conspicuous afterimages, blurs and white spots.

After completing setting, use the lever to move the cursor to [MENU] and select "BACK" or "END".

Camera Settings (CAMERA)

F Setting the profile compensation (APERTURE)

Further emphasizes the profile of the target object. The amount of compensation can be adjusted for the horizontal or vertical directions.

| | |
|---------------|--------|
| SYNC | INT |
| IRIS | AUTO ↓ |
| WHITE BALANCE | ATW ↓ |
| BLC | OFF |
| SHUTTER | OFF |
| APERTURE | OFF ↓ |
| AGC | ON ↓ |
| GAMMA | 0.45 ↓ |
| DAY/NIGHT | AUTO ↓ |
| PRESET | OFF |
| MENU | BACK |

- 1 Use the joystick lever (↑↓) to select [APERTURE], use the lever (←→) to select "ON ↓", and press the [ENTER] button.

The APERTURE SETTING screen appears.

| | |
|------------------|-----------|
| APERTURE SETTING | |
| H | ← [] → 8 |
| V | ← [] → 8 |
| PRESET | OFF |
| MENU | BACK |

Available settings:

- OFF: The profile compensation is turned off.
- ON: The profile compensation is turned on.

- 2 Use the joystick lever (←→) to adjust the value for "H" (horizontal).

Available settings: 1 - 15 (The higher the number, the further the profile is emphasized.)

- 3 Use the joystick lever (↑↓) to move the cursor to "V" (vertical), and use the lever (←→) to adjust the value for "V".

Available settings: 1 - 15 (The higher the number, the further the profile is emphasized.)

After completing adjustment, use the lever to move the cursor to [MENU] and select "BACK" or "END".

G Setting the AGC level (AGC)

Sets the AGC (Auto Gain Control) level in four grades.

| | |
|---------------|--------|
| SYNC | INT |
| IRIS | AUTO ↓ |
| WHITE BALANCE | ATW ↓ |
| BLC | OFF |
| SHUTTER | OFF |
| APERTURE | ON ↓ |
| AGC | ON ↓ |
| GAMMA | 0.45 ↓ |
| DAY/NIGHT | AUTO ↓ |

If you do not use the AGC function, set [AGC] to "OFF".

Setting AGC

- 1 Use the joystick lever (↑↓) to select [AGC], use the lever (←→) to select "ON ↓", and press the [ENTER] button.

The GAIN SETTING screen appears.

| | |
|--------------|--------|
| GAIN SETTING | |
| MAX GAIN | NORMAL |
| DNR | OFF |

Memo: Auto Gain Control (AGC) is a function that automatically adjusts gain level in the amplifier section for the camera's video signal according to the brightness of the target object and keeps the signal output level constant. When the target object is bright, the gain level is decreased; when it is dark, the level is increased.

- 2 Use the joystick lever (↑↓) to select [MAX GAIN] and use the lever (←→) to adjust AGC level.

Available settings:

- NORMAL: Initial setting
- MIDDLE: For dark target object
- HIGH: For very dark target object
- LOW: For bright target object

Memo:

- The "LOW" option cannot be selected when the Day/Night function is set to "AUTO".
- The value for the "MAX GAIN" setting depends on the Day/Night function mode.
- When the gain level is increased, the sensitivity is improved in dark condition, but the noise level increases.

- 3 Use the joystick lever (↑↓) to select [DNR] and use the lever (←→) to select a DNR (Digital Noise Reduction) option.

Available settings:

- ON: Applies DNR. (Reduces noise during low luminance level.)
- OFF: Does not apply DNR.



Digital noise reduction operates when the gain level increases. In addition, blurring and ghosting of images can occur when moving images are monitored, so the resolution is also reduced slightly. When the waver correction (STABILIZER) or electronic zoom is operating in the color mode, the DNR (Digital Noise Reduction) does not function.

After completing setting, use the lever to move the cursor to [MENU] and select "BACK" or "END".

Camera Settings (CAMERA)

Setting the AGC level manually

When the AGC function is set to "OFF", the gain level for camera's video signal can be specified manually.

- 1 Use the joystick lever (↑↓) to select [AGC], use the lever (←→) to select "OFF", and press the [ENTER] button.

The GAIN SETTING screen appears.

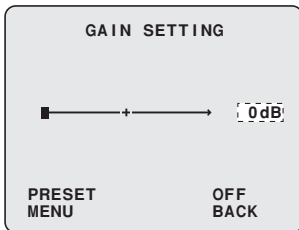

- 2 Use the joystick lever (←→) to select the gain level value.

Available settings: 0 - 30dB (The higher the number, the more the gain level is increased.)



- When the Day/Night function is set to "AUTO", the AGC function cannot be set to "OFF".
- The "AGC" can be set to "OFF" only when [SENSE UP] in the IRIS SETTING screen is set to "OFF".

☞ After completing setting, use the lever to move the cursor to [MENU] and select "BACK" or "END".

H Setting the gamma correction level (GAMMA)

Sets the gamma correction level to adjust the contrast or brightness level in four grades.

| | |
|---------------|--------|
| SYNC | INT |
| IRIS | AUTO ↓ |
| WHITE BALANCE | ATW ↓ |
| BLC | OFF ↓ |
| SHUTTER | OFF ↓ |
| APERTURE | ON ↓ |
| AGC | ON ↓ |
| GAMMA | 0.45 ↓ |
| DAY/NIGHT | AUTO ↓ |
| PRESET MENU | OFF |
| | BACK |

- 1 Use the joystick lever (↑↓) to select [GAMMA] and use the lever (←→) to adjust the gamma correction level.

Available settings:

- 0.45: $\gamma = 0.45$
- 1: $\gamma = 1$
- MODE1: Increases the contrast of the dark parts.
- MODE2: Further increases the contrast of the dark parts.



When "MODE1" or "MODE2" is selected, the image can be too bright depending on the target object.

☞ After completing setting, use the lever to move the cursor to [MENU] and select "BACK" or "END".

Camera Settings (CAMERA)

I Setting the Day/Night function (DAY/NIGHT)

(For VCC-MC800P only)

Switches automatically between color mode and black and white mode depending on the luminance of the object being monitored. This function lets you set the filming mode to color mode during times of normal brightness like daytime or to black and white mode during times of darkness like night.

- Enabling the Day/Night function (AUTO)
- Using the color mode only (COLOR)
- Using the black and white mode only (B/W)

| | |
|---------------|--------|
| SYNC | INT |
| IRIS | AUTO ↓ |
| WHITE BALANCE | ATW ↓ |
| BLC | OFF |
| SHUTTER | OFF |
| APERTURE | ON ↓ |
| AGC | ON ↓ |
| GAMMA | 0.45 ↓ |
| DAY/NIGHT | AUTO ↓ |
| PRESET | OFF |
| MENU | BACK |

Memo: You can also use the [AUX] button on the system controller to switch the Day/Night function mode.

| Day/Night function mode | Sub screen | Number entry screen |
|-------------------------|------------|---------------------|
| AUTO | AUX ON | 3 |
| B/W | AUX ON | 2 |
| COLOR | AUX ON | 1 |



- A sound from the camera may be heard when the color image or black and white image is switched. Also, the image will be distorted as shown in the figure below. This is normal and does not indicate a problem.

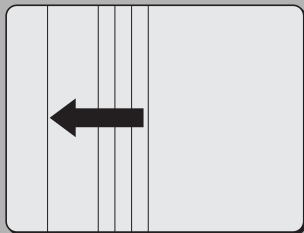

- If the power is turned off in the black and white mode and the power is turned on again, the color mode will be used. The focused position may be differently adjusted between the color mode and the black and white mode. Adjust focusing so that the focused position matches between the color mode and the black and white mode.
- When using infrared lighting in black and white mode, if there is a strong reflection on the subject, the black and white mode may switch to color mode. Use only enough infrared lighting so that the mode is not switched.

■ Setting the Day/Night function (AUTO)

This function automatically switches between the color mode and the black and white mode according to the luminance of the target object. The color mode is used for daytime; the black and white mode is used for night.

- 1 Use the joystick lever (↑↓) to select [DAY/NIGHT], use the lever (←→) to select "AUTO ↓", and press the [ENTER] button.

The D/N SETTING-AUTO screen appears.

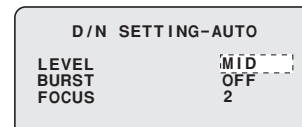

- 2 Use the joystick lever (↑↓) to select [LEVEL], use the lever (←→) to select a luminance level where the viewing mode between the color mode and black and white mode is switched, and press the [ENTER] button.

Available settings:

- **MID:** The mode switches when the luminance of the objects being monitored is between the "LOW" and "HIGH" levels.
- **HIGH:** The mode switches when the luminance of the objects being monitored is comparatively bright (the black and white mode is used longer).
- **ADJ↓:** Sets the switching luminance level manually. When you select "ADJ↓", the LEVEL SETTING screen appears allowing you to perform manual settings for the switching luminance level.
- **LOW:** The mode switches when the luminance of the objects being monitored is comparatively dark (the color mode is used longer).

<The LEVEL SETTING screen under the "ADJ" option>

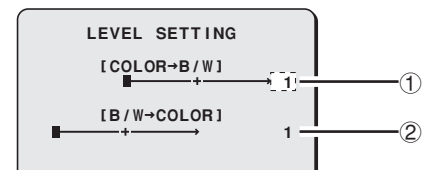

- ① **COLOR → B/W**
Sets the luminance level for switching from the color mode to the black and white mode.
Available settings: 1 - 7 (The larger the value, the darker the switching luminance level.)
- ② **B/W → COLOR**
Sets the luminance level for switching from the black and white mode to the color mode.
Available settings: 1 - 7 (The larger the value, the brighter the switching luminance level.)

- Memo:**
- In the "ADJ" setting, changing the setting for one of the switching level settings (from color mode to black and white mode or from black and white mode to color mode) causes the other setting to change also.
 - Increasing the luminance level difference avoids hunting under IR (infrared) lighting.

Camera Settings (CAMERA)

3 Use the joystick lever (↑↓) to select [BURST] and use the lever (←→) to select "ON/OFF".

If the camera is connected to peripheral devices like frame switcher, burst may occur when the viewing mode is switched between the color mode and the black and white mode. In this case, compensate for the image by inserting the color burst signals.

In general, set this option to "OFF".

Available settings:

- **ON:** The color burst signal is turned on.
- **OFF:** The color burst signal is turned off.

4 Use the joystick lever (↑↓) to select [FOCUS] and use the lever (←→) to select the focus compensation mode.

In general, set this option to "2". If images are out of focus, set this option to "1".

Available settings:

- **1:** Near-infrared wavelength correction (around 900nm) is set during the black and white mode.
- **2:** Visible light spectrum is set during the color mode.

☞ After completing setting, use the lever to move the cursor to [MENU] and select "BACK" or "END".



While the Day/Night function is set to "AUTO", the following applies.

- Multi-spot evaluative metering (MULT) selected in the backlight compensation level (BLC) setting works during the color mode.
- The electronic sensitivity boosting (SENSE UP) selected in the lens aperture (IRIS) setting works during the black and white mode.
- The AGC function cannot be set to "OFF".

Using the color mode only (COLOR)

Regardless of the luminance level, only use the color mode to view the image.

1 Use the joystick lever (↑↓) to select [DAY/NIGHT], use the lever (←→) to select "COLOR ↓", and press the [ENTER] button.

The D/N SETTING-COLOR screen appears.

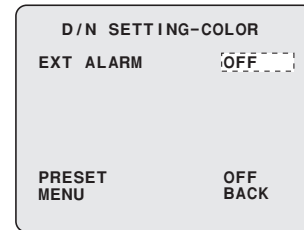

2 Use the joystick lever (↑↓) to select [EXT ALARM] and use the lever (←→) to select the channel used for external alarm input.

When [EXT ALARM] is set to "1" - "8", receiving external alarm input automatically switches the color mode to the black and white mode.

Available settings:

- **OFF:** Does not switch the color mode to the black and white mode when receiving external alarm input.
- **1-8:** Switches the color mode to the black and white mode when receiving external alarm input. (Select an input channel used for external alarm input.)

☞ After completing setting, use the lever to move the cursor to [MENU] and select "BACK" or "END".

Camera Settings (CAMERA)

■ Using the black and white mode only (B/W)

Regardless of the luminance level, only use the black and white mode to view the image.

- 1** Use the joystick lever (↑↓) to select [DAY/NIGHT], use the lever (←→) to select “B/W ↓”, and press the [ENTER] button.

The D/N SETTING-B/W screen appears.

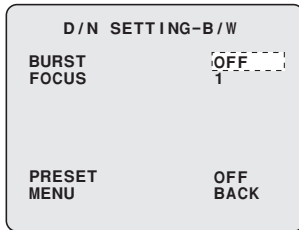

- 2** Use the joystick lever (↑↓) to select [BURST] and use the lever (←→) to select “ON/OFF”.

Sets whether the color burst signal is turned on or off. In general, set this option to “OFF”.

Available settings:

- **ON:** The color burst signal is turned on.
- **OFF:** The color burst signal is turned off.

- 3** Use the joystick lever (↑↓) to select [FOCUS] and use the lever (←→) to select focus compensation mode.

In general, set this option to “1”. If images are out of focus, set this option to “2”.

Available settings:

- **1:** Near-infrared wavelength correction (around 900nm) is set during the black and white mode.
- **2:** Visible light spectrum is set during the color mode.

☞ After completing setting, use the lever to move the cursor to [MENU] and select “BACK” or “END”.

Lens Settings (LENS)

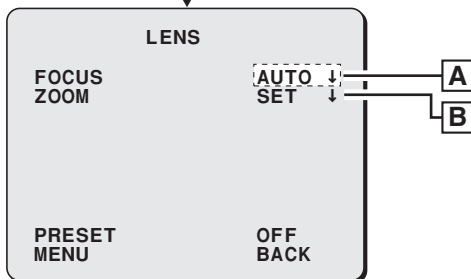
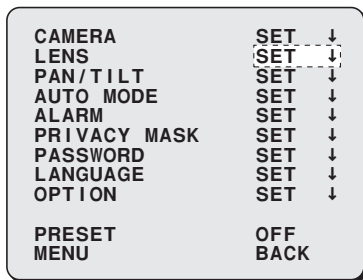

A Setting the focusing mode (FOCUS)

You can select the focusing mode from the following options.

- Auto focus (AUTO)
- Manual focus (MANU)

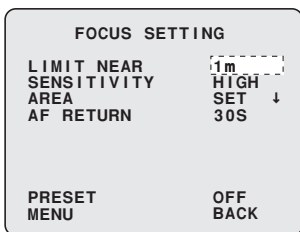

B Setting the zooming operations (ZOOM)

For zooming operations, you can set the zooming speed and electronic zooming options.

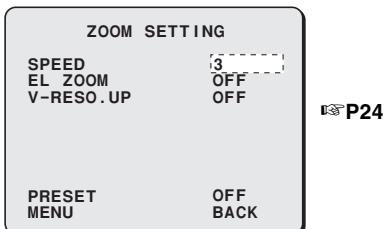

A Setting the focusing mode (FOCUS)

You can select the focusing mode from the following two options.

- Auto focus (AUTO)
- Manual focus (MANU)

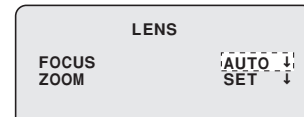

Auto focus (AUTO)

Performs settings for the auto focus function.

Using the auto focus function in surveillance for longer hours shortens the life of the lens unit. If performing surveillance for an extended period (24 hours or more), you are recommended to use manual focus.

- 1 Use the joystick lever (↑↓) to select [FOCUS], use the lever (←→) to select "AUTO ↓", and press the [ENTER] button.

The FOCUS SETTING screen appears.

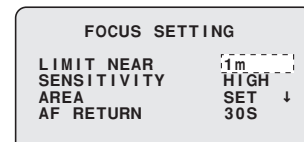

- 2 Use the joystick lever (↑↓) to select [LIMIT NEAR] and use the lever (←→) to select the nearest focusing distance to the target object.

Available settings: 10cm, 30cm, 50cm, 1m, 3m, 5m

When the distance to the target object is less than or equal to 1m, focusing may become difficult.

- 3 Use the joystick lever (↑↓) to select [SENSITIVITY] and use the lever (←→) to select sensitivity in focusing.

Available settings:

- HIGH: High sensitivity focusing
- LOW: Low sensitivity focusing

When focusing sensitivity is set to "HIGH", the camera may react to even slight movements of the target object. In this case, change the setting to "LOW".

Lens Settings (LENS)

4 Use the joystick lever (↑↓) to select [AREA] – “SET↓”, and press the [ENTER] button.

The AREA SETTING screen appears.

In [AREA], select the area used for auto focusing.

Available settings:

- 1 (full screen)

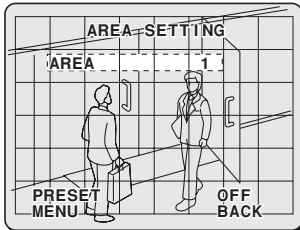

- 2 (center of screen: initial setting)

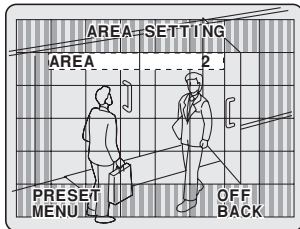

- 3 (smaller center)

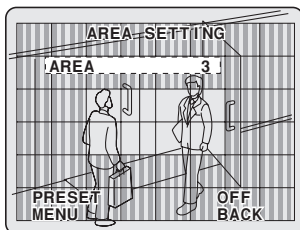

Setting the auto focus auto return function (AF RETURN)

When [FOCUS] is set to “AUTO” in the LENS screen, this function automatically restores the focusing mode to the auto focus mode (AUTO) after manual focus (MANU) operations are completed.

Use the joystick lever (↑↓) to select [AF RETURN] and use the lever (←→) to select time for switching automatically from manual focusing to auto focusing.

Available settings:

- **AUTO:** When an operation other than manual focusing is performed, the focusing mode returns to the auto focus mode.
- **20S, 30S, 40S, 50S, 1M, 2M, 3M, 4M, 5M**
(S: Second, M: Minute): Returns the focusing mode to the auto focus mode after the duration selected in this option has passed.

☞ After completing setting, use the lever to move the cursor to [MENU] and select “BACK” or “END”.

Manual focus (MANU)

Sets the nearest focusing distance to the target object and the focusing speed while performing manual focusing.



When the distance to the target object is less than or equal to 1m, focusing may become difficult.

1 Use the joystick lever (↑↓) to select [FOCUS], use the lever (←→) to select “MANU ↓”, and press the [ENTER] button.

The FOCUS SETTING screen appears.

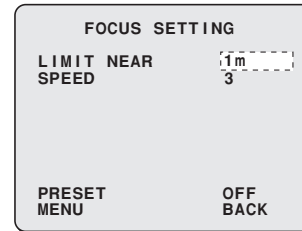

2 Use the joystick lever (↑↓) to select [LIMIT NEAR] and use the lever (←→) to select the nearest focusing distance to the target object.

Available settings: 10cm, 30cm, 50cm, 1m, 3m, 5m

3 Use the joystick lever (↑↓) to select [SPEED] and use the lever (←→) to select the focusing speed.

Available settings: 1, 2, 3, 4 (The larger the value, the faster the focusing speed.)

☞ After completing setting, use the lever to move the cursor to [MENU] and select “BACK” or “END”.

Lens Settings (LENS)

B Setting the zooming operations (ZOOM)

You can select zooming speed to target object and magnification power of electronic zoom.

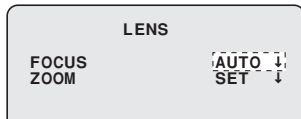

- 1 Use the joystick lever (↑↓) to select [ZOOM] – “SET ↓”, and press the [ENTER] button.

The ZOOM SETTING screen appears.

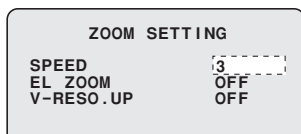

- 2 Use the joystick lever (↑↓) to select [SPEED] and use the lever (←→) to select zooming speed.

Available settings: 1, 2, 3, 4 (The larger the value, the faster the zooming speed.)

- 3 Use the joystick lever (↑↓) to select [EL ZOOM] and use the lever (←→) to select magnification power of electronic zoom.

The electronic zooming activates when an zooming operation goes beyond the maximum magnification power of optical zoom.

Available settings: OFF (Electronic zoom is turned off.)
x2, x4, x8, x16

- 4 Use the joystick lever (↑↓) to select [V-RESO.UP] and use the lever (←→) to select a vertical resolution.

Available settings:

- **ON:** Improves vertical resolution while using the electronic zoom.
- **OFF:** Does not improve vertical resolution while using the electronic zoom.

Memo: When the vertical resolution improvement is set to “ON”, moving target objects will cause conspicuous afterimages and blurs.

After completing setting, use the lever to move the cursor to [MENU] and select “BACK” or “END”.



In the following condition, the vertical resolution improvement (V-RESO.UP) will be set to “OFF” automatically.

- When the electronic sensitivity setting (SENSE UP) is set to “ON” in the auto iris setting (AUTO).
- When the electronic shutter setting (SHUTTER) is set to “LONG” (Slow shutter speed mode).
- When the digital noise reduction setting (DNR) is set to “ON” in the auto gain control setting (AGC).

Pan and Tilt Settings (PAN/TILT)

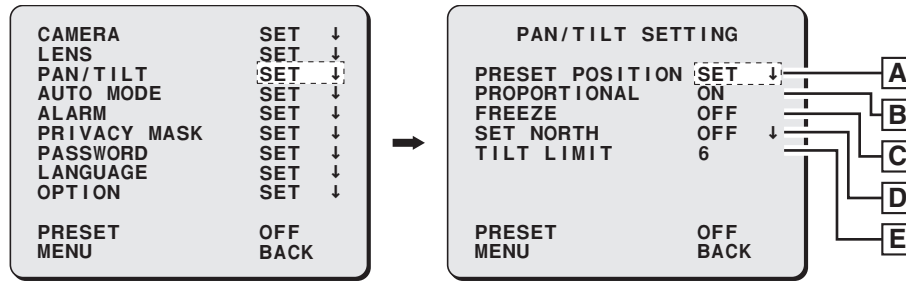

A Registering a surveillance location (PRESET POSITION)

Pan and tilt settings such as camera's orientation can be registered as preset positions. Preset positions can be grouped and individual preset position groups can be used for Sequence mode.

| PRESET NO. | SELECT |
|------------|----------------|
| 1: A | 11:- 21:- 31:- |
| 2:- | 12:- 22:- 32:- |
| 3:- | 13:- 23:- 33:- |
| 4:- | 14:- 24:- 34:- |
| 5:- | 15:- 25:- 35:- |
| 6:- | 16:- 26:- 36:- |
| 7:- | 17:- 27:- 37:- |
| 8:- | 18:- 28:- 38:- |
| 9:- | 19:- 29:- 39:- |
| 10:- | 20:- 30:- 40:- |
| MENU | BACK |

P26

(Preset map screen)



Selecting a preset number displays the screen for selecting preset options.

| PRESET NO. 001 | POSITION | SET |
|----------------|-------------|------|
| | TITLE | OFF |
| | CAMERA VIEW | OFF |
| | HOLD | OFF |
| | SEQUENCE | |
| | GROUP | A |
| | PAUSE TIME | 5S |
| | PRESET GO | SET |
| | MENU | BACK |

P26

(Preset setting screen)



Selecting [CAMERA VIEW] displays the CAMERA VIEW screen used for configuring the camera view setting file.

| CAMERA VIEW 1 | MOTION | OFF |
|---------------|---------------|------|
| | IRIS | AUTO |
| | WHITE BALANCE | ATW |
| | BLC | OFF |
| | SHUTTER | OFF |
| | APERTURE | ON |
| | AGC | ON |
| | GAMMA | 0.45 |
| | DAY/NIGHT | AUTO |
| | PRESET | OFF |
| | MENU | BACK |

P27

(CAMERA VIEW screen)

B Making the amount of movement in the screen constant (PROPORTIONAL)

You can make the amount of movement in the screen constant by changing the moving speed of the camera during manual operation according to the zoom magnification power.

| PAN/TILT SETTING | PRESET POSITION | SET |
|------------------|-----------------|------|
| | PROPORTIONAL | ON |
| | FREEZE | OFF |
| | SET NORTH | OFF |
| | TILT LIMIT | 6 |
| | PRESET MENU | OFF |
| | | BACK |

P31

C Displaying a still image while switching the surveillance location (FREEZE)

The still image can be used in the screen while switching to other preset position.

| PAN/TILT SETTING | PRESET POSITION | SET |
|------------------|-----------------|------|
| | PROPORTIONAL | ON |
| | FREEZE | ON |
| | SET NORTH | OFF |
| | TILT LIMIT | 6 |
| | PRESET MENU | OFF |
| | | BACK |

P31

D Setting the starting point (0 degrees) angle information (SET NORTH)

You can set the starting point (0 degrees) angle for the camera by orienting it to your desired direction and saving the direction information.

| PAN/TILT SETTING | PRESET POSITION | SET |
|------------------|-----------------|------|
| | PROPORTIONAL | ON |
| | FREEZE | OFF |
| | SET NORTH | SET |
| | TILT LIMIT | 6 |
| | PRESET MENU | OFF |
| | | BACK |

P31

E Limiting the tilting angle (TILT LIMIT)

You can limit the tilting angle of the camera to your desired value.

| PAN/TILT SETTING | PRESET POSITION | SET |
|------------------|-----------------|------|
| | PROPORTIONAL | ON |
| | FREEZE | OFF |
| | SET NORTH | OFF |
| | TILT LIMIT | 6 |
| | PRESET MENU | OFF |
| | | BACK |

P32

Pan and Tilt Settings (PAN/TILT)

A Registering a surveillance location (PRESET POSITION)

When registering the surveillance location as preset position, you can change orientation of the camera by selecting the preset number.

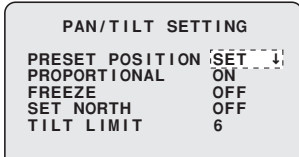

Determining the surveillance position (POSITION)

When determining the surveillance location, set the setting for the auto flip function in the OPTION screen to "OFF". If this function is set to "ON", the surveillance location may deviate from your setting. If the surveillance location deviates, you are required to determine the location again.

- 1 Use the joystick lever (↑↓) to select [PRESET POSITION] – “SET ↓”, and press the [ENTER] button.

The preset map screen appears.

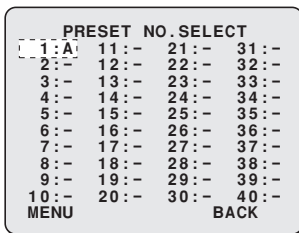

To select a preset number to register the camera's orientation:

- Use the joystick lever (↑↓ or ←→) to move the cursor to a preset number used for registration.
- Available preset numbers are 1 to 255.
- Preset numbers can be displayed up to 40 in one page. Moving the cursor to the leftmost or rightmost of the screen and continuing to press the joystick lever to the left or right changes the screen to the previous or next page.
 - Pressing to the right: Displays next page.
 - Pressing to the left: Displays previous page.

- 2 Use the joystick lever (↑↓) to select a preset number to register the camera's orientation, and press the [ENTER] button.

The preset setting screen appears.

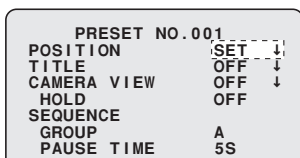

- The preset number 1 is used as home position and cannot be deleted. Initial setting is registered with preset number 0. When resetting the camera, the setting registered with the preset number 0 is also used for the preset number 1.
- The preset number 0 is not available for user-defined settings.

- 3 Use the joystick lever (↑↓) to select [POSITION] – “SET ↓”, and press the [ENTER] button.
The screen for determining the surveillance location appears.

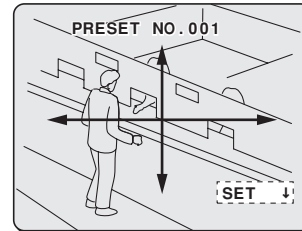

- 4 Use the joystick lever to determine the surveillance location, and press the [ENTER] button.
This sets the surveillance location and displays the preset setting screen again.

Specifying the camera ID and title

When you connect multiple cameras to the surveillance system, specify the camera ID for identifying individual cameras. You also can set a specific title to preset position for easier management.

- 1 Use the joystick lever (↑↓) to select [PRESET POSITION] – “SET ↓”, and press the [ENTER] button.

The preset map screen appears.

- 2 Use the joystick lever (↑↓) to select a preset number to specify the ID or title, and press the [ENTER] button.

The preset setting screen appears.

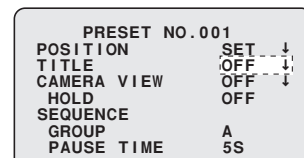

- 3 Use the joystick lever (↑↓) to select [TITLE], use the lever (←→) to select “ON ↓”, and press the [ENTER] button.

Available settings:

- OFF: Does not specify the camera ID and title.
- ON: Specifies the camera ID and title.
(The TITLE SETTING screen appears.)

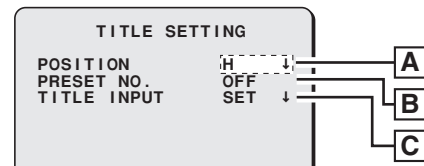

Pan and Tilt Settings (PAN/TILT)

A Selecting the display format and position (POSITION)

- Use the joystick lever (↑↓) to select [POSITION], use the lever (←→) to select the display format ("H" or "V"), and press the [ENTER] button.

Available settings:

- H:** The camera ID and title are displayed in a horizontal line.
- V:** The camera ID and title are displayed in a vertical line.

- While checking the monitor screen, use the joystick lever to determine the display position, and press the [ENTER] button.

The TITLE SETTING screen appears again.

B Setting whether to display the preset number or not (PRESET NO)

Use the joystick lever (↑↓) to select [PRESET NO] and use the lever (←→) to select "ON/OFF".

Available settings:

- OFF:** Does not display the preset number on the screen.
- ON:** Displays the preset number to the left of or above the camera ID and title.

C Entering the camera ID and title (TITLE INPUT)

Use the joystick lever (↑↓) to select [TITLE INPUT] – "SET ↓", and press the [ENTER] button.

The screen for entering the camera title appears.

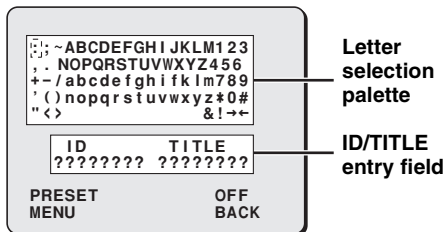

Example: To specify "CAM1" for the ID and "FLOOR" for the title:

- Use the joystick lever to move the cursor to the first place of the ID entry field.

- Use the joystick lever to move the cursor to "C" in the letter selection palette, and press the [ENTER] button. "C" appears in the first place of the ID entry field.

Use the same procedure shown above to enter "A", "M" and "1".

- Use the joystick lever to move the cursor to the first place of the title entry field, use the lever to move the cursor to "F" in the letter selection palette, and press the [ENTER] button.

Use the same procedure shown above to enter "L", "O", "O" and "R".

<Canceling the camera ID or title>

Use the joystick lever (↑↓) to select [PRESET], use the lever (←→) to select "ON ↓", and press the [ENTER] button. All the letters entered for the ID and title return to "?".

Memo:

- The camera ID can be set only for the preset number 1. The camera ID set for the preset number 1 will automatically be applied for preset number 2 and after.
- To display the camera ID and title on the screen, set [CAMERA ID] and [TITLE] in the [DISPLAY] screen under the INFORMATION screen to "ON".

Registering a view setting file (CAMERA VIEW)

To support shooting in various surveillance conditions like when the surveillance location is bright (or dark), the CAMERA VIEW screen allows you to register up to 8 patterns of shooting settings as camera view setting files. Specify the applied view setting file to each preset number.

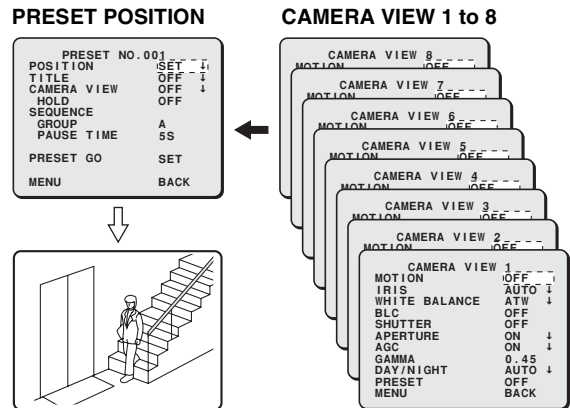

- Use the joystick lever (↑↓) to select [PRESET POSITION] – "SET ↓", and press the [ENTER] button.

The preset map screen appears.

- Use the joystick lever (↑↓) to select a preset number to register a view setting file, and press the [ENTER] button.

The preset setting screen appears.

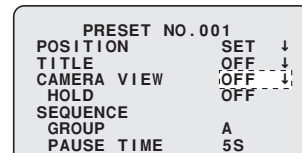

About the HOLD function

When setting [HOLD] to "ON", the settings for [CAMERA VIEW] is retained even when pan/tilt operations are performed at preset positions.

Moving to a preset position (PRESET GO) or performing operations in the Auto mode disables the HOLD function.

- Use the joystick lever (↑↓) to select [CAMERA VIEW], use the lever (←→) to select the number of the view setting file, and press the [ENTER] button.

Available settings:

- OFF:** OFF (Does not register view setting files.)
- 1 - 8:** Registers a view setting file. (The CAMERA VIEW screen appears.)

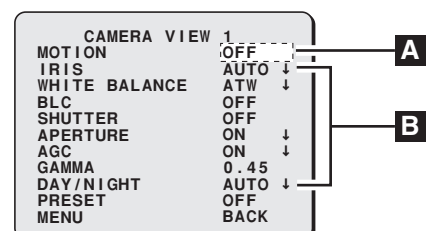

Pan and Tilt Settings (PAN/TILT)

A Setting the motion sensor (MOTION)

The built-in motion sensor will work for preset positions, allowing the camera to detect movements in the target object such as an intruder.

Use the joystick lever (↑↓) to select [MOTION], use the lever (←→) to select "ON ↓", and press the [ENTER] button.

Available settings:

- **OFF:** Disables the motion sensor.
- **ON:** Enables the motion sensor.
(The MOTION SETTING screen appears.)



Before performing the settings under [MOTION], be sure to set [MOTION] in the ALARM screen to "PRESET". When [MOTION] is set to options other than "PRESET", "----" displays for [MOTION] in the CAMERA VIEW screen and settings cannot be made.

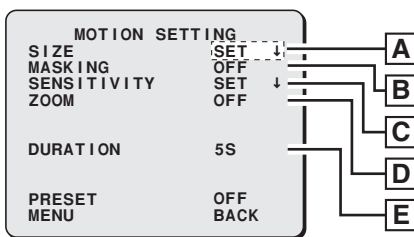

A Setting the size of the motion sensor (SIZE)

Set the detection pattern according to the size of the target object to be detected for alarm. A movement in the target object will be detected within the area where the detection pattern is specified.

- 1 Use the joystick lever (↑↓) to select [SIZE] – "SET ↓", and press the [ENTER] button.

The MOTION SIZE screen appears displaying the detection pattern (V1/H1) in the center of the screen.

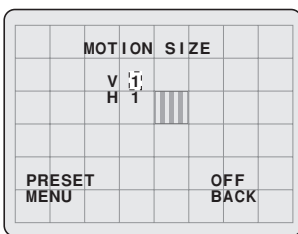

- 2 Use the joystick lever to adjust the values for "V" and "H" settings.

The size of the detection pattern will change depending on the values set for "V" and "H".

- **V:** 1 - 6 (Sets the size for vertical direction.)
- **H:** 1 - 8 (Sets the size for horizontal direction.)

Memo: The maximum value for "V x H" is 9. When setting "V" or "H" and the multiplied value exceeds the maximum value, the other value will automatically be adjusted so that the value for "V x H" does not exceed 9.

B Setting the mask patterns for the area to be excluded in motion detection (MASKING)

If you have an area where you don't want to detect motion in the target object (swaying trees, flickering of light, etc.), you can set the mask pattern over the area so that the motion sensor does not react to it.

- 1 Use the joystick lever (↑↓) to select [MASKING], use the lever (←→) to select "ON ↓", and press the [ENTER] button. The MOTION MASKING screen appears. A mask pattern is displayed in the top left of the screen.

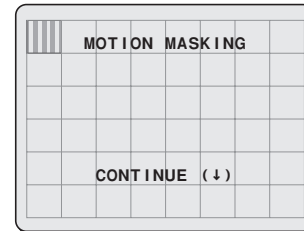

- 2 Use the joystick lever to move the mask pattern to the area where you don't want to detect motion, and press the [ENTER] button.

This sets one mask pattern for the area to be excluded in detecting. If you want additional mask patterns to be set, repeat the above procedure.

<To delete the mask pattern>

Use the joystick lever (↑↓ or ←→) to place a mask pattern over the mask pattern to be cancelled, then press the [ENTER] button.

- 3 Use the joystick lever (↓) to move a mask pattern to the bottom area of the screen and continue holding the lever straight down for three seconds.

This completes the mask pattern setting procedure.

C Setting the detection sensitivity (SENSITIVITY)

You can set the level of sensitivity for motion detection. Adjusting the level of sensitivity avoids unwanted detection.

- 1 Use the joystick lever (↑↓) to select [SENSITIVITY] – "SET ↓", and press the [ENTER] button.

The SENSITIVITY screen appears.

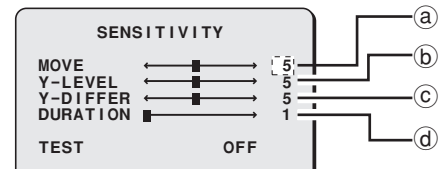

- 2 Set the detection level for the following parameters.

For all parameters, the larger the value, the lower the sensitivity.

- Motion sensitivity (MOVE):** 1 - 10
To avoid detection of small movements, make the value larger.
- Brightness level (Y-LEVEL):** 1 - 10
When noise from a dark screen is causing erroneous detections, make the value larger.
- Brightness differences (Y-DIFFER):** 1 - 10
To avoid detection of lights turning on and off, make the value larger.
- Duration (DURATION):** 1 - 60
To avoid detection of fast movements, make the value larger.

- 3 To test the sensitivity settings, use the joystick lever (↑↓) to select [TEST] and use the lever (←→) to select "ON". When a motion is detected, patterns are shown in that location. Adjust the setting values as necessary.

Pan and Tilt Settings (PAN/TILT)

D Setting zooming operation options (ZOOM)

When a motion is detected, the camera zooms in and out automatically.

- 1 Use the joystick lever (↑↓) to select [ZOOM] and use the lever (←→) to select zooming mode.

Available settings:

- **OFF:** Disables the auto zooming. (Initial setting)
- **IN:** Performs detection at the center of the screen and zooms in along the optical axis.
- **OUT:** Performs detection over the full screen (except for the masked area) and zooms out along the optical axis.
- **IN-MOV:** Performs detection over the full screen (except for the masked area) and zooms in at the position where motion was detected.

- 2 Select the optical zoom magnification power (RATIO) according to the zooming mode you selected.

Available settings:

- **IN:** x1.4, x2, x2.8, x4, x5.6, x8, FULL (zooming in to the TELE end), MANU (manual setting)
- **OUT:** x1/1.4, x1/2, x1/2.8, x1/4, x1/5.6, x1/8, FULL (zooming out to the WIDE end), MANU (manual setting)
- **IN-MOV:** x1.4, x2, x2.8, x4, x5.6, x8, FULL (zooming in to the TELE end), MANU (manual setting)

Memo: When selecting "MANU", the RATIO SETTING screen appears. While monitoring the actual image and performing zooming operation, specify the zoom magnification power, then press the [ENTER] button. The zoom magnification power value appears in the bottom left of the screen.

- 3 Select the duration for the zooming operation (TIME)

Available settings: (common to all zooming modes)

5S, 10S, 15S, 20S, 30S, 45S, 1M, 2M, 3M, 4M, 5M (S: Second, M: Minute)



The value you can select here should be within the duration specified in the [DURATION] setting (see step E below).

E Setting the interval after which the next alarm becomes in effect (DURATION)

When a motion is detected and an alarm signal is output, another alarm signal will not be output until the duration specified in this setting has passed.

Use the joystick lever (↑↓) to select [DURATION] and use the lever (←→) to select the interval after which the next alarm becomes in effect.

Available settings: 5S, 10S, 15S, 20S, 30S, 45S, 1M, 2M, 3M, 4M, 5M (S: Second, M: Minute)

B Setting related options other than motion sensor

The following settings are common to the ones performed in the camera and lens settings. See their respective reference pages.

- **IRIS** (Page 11)
- **WHITE BALANCE** (Page 12)
- **BLC** (Page 14)
- **SHUTTER** (Page 16)
- **APERTURE** (Page 17)
- **AGC** (Page 17)
- **GAMMA** (Page 18)
- **DAY/NIGHT** (Page 19)

Memo: The IRIS, SHUTTER and MOTION functions can be used in the combination shown in the table below.

| | | | | | | |
|---------|---------------------|---|---|---|---|---|
| IRIS | AUTO: SENSE UP (ON) | ○ | × | × | × | × |
| | MANU: EI (ON) | × | ○ | × | × | ◎ |
| SHUTTER | LONG | × | × | ○ | × | × |
| | SHORT | × | × | × | ○ | ◎ |
| MOTION | | × | ◎ | × | ◎ | ○ |

○: Function is set ×: Not allowable ◎: Allowable

- : When exiting individual menu, settings will be cancelled.

After completing setting, use the lever to move the cursor to [MENU] and select "BACK" or "END".

Grouping the preset positions (SEQUENCE GROUP)

Each preset position can be assigned to a group (A to D). The group can be used for the Sequence mode to monitor multiple surveillance locations sequentially.

| PRESET NO. SELECT | | | |
|-------------------|-------|-------|-------|
| 1: A | 11: B | 21: - | 31: - |
| 2: B | 12: - | 22: B | 32: - |
| 3: - | 13: - | 23: - | 33: - |
| 4: A | 14: - | 24: - | 34: - |
| 5: - | 15: A | 25: - | 35: - |
| 6: - | 16: - | 26: - | 36: - |
| 7: - | 17: - | 27: A | 37: - |
| 8: A | 18: - | 28: - | 38: - |
| 9: - | 19: - | 29: - | 39: - |
| 10: - | 20: B | 30: B | 40: - |
| MENU | | BACK | |

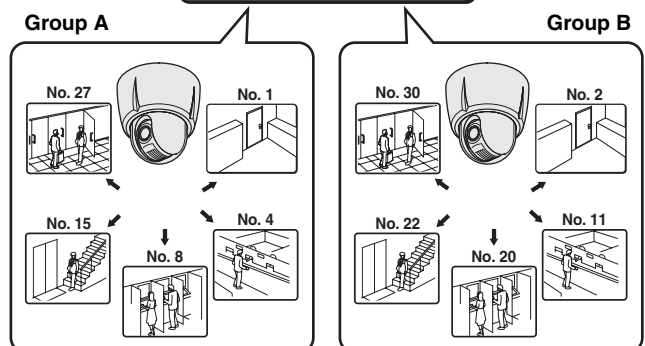

- 1 Use the joystick lever (↑↓) to select [PRESET POSITION] – "SET ↓", and press the [ENTER] button.

The preset map screen appears.

Pan and Tilt Settings (PAN/TILT)

- Use the joystick lever (↑↓) to select a preset number to assign to a group, and press the [ENTER] button.

The preset setting screen appears.

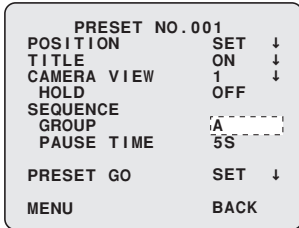

- Use the joystick lever (↑↓) to select [SEQUENCE GROUP] and use the lever (←→) to select a group to assign the preset number.

Available settings:

- *: Does not assign to a group. (Registers the preset number only.)
- A, B, C, D: Assigns a preset number to the group you selected. Assigned group is shown in the preset map screen.

- Use the joystick lever (↑↓) to select [PAUSE TIME] and use the lever (←→) to select the pause duration for sequential panning operation.

Available settings:

3S, 4S, 5S, 6S, 7S, 8S, 9S, 10S, 15S, 20S, 30S, 45S, 1M (S: Second, M: Minute)

After completing setting, use the lever to move the cursor to [MENU] and select "BACK" or "END".

Deleting a preset position (DELETE)

The preset number "1" cannot be deleted.

- Use the joystick lever (↑↓) to select [PRESET POSITION] – "SET ↓", and press the [ENTER] button.

The preset map screen appears.

- Use the joystick lever (↑↓) to select a preset number to delete, and press the [ENTER] button.

The preset setting screen appears.

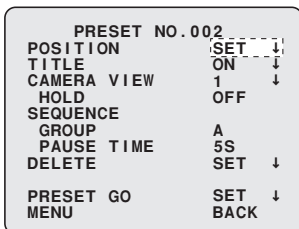

- Use the joystick lever (↑↓) to select [DELETE] – "SET ↓", and press the [ENTER] button.

"OK? ↓" appears under "SET ↓".

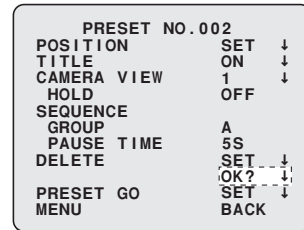

- Use the joystick lever (↑↓) to select "OK?", and press the [ENTER] button.

The preset position you selected is deleted and the indication in the preset map screen changes to "-".

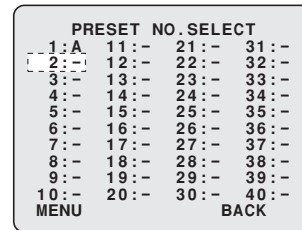

Switching to a preset position (PRESET GO)

You can switch the surveillance location to a preset position by using the following procedure.

- Use the joystick lever (↑↓) to select [PRESET POSITION] – "SET ↓", and press the [ENTER] button.

The preset map screen appears.

- Use the joystick lever (↑↓) to select a preset number, and press the [ENTER] button.

The preset setting screen appears.

When a preset position is registered, the surveillance location moves to the preset position.

- Use the joystick lever (↑↓) to select [PRESET GO] – "SET ↓", and press the [ENTER] button.

The menu screen closes with the surveillance position being at the preset position.

Pan and Tilt Settings (PAN/TILT)

B Making the amount of movement in the screen constant (PROPORTIONAL)

The proportional function allows you to make the amount of movement in the screen constant by changing pan/tilt operation speed during manual operation according to the zoom magnification power.

- 1 Use the joystick lever (↑↓) to select [PROPORTIONAL] and use the lever (←→) to select "ON".

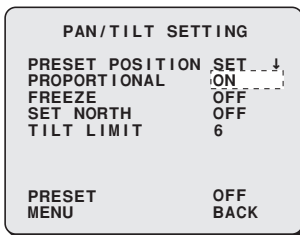

Available settings:

- **OFF:** Disables the proportional function.
- **ON:** Enables the proportional function.

After completing setting, use the lever to move the cursor to [MENU] and select "BACK" or "END".

C Displaying a still image while switching the surveillance location (FREEZE)

While the surveillance location moves by the Sequence mode or manual preset (PRESET GO) operations, the freeze function displays the still image immediately before the camera starts moving. After movement of the surveillance location completes, the still image is switched to the video image of the new surveillance location.

- 1 Use the joystick lever (↑↓) to select [FREEZE] and use the lever (←→) to select "ON".

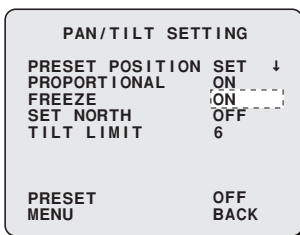

Available settings:

- **OFF:** Disables the freeze function.
- **ON:** Enables the freeze function.

After completing setting, use the lever to move the cursor to [MENU] and select "BACK" or "END".

D Setting the starting point (0 degrees) angle information (SET NORTH)

When you install the camera and the starting point (0 degrees) angle information for the camera needs to be specified, set the angle information using the following procedure. You can set any direction as the starting point (0 degrees) indicating north direction.

- 1 Use the joystick lever to orient the camera in the direction you want to set as the starting point.
- 2 Use the joystick lever (↑↓) to select [SET NORTH], use the lever (←→) to select "SET", and press the [ENTER] button.

When "SET" in the [SET NORTH] menu item changes to "ON", the starting point (0 degrees) setting completes.

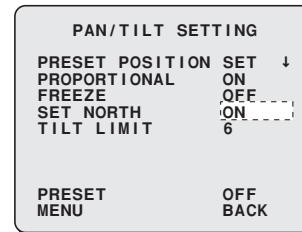

Available settings:

- **OFF:** Does not set the starting point angle information.
- **ON:** Sets the starting point angle information.
- **SET:** Setting operation is in progress. Determine the camera's orientation, then press the [ENTER] button. This completes the setting and "SET" changes to "ON".

After completing setting, use the lever to move the cursor to [MENU] and select "BACK" or "END".

- The camera rotates clockwise. North is regarded as 0 degrees. For example, 90 degrees represent east.
- To display the camera's angle information, set [DIRECTION] in the DISPLAY screen under the INFORMATION screen to "ON".

Pan and Tilt Settings (PAN/TILT)

E Limiting the tilting angle (TILT LIMIT)

When the tilting limit angle is not explicitly specified, the limit of tilting is -5 degrees to horizontal 0 degrees. If necessary, you can select the tilting limit angle using the following procedure. By setting the limit angle, the camera cannot be oriented to the direction beyond the limit angle.

- 1 Use the joystick lever (↑↓) to select [TILT LIMIT] and use the lever (←→) to select the tilting limit angle.

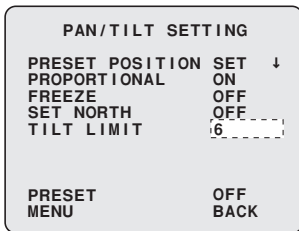

Available settings:

- **OFF:** Disables the TILT LIMIT function.
- **-2, 0, 2, 4, 6, 8, 10, 12, 14, 16, 18, 20, 22:** Sets the selected value as the tilting limit angle.
- **MANU:** Sets the tilting limit angle manually. (While "MANU" is selected, pressing the [ENTER] button displays the setting screen. Monitoring the live image, use the joystick lever to determine the tilting limit angle, then press the [ENTER] button.)



There is a parting line around zero degree position on the dome cover. Depending on the setting of tilting limit angle, the parting line may come into the camera's view and could adversely affect the focusing behavior.

- After completing setting, use the lever to move the cursor to [MENU] and select "BACK" or "END".

Auto Mode Settings (AUTO MODE)

The Auto mode can be used to operate the camera automatically to monitor multiple surveillance locations. There are four types of automatic panning available in Auto mode: Sequence mode (SEQUENCE), Tour mode (TOUR), Auto Pan mode (AUTO PAN) and Auto Return (AUTO RETURN).

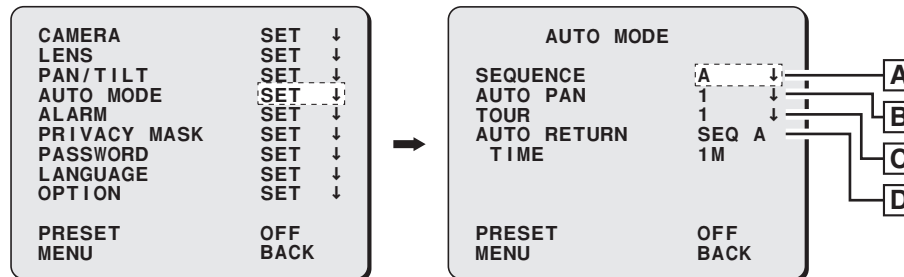

A Monitoring multiple preset positions sequentially (SEQUENCE)

The Sequence mode allows you to monitor multiple preset positions sequentially by using the sequence group containing preset positions.

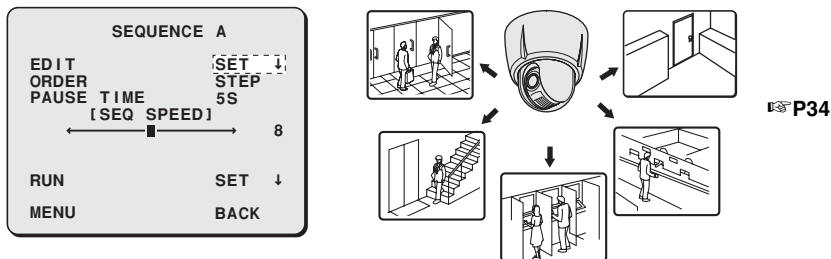

B Panning between two surveillance locations in loop (AUTO PAN)

The Auto Pan mode allows you to pan between two surveillance locations in loop. In this mode, you set a start point, an end point, moving speed, panning direction and other options.

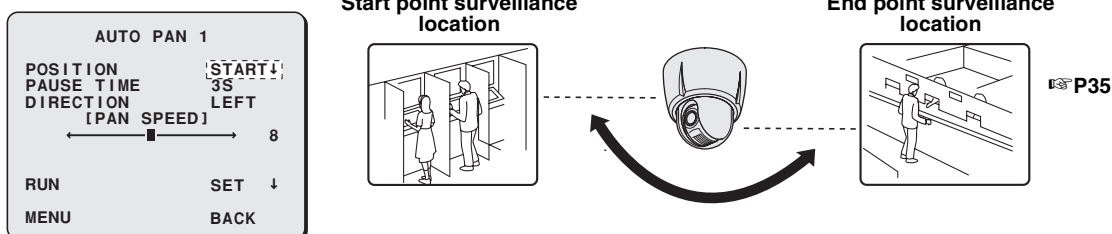

C Repeating a recorded monitoring process (TOUR)

You can repeat a monitoring process by recording an image track of all camera pan, tilt and zoom operations.

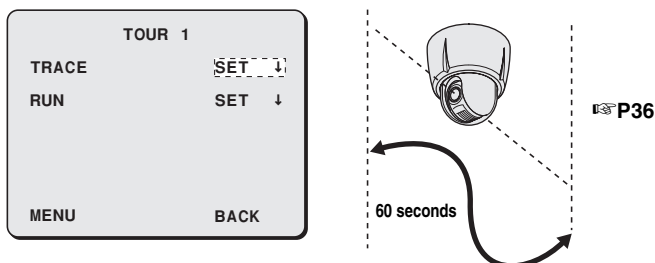

D Returning automatically to the specified surveillance mode (AUTO RETURN)

You can automatically return the surveillance status to the specified surveillance mode after the specified duration has passed without any operations. (P37)

Auto Mode Settings (AUTO MODE)

A Monitoring multiple preset positions sequentially (SEQUENCE)

The Sequence mode allows you to monitor multiple preset positions sequentially by using the sequence group containing preset positions. You can create up to four sequence groups.

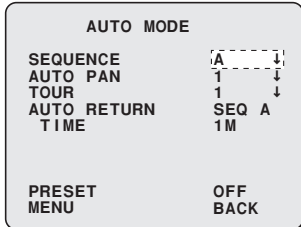

1 Create a sequence group by adding preset positions.

The preset positions you want to monitor in the Sequence mode should be added to the same group.

2 Use the joystick lever (↑↓) to select [SEQUENCE], use the lever (←→) to select a group (A to D) to monitor in the Sequence mode, and press the [ENTER] button.

The SEQUENCE screen appears.

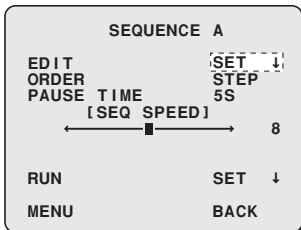

3 To review the surveillance locations, use the joystick lever (↑↓) to select [EDIT] – “SET ↓”, and press the [ENTER] button.

The preset map screen appears.

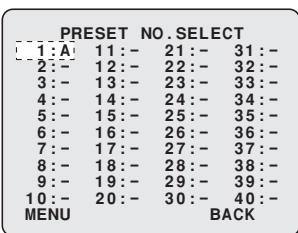

Confirm the sequence group indication for each preset number, and edit the group if necessary.

Use the joystick lever (↑↓) to select [MENU], and with “BACK” displayed, press the [ENTER] button. The SEQUENCE screen in step 2 above appears again.

4 Use the joystick lever (↑↓) to select [ORDER] and use the lever (←→) to select the sequence option.

Available settings:

- **STEP:** Monitors the preset positions in the order of their numbers.
- **RANDOM:** Monitors the preset positions in the sequence group randomly.

5 Use the joystick lever (↑↓) to select [PAUSE TIME] and use the lever (←→) to select the duration for which the camera pauses at each preset position.

Available settings: 3S, 4S, 5S, 6S, 7S, 8S, 9S, 10S, 15S, 20S, 30S, 45S, 1M, PRE (S: Second, M: Minute)

When selecting “PRE”, the pause duration set in the [PAUSE TIME] setting for each preset position is applied.

6 Use the joystick lever (↑↓) to select [SEQ SPEED] and use the lever (←→) to select the speed in which the camera moves between individual preset positions.

Available settings: 1 (slow) - 15 (fast)

7 Use the joystick lever (↑↓) to select [RUN] – “SET ↓”, and press the [ENTER] button.

The on-screen menu disappears, and the Sequence mode operation starts.

Pressing the [ENTER] button stops the operation.

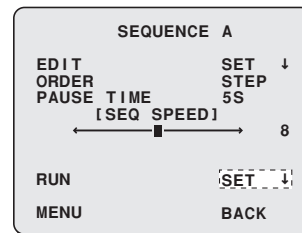

Memo: While monitoring in the normal screen, the Auto mode is turned on or off in the main screen of the system controller. For details, refer to the system controller instruction manual.

Auto Mode Settings (AUTO MODE)

B Panning between two surveillance locations in loop (AUTO PAN)

The Auto Pan mode allows you to pan between two surveillance locations in loop. In this mode, you set a start point, an end point, moving speed, panning direction and other options. You can create up to four Auto Pan groups.

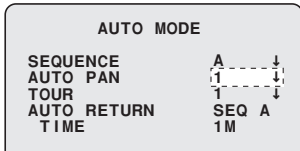

- 1 Use the joystick lever (↑↓) to select [AUTO PAN], use the lever (←→) to select an Auto Pan group number (1 - 4), and press the [ENTER] button.

The AUTO PAN screen appears.

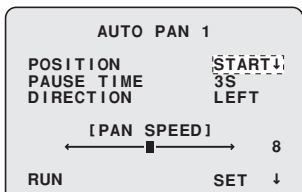

- 2 Use the joystick lever (↑↓) to select [POSITION], use the lever (←→) to select "START ↓" (start point), and press the [ENTER] button.

The START SETTING screen appears.

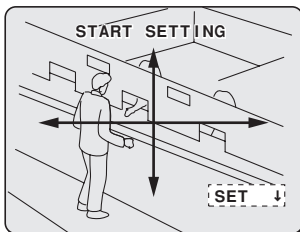

- 3 Use the joystick lever to determine a start point position of the Auto Pan mode operation, and press the [ENTER] button.

The AUTO PAN screen appears again.

- 4 Use the lever (←→) to select "END ↓" (end point), and press the [ENTER] button.

The END SETTING screen appears.

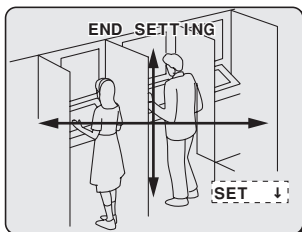

- 5 Use the joystick lever to determine an end point position of the Auto Pan mode operation, and press the [ENTER] button.

The AUTO PAN screen appears again.

Memo: When a start point and an end point are set to the same position, the camera rotates through 360 degrees repeatedly with the same tilting angle. The rotating direction is determined by the [DIRECTION] setting.

- 6 Use the joystick lever (↑↓) to select [PAUSE TIME] and use the lever (←→) to select the duration for which the camera pauses at the start and end positions.

Available settings: 1S, 2S, 3S, 4S, 5S, 10S, 20S, 30S (S: Second, M: Minute)

- 7 Use the joystick lever (↑↓) to select [DIRECTION] and use the lever (←→) to select the rotating direction during panning operation.

Available settings: RIGHT (rotates clockwise), LEFT (rotates counterclockwise)

- 8 Use the joystick lever (↑↓) to select [PAN SPEED] and use the lever (←→) to select the speed in which the camera moves between the start and end points.

Available settings: 1 (slow) - 15 (fast)

- 9 Use the joystick lever (↑↓) to select [RUN] – "SET ↓", and press the [ENTER] button.

The on-screen menu disappears, and the Auto Pan mode operation starts.

Pressing the [ENTER] button stops the operation.

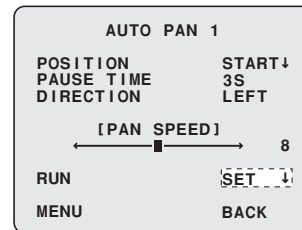

Memo: While monitoring in the normal screen, the Auto mode is turned on or off in the main screen of the system controller. For details, refer to the system controller instruction manual.



While the camera operates in the Auto Pan mode, the auto focus function is disabled. In this case, the focusing mode is switched to the manual focus mode and the focus is fixed to the position set in the START SETTING screen.

However, when the panning speed is very slow or the camera pauses at the start/end point for five seconds or longer, the auto focus function is activated.

Auto Mode Settings (AUTO MODE)

C Repeating a recorded monitoring process (TOUR)

You can repeat a monitoring process by recording an image track of all camera pan, tilt and zoom operations. You can create up to four image tracks.

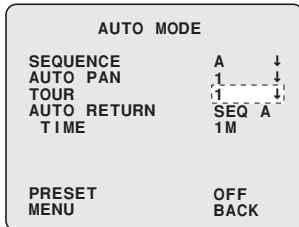

- 1 Use the joystick lever (↑↓) to select [TOUR], use the lever (←→) to select a number assigned to image track (1 - 4), and press the [ENTER] button.

The TOUR screen appears.

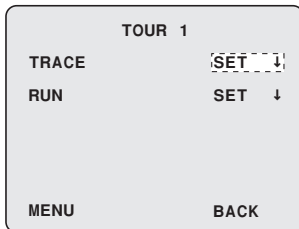

- 2 Use the joystick lever (↑↓) to select [TRACE] – “SET ↓”, and press the [ENTER] button.

“OK?” appears under “SET ↓”.

- 3 Use the joystick lever (↑↓) to select “OK?”, and press the [ENTER] button.

The TOUR SETTING screen appears, the "REC ↓" indication is displayed in the right bottom corner of the screen, and storing of the movement track and the operation sequence starts.

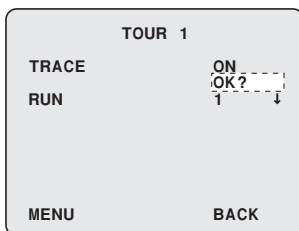

- 4 Operate the camera.

Every camera operation including panning, tilting and command operation will be recorded in sequence as tour memory.

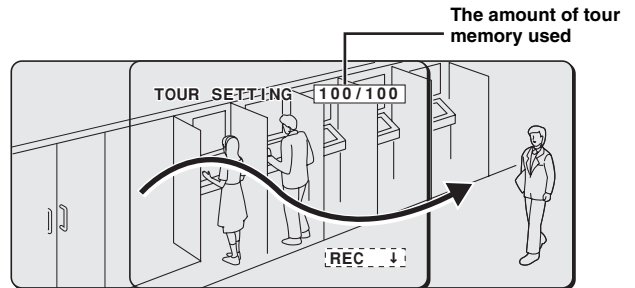

Recordable operations/commands:

panning, tilting, move to preset position (PRESET GO), zooming, one-push auto focus

Memo: The used amount of tour memory is displayed in the screen. The memory usage display starts from “0/100” and ends at “100/100” representing the memory is full.

- 5 After the operations to be recorded complete, press the [ENTER] button.

The operations performed are recorded as tour memory, and the TOUR screen appears again.

If the memory becomes full, the recording stops automatically at that moment.

- 6 Use the joystick lever (↑↓) to select [RUN] – “SET ↓”, and press the [ENTER] button.

The on-screen menu disappears, and the operation recorded in the tour memory will be repeated.

Pressing the [ENTER] button stops the operation.

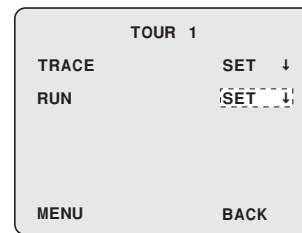

Memo: While monitoring in the normal screen, the Auto mode is turned on or off in the main screen of the system controller. For details, refer to the system controller instruction manual.

Auto Mode Settings (AUTO MODE)

Returning automatically to the D specified surveillance mode (AUTO RETURN)

You can automatically return the surveillance status to the specified surveillance mode, including the Auto mode and move to preset position, after the specified duration has passed without any operations.

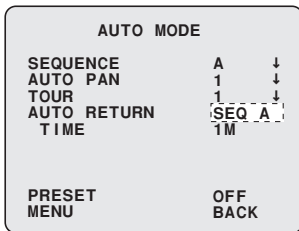

Memo: When the AUTO RETURN function has already been enabled, you can turn on or off the function by using the system controller. Press the [AUX ON] or [AUX OFF] button, and select "4" in the number entry screen.

1 Use the joystick lever (↑↓) to select [AUTO RETURN] and use the lever (←→) to select the surveillance mode to return to automatically.

Available settings:

- **OFF:** Disables the AUTO RETURN function.
- **SEQ A - D:** Sequence mode (A - D)
- **PAN 1 - 4:** Auto Pan mode (1 - 4)
- **TOUR 1 - 4:** Tour mode (1 - 4)
- **PRESET:** Preset position (1 - 255)
- **PREV.:** Returns to the original surveillance mode.

2 When you select "PRESET" in step 1, use the joystick lever (↓) to select [PRESET-], and use the lever (←→) to select a preset number.

The preset number selection field is displayed only when "PRESET" is selected.

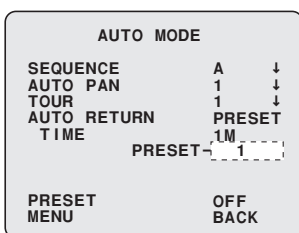

Available settings: 1 - 255

3 Use the joystick lever (↑↓) to select [TIME] and use the lever (←→) to select the duration until the AUTO RETURN function is activated.

Available settings: 10S, 20S, 30S, 40S, 50S, 1M, 2M, 3M, 4M, 5M, 6M, 7M, 8M, 9M, 10M
(S: Second, M: Minute)

After completing setting, use the lever to move the cursor to [MENU] and select "BACK" or "END".

Alarm Settings (ALARM)

This section describes the alarm input/output setting for the camera.

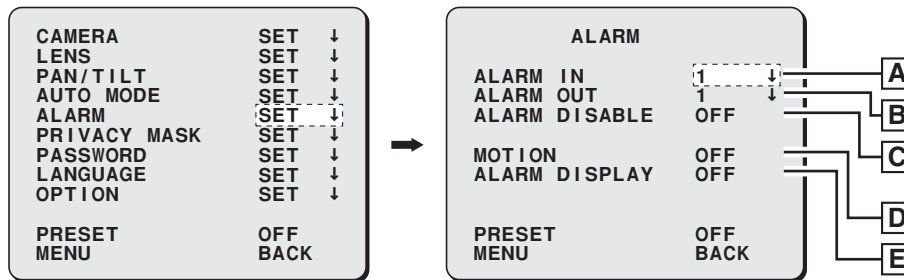

A Setting the alarm input (ALARM IN)

The ALARM IN screen allows you to perform the alarm settings (input preferences, alarm action, etc.) for each alarm input number.

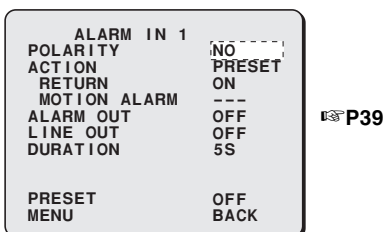

D Setting the motion sensor (MOTION)

Performs settings for the motion sensor used for detecting alarm.

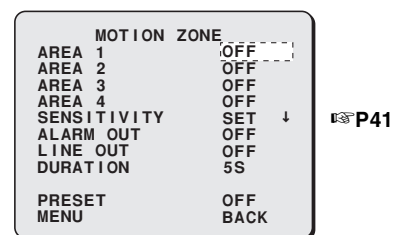

B Setting the alarm output (ALARM OUT)

The ALARM OUT screen allows you to perform the alarm output settings for each alarm output number.

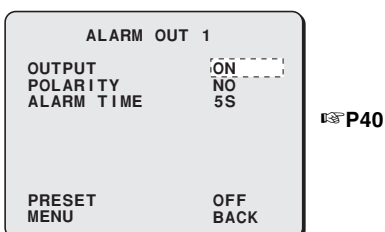

E Setting the alarm information display (ALARM DISPLAY)

When the alarm is detected, the preset number and the camera ID on the screen flash notifying that the alarm is detected.

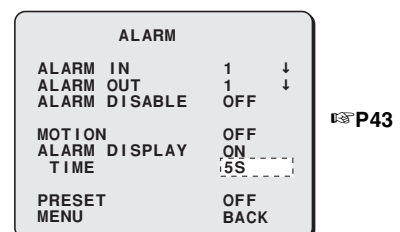

C Setting the alarm disabling duration (ALARM DISABLE)

The Alarm Disable function allows you to disable the alarm for the duration after the camera is operated manually.

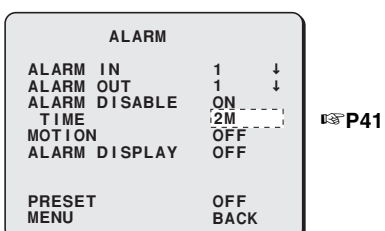

Alarm Settings (ALARM)

A Setting the alarm input (ALARM IN)

The ALARM IN screen allows you to perform the alarm settings (input preferences, alarm action, etc.) for each alarm input number.

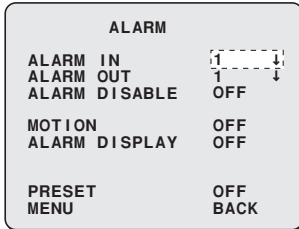

- 1 Use the joystick lever (↑↓) to select [ALARM IN], use the lever (←→) to select an alarm input number (1 - 8), and press the [ENTER] button.

The ALARM IN screen appears.

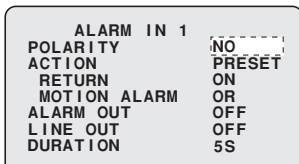

- 2 Use the joystick lever (↑↓) to select [POLARITY] and use the lever (←→) to select the polarity for the alarm input signal.

Available settings:

- **NO (Normal Open):**
Normally open so closed condition is detected as input.
- **NC (Normal Close):**
Normally closed so open condition is detected as input.

- 3 Use the joystick lever (↑↓) to select [ACTION] and use the lever (←→) to select the action after the alarm is detected (alarm action).

Available settings:

- **PRESET:** When the alarm is detected, the camera moves to the preset position whose preset number is the same as the alarm input number.



Before using the "PRESET" option, set the preset position for the corresponding alarm input number.

- **SEQ A - D:** Starts the Sequence mode operation (A - D).
- **PAN 1 - 4:** Starts the Auto Pan mode operation (1 - 4).
- **TOUR 1 - 4:** Starts the Tour mode operation (1 - 4).
- **OFF:** Does not perform the alarm action.

- 4 Use the joystick lever (↑↓) to select [RETURN] and use the lever (←→) to select the operation after the alarm action.

Available settings:

- **OFF:** Does not return to the operation status before the alarm.
- **ON:** Returns to the operation status before the alarm.

Memo:

- When [RETURN] is set to "ON", the camera returns to the before-alarm status after the duration specified in the [DURATION] setting.
- If another alarm input is received during the time specified in the [DURATION] setting, the operation will be performed according to the last alarm.

- 5 Use the joystick lever (↑↓) to select [MOTION ALARM] and use the lever (←→) to select how the motion sensor is used.

For alarm detection criteria, the motion sensor built into the camera can be used in combination with the alarm input from an external device.

Available settings:

- **AND:** When both the motion sensor and the external device detect an alarm condition, the alarm is activated.
- **OR:** When either the motion sensor or the external device detects an alarm condition, the alarm is activated.



Before enabling the settings under [MOTION], be sure to set [MOTION] in the ALARM screen to "PRESET".

- 6 Use the joystick lever (↑↓) to select [ALARM OUT] and use the lever (←→) to select an alarm output terminal.

The alarm signal can be output from the alarm output terminal, enabling you to connect external devices such as recorder, alarm buzzer and warning lamp.

Available settings:

- **OFF:** Does not output the alarm signal.
- **1:** Uses the output terminal 1.
- **2:** Uses the output terminal 2.

- 7 Use the joystick lever (↑↓) to select [LINE OUT] and use the lever (←→) to determine whether the alarm signal is output to the connection line to the system controller.

Available settings:

- **OFF:** Does not output the alarm signal to the connection line.
- **ON:** Outputs the alarm signal to the connection line.

Alarm Settings (ALARM)

8 Use the joystick lever (↑↓) to select [DURATION] and use the lever (←→) to select the interval after which the next alarm becomes in effect.

When an alarm is detected, another alarm signal will not be output until the duration specified in this setting has passed.

Available settings: 5S, 10S, 15S, 20S, 30S, 45S, 1M, 2M, 3M, 4M, 5M (S: Second, M: Minute)

Memo: The interval setting for the next alarm to become in effect is applied to the external switch whose number is the same as the alarm input number. The alarm input from other external switches will be accepted.



- When the alarm input is used as the external control input of the Day/Night function, "D/N" appears in the top right of the screen. In this case, settings other than [POLARITY] cannot be made.
- When multiple alarm inputs are received simultaneously, the input whose alarm number is smaller precedes the others.

☞ After completing setting, use the lever to move the cursor to [MENU] and select "BACK" or "END".

B Setting the alarm output (ALARM OUT)

The ALARM OUT screen allows you to perform the alarm output settings for each alarm output number.

| ALARM | |
|----------------------|----------|
| ALARM IN | 1 |
| ALARM OUT | 1 |
| ALARM DISABLE | OFF |
| MOTION ALARM DISPLAY | OFF |
| PRESET MENU | OFF BACK |

1 Use the joystick lever (↑↓) to select [ALARM OUT], use the lever (←→) to select an alarm output number (1- 2), and press the [ENTER] button.

The ALARM OUT screen appears.

| ALARM OUT 1 | |
|-------------|----------|
| OUTPUT | ON |
| POLARITY | NO |
| ALARM TIME | 5S |
| PRESET MENU | OFF BACK |

2 Use the joystick lever (↑↓) to select [OUTPUT] and use the lever (←→) to select an alarm output option.

Available settings:

- **OFF:** Does not output the alarm signal.
- **ON:** Outputs the alarm signal.
- **REMOTE:** Outputs the alarm signal by remote operation. (This option is available only when [ALARM OUT] is set to "2".)



- When selecting "REMOTE", "MANU" is available for [ALARM TIME] enabling the manual operation of the alarm output.
- When selecting "REMOTE", the alarm signal will not be output automatically even when the alarm is detected.

3 Use the joystick lever (↑↓) to select [POLARITY] and use the lever (←→) to select the polarity for the alarm output signal.

Available settings:

- **NO (Normal Open):** Normally open so closed condition is detected as output.
- **NC (Normal Close):** Normally closed so open condition is detected as output.

4 Use the joystick lever (↑↓) to select [ALARM TIME] and use the lever (←→) to select a duration for which the alarm signal is output.

The connected devices such as recorder, alarm buzzer and warning lamp will operate for the duration you have specified.

Available settings: 2S, 5S, 10S, 15S, 20S, 30S, 45S, 1M, 2M, 3M, 4M, 5M, MANU (S: Second, M: Minute)

Memo: "MANU" appears only when "REMOTE" is selected for [OUTPUT] in step 2.

☞ After completing setting, use the lever to move the cursor to [MENU] and select "BACK" or "END".

The alarm output duration for remote operation

The alarm output duration when using remote operation depends on the setting for [ALARM TIME].

- **When selecting the value between "2S" and "5M":** Outputs the alarm for the duration you have specified.
- **When selecting "MANU":** You can turn on or off the alarm output using the system controller. Press the [AUX ON] or [AUX OFF] button, and select "6" in the number entry screen.



While the alarm is output using remote operation, normal alarm output cannot be used.

Alarm Settings (ALARM)

C Setting the alarm disabling duration (ALARM DISABLE)

The Alarm Disable function allows the alarm input to be ignored for the specified duration during manual pan/tilt/zoom operations and after manual operation.

| ALARM | |
|---------------|----------|
| ALARM IN | 1 ↓ |
| ALARM OUT | 1 ↓ |
| ALARM DISABLE | ON |
| TIME | 2M |
| MOTION | OFF |
| ALARM DISPLAY | OFF |
| PRESET MENU | OFF BACK |

Memo: You can also turn on or off the ALARM DISABLE function by using the system controller. Press the [AUX ON] or [AUX OFF] button, and select "8" in the number entry screen.

1 Use the joystick lever (↑↓) to select [ALARM DISABLE], use the lever (←→) to select "ON/OFF", and press the [ENTER] button.

Available settings:

- **OFF:** Disables the Alarm Disable function.
- **ON:** Enables the Alarm Disable function. ([TIME] appears under [ALARM DISABLE].)

2 When "ON" is selected, use the joystick lever (↑↓) to select [TIME] and use the lever (←→) to select a duration for which the alarm input is ignored.

Available settings: 1M, 2M, 3M, 4M, 5M, 6M, 7M, 8M, 9M, 10M (M: Minute)

After completing setting, use the lever to move the cursor to [MENU] and select "BACK" or "END".

D Setting the motion sensor (MOTION)

The built-in motion sensor can be used to detect movements in the target object such as an intruder.

| ALARM | |
|---------------|----------|
| ALARM IN | 1 ↓ |
| ALARM OUT | 1 ↓ |
| ALARM DISABLE | OFF |
| MOTION | OFF |
| ALARM DISPLAY | OFF |
| PRESET MENU | OFF BACK |

Use the joystick lever (↑↓) to select [MOTION] and use the lever (←→) to select the motion sensor used for alarm detection.

Available settings:

- **OFF:** Does not use the motion sensor.
- **ZONE:** Uses the sensor specified for the motion zone. (The MOTION ZONE screen appears.)
- **PRESET:** Uses the motion sensor selected in [MOTION] of the [CAMERA VIEW] settings.

Memo: For the "PRESET" option, the movement is detected only at the preset position: for the [ZONE] option, the movement is detected for the area specified from whole space where pan/tilt operations can be performed.

Setting the motion zone

The Motion Zone function allows you to specify up to four surveillance areas (AREA 1 - 4) to detect movement.

Setting the surveillance area (AREA) and the detection option

To set the surveillance area and the detection option, perform the following procedure in the MOTION ZONE screen.

1 Use the joystick lever (↑↓) to select [MOTION], use the lever (←→) to select "ZONE", and press the [ENTER] button.

The MOTION ZONE screen appears.

| MOTION ZONE | |
|-------------|-------|
| AREA 1 | OFF |
| AREA 2 | OFF |
| AREA 3 | OFF |
| AREA 4 | OFF |
| SENSITIVITY | SET ↓ |
| ALARM OUT | OFF |
| LINE OUT | OFF |
| DURATION | 5S |

2 Use the joystick lever (↑↓) to select [AREA (1 - 4)], use the lever (←→) to select "ON ↓", and press the [ENTER] button.

The AREA setting menu appears.

| AREA 1 | |
|----------|-------|
| POSITION | SET ↓ |
| DISPLAY | OFF |

Alarm Settings (ALARM)

- 3** Use the joystick lever (↑↓) to select [POSITION] – “SET ↓”, and press the [ENTER] button.

The AREA screen for setting surveillance area appears. In this screen, while panning or tilting the camera, set the surveillance area to detect movement.

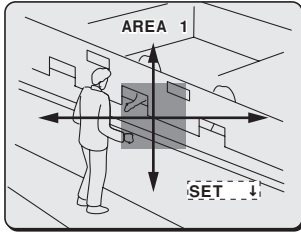

- 4** Use the joystick lever to perform panning or tilting, and press the [ENTER] button.

The POSITION screen appears displaying the detection pattern (in smallest size) in the center of the screen. In this screen, determine the position of the detection pattern.

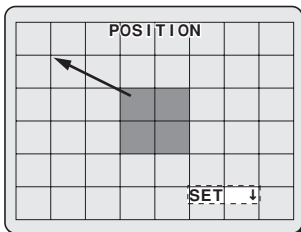

- 5** Use the joystick lever to move the detection pattern to your desired position, and press the [ENTER] button.

Move the detection pattern so that the pattern is located at the top left corner of the surveillance area.

Pressing the [ENTER] button displays the SIZE screen. In this screen, determine the size of the detection pattern.

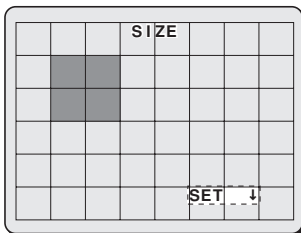

- 6** Use the joystick lever to adjust the size of the detection pattern, and press the [ENTER] button.

Originating from the position of the detection pattern specified in the POSITION screen, the joystick lever (↓) expands the pattern downward and the lever (→) expands the pattern to the right.

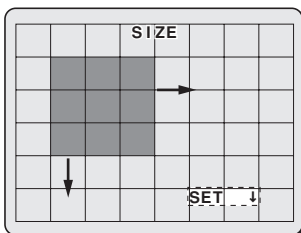

After pressing the [ENTER] button, the AREA setting menu appears again.

- 7** Use the joystick lever (↑↓) to select [DISPLAY] and use the lever (←→) to select “ON/OFF”.

Select whether the surveillance area specified in the AREA screen is displayed on the monitor screen or not.

Available settings:

- **OFF:** Does not display the surveillance area.
- **ON:** Displays the surveillance area.

- 8** To continue setting other surveillance area (2 - 4): After returning to the MOTION ZONE screen, repeat the same procedure (Steps 2 to 7).

Setting the detection sensitivity

You can set the level of sensitivity for motion detection. Adjusting the level of sensitivity avoids unwanted detection.

To set the detection sensitivity, perform the following procedure in the MOTION ZONE screen.

- 1** Use the joystick lever (↑↓) to select [SENSITIVITY] – “SET ↓”, and press the [ENTER] button.

The SENSITIVITY screen appears.

Set the detection level for the following parameters.

For all parameters, the larger the value, the lower the sensitivity.

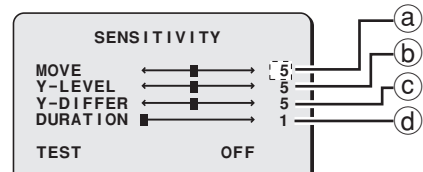

- a Motion sensitivity (MOVE): 1 - 10**
To avoid detection of small movements, make the value larger.
- b Brightness level (Y-LEVEL): 1 - 10**
When noise from a dark screen is causing erroneous detections, make the value larger.
- c Brightness differences (Y-DIFFER): 1 - 10**
To avoid detection of lights turning on and off, make the value larger.
- d Duration (DURATION): 1 - 60**
To avoid detection of fast movements, make the value larger.

- 2** To test the sensitivity settings, use the joystick lever (↑↓) to select [TEST] and use the lever (←→) to select a surveillance area number (1 - 4).

You can test the detection sensitivity for the specified surveillance area.

When a motion is detected, patterns are shown in that location. Adjust the setting values as necessary.

Alarm Settings (ALARM)

Setting the alarm signal output

Set the alarm output options for the alarm detection in the surveillance area (AREA 1 - 4).

After returning to the MOTION ZONE screen, perform the following procedure.

| MOTION ZONE | |
|-------------|-------|
| AREA 1 | OFF |
| AREA 2 | OFF |
| AREA 3 | OFF |
| AREA 4 | OFF |
| SENSITIVITY | SET ↓ |
| ALARM OUT | OFF |
| LINE OUT | OFF |
| DURATION | 5S |
| PRESET | OFF |
| MENU | BACK |

- 1 Use the joystick lever (↑↓) to select [ALARM OUT] and use the lever (←→) to select an alarm output terminal.

Available settings:

- **OFF:** Does not output the alarm signal.
- **1:** Uses the output terminal 1.
- **2:** Uses the output terminal 2.

- 2 Use the joystick lever (↑↓) to select [LINE OUT] and use the lever (←→) to determine whether the alarm signal is output to the connection line with the system controller.

Available settings:

- **OFF:** Does not output the alarm signal to the connection line.
- **ON:** Outputs the alarm signal to the connection line.

- 3 Use the joystick lever (↑↓) to select [DURATION] and use the lever (←→) to select the interval after which the next alarm becomes in effect.

Available settings: 5S, 10S, 15S, 20S, 30S, 45S, 1M, 2M, 3M, 4M, 5M (S: Second, M: Minute)

☞ After completing setting, use the lever to move the cursor to [MENU] and select "BACK" or "END".

E Setting the alarm information display (ALARM DISPLAY)

When the alarm is detected, the preset number and the camera ID on the screen flash notifying that the alarm is detected.

Monitor display legend

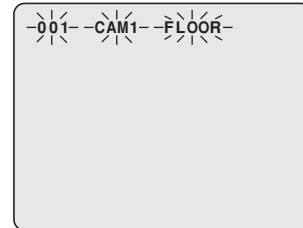

| ALARM | |
|---------------|--------|
| ALARM IN | 1 ↓ |
| ALARM OUT | 1 ↓ |
| ALARM DISABLE | ON |
| TIME | 1M |
| MOTION | PRESET |
| ALARM DISPLAY | ON |
| TIME | 5S |
| PRESET | OFF |
| MENU | BACK |

- 1 Use the joystick lever (↑↓) to select [ALARM DISPLAY] and use the lever (←→) to select "ON/OFF".

Available settings:

- **OFF:** The alarm information does not flash.
- **ON:** The alarm information flashes.
([TIME] appears under [ALARM DISPLAY].)

- 2 When "ON" is selected, use the joystick lever (↑↓) to select [TIME], and use the lever (←→) to select the duration for which the alarm information is flashing.

Available settings: 5S, 10S, 15S, 20S, 30S, 45S, 1M, 2M, 3M, 4M, 5M (S: Second, M: Minute)

☞ After completing setting, use the lever to move the cursor to [MENU] and select "BACK" or "END".

Privacy Mask Settings (PRIVACY MASK)

Depending on the target object, a certain part of the surveillance image may need to be protected for privacy. You can use the privacy mask (gray) to cover such part for privacy. Up to 24 privacy masks can be set.

| | | |
|--------------|-----|---|
| CAMERA | SET | ↓ |
| LENS | SET | ↓ |
| PAN/TILT | SET | ↓ |
| AUTO MODE | SET | ↓ |
| ALARM | SET | ↓ |
| PRIVACY MASK | SET | ↓ |
| PASSWORD | SET | ↓ |
| LANGUAGE | SET | ↓ |
| OPTION | SET | ↓ |

- 1 Use the joystick lever (↑↓) to select [PRIVACY MASK] – “SET ↓”, and press the [ENTER] button.

The MASK NO.SELECT screen appears.

| | |
|-----------------|------|
| MASK NO. SELECT | |
| MASK 1 | OFF |
| MASK 2 | OFF |
| MASK 3 | OFF |
| MASK 4 | OFF |
| MASK 5 | OFF |
| MASK 6 | OFF |
| MASK 7 | OFF |
| MASK 8 | OFF |
| PRESET | OFF |
| MENU | BACK |

- 2 Use the joystick lever (↑↓) to select a privacy mask number (1 - 24), use the lever (←→) to select “SET ↓”, and press the [ENTER] button.

The POSITION screen appears and the mask pattern is displayed at the center of the screen.



- 3 Use the joystick lever to move the surveillance image to determine the masking position, and press the [ENTER] button.

The SIZE screen appears.



Memo: While the lens reaches the tilt end (TILT LIMIT to "OFF"), pressing the [ENTER] button fixes the surveillance image. Use the joystick lever to move the mask pattern to determine the masking position, and press the [ENTER] button.

- 4 Use the joystick lever (↑↓) to adjust the vertical size and use the lever (←→) to adjust the horizontal size, and press the [ENTER] button.

The TEST screen appears. You can confirm how the mask pattern is set by using the joystick lever to move the surveillance location.



- 5 Press the [ENTER] button.

This completes the privacy mask setting and the MASK NO.SELECT screen appears again. Make sure that the [MASK] setting is set to “ON”.

To continue setting other privacy masks, repeat steps 2 to 4.

After completing setting, use the lever to move the cursor to [MENU] and select “BACK” or “END”.

Turning on or off the privacy mask

After the privacy mask is set, the mask can be turned on or off as necessary.

Use the joystick lever (↑↓) to select the mask number and use the lever (←→) to select “ON/OFF”.

| | |
|-----------------|-----|
| MASK NO. SELECT | |
| MASK 1 | OFF |
| MASK 2 | OFF |
| MASK 3 | OFF |
| MASK 4 | OFF |

Turning the MASK NO.SELECT screen page

Up to 24 privacy masks can be set and the MASK NO.SELECT screen is divided into three pages. To turn the page, use the joystick lever to move the cursor to the page switching buttons, use the lever (←→) to select the advance or reverse button, and press the [ENTER] button.

◀◀◀: To the previous page

▶▶▶: To the next page

| | | | |
|--------|------|---------|------------------------|
| MASK 7 | OFF | ◀◀◀ ▶▶▶ | Page switching buttons |
| MASK 8 | OFF | | |
| PRESET | OFF | | |
| MENU | BACK | | |

The maximum number of privacy masks

You can set up to 24 privacy masks in total, and up to 4 privacy masks can be set per screen.

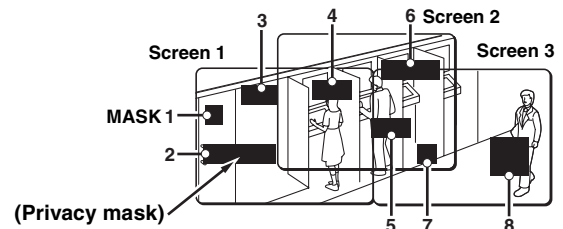

! If you set more than four privacy masks per screen, “** > 4 !” appears to the right of the screen title and the privacy mask with the largest setting number will be deleted.

Password Settings (PASSWORD)

Password can be used to limit the menu setting operations to specific users.

| | | |
|--------------|------|---|
| CAMERA | SET | ↓ |
| LENS | SET | ↓ |
| PAN/TILT | SET | ↓ |
| AUTO MODE | SET | ↓ |
| ALARM | SET | ↓ |
| PRIVACY MASK | SET | ↓ |
| PASSWORD | SET | ↓ |
| LANGUAGE | SET | ↓ |
| OPTION | SET | ↓ |
| PRESET | OFF | |
| MENU | BACK | |

Enabling password lock

When the password lock is enabled, users are prompted to enter password to display the menu screens. Set the password by displaying the PASSWORD screen under the respective menus.

Memo: Different passwords can be specified for the main menu and the advanced menu respectively.

- 1 Use the joystick lever (↑↓) to select [PASSWORD] – “SET ↓”, and press the [ENTER] button.

The PASSWORD screen appears.

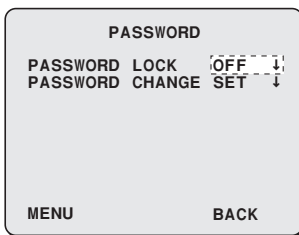

- 2 Use the joystick lever (↑↓) to select [PASSWORD LOCK] – “OFF ↓”, and press the [ENTER] button.

The screen for entering the password appears.

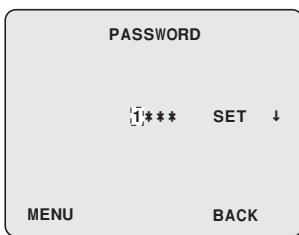

- 3 Use the joystick lever (←→) to select the digit and use the lever (↑↓) to select a number.

When setting the password first time, use the factory setting value (1234).

- 4 After entering your four-digit password, press [ENTER].

When the valid password is entered, “OK” appears under the password entry field and the password lock is enabled.

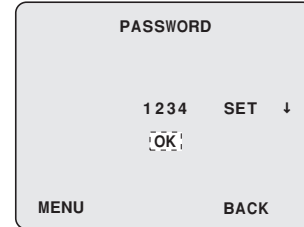

If an invalid password is entered, “NG” appears and the cursor moves to “BACK”.

- After completing setting, use the lever to move the cursor to [MENU] and select “BACK” or “END”.

Disabling password lock

- 1 Use the joystick lever (↑↓) to select [PASSWORD] – “SET ↓”, and press the [ENTER] button.

The PASSWORD screen appears.

- 2 Use the joystick lever (↑↓) to select [PASSWORD LOCK] – “ON ↓”, and press the [ENTER] button.

The screen for entering the password appears.

- 3 Use the joystick lever to enter the password into the entry field, and press [ENTER].

“OK” appears under the entry field and the password lock is disabled.

- After completing setting, use the lever to move the cursor to [MENU] and select “BACK” or “END”.

Password Settings (PASSWORD)

■ Changing the password

- 1** Use the joystick lever (↑↓) to select [PASSWORD] – “SET ↓”, and press the [ENTER] button.

The PASSWORD screen appears.

- 2** Use the joystick lever (↑↓) to select [PASSWORD CHANGE] – “SET ↓”, and press the [ENTER] button.

The screen for changing the password appears.

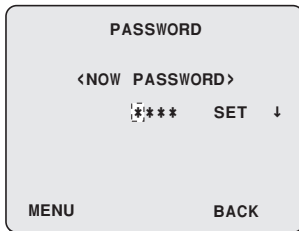

- 3** Use the joystick lever to enter current password into the NOW PASSWORD field, and press [ENTER].

If the password currently used is authenticated, the NEW PASSWORD field appears.

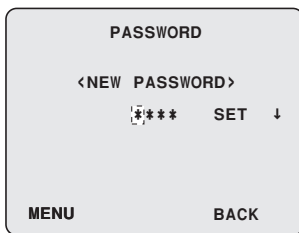

- 4** Use the joystick lever to enter new password into the NEW PASSWORD field, and press [ENTER].

“OK” appears under the NEW PASSWORD field and the new password is set.

☞ After completing setting, use the lever to move the cursor to [MENU] and select “BACK” or “END”.

Language Settings (LANGUAGE)

Performs language settings for display. The initial setting is English.

| | | |
|--------------|------|---|
| CAMERA | SET | ↓ |
| LENS | SET | ↓ |
| PAN/TILT | SET | ↓ |
| AUTO MODE | SET | ↓ |
| ALARM | SET | ↓ |
| PRIVACY MASK | SET | ↓ |
| PASSWORD | SET | ↓ |
| LANGUAGE | SET | ↓ |
| OPTION | SET | ↓ |
| PRESET | OFF | |
| MENU | BACK | |

- 1 Use the joystick lever (↑↓) to select [LANGUAGE] – “SET ↓”, and press the [ENTER] button.

The LANGUAGE screen appears.

| | |
|----------|---------|
| LANGUAGE | |
| LANGUAGE | ENGLISH |
| LANGUE | FRENCH |
| SPRACHE | GERMAN |
| MENU | BACK |

- 2 Use the joystick lever (↑↓) to select the language used for display and press the [ENTER] button.

The display changes to the selected language.

English

| | |
|----------|---------|
| LANGUAGE | |
| LANGUAGE | ENGLISH |
| LANGUE | FRENCH |
| SPRACHE | GERMAN |
| MENU | BACK |

French

| | |
|----------|----------|
| LANGUE | |
| LANGUAGE | ANGLAIS |
| LANGUE | FRANCAIS |
| SPRACHE | ALLEMAND |
| MENU | RETOUR |

German

| | |
|----------|---------|
| SPRACHE | |
| LANGUAGE | ENGLISH |
| LANGUE | FRANZ |
| SPRACHE | DEUTSCH |
| MENUE | ZURUECK |

After completing setting, use the lever to move the cursor to [MENU] and select “BACK” or “END”.

Miscellaneous Settings (OPTION)

The OPTION menu is used to perform miscellaneous settings for the camera.

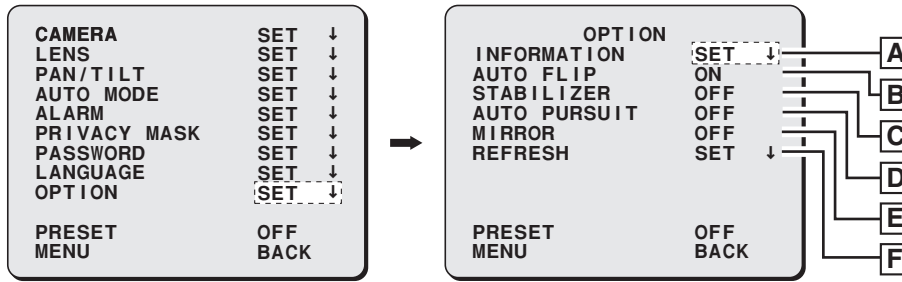

A Setting the display information (INFORMATION)

Sets the type and position of the information displayed on the monitor.

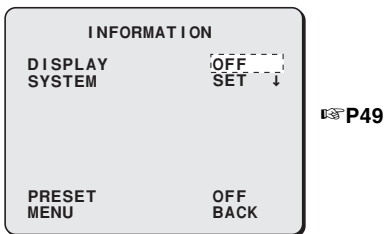

D Setting the auto pursuit function (AUTO PURSUIT)

When this function is enabled, the orientation of the camera automatically changes pursuing the target object.

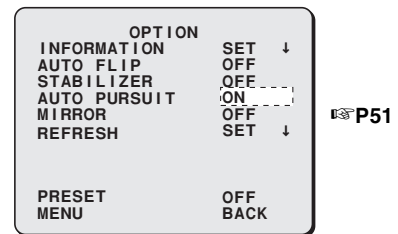

B Setting the auto flip function (AUTO FLIP)

Rotates the displayed image up or down, left or right electronically when the camera tilts beyond the straight down position.

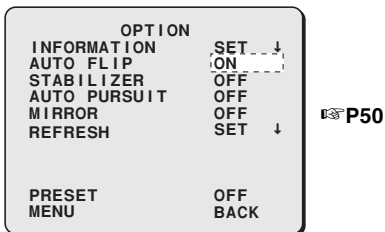

E Setting the mirroring function (MIRROR)

Reverses the displayed image electronically.

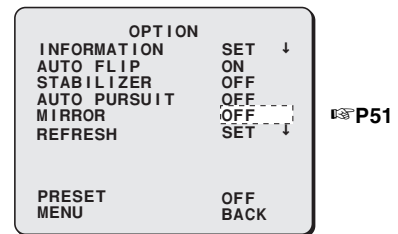

C Correcting the sway of the camera (STABILIZER)

When the sway of the camera occurs, the image from the camera is corrected automatically.

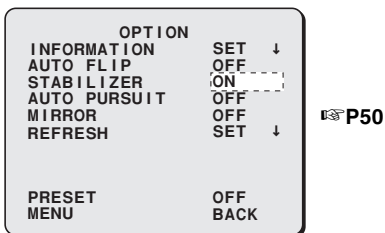

F Performing the refresh function (REFRESH)

Cleans the camera's horizontal rotation contact area.

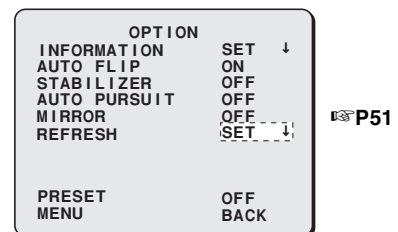

Miscellaneous Settings (OPTION)

A Setting the display information (INFORMATION)

Sets the type and position of the information displayed on the monitor.

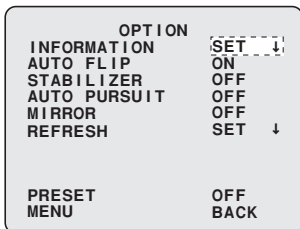

■ Setting the item to be displayed (DISPLAY)

- 1 Use the joystick lever (↑↓) to select [INFORMATION] – “SET ↓”, and press the [ENTER] button.

The INFORMATION screen appears.

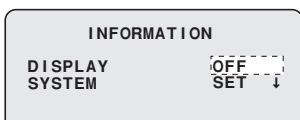

- 2 Use the joystick lever (↑↓) to select [DISPLAY], use the lever (←→) to select “ON ↓”, and press the [ENTER] button.

The DISPLAY screen appears.

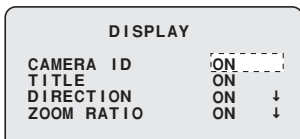

- 3 Use the joystick lever (↑↓) to select the information item, use the lever (←→) to select “ON (displayed)/OFF (not displayed)”, and press the [ENTER] button.

Available settings:

- CAMERA ID
- TITLE
- DIRECTION (Pan/tilt angle)
- ZOOM RATIO (Magnification power in zooming)

Adjusting the display position

For [DIRECTION] and [ZOOM RATIO], you can adjust the display position.

Selecting “ON ↓” for the item to adjust the display position and pressing the [ENTER] button displays the adjusting screen. Use the joystick lever to adjust the display position for the item.

To return to the DISPLAY screen, press the [ENTER] button again.

- ☞ After completing setting, use the lever to move the cursor to [MENU] and select “BACK” or “END”.

■ Displaying the system information (SYSTEM)

- 1 Use the joystick lever (↑↓) to select [INFORMATION] – “SET ↓”, and press the [ENTER] button.

The INFORMATION screen appears.

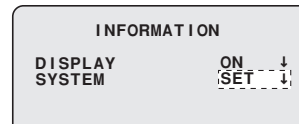

- 2 Use the joystick lever (↑↓) to select [SYSTEM] – “SET ↓”, and press the [ENTER] button.

The system information is displayed in the screen.

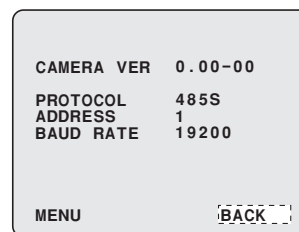

Setting the camera's address

If the address setting switch on the camera is set to “0”, you can use the menu screen to specify the camera's address.

- 1 In the system information screen, select [ADDRESS] and press the [ENTER] button.

If the address setting switch on the camera is set to “0”, the address number is highlighted.

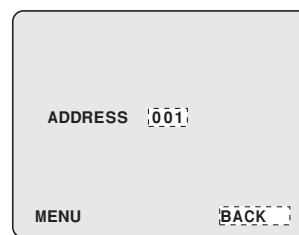

The initial setting for the address is “001”.

- 2 Use the joystick lever to enter the address number.

Use the lever (←→) to select a digit to enter a number and use the lever (↑↓) to select number.

- 3 Use the joystick lever (←) to highlight the address again.

This completes the address setting.

Memo: After turning off and on the camera again, the address setting becomes effective.

- ☞ After completing setting, use the lever to move the cursor to [MENU] and select “BACK” or “END”.

Miscellaneous Settings (OPTION)

B Setting the auto flip function (AUTO FLIP)

Rotates the displayed image up or down, left or right electronically when the camera tilts beyond the straight down position.

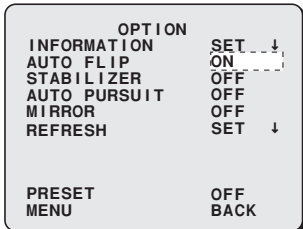

1 Use the joystick lever (↑↓) to select [AUTO FLIP] and use the lever (←→) to select "ON".

Available settings:

- **OFF:** Disables the Auto Flip function. (When the tilting angle reaches 90 degrees, the camera stops.)
- **ON:** Enables the Auto Flip function, allowing you to continue monitoring when the camera is tilted beyond the straight down position.

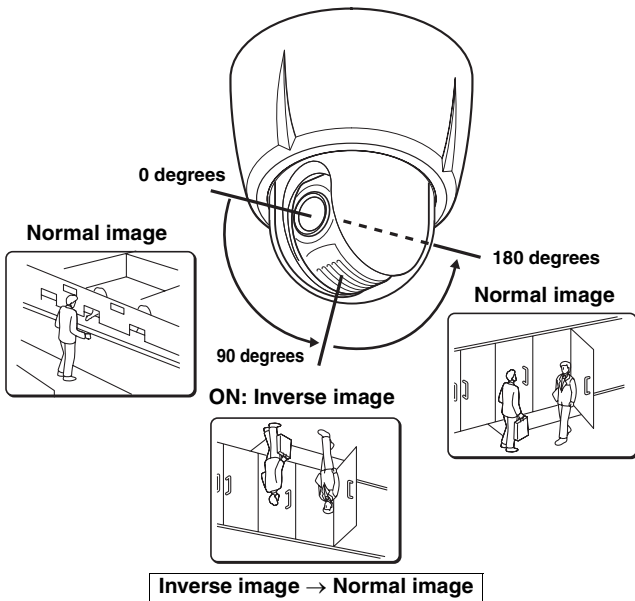

The image is rotated automatically to change inverse image to normal image.

! An image is rotated upside down electronically when the tilting angle reaches around 90 degrees. (When the Auto Flip takes place, the tilting motion momentarily stops.)

⌂ After completing setting, use the lever to move the cursor to [MENU] and select "BACK" or "END".

C Correcting the sway of the camera (STABILIZER)

When the base on which the camera is installed (e.g. column, pole or wall) sways, the image from the camera is corrected automatically.

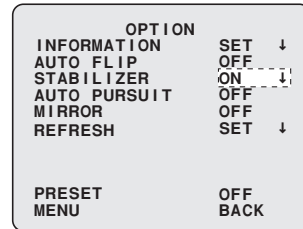

1 Use the joystick lever (↑↓) to select [STABILIZER] and use the lever (←→) to select "ON ↓", and press the [ENTER] button.

The STABILIZER screen appears.

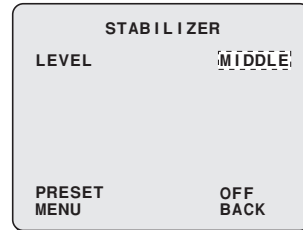

Set [STABILIZER] to "OFF" in the OPTION screen when the correction of the sway is not required.

2 Use the joystick lever (←→) to select the correction level.

The higher the collection level, the more the amount of correction, covering the large sway.

Available settings:

- **LOW:**
- **MIDDLE:**
- **HIGH:**



- The waver correction function may not work depending on the magnitude of waver and/or its frequency.
- The waver correction function does not work while the camera is in motion during such operation or mode as panning, tilting, zooming, automatic panning (AUTO MODE) or moving to a preset position (PRESET GO). However, the waver correction is available when the camera is in resting state, even if any of these functions or modes is selected.
- While the waver is being corrected, the resolution of the image degrades and the angle of the image narrows a bit. The higher the correction level, the lower the resolution, and the narrower the angle.

⌂ After completing setting, use the lever to move the cursor to [MENU] and select "BACK" or "END".

Miscellaneous Settings (OPTION)

D Setting the auto pursuit function (AUTO PURSUIT)

When the motion sensor detects a movement of the target object, the orientation of the camera automatically changes pursuing the target object.

| OPTION | |
|--------------|-------|
| INFORMATION | SET ↓ |
| AUTO FLIP | OFF |
| STABILIZER | OFF |
| AUTO PURSUIT | ON ↓ |
| MIRROR | OFF |
| REFRESH | SET ↓ |

! This function cannot be configured when [MOTION] in the ALARM screen is set to "PRESET" or "ZONE".

Memo: You can also turn on or off the AUTO PURSUIT function by using the system controller. Press the [AUX ON] or [AUX OFF] button, and select "9" in the number entry screen.

1 Use the joystick lever (↑↓) to select [AUTO PURSUIT] and use the lever (←→) to select "ON ↓", and press the [ENTER] button.

The AUTO PURSUIT screen appears.

| AUTO PURSUIT | |
|---------------|-----|
| [SENSITIVITY] | |
| ← | → 7 |
| TEST | OFF |

If you do not enable the auto pursuit function, set [AUTO PURSUIT] in the OPTION screen to "OFF".

2 Use the joystick lever (↑↓) to select [SENSITIVITY], and use the lever (←→) to set the sensitivity for movement detection.

The higher the setting value, the lower the sensitivity.

3 If you want to test the sensitivity, use the joystick lever (↑↓) to select [TEST], and use the lever (←→) to select [ON].

When a movement is detected, a sensor pattern appears at the detected position. Adjust the setting value as necessary.

- !** The motion sensor detects the movement of the target object by perceiving the change of the brightness. The pursuit function may not work depending on the condition including the size or brightness of the target object.
- When there are multiple target objects that are moving, the camera pursues the target object whose change of the brightness is larger.
- The auto pursuit function is not activated while panning, tilting or zooming function is in operation, or AUTO MODE or PRESET GO mode is selected.

ⓘ After completing setting, use the lever to move the cursor to [MENU] and select "BACK" or "END".

E Setting the mirroring function (MIRROR)

Reverses the displayed image electronically. This function can be used when the camera is installed upside down or when performing surveillance through a mirror.

| OPTION | |
|--------------|-------|
| INFORMATION | SET ↓ |
| AUTO FLIP | ON |
| STABILIZER | OFF |
| AUTO PURSUIT | OFF |
| MIRROR | OFF ↓ |
| REFRESH | SET ↓ |

1 Use the joystick lever (↑↓) to select [MIRROR] and use the lever (←→) to select a mirroring mode.

Available settings:

- OFF:** Normal image
- HV:** Rotated horizontally and vertically.
- H:** Rotated horizontally.
- V:** Rotated vertically.

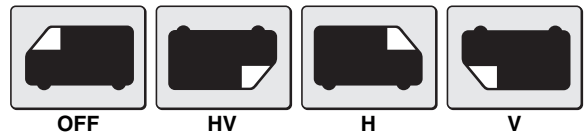

Memo: The "HV" option can be used when the camera is installed on the floor. In this option, the direction to which the joystick lever is moved matches the direction to which the camera pans and tilts.

ⓘ After completing setting, use the lever to move the cursor to [MENU] and select "BACK" or "END".

F Performing the refresh function (REFRESH)

Cleans the camera's horizontal rotation contact area.

| OPTION | |
|--------------|-------|
| INFORMATION | SET ↓ |
| AUTO FLIP | ON |
| STABILIZER | OFF |
| AUTO PURSUIT | OFF |
| MIRROR | OFF |
| REFRESH | SET ↓ |

1 Use the joystick lever (↑↓) to select [REFRESH] – "SET ↓", and press the [ENTER] button.

Cleaning starts, and after the cleaning completes the startup movements are performed.

Memo: The horizontal rotation contact area of the camera always moves. When the contact area becomes dirty, the camera's operation can be unstable, burst can occur, or preset positions may deviate. It is recommended to clean the rotation contact area periodically by using the Refresh function.

ⓘ After completing setting, use the lever to move the cursor to [MENU] and select "BACK" or "END".

Menu Structure Diagram

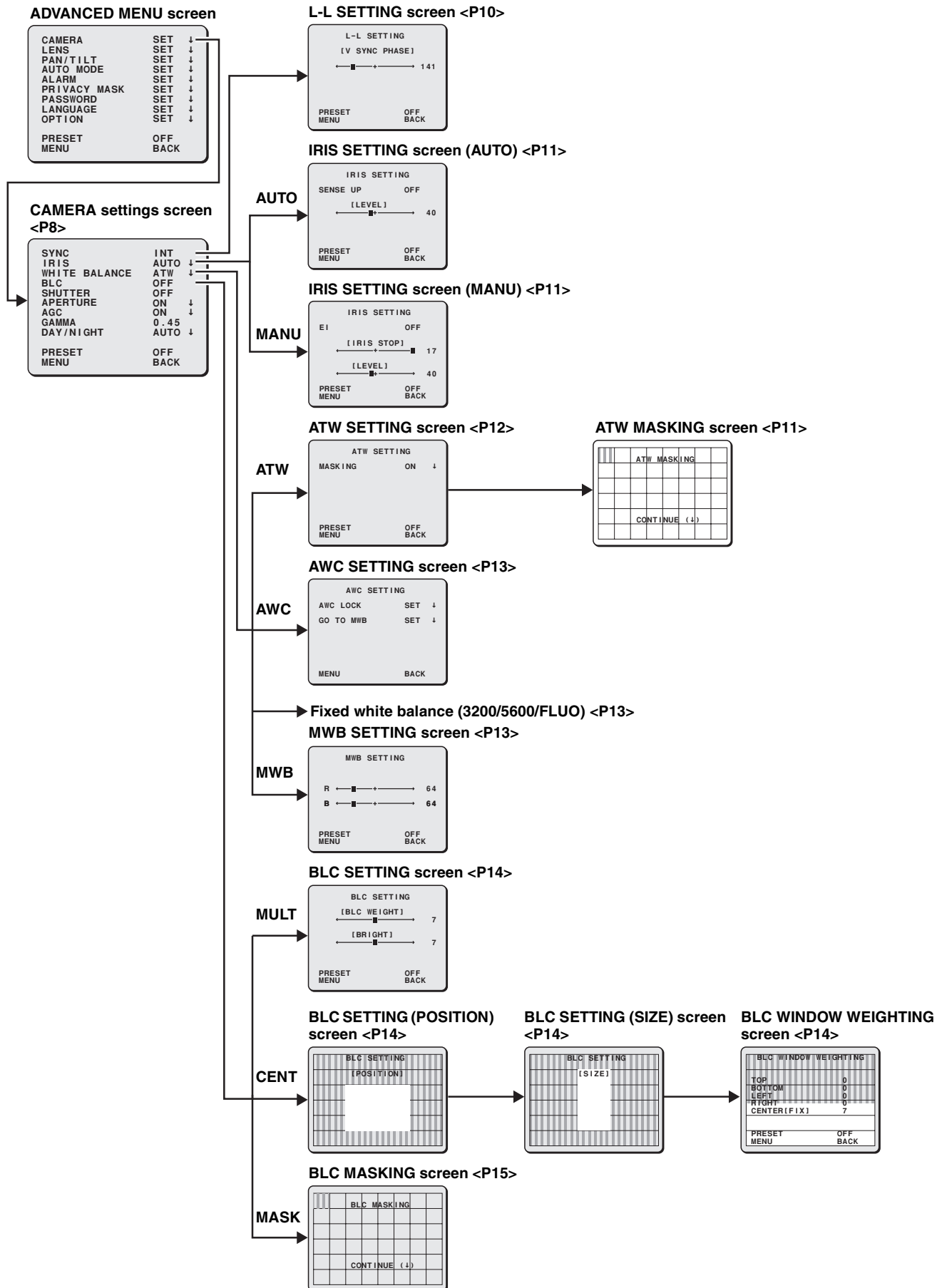

Menu Structure Diagram

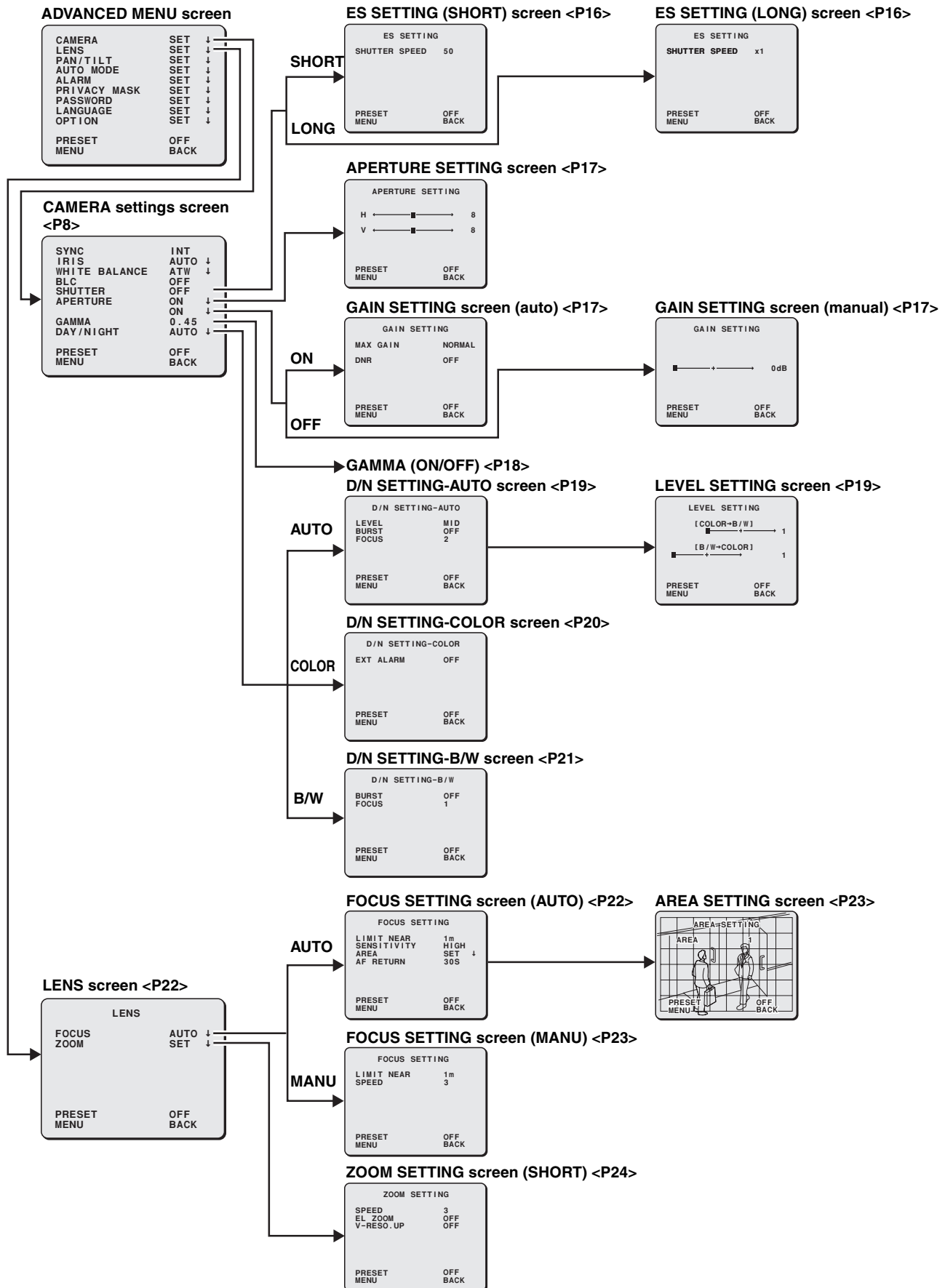

Menu Structure Diagram

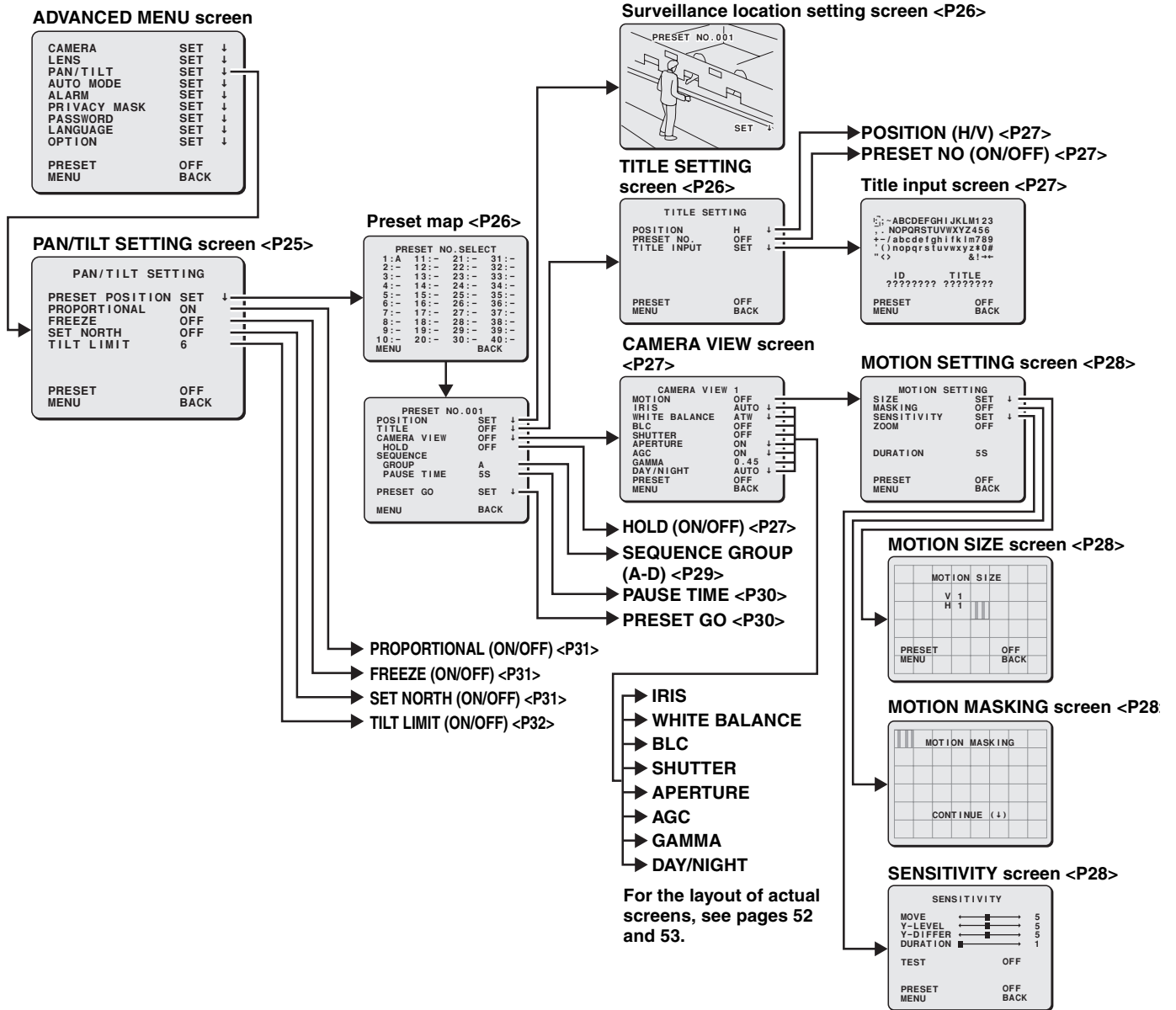

Menu Structure Diagram

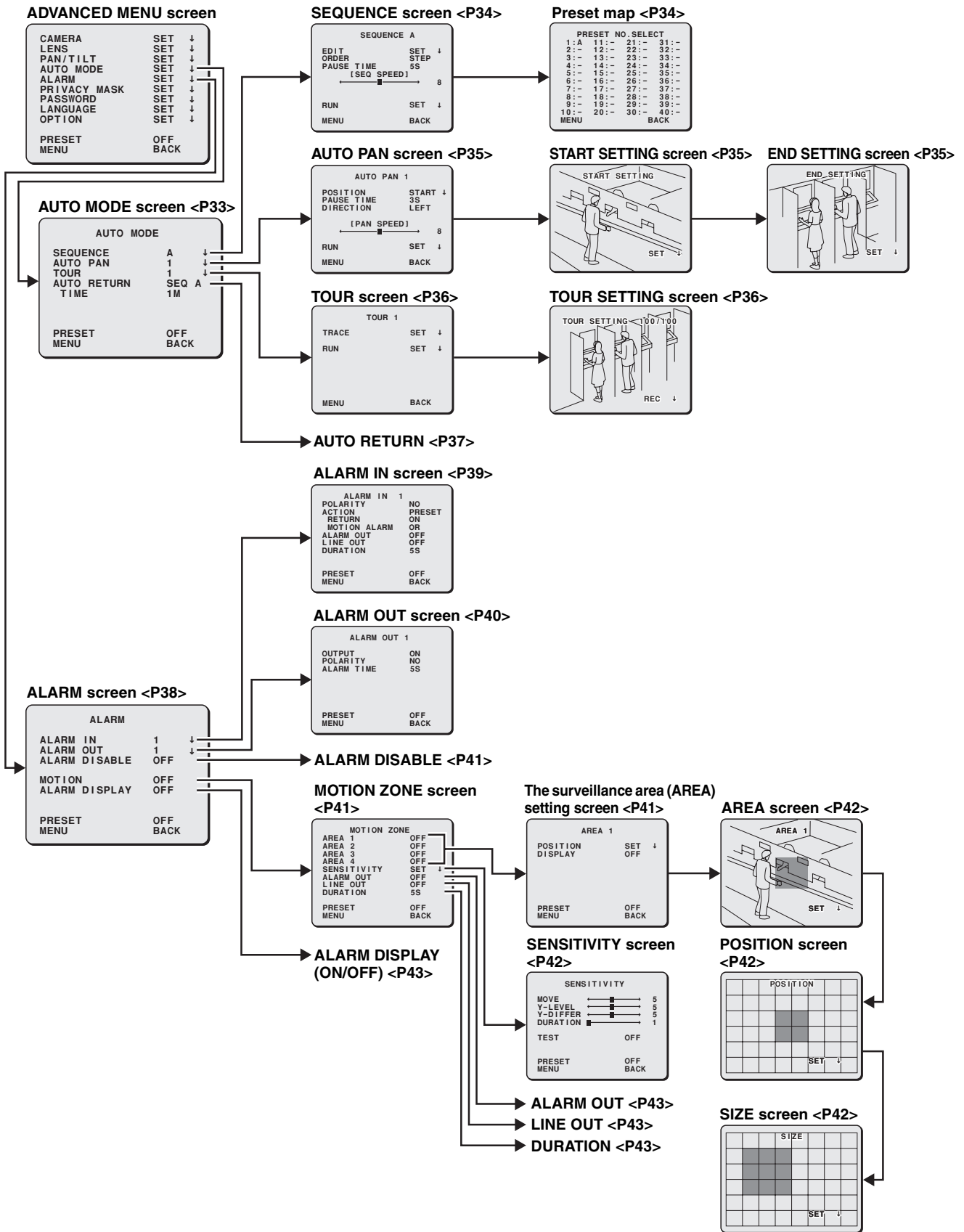

Menu Structure Diagram

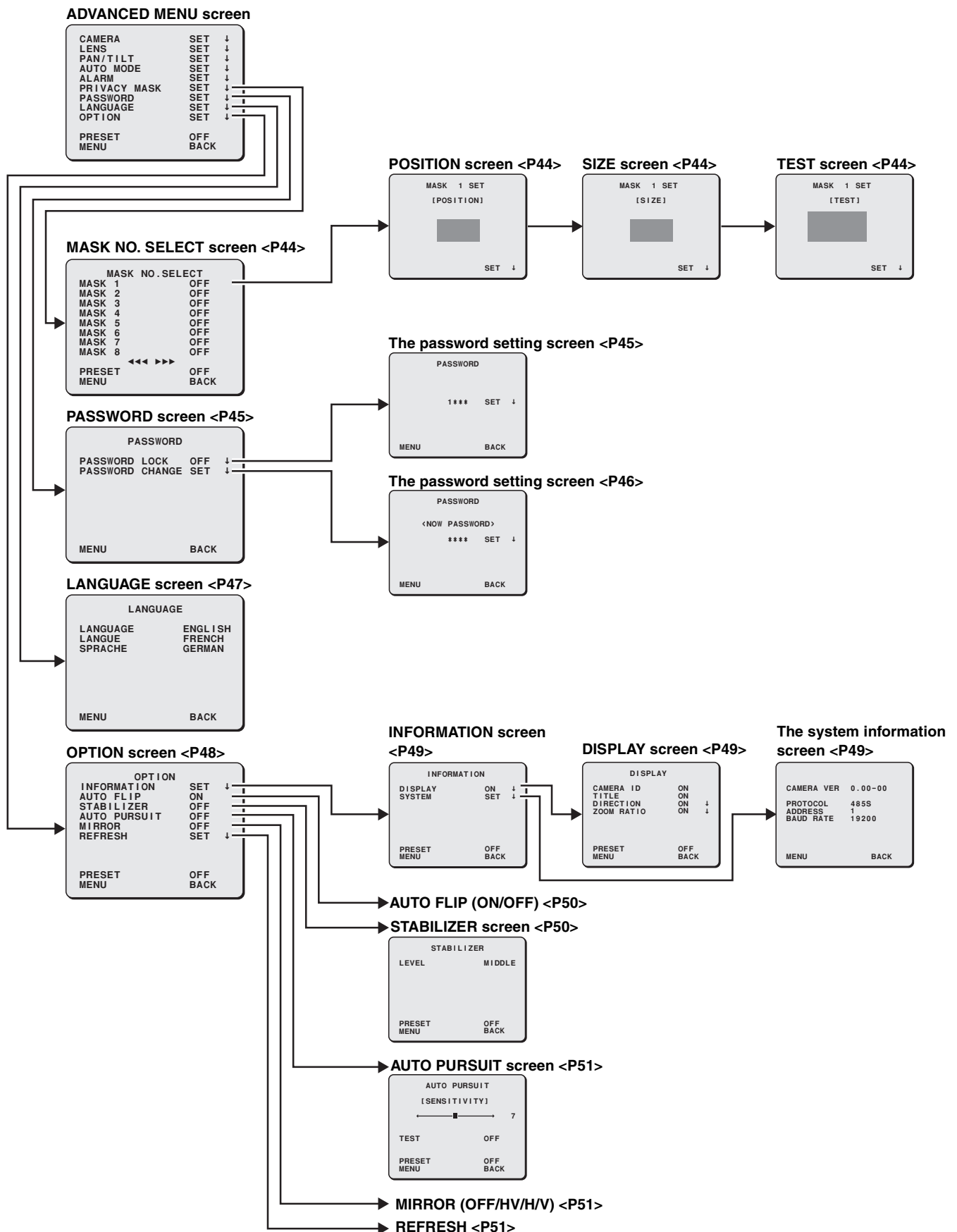

Specifications

| | |
|---|---|
| Image sensor | : 1/4" |
| Effective pixels | : 752 (H) x 582 (V) |
| Horizontal resolution | : Over 520 TV lines |
| Lens | : x36 zoom lens, f=3.4 - 122.4 mm (F1.6 - 4.5) Electronic zoom and gearing Zoom speed setting possible |
| Electronic zoom | : 16 power (combined with optic zoom gives 576 power max) Max zoom magnification setting possible Vertical resolution ON/OFF setting |
| Auto focus | : AUT/ONE-PUSH/MANUAL AF area setting possible (3 step) |
| Iris control | : AUTO/MANUAL |
| Synchronization method | : Internal synchronization/Line lock V phase adjustment possible |
| Lowest image illumination | : 1.0 lx (F1.6, AGC gain at maximum, COLOR mode) 0.05 lx (F1.6, AGC gain at maximum, B/W mode) 0.032 lx (F1.6, AGC gain at maximum, x32 SENSE UP, COLOR mode) 0.002 lx (F1.6, AGC gain at maximum, x32 SENSE UP, B/W mode) |
| S/N | : Over 50 dB |
| Backlight compensation | : Center-weighted average metering/multi-spot evaluative metering |
| Day/Night (For VCC-800P only) | : AUTO / COLOR / B/W settings available |
| Electronic shutter | : • Fast shutter speed (SHORT) mode: 1/50, 1/120, 1/250, 1/500, 1/1000, 1/2000, 1/4000, 1/10000 • Slow shutter speed (LONG) mode: x1, x2, x4, x8, x16, x32 |
| Electronic sensitivity boosting | : AUTO/OFF, works with auto iris Up to x32 max setting possible |
| White balance | : ATW/AWC/MWB/3200/5600/FLUO (Fluorescent lighting) |
| AGC gain | : Low/Normal/Middle/High/Off (When "OFF" is selected, manual gain adjustment is available.) |
| Motion sensor | : ON/OFF, individual settings possible |
| Aperture | : H/V setting possible |
| Privacy masking | : ON/OFF, max of 24 masked locations (Wide view screen; 1 screen max 4 masks) The mask can be set regardless of the camera's direction. |
| Alarm input/output | : External input: 8, External output: 2, NO (Normal open)/NC (Normal closed) switch Motion sensor with external alarm AND/OR output options |
| Camera titles | : ON/OFF, 16 characters |
| Camera view | : 8 settings |
| Auto mode | : Sequential pan/auto pan/tour (4 patterns each), Auto return |
| Rotation range | : Horizontal: 360° endless. Vertical: -5° - 185° |
| Rotation speed | : Horizontal- Preset: 435°/second. Manual: 0.1° - 120°/second Vertical- Preset: 400°/second. Manual: 0.1° - 120°/second |
| Preset positions | : 256 positions |
| Communications | : Coaxial control, RS-485 |
| Operational temperature/humidity | : -10 - 50°C/below 90% RH |
| Power source | : DC 24 V |

External appearance and specifications subject to change without notice.



Free Manuals Download Website

<http://myh66.com>

<http://usermanuals.us>

<http://www.somanuals.com>

<http://www.4manuals.cc>

<http://www.manual-lib.com>

<http://www.404manual.com>

<http://www.luxmanual.com>

<http://aubethermostatmanual.com>

Golf course search by state

<http://golfingnear.com>

Email search by domain

<http://emailbydomain.com>

Auto manuals search

<http://auto.somanuals.com>

TV manuals search

<http://tv.somanuals.com>