

## INSTRUCTION MANUAL

## SRT-2400

---

**Real Time Video Recorder**

English

---

**Magnétoscope à en temps réel**

Français

---

**Videograbador en tiempo real**

Español

---

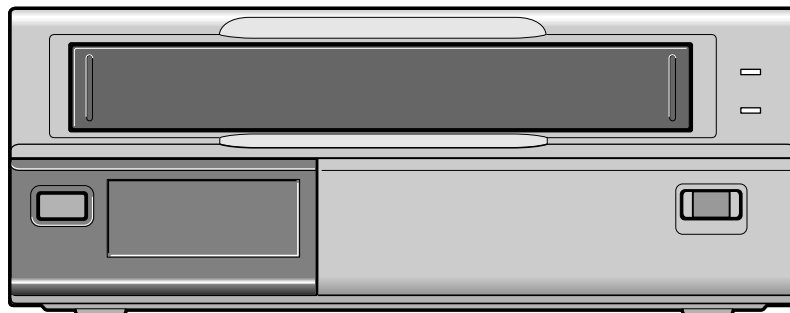

Please read this manual and accompanying "IMPORTANT SAFETY INSTRUCTIONS" sheet carefully before connecting your VCR and operating it for the first time.

Be sure to read carefully and follow all the PRECAUTIONS on page 1 and 2.

Keep the manual in a safe place for future reference.

# PRECAUTIONS



## CAUTION

RISK OF ELECTRIC SHOCK  
DO NOT OPEN



**CAUTION:** TO REDUCE THE RISK OF ELECTRIC SHOCK,  
DO NOT REMOVE COVER (OR BACK).  
NO USER-SERVICEABLE PARTS INSIDE.  
REFER SERVICING TO QUALIFIED SERVICE PERSONNEL.

**WARNING:** To reduce the risk of fire or electric shock, do not expose this appliance to rain or other moisture.

**CAUTION:** Changes or modifications not expressly approved by the manufacturer may void the user's authority to operate this equipment.

## For the customers in Canada

This class B digital apparatus complies with Canadian ICES-003.



The lightning flash with arrowhead symbol, within an equilateral triangle, is intended to alert the user to the presence of uninsulated "dangerous voltage" within the product's enclosure that may be of sufficient magnitude to constitute a risk of electric shock to persons.



The exclamation point within an equilateral triangle is intended to alert the user to the presence of important operating and maintenance (servicing) instructions in the literature accompanying the product.

This equipment has been tested and found to comply with the limits for a Class B digital device, pursuant to part 15 of the FCC Rules. These limits are designed to provide reasonable protection against harmful interference in a residential installation. This equipment generated, uses and can radiate radio frequency energy and, if not installed and used in accordance with the instructions, may cause harmful interference to radio communications. However, there is no guarantee that interference will not occur in a particular installation. If this equipment does cause harmful interference radio or television reception, which can be determined by turning the equipment off and on, the user is encouraged to try to correct the interference by one or more of the following measures:

- Reorient or relocate the receiving antenna.
- Increase the separation between the equipment and receiver.
- Connect the equipment into an outlet on a circuit different from that to which the receiver is connected.
- Consult the dealer or an experienced radio/TV technician for help.

# PRECAUTIONS

## Location

For safe operation and satisfactory performance of your VCR, keep the following in mind when selecting a place for its installation:

- Shield it from direct sunlight and keep it away from sources of intense heat.
- Avoid dusty or humid places.
- Avoid places with insufficient ventilation for proper heat dissipation. Do not block the ventilation holes of the VCR. Do not place the unit on a carpet because this will block the ventilation holes.
- Install the VCR in a horizontal position only.
- Avoid locations subject to strong vibrations.
- Avoid moving the VCR between cold and hot locations (see "Moisture Condensation Problems", this page).
- Do not place the VCR directly on top of the TV, as this may cause playback or recording problems.

## Avoiding Electrical Shock and Fire

- Do not handle the power cord with wet hands.
- Do not pull on the power cord when disconnecting it from an AC wall outlet. Grasp it by the plug.
- If any liquid is spilled on the VCR, unplug the power cord immediately and have the unit inspected at a factory-authorized service center.
- Do not place anything directly on top of this VCR.

## Moisture Condensation Problems

### Cause:

When the VCR is first installed, moved from a cold area to a warm area or placed in a location with high humidity, dew (moisture) may form in the unit. The Dew indicator (d d d d) blinks. If you operate the VCR with dew inside, damage may result.

### Prevention:

- ❶ Make all necessary connections.
- ❷ Plug the power cord into a 120 V AC wall outlet.
- ❸ Do not operate the VCR for approximately 2 hours.

When the VCR reaches room temperature, the Dew indicator (d d d d) will turn off and the VCR will be ready to operation.

# CONTENTS

PRECAUTIONS .....	1
FEATURES .....	3
ACCESSORY .....	3
LOCATIONS OF CONTROLS AND INDICATORS .....	4
CONNECTIONS .....	8
ON-SCREEN MENUS .....	9
SETTING THE LANGUAGE AND CLOCK .....	11
CHANGING THE ON-SCREEN DISPLAY .....	13
VIDEO CASSETTE TAPES .....	14
TAPE MANAGEMENT FUNCTION .....	16
NORMAL RECORDING .....	19
AUTOREPEAT RECORDING .....	23
ALARM RECORDING .....	24
PROGRAM TIMER RECORDING .....	27
SERIES RECORDING .....	31
NORMAL PLAYBACK .....	33
SPECIAL PLAYBACK .....	34
DAY/TIME SEARCH .....	35
SETTING THE SECURITY LOCK .....	35
SETTING THE BUZZER .....	36
CLOCK ADJUSTMENT .....	36
SETTING THE CASSETTE EJECT MODE .....	37
SETTINGS FOR RS485 TERMINALS USE .....	38
CHECKING POWER FAILURE, FAILURE DUE TO CONDENSATION AND USAGE DURATION .....	39
OUTPUT TERMINALS .....	40
MAINTENANCE .....	44
TROUBLESHOOTING GUIDE .....	46
SPECIFICATIONS .....	47
WARRANTY .....	48

# FEATURES

- Tape management function
- Clog detection
- High-speed Fast Forward/Rewind
- Field recording/playback
- 8, 24 and 40-hour mode recording (T-160)
- 6, 18 and 30-hour mode recording (T-120)
- In 8, 24, 40-hour modes audio recording is available (T-160)
- In 6, 18, 30-hour modes audio recording is available (T-120)
- Autorepeat recording
- Series recording function
- Alarm recording function
- On-screen mode setting
- Integrated time date generator
- Day/Time search function
- Alarm search and Alarm scan function
- Forward/Reverse field advance function
- 30-day memory backup
- Security lock
- Recording check function
- Automatic head cleaning function

When using the optional RS-485 board, the VCR can be controlled from a special controller.

# ACCESSORY

Power cord

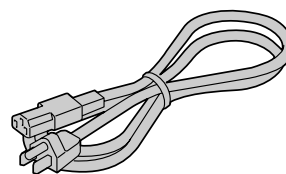

# LOCATIONS OF CONTROLS AND INDICATORS

## Front Panel

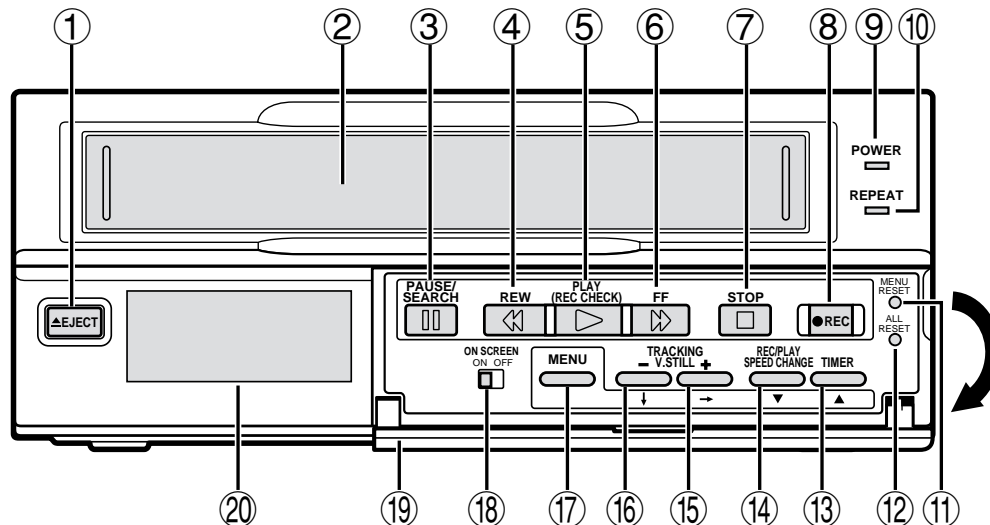

- ① **EJECT** button
- ② Cassette loading slot
- ③ **PAUSE/SEARCH** button
- ④ **REW** (rewind) button
- ⑤ **PLAY (REC CHECK)** button
- ⑥ **FF** (fast forward) button
- ⑦ **STOP** button
- ⑧ **REC** (record) button
- ⑨ **POWER** indicator
- ⑩ **REPEAT** (autorepeat recording) indicator
- ⑪ **MENU RESET** button
- ⑫ **ALL RESET** button
- ⑬ **TIMER, ▲** button
- ⑭ **REC/PLAY SPEED CHANGE, ▼** button
- ⑮ **TRACKING/V. STILL +, →** button
- ⑯ **TRACKING/V. STILL -, ↓** button
- ⑰ **MENU** button  
Press this button to display the menu.  
Buttons ⑬, ⑭, ⑮ and ⑯ are used for menu control.
- ⑱ **ON SCREEN** switch
- ⑲ Front door
- ⑳ Digital display panel

# LOCATIONS OF CONTROL

## Digital Display

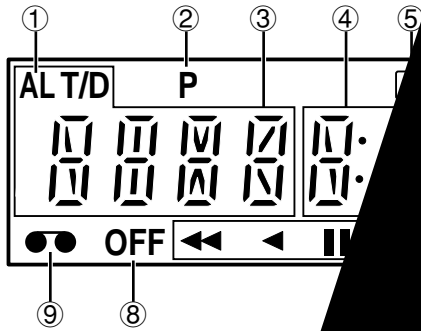

### ① Alarm indicator

Flashes when an alarm is being recorded:

Comes on after the alarm has been recorded

Indicator

Comes on when the security lock is engaged.

Comes on when the security lock is engaged.

### ⑦ Operation Indicators

- They display the actual operation mode.

Operation Mode	Indicator
Record (REC)	
Record pause (REC PAUSE)	
Playback (PLAY)	
Still image (STILL)	
Fast forward (FF)	
Rewind (REW)	
Forward picture search	
Reverse picture search	
Forward field advance	
Reverse field advance	

- Clog detection indicator

Flashes when the recording quality deteriorates due to worn VCR heads.

Flashes after

# LOCATIONS OF CONTROLS AND INDICATORS

## Back Panel

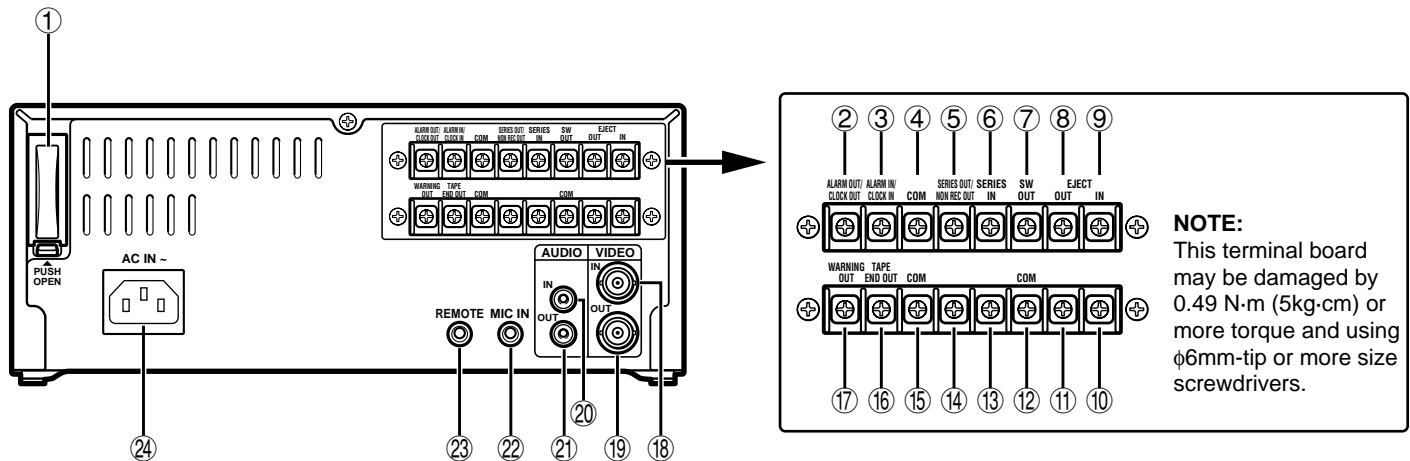

- ① Battery compartment
- ② ALARM OUT/CLOCK OUT (alarm output/external clock set trigger output) terminal
- ③ ALARM IN/CLOCK IN (alarm input/ external clock set trigger input) terminal
- ④ COM (common) terminal
- ⑤ SERIES OUT/NON REC OUT (series recording trigger output/non recording output) terminal
- ⑥ SERIES IN (series recording trigger input) terminal
- ⑦ SW OUT (switch output) terminal
- ⑧ EJECT OUT (eject trigger output) terminal
- ⑨ EJECT IN (eject trigger input) terminal
- ⑩ Do not use
- ⑪ Do not use
- ⑫ COM (common) terminal
- ⑬ Do not use
- ⑭ Do not use
- ⑮ COM (common) terminal
- ⑯ TAPE END OUT (tape end output) terminal
- ⑰ WARNING OUT (warning output) terminal
- ⑱ VIDEO IN (video input) jack
- ⑲ VIDEO OUT (video output) jack
- ⑳ AUDIO IN (audio input) jack
- ㉑ AUDIO OUT (audio output) jack
- ㉒ MIC IN (microphone input) jack
- ㉓ REMOTE (remote control input) jack
- ㉔ AC Power input

## LOCATIONS OF CONTROLS AND INDICATORS

### Back Panel (With the optional RS-485 board)

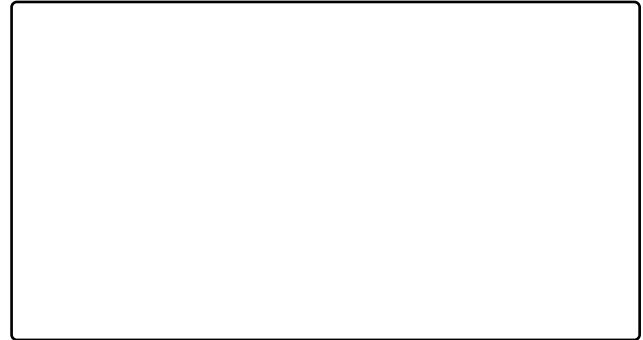
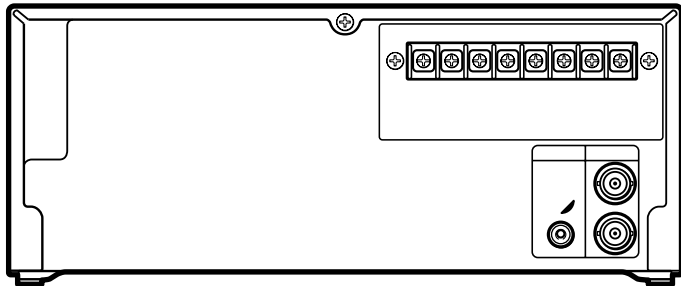

- ① Battery compartment
- ② ALARM OUT/CLOCK OUT (alarm output/external clock set trigger output) terminal
- ③ ALARM IN/CLCOK IN (alarm input/ external clock set trigger input) terminal
- ④ COM (common) terminal
- ⑤ SERIES OUT/NON REC OUT (series recording trigger output/non recording output) terminal
- ⑥ SERIES IN (series recording trigger input) terminal
- ⑦ SW OUT (switch output) terminal
- ⑧ EJECT OUT (eject trigger output) terminal
- ⑨ EJECT IN (eject trigger input) terminal
- ⑩ RS485 B terminal
- ⑪ RS485 A terminal
- ⑫ COM (common) terminal
- ⑬ RS485 B terminal
- ⑭ RS485 A terminal
- ⑮ COM (common) terminal
- ⑯ TAPE END OUT (tape end output) terminal
- ⑰ WARNING OUT (warning output) terminal
- ⑱ VIDEO IN (video input) jack
- ⑲ VIDEO OUT (video output) jack
- ⑳ AUDIO IN (audio input) jack
- ㉑ AUDIO OUT (audio output) jack
- ㉒ MIC IN (microphone input) jack
- ㉓ REMOTE (remote control input) jack
- ㉔ AC Power input



# CONNECTIONS

Connect the video camera and monitor TV as shown in the figure below.

**NOTE:** Before making the connections, make sure all the devices are disconnected from the power outlet.

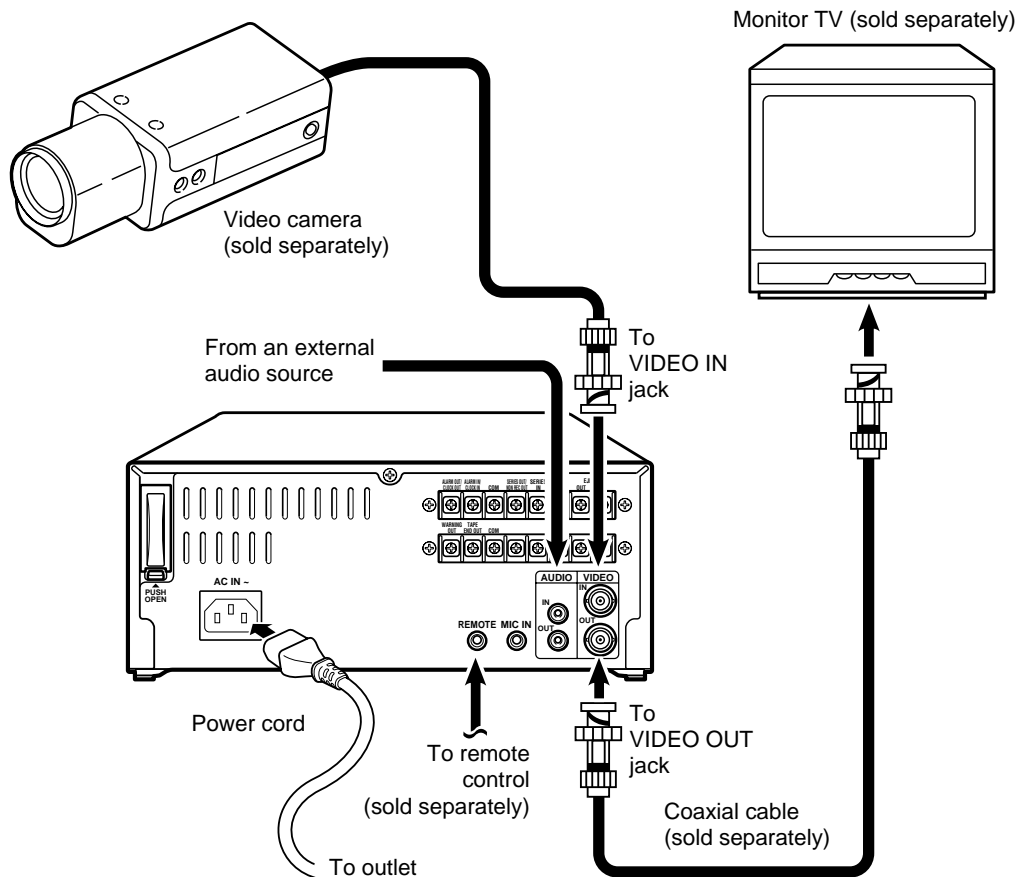

## Power Cord Installation

- 1 Plug the supplied power cord firmly into the AC power input **AC IN~** socket.
- 2 Insert the plug of this power cord into a outlet.

## NOTES:

- For more details, please refer to the manuals accompanying all other devices. If the connections are not made properly, it may cause a fire or damage the equipment.
- You can use a VA-RMN01 Remote Control Unit (sold separately) to control remotely the VCR.
- The grounded power cord (3 pin plug) must be connected to a grounded power outlet.
- If there is no video signal when the power is turned on, "NO VIDEO" will be displayed on-screen.

# ON-SCREEN MENUS

- ① When no menu is displayed on-screen, press the **MENU** button.
- The (SET UP 1) menu appears.
  - Press the **MENU** button to save any setting made and switch menu screens.

## NOTES:

- If the (POWER FAILURE)/(DEW)/(USED TIME) menu is displayed, pressing the **MENU** button will return to the monitor screen display.
- Press the **MENU** button to save any setting made and switch menu screens.
- Press the **PAUSE/SEARCH** to save the settings and return to the monitor screen.
- Within a menu, press the ↓ (or →) button to move the selection to the desired setting, then press the ▼ (or ▲) button to enter or modify the setting.

### → button

When a menu is displayed, press this button to move the cursor right.

### ↓ button

When a menu is displayed, press this button to move the cursor left.

### ▼ (or ▲) button

When a setting is selected within a menu, press this button to modify (decrease (or increase)) the setting or the numerical value.

## Types of On-screen Display and Display Sequence

Reference pages are shown in square brackets.

### SET UP 1 menu

<SET UP 1>		[11, 12]
*LANGUAGE-LANGUE-IDIOMA	ENGLISH	
*CLOCK SET	01-01-2000 SAT 00:00:00	
*DAYLIGHT SET	NO USE	
	WEEK MONTH TIME	
ON	1ST-SUN 04 02:00	
OFF	LST-SUN 10 02:00	

### SET UP 2 menu

<SET UP 2>		[13, 36]
*DISPLAY		
DATE	Y	
TIME	Y	
ALARM COUNT	Y	
SPEED	Y	
*BUZZER		
ALARM IN	Y	
TAPE END	Y	
KEY IN	N	
WARNING	Y	

### SET UP 3 menu

<SET UP 3>		[24, 33, 36, 15, 22, 40, 20, 31]
*ALARM MODE	Y1	
*ALARM SPEED	8H	
*ALARM DURATION	20S	
*VERTICAL SYNC	Y	
*EXT TIME ADJ.	01:00	
*TAPE IN MODE	STOP	
*TAPE END MODE	REW	
*TAPE END OUT	-3M	
*CLOG DETECT.	Y	
*SERIES REC IN	N	

### SET UP 4 menu

<SET UP 4>		[40, 15, 21, 37]
*SW OUT		
TIMING	FIELD	
FIELD	01	
8H	Y	
*THREAD CHECK	Y	
*VIDEO LOSS	N	
*REC SPEED	N	
*EJECT SET		
EJECT MODE	EJECT1	
OPERATION	SLAVE	

### SET UP 5 menu

<SET UP 5>		[41, 43, 42, 15]
*INPUT OUTPUT ALARM		
*OUTPUT	SERIES	
*WARN. OUT	TRANSPORT	
*REMOTE	EJECT	
*TAPE	T-160	

### SET UP 6 menu

<SET UP 6>		[38]
*RS485		
ADDRESS	000	
TERMINATE	N	
DATA SPEED	19200	
STATUS INFO	Y	
ALARM INFO	Y	

# ON-SCREEN MENUS

## TAPE MANAGEMENT menu

<TAPE MANAGEMENT>		[16-18]
*TAPE MANAGE.	N	
*PROTECT DAY	30	
*REC PASS SET	10	
*GROUP NO.	OFF	
*OVERRIDE	N	

## TIMER SET menu

<TIMER SET>				[27-30]
WEEK	START	STOP	SPD	
SUN	---:--	---:--	----	N
MON	---:--	---:--	----	N
TUE	---:--	---:--	----	N
WED	---:--	---:--	----	N
THU	---:--	---:--	----	N
FRI	---:--	---:--	----	N
SAT	---:--	---:--	----	N
DLY	---:--	---:--	----	N

## HOLIDAY SET menu

<HOLIDAY SET>				[29]
1	----	11	----	
2	----	12	----	
3	----	13	----	
4	----	14	----	
5	----	15	----	
6	----	16	----	
7	----	17	----	
8	----	18	----	
9	----	19	----	
10	----	20	----	

## ALARM TIME menu

<ALARM TIME>		[25]
000	---:--:--	
	---:--:--	
	---:--:--	
	---:--:--	
	---:--:--	
	---:--:--	
	---:--:--	
	---:--:--	

## POWER FAILURE/DEW/USED TIME menu

<POWER FAILURE>		[39]
000	FAILURE ----:--	
	RECOVERY ----:--	
<DEW>		
000	FAILURE ----:--	
	RECOVERY ----:--	
<USED TIME>		
VIDEO	00000H	
POWER	00000H	

## NOTES:

- When a menu is displayed, recording will not be possible.
- During recording or playback the menus cannot be displayed.
- To reset the settings of a menu to their original values, select the desired menu then press the **MENU RESET** button. The (USED TIME) menu data cannot be reset.
- The (SET UP 6) menu will only be displayed when the optional RS-485 board is installed.

# SETTING THE LANGUAGE AND CLOCK

## Language Setting

English, French or Spanish can be selected by the user.

- 1 Turn the power on to all devices used.
- 2 Press the **MENU** button to display the (SET UP 1) menu.

```
<SET UP 1>
*LANGUAGE-LANGUE-IDIOMA
ENGLISH

*CLOCK SET
01-01-2000 SAT 00:00:00

*DAYLIGHT SET NO USE
WEEK MONTH TIME
ON 1ST-SUN 04 02:00
OFF LST-SUN 10 02:00
```

- 3 Press the ▼ (or ▲) button to select the language of your choice.
- 4 Press the **PAUSE/SEARCH** button to save the settings.

## Clock setting

**Example:** To set the clock to October 15, 2001 at 3:20 PM (15:20).

- 1 Press the **MENU** button to display the (SET UP 1) menu.
- 2 Press the ↓ button, until the "CLOCK SET" setting is flashing.
- 3 Press the ▼ (or ▲) button to set the month (ex: 10), then press the → button.
  - o *The day of week is set automatically.*
- 4 Press the ▼ (or ▲) button to set the day (ex: 15), then press the → button.
- 5 Press the ▼ (or ▲) button to set the year (ex: 2001), then press the → button.
- 6 Press the ▼ (or ▲) button to set the hours (ex: 15 for 3 PM), then press the → button.
- 7 Press the ▼ (or ▲) button to set the minutes (ex: 20), then press the → button.

```
<SET UP 1>
*LANGUAGE-LANGUE-IDIOMA
ENGLISH

*CLOCK SET
10-15-2001 MON 15:20:00

*DAYLIGHT SET NO USE
WEEK MONTH TIME
ON 1ST-SUN 04 02:00
OFF LST-SUN 10 02:00
```

- 8 For accurate clock setting, press the ▼ button together with a time broadcast, or other accurate time signal, this will start the seconds counting from 00.
- 9 Press the **PAUSE/SEARCH** button.
  - o *The setting procedure is now completed.*

## NOTES:

- Clock display is only 24 hours.
- In STOP mode, press and hold the **STOP** button then press the **TRACKING/V.STILL-** button to reset the minutes and seconds to 00 (to the closest hour). For example, between 13:30:00 and 14:29:59 the clock is reset to 14:00:00.

# SETTING THE LANGUAGE AND CLOCK

## Automatic Daylight Saving Time Adjustment

- 1 Press the **MENU** button to display the (SET UP 1) menu.

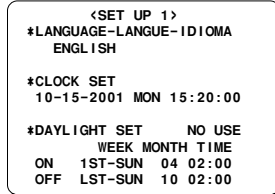

- 2 Press the **↓** button, until the “DAYLIGHT SET” setting is flashing.
- 3 Press the **▼** (or **▲**) button to set the auto daylight saving time/standard time adjustment.
  - NO USE . . . . . No daylight saving time/standard time adjustment is made.
  - USE . . . . . The auto daylight saving time/standard time adjustment is made.
- 4 Press the **↓** button until “1ST” of the “ON” line is flashing.
- 5 Set the day the daylight saving time adjustment is made.
  - Press the **▼** (or **▲**) button to set the week, then press the **→** button.  
1ST, 2ND, 3RD, 4TH or LST (first, second, third, fourth or last)
  - Press the **▼** (or **▲**) button to set the day of week, then press the **→** button.  
SUN, MON, TUE, ..... SAT (Sunday, Monday, Tuesday....Saturday)
- 6 Press the **▼** (or **▲**) button to set the month the daylight saving time adjustment is made, then press the **→** button.  
01, 02,.....11, 12 (for January, February.....November, December)
- 7 Press the **▼** (or **▲**) button to set the time the daylight saving time adjustment is made.
- 8 Press the **↓** button until “LST” of the “OFF” line is flashing.
- 9 Following the same procedure as above (steps **5** to **7**), set when the time is changed back from daylight saving time to standard time.
- 10 Press the **PAUSE/SEARCH** button to save the setting.

# CHANGING THE ON-SCREEN DISPLAY

## Selecting the On-screen Display

You can select to display or not the date, time, the number of alarm recordings and tape speed.

- 1 Turn the power on to all devices used.
- 2 Press the **MENU** button until the (SET UP 2) menu is displayed.

<SET UP 2>	
*DISPLAY	
DATE	Y
TIME	Y
ALARM COUNT	Y
SPEED	Y
*BUZZER	
ALARM IN	Y
TAPE END	Y
KEY IN	N
WARNING	Y

- 3 Press the ↓ button, until the desired item for which the display function will be set is flashing.
- 4 Press the ▼ (or ▲) button to set “Y” for the functions described below.
  - DATE . . . . . The date is displayed
  - TIME . . . . . The time is displayed
  - ALARM COUNT. . . . . The number of alarm recordings is displayed
  - SPEED. . . . . The recording/playback speed mode is displayed
- 5 Press the **PAUSE/SEARCH** button to save the settings.

### NOTE:

- If the **ON SCREEN** switch is set to the “ON” position, the items for which “Y” is set are recorded. The items for which “N” was set at step 4 above are not recorded.

## Changing the Date/Time Display Position

- 1 Turn the power on to all input devices to the VCR.
- 2 Set the **ON SCREEN** switch to the “ON” position.
  - The date and time are displayed.

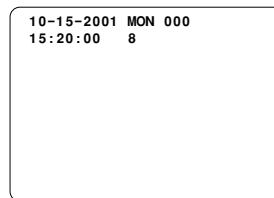

- 3 Press the → (or ↓) button.
  - The display will move towards the right (or the bottom).

### NOTES:

- If the → (or ↓) button is kept pressed for 1 second or more the display will move at a faster speed.
- The display position cannot be changed while recording.

# VIDEO CASSETTE TAPES

Use only video cassette tapes bearing the **VHS** logo. This VCR was primarily designed for use with T-120 or T-160 cassette tapes, it is recommended to use T-120 or T-160 standard grade VHS video cassette tapes for optimal performance.

## Handling Cassette Tapes

The cassette tapes should always be stored vertically, in their cases, away from high temperatures, magnetic fields, direct sunlight, dirt, dust and locations subject to mold formation.

Do not tamper with the cassette mechanism and never touch the tape with your fingers.

Protect the cassette tapes from shocks or strong vibrations.

## To Protect your Recordings

After having recorded a tape, if you wish to keep the recording, use a flathead screwdriver to break off the erasure-prevention tab on the cassette.

To record again on a tape without erasure-prevention tab, cover the hole with adhesive tape.

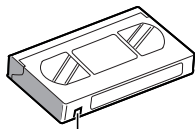

Erase-prevention tab

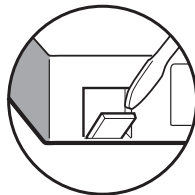

## Precautions concerning the video cassette tapes

- Do not use tapes that are damaged, tapes that have been cut and repaired or tapes that have been altered in any way.
- Some rewinders may entangle the tape, and therefore their use is not recommended.
- When tapes are recorded over and over again, the recording quality will deteriorate. Refer to "Concerning the Number of Times Tapes can be Rerecorded on" on page 20, and replace the tape with a new tape as required.

## Loading

- ① Place the cassette, label side up, in the loading slot. Gently push the center of the cassette until it is loaded automatically.

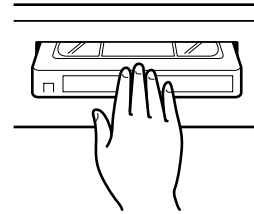

- The time display will switch to the reset counter "0:00:00" display.
- After the cassette tape is loaded, a mechanism will operate for about 12 seconds to check that the tape has been threaded correctly and the cassette indicator "●●" will blink during that period.
- When the cassette is loaded, if the tape has been threaded correctly, the cassette indicator "●●" will light on the digital display.

### NOTE:

- If you try to record on a cassette without erasure-prevention tab, the VCR will eject the cassette.

## Unloading

- ① In stop mode, press the **EJECT** button.
  - The cassette is automatically ejected.

### NOTES:

- Do not insert any object in the cassette loading slot, as that may cause injury and damages to the VCR.
- If your hand gets stuck in the cassette loading slot, unplug the power cord and consult the dealer where the unit was bought. Do not forcibly pull the hand out as that may cause severe injuries.

## Action to Take When Tapes are Loaded

In the (3) menu, you can set the action to take when a cassette is loaded.

Press the **MENU** button until the (SE

<SET UP 3>	
*ALARM MODE	Y1
*ALARM SPEED	8H
*ALARM DURATION	20S
*VERTICAL SYNC	Y
*EXT TIME ADJ.	01:
*TAPE IN MODE	ST
*TAPE END MODE	
*TAPE END OUT	
*CLOG DETECT.	
*SERIES REC IN	

button, until

(or ▲)

PA

### Setting the T

Press the **ME** button until the **ME** is displayed.

② Press the **↓** button until the **ME** is flashing.

③ Press the **→** button until the **ME** is displayed.

check”

red mode.

hread check

ape thread check

off

button to save the set



# TAPE MANAGEMENT FUNCTION

This VCR is equipped with a tape management function. Using this function you can protect previous recordings and prevent overuse of the tape by controlling the tape protection term (number of days), the maximum number of re-recordings of the tape and the recording group. To use the tape management function, it must be set before recording is started. The tape management data is recorded at the beginning of the tape. For details on how to set this function, refer to "Setting the Tape Management Function".

**PROTECT DAY:** To set the number of days before the tape can be rerecorded over.

**REC PASS SET:** To limit the number of rerecordings, in order to maintain a good image quality.

**GROUP NO.:** To manage tapes belonging to different recording groups.

## NOTE:

- Before using this function, make sure that the clock is set properly.

## Operation

When recording is started, the VCR will rewind the tape to the beginning, and will playback some of the tape to check for the presence of tape management data (no image is displayed). While the presence and type of data are checked, the message "T. MANAGE. CHK" is displayed on-screen.

## NOTES:

- When a program timer recording is set, the tape management data is checked after the **TIMER** button is pressed to complete the program timer recording setting.
- During alarm recording, the tape management function will not operate even if it is active.

## If no tape management data is present on the tape

Recording will start according to the settings in the (TAPE MANAGEMENT) menu.

When recording starts, the updated tape management data is recorded onto the tape.

If the tape has already been recorded on, the message "USED TAPE" will flash on-screen until recording starts.

## If tape management data is present on the tape

The tape management data is checked and if there is no conflict, the VCR will rewind the tape to the beginning, then recording starts and the updated tape management data is recorded onto the tape. While the tape is rewound and the tape management data recorded, the message "T. MANAGE. OK" is displayed on-screen.

If a conflict is found when the tape management data is checked, the (TAPE MANAGEMENT) menu is displayed and the conflicting setting will flash. This menu will show the settings taken from the data recorded on the tape and not the current data settings held in the VCR's (TAPE MANAGEMENT) menu setting. Refer to "Tape Management Conflict Display" for detailed information.

## NOTES:

- During Autorepeat recording, the tape management data at the beginning of the tape will be checked and updated every time the tape is rewound to the beginning. However, the "PROTECT DAY" setting will be ignored. Also, even if there is a conflict with the "REC PASS SET" number, autorepeat recording will continue without any warning.
- If the VCR is set for alarm recordings, alarm recording will be done based on the different settings.

If an alarm trigger is received while the tape is being first rewound, the tape will continue to be rewound to the beginning, then alarm recording will be done after the tape has been advanced of a preset duration.

If an alarm trigger is received while the message "T. MANAGE. CHK" is displayed on-screen, in order to prevent erasing the tape management data recorded at the beginning of the tape, the tape is advanced of a preset duration, then alarm recording starts.

If an alarm trigger is received while tape management data is being recorded onto the tape, alarm recording will only start after all the data has been recorded.

Furthermore, when setting a program timer recording, in order to protect the data, no alarm trigger will be received until the first program timer recording starts.

## IMPORTANT NOTES:

- If the tape management data cannot be read, the VCR will switch to stop mode and "INCORRECT DATA" will be displayed on-screen. This may indicate that the beginning of the tape (data recording/reading section) is damaged and the tape may be unusable. The message "INCORRECT DATA" will disappear when the **EJECT**, **STOP** or **PLAY** button is pressed.
- **Set the security lock function to on in order to protect the security of this feature.**

# TAPE MANAGEMENT FUNCTION

## Setting the Tape Management Function

- 1 Press the **MENU** button until the (TAPE MANAGEMENT) menu is displayed.

<TAPE MANAGEMENT>	
*TAPE MANAGE.	N
*PROTECT DAY	30
*REC PASS SET	10
*GROUP NO.	OFF
*OVERRIDE	N

- 2 Press the ▼ (or ▲) button to select the desired mode.

N . . . . . The tape management function is not active.

Y . . . . . The tape management function is active.

When setting to "Y", please continue with the settings below.

- 3 Press the ↓ button, until the "PROTECT DAY" setting is flashing.

- 4 Press the ▼ (or ▲) button to select the desired number of days to protect the tape.

OFF . . . . The tape is not protected.

1-255 . . . Number of days to protect the tape (prevent over-recording), from the date of the last recording on the tape (or the last expected recording date (calculated using the tape length (T-120 or T-160) and the recording speed).

### NOTES:

- Since the last expected recording date is a calculated date (using the tape length (T-120 or T-160) and the recording speed), it may be different from the actual last recording date, this due to other settings such as (alarm recordings, program timer recordings, holiday settings).
  - When setting a program timer recording, the tape protection term is checked when the VCR is set to program timer recording stand-by mode.
  - When a program timer recording is done, the data is updated when recording starts. Even if the recording is stopped before the programmed time, the original data (last expected recording date) will remain as calculated.
- 5 Press the ↓ button, until the "REC PASS SET" setting is flashing.
  - 6 Press the ▼ (or ▲) button, to select the desired number of re-recording times.

OFF . . . . The number of re-recording times will not be checked.

1-100 . . . Maximum number of re-recording times.  
(Refer to "Concerning the Number of Times Tapes can be Rerecorded on" on page 20.)

### NOTES:

- The data is updated at the beginning of the recording. Even if the recording is stopped before the end, the original data information will be considered.
  - During Autorepeat recording, the re-recording times count will be updated every time the tape is rewound to the beginning. Autorepeat recording will proceed even if the count exceeds the "REC PASS SET" setting. If in the BUZZER section WARNING is set to "Y", the buzzer is heard.
- 7 Press the ↓ button, until the "GROUP NO." setting is flashing.
  - 8 Press the ▼ (or ▲) button, to select the desired group number.

OFF . . . . The group number will not be checked.

1-15 . . . . Group number setting.
  - 9 Press the ↓ button, until the "OVERRIDE" setting is flashing.
  - 10 Press the ▼ (or ▲) button, to select the desired override mode.

Y . . . . . In case of a conflict that prevents recording, the next operation is executed. If recording is done, then the last recording date and the re-recording times count are updated.

N . . . . . In case of a conflict that prevents recording, the (TAPE MANAGEMENT) menu is displayed and the conflicting setting preventing recording will flash. The only possible action is to press the **EJECT** button, in order to eject the tape. (Refer to "Tape Management Conflict Display".)
  - 11 Press the **PAUSE/SEARCH** button to save the settings.

### NOTES:

- **Once the tape management data is recorded on tape, it cannot be changed.**
- The criteria (condition) for allowing recording will be based on the data recorded on the tape and not the settings in the (TAPE MANAGEMENT) menu.

# TAPE MANAGEMENT FUNCTION

## Tape Management Conflict Display

If when the tape management function checks the tape data a conflict that prevents recording is found, the (TAPE MANAGEMENT) menu is displayed with the conflicting setting flashing and the VCR go into the stop mode. If in the (SET UP 2) menu, in the BUZZER section WARNING is set to "Y", the buzzer is heard. (To stop the buzzer, press the **STOP** button.)

### NOTES:

- If "OVERRIDE" is set to "N" (No), the conflicting setting is displayed flashing and the message (PRESS EJECT) is displayed at the bottom of the screen. Recording under these conditions is not possible. Press the **EJECT** button to eject the tape. To record on the same tape, set the OVERRIDE setting to "Y" and modify the conflicting setting, then insert the same tape and press the **REC** button. However, if only "PROTECT DAY" and "REC PASS SET" are modified, the menu will be displayed again. Press the **REC** button one more time to start recording. Recording starts and the tape data is updated.

### Conflict display sample

<TAPE MANAGEMENT>	
*TAPE MANAGE.	N
*PROTECT DAY	30
LAST M/D	NEXT M/D
10/15	11/15
*REC PASS SET	10
PASS COUNT	10
*GROUP NO.	7
REC GR. NO.	8
*OVERRIDE	N
(PRESS EJECT)	

- If the "OVERRIDE" is set to "Y" (Yes), the (TAPE MANAGEMENT) menu is displayed and conflicting setting preventing recording will flash and VCR go into the stop mode.  
To enter the record mode, press the **REC** button.

## PROTECT DAY CONFLICT

The tape is protected, the tape protection term (ex. 30 days) is not yet over.

Under LAST M/D, the date of the last recording on the tape (or the last expected recording date (calculated using the tape length (T-120 or T-160) and the recording speed)) is displayed.

Under NEXT M/D, the date when it will be possible to record on the tape again is displayed.

## REC PASS SET CONFLICT

The set number of recording passes has been reached.

The PASS COUNT shows the number of recording passes on the tape (ex. since the maximum number of recording passes is set to "10", this prevents further recording.)

### NOTES:

- When conducting Autorepeat recording, if the PASS COUNT exceeds 100, "101\*" will be displayed flashing.
- If using a tape recorded previously on a different type of VCR (no tape data), when the set number of recordings is exceeded, "USED" will flash next to the PASS COUNT number.

## GROUP NO. CONFLICT

The group numbers do not match.

The REC GR. NO. shows the tape recording group number (ex. this tape belongs to a different recording group number 8 than the one set 7.)

# NORMAL RECORDING

## Normal Recording

### Before starting

- Turn the power on to all devices used.
- Select the "TAPE" in the (SET UP 5) menu according to the type of the tape used.
- Load a cassette tape with erasure-prevention tab.

### NOTE:

- If in the (SET UP 3) menu, TAPE IN MODE is set to "REC", recording will start after the tape thread has been checked.
- Set the **ON SCREEN** switch to the "ON" position.

❶ Press the **REC/PLAY SPEED CHANGE** button to set the recording speed mode.

- *The recording speed mode is displayed on-screen and on the digital display.*

❷ Press the **REC** button.

- *The record indicator "●" light.*
- *Recording starts.*
- *If the tape end is reached while recording, "OFF" is displayed on the digital display and the unit goes into the mode set at the "TAPE END MODE" line in the (SET UP 3) menu.*

### NOTES:

- If in the (SET UP 2) menu, in the BUZZER section TAPE END is set to "Y", the buzzer will be heard as long as "OFF" is displayed on the digital display.
- To cancel the "OFF" display, press the **STOP**, **EJECT**, **FF**, **REW** or **PLAY** button.

❸ To stop recording, press the **STOP** button.

### NOTES:

- A tape recording made on this VCR may not play back with the same degree of clarity on a real time video recorder from another manufacturer.
- If you press on the **REC** button and the loaded cassette has no erasure-prevention tab, the VCR will eject the cassette.

## [Recording Speed Mode]

(When "TAPE" in the (SET UP 5) menu is set to "T-160")

Recording speed mode (hour mode)	Maximum recording duration (hours)	Recording interval (second)	Audio recording	Tape motion
8	8	1/60	Possible	Continuous
24	24	3/60		
40	40	5/60		

(When "TAPE" in the (SET UP 5) menu is set to "T-120")

Recording speed mode (hour mode)	Maximum recording duration (hours)	Recording interval (second)	Audio recording	Tape motion
6	6	1/60	Possible	Continuous
18	18	3/60		
30	30	5/60		

### NOTE:

- The tape speed display will vary according to the "TAPE" setting in (SET UP 5) menu setting. In this manual, all the examples and displays used are for when "TAPE" is set to "T-160". If set to "T-120", please refer to the table above for the corresponding duration and displays.  
For example, if the recording speed mode is "8", then the corresponding recording speed when set to "T-120" will be "6". And, the counter reading of 7:57:00 will be 5:57:00 when set to "T-120".

# NORMAL RECORDING

## Concerning the Number of Times Tapes can be Rerecorded on

Depending on the recording speed mode, the tape must be replaced after a certain number of recording times.

Refer to the table below for the maximum number of times a tape can be recorded on.

Recording speed mode (hour mode)	Maximum number of recording times (with a standard grade tape)
6, 8	100
18, 24	50
30, 40	50

### NOTES:

- The maximum number of recording times will vary depending on the location and kind of tape used. Verify the recording quality and replace the tape when the quality starts to deteriorate. The maximum number of recording times indicated above are based on test tapes (T-120 or T-160) used by the company.
- If using longer tapes (i.e. T-180) the tape travel will not be as stable and that may cause problems.

## Record Pause

Recording can be interrupted temporarily.

- 1 Press the **PAUSE/SEARCH** button during recording.
  - The *Pause/Still* indicator “||” blinks.

### NOTES:

- The image appears on-screen but it is not recorded.
  - If a recording pause continues for 5 minutes or more, the VCR will go into stop mode to avoid damaging the tape.
- 2 To resume recording, press the **REC** button, or press the **PAUSE/SEARCH** button again.

## Recording Check

The image being recorded can be checked.

- 1 During recording, press the **PLAY (REC CHECK)** button.
  - The *tape will be rewound and then played back.*  
*The VCR will then return to the previous recording mode.*

### NOTE:

- During recording check operations, recording is suspended momentarily.

## Clog Detection

This VCR is equipped with a clog detection function.

The recording quality is monitored automatically. When the heads are dirty and the recording quality deteriorates, the output at the **WARNING OUT** terminal becomes 0V (Low), the “●” indicator flashes on the digital display, and the buzzer sounds.

If in the (SET UP 3) menu, CLOG DETECT. is set to “N”, the recording quality is not monitored.

### NOTES:

- To cancel the “●” indicator display and reset the **WARNING OUT** terminal output, press the **STOP** button.
- Clog detection is not possible if recording in 8-hour mode.

# NORMAL RECORDING

## Changes to the Recording Speed Mode During Recording

It is possible to permit or prevent changing the recording speed mode during recording.

- 1 Press the **MENU** button until the (SET UP 4) menu is displayed.

<SET UP 4>	
*SW OUT	
TIMING	FIELD
FIELD	01
8H	Y
*THREAD CHECK	Y
*VIDEO LOSS	N
*REC SPEED	N
*EJECT SET	
EJECT MODE	EJECT1
OPERATION	SLAVE

- 2 Press the ↓ button, until the “REC SPEED” setting is flashing.
- 3 Press the ▼ (or ▲) button to set the desired mode.  
N . . . . . Recording speed mode can not be changed  
Y . . . . . Recording speed mode can be changed
- 4 Press the **PAUSE/SEARCH** button to save the setting.

## Action to Take when the Video Signal Deteriorates

If there is no video signal during recording, or when a menu is not displayed (in stop, fast forward, rewind modes), “VIDEO LOSS” can be displayed on-screen.

If in the (SET UP 5) menu “WARN.OUT” is set to “V.LOSS” or “T OR V”, a signal (0V) will be output at the **WARNING OUT** terminal.

If in the (SET UP 2) menu, in the BUZZER section WARNING is set to “Y”, the buzzer will be heard. To stop the buzzer, press the **STOP** button.

- 1 Press the **MENU** button until the (SET UP 4) menu is displayed.
- 2 Press the ↓ button, until the “VIDEO LOSS” setting is flashing.
- 3 Press the ▼ (or ▲) button to set the desired mode.  
N . . . . . The video loss warning is not active.  
Y . . . . . The video loss warning is active.
- 4 Press the **PAUSE/SEARCH** button to save the setting.

# NORMAL RECORDING

## Setting the Mode at the End of the Tape

In the (SET UP 3) menu, you can set the mode of the VCR mode when the tape reaches the end during recording.

- 1 Press the **MENU** button until the (SET UP 3) menu is displayed.

<SET UP 3>	
*ALARM MODE	Y1
*ALARM SPEED	8H
*ALARM DURATION	20S
*VERTICAL SYNC	Y
*EXT TIME ADJ.	01:00
*TAPE IN MODE	STOP
*TAPE END MODE	REW
*TAPE END OUT	-3M
*CLOG DETECT.	Y
*SERIES REC IN	N

- 2 Press the **↓** button, until the "TAPE END MODE" setting is flashing.
- 3 Press the **▼** (or **▲**) button to set the desired mode.
  - Setting when not using Autorepeat recording
    - REW . . . . . Rewinds the tape to the beginning, then goes to stop mode
    - STOP . . . . . Goes to stop mode
    - EJECT . . . . . The cassette is ejected
  - Setting when using Autorepeat recording
    - R1 . . . . . Autorepeat recording mode is automatically canceled if there was an alarm trigger
    - R2 . . . . . Autorepeat recording mode is active even if there was an alarm trigger
- 4 Press the **PAUSE/SEARCH** button to save the setting.

## Tape Counter Notes:

- There is no tape counter indication for the blank portions of the tape.
- In the 8-hour recording speed mode only, the tape counter indicates real hours, minutes and seconds.
- In the other recording speed modes, the tape counter indication is a ratio of the 8-hour mode base indication. (In 40-hour recording mode, each "second" of the tape counter actually represents approximately  $40/8 = 5$  real seconds.)
- There may be a slight discrepancy between the position shown on the tape counter and the actual tape position.
- When rewinding the tape past the "0:00:00" position, a minus (-) sign will be displayed.

# AUTOREPEAT RECORDING

## Autorepeat Recording

The same tape can be recorded over many times.

- Follow the **Before starting** steps, under "NORMAL RECORDING".
- ① Press the **MENU** button until the (SET UP 3) menu is displayed.

<SET UP 3>	
*ALARM MODE	Y1
*ALARM SPEED	8H
*ALARM DURATION	20S
*VERTICAL SYNC	Y
*EXT TIME ADJ.	01:00
*TAPE IN MODE	STOP
*TAPE END MODE	REW
*TAPE END OUT	-3M
*CLOG DETECT.	Y
*SERIES REC IN	N

- ② Press the ↓ button, until the "TAPE END MODE" setting is flashing.
- ③ Press the ▼ (or ▲) button to set to "R 1" or "R 2". (Please refer to page 22, "Setting the Mode at the End of the Tape.")
- ④ Press the **PAUSE/SEARCH** button to save the setting.
  - The **REPEAT** indicator will light.
- ⑤ Press the **REC/PLAY SPEED CHANGE** button to set the recording speed mode.
- ⑥ Press the **REC** button.
  - Recording will start. When the tape end is reached, the VCR will rewind it to the beginning, and recording will resume.
  - When the end of the tape is reached, a buzzer will be heard (if in the (SETUP 2) menu, in the BUZZER section TAPE END is set to "Y") and "OFF" will be displayed until the rewinding operation starts.

## NOTES:

- If during autorepeat recording there is an alarm trigger, "AL" is displayed on the digital display and alarm recording will take place. (Please refer to page 24, "ALARM RECORDING".)
- If the "TAPE END MODE" setting is R 1, the REPEAT indicator will go off if there is an alarm trigger. After alarm recording, the recording will continue to the end of the tape then it will be rewound to the beginning and stop. "OFF" will be displayed on the digital display. To turn off the buzzer (if in the (SETUP 2) menu, in the BUZZER section TAPE END is set to "Y") and the "OFF" display, press the **STOP, EJECT, FF, REW** or **PLAY** button.
- If "AL" is displayed on the digital display and the "TAPE END MODE" setting is R1, autorepeat recording is not possible.



# ALARM RECORDING

By connecting the **ALARM IN/CLOCK IN** terminal to a door switch, an interphone, etc., a recording can be done only when necessary.

## Alarm Recording Setting

Alarm recording is performed when there is an input (trigger) at the **ALARM IN/CLOCK IN** terminal, "AL" is displayed on the digital display.

- To do alarm recording, "INPUT OUTPUT" in the (SET UP 5) menu must be set to "ALARM".
  - Make all necessary connections.
  - The alarm triggers are received while in recording and stop modes.
  - Follow the **Before starting** steps, under "NORMAL RECORDING".
- 1 Press the **MENU** button until the (SET UP 3) menu is displayed.
    - The "ALARM MODE" setting is flashing.

<SET UP 3>	
*ALARM MODE	Y1
*ALARM SPEED	8H
*ALARM DURATION	20S
*VERTICAL SYNC	Y
*EXT TIME ADJ.	01:00
*TAPE IN MODE	STOP
*TAPE END MODE	REW
*TAPE END OUT	-3M
*CLOG DETECT.	Y
*SERIES REC IN	N

- 2 Press the ▼ (or ▲) button to set the desired alarm recording mode, then press the ↓ button.
  - Y1. . . . . Alarm recording is done when there is an alarm trigger.
  - Y2. . . . . Alarm recording is done only when there is an alarm trigger during programmed timer recording.
  - Y3. . . . . Alarm recording is done only if there is an alarm trigger and the VCR is not in programmed timer recording mode.
  - Y4. . . . . Alarm recording is done only when there is an alarm trigger during programmed timer recording duration. Timer recording is not possible.
  - N . . . . . Alarm recording is not performed even if there is an alarm trigger.

- 3 Press the ▼ (or ▲) button to select the desired recording speed, then press the ↓ button.
  - 8H (6H). . . . . 8-hour (6-hour) mode recording
  - 24H (18H) . . . . 24-hour (18-hour) mode recording
  - 40H (30H) . . . . 40-hour (30-hour) mode recording
  - NC . . . . . Recording at the speed already set

### NOTE:

- Indicated in brackets are the settings for when "TAPE" in the (SET UP 5) menu is set to "T-120".
- 4 Press the ▼ (or ▲) button, to select the desired alarm recording duration (20S, 40S, 1M, 2M, 3M, 4M, 5M, or CC).
    - 20S-5M. . . . . Recording only for the displayed duration
    - CC . . . . . Recording as long as the alarm signal is being input (minimum 5 seconds)
  - 5 Press the **PAUSE/SEARCH** button to save the settings.

### NOTES:

- During alarm recording all buttons are disabled.
- If "OFF" is displayed on the digital display, alarm recording is not possible in order to prevent the recorded tape to be recorded over. To cancel the "OFF" display, press the **STOP**, **EJECT**, **FF**, **REW** or **PLAY** button.
- If an alarm trigger is received while alarm recording is in progress, recording duration for the second alarm will be calculated from that point. The alarm counter will register the alarm, but it will not be found during an alarm scan and alarm search.
- If there is a power failure during alarm recording, and the power is restored within the recording set duration, alarm recording will continue.
- If the alarm recording duration is short, the alarms may not be found during an alarm scan or an alarm search. If the alarms are going to be reviewed using alarm scan or alarm search, then in 8-hour mode, 20-second or more recording duration should be used.
- To do alarm recording during series recording, set "ALARM MODE" to "Y1" or "Y3". Alarm recording will be conducted only if the VCR is recording.

# ALARM RECORDING

## Alarm Recording Counter Display

- During alarm recording, "AL" will be flashing on the digital display.
- If the **ON SCREEN** switch is set to the "ON" position, the number of alarms will flash on the monitor screen.
- The maximum display number of alarm recordings is "999", at the next alarm recording the counter will indicate "000".
- When the (ALARM TIME) menu is displayed, press the **MENU RESET** button to reset the alarm counter to "000" (all the data of the (ALARM TIME) menu is reset).

## Connections to the ALARM IN/CLOCK IN and ALARM OUT/CLOCK OUT Terminals

- Alarm input signal  
Connect a make-contact (no voltage) switch between the **ALARM IN/CLOCK IN** and **COM** terminals.
- Alarm output signal  
Normally DC 5V are output between the **ALARM OUT/CLOCK OUT** and the **COM** terminals. When an alarm input (trigger) is received and the unit is recording, the output falls to 0V. Once the alarm recording is over, the output returns to DC 5V.

## Checking the Alarm Recordings Time

- 1 Press the **MENU** button until the (ALARM TIME) menu is displayed.
  - *The number of alarm recordings, and the 8 most recent alarm recording times are displayed.*

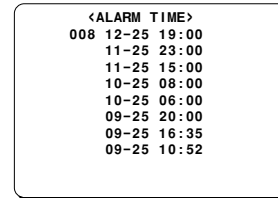

```
<ALARM TIME>
008 12-25 19:00
    11-25 23:00
    11-25 15:00
    10-25 08:00
    10-25 06:00
    09-25 20:00
    09-25 16:35
    09-25 10:52
```

### NOTE:

- The data for the previous alarm recordings is erased.

- 2 Press the **PAUSE/SEARCH** button, the normal screen is displayed.

### NOTE:

- If the **MENU RESET** button is pressed while the (ALARM TIME) menu is displayed, the displayed data is erased. "AL" will be erased from the digital display.

# ALARM RECORDING

## Alarm Search

To go to the beginning of a desired alarm recording.

- ❶ Press the **PAUSE/SEARCH** button during stop mode.
  - "AL SEARCH 01" will be displayed on screen.
- ❷ Press the ▼ (or ▲) button to set the desired alarm number (1 to 99), then press the **FF** (or **REW**) button.
  - The desired alarm is searched and a still image of the beginning of the alarm recording will appear on-screen.

### NOTE:

- The alarm number is relative to the actual tape position. (Please refer to the illustration below.)

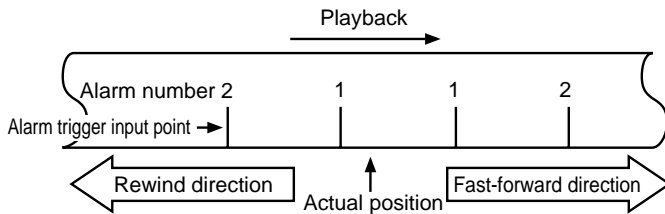

- ❸ Press the **PLAY** button.
  - Playback will start.

### NOTE:

- If during a search the end of the tape is reached, the tape will rewind and stop. If the beginning of the tape is reached, it will stop.

## Alarm Scan

To look for an alarm recording by viewing the first 5 seconds of each alarm recording.

- ❶ Press the **PAUSE/SEARCH** button twice during stop mode.
  - "AL SCAN" will be displayed on screen.
- ❷ Press the **FF** (or **REW**) button.
  - The unit will advance (or rewind) the tape at high speed and playback the first 5 seconds of every alarm recording.
  - To cancel the alarm scan mode, press the **STOP** button.
- ❸ While the desired recording is being played back, press the **PLAY** button.
  - Playback will start, alarm scan mode is cancelled.

### NOTE:

- If during a scan the end of the tape is reached, the tape will rewind and stop. If the beginning of the tape is reached, it will stop.

# PROGRAM TIMER RECORDING

There are two program timer recording methods, daily recording or recording on certain days of the week.

**Example 1:** To record on every Saturday from 9:00 AM to 5:00 PM (17:00), in 24-hour mode (recording speed).

- Follow the **Before starting** steps, under “NORMAL RECORDING”.
- ❶ Press the **MENU** button until the (TIMER SET) menu is displayed.
  - “SUN” (Sunday) will be flashing.

<TIMER SET>			
WEEK	START	STOP	SPD
SUN	--:--	--:--	--- N
MON	--:--	--:--	--- N
TUE	--:--	--:--	--- N
WED	--:--	--:--	--- N
THU	--:--	--:--	--- N
FRI	--:--	--:--	--- N
SAT	--:--	--:--	--- N
DLY	--:--	--:--	--- N

- ❷ Press the **↓** button, until “SAT” (Saturday) is flashing.
- ❸ Press the **→** button.
  - *The recording start hour position starts flashing.*
- ❹ Press the **▼** (or **▲**) button to set the recording start hour (ex: 09), then press the **→** button.
  - *The recording start minutes position starts flashing.*
- ❺ Press the **▼** (or **▲**) button to set the recording start minutes (ex: 00), then press the **→** button.
  - *The recording stop hour position starts flashing.*
- ❻ Press the **▼** (or **▲**) button to set the recording stop hour (ex: 17), then press the **→** button.
  - *The recording stop minutes position starts flashing.*

- ❼ Press the **▼** (or **▲**) button to set the recording stop minutes (ex: 00), then press the **→** button.
  - *The “SPD” (recording speed) position will start flashing.*

**NOTE:**

- If the set stop time is earlier than or the same time as the set start time, the VCR will consider the stop time to be the following day, and “T” will be displayed next to the recording stop time.
- ❽ Press the **▼** (or **▲**) button to select the recording speed mode (ex: 24), then press the **→** button.
  - *“N” will start flashing.*
- ❾ Press the **▼** (or **▲**) button to select the desired program timer recording mode.
  - Y . . . . . recording will take place
  - N . . . . . recording will not take place

<TIMER SET>			
WEEK	START	STOP	SPD
SUN	--:--	--:--	--- N
MON	--:--	--:--	--- N
TUE	--:--	--:--	--- N
WED	--:--	--:--	--- N
THU	--:--	--:--	--- N
FRI	--:--	--:--	--- N
SAT	09:00	17:00	24 Y
DLY	--:--	--:--	--- N

- *Repeat steps ❷ to ❾ to program timer recordings for other days of the week.*
- ❿ Press the **PAUSE/SEARCH** button to save the settings.
- ⓫ Press the **TIMER** button.
  - *The timer recording indicator “□” will light on the digital display, the VCR is now in timer recording stand-by mode.*

**NOTES:**

- To modify, cancel or stop timer recording, press the **TIMER** button to cancel the timer recording mode.
- To record everyday at the same time, at step ❷ select the “DLY” line.

## PROGRAM TIMER RECORDING

A timer recording of more than 24 hours can only be set on the 7th (SAT) and 8th (DLY) lines of the (TIMER SET) menu.

**Example 2:** To record every week from Saturday at 9:00 PM (21:00) to Monday at 7:00 AM, in 40-hour mode (recording speed).

- Follow the **Before starting** steps, under "NORMAL RECORDING".
- ❶ Press the **MENU** button until the (TIMER SET) menu is displayed.
  - "SUN" (Sunday) will be flashing.
- ❷ Press the ↓ button, until "SAT" is flashing.
- ❸ Press the ▼ (or ▲) button to set the desired start day of the week (ex: SAT), then press the → button.
  - *The recording start hour position starts flashing.*
- ❹ Press the ▼ (or ▲) button to set the recording start hour (ex: 21), then press the → button.
  - *The recording start minutes position starts flashing.*
- ❺ Press the ▼ (or ▲) button to set the recording start minutes (ex: 00), then press the → button.
  - *The recording stop hour position starts flashing.*
- ❻ Press the ▼ (or ▲) button to set "\*\*" for the recording stop hour.
  - *The rest of the line settings will change to "\*\*: \*\* \*\*\* \*", the day of the next line will change to the next day and the start time will change to "\*\*: \*\*" automatically.*
- ❼ Press the → button.
  - *The day of the week of the 8th line is flashing.*

- ❸ Press the ▼ (or ▲) button to set the desired stop day of the week (ex: MON), then press the → button.
  - *The recording stop hour position starts flashing.*
- ❾ Press the ▼ (or ▲) button to set the recording stop hour (ex: 07), then press the → button.
  - *The recording stop minutes position starts flashing.*
- ❿ Press the ▼ (or ▲) button to set the recording stop minutes (ex: 00), then press the → button.
  - *The "SPD" (recording speed) position will start flashing.*
- ⓫ Press the ▼ (or ▲) button to select the recording speed mode (ex: 40), then press the → button.
  - *"N" will start flashing.*
- ⓬ Press the ▼ (or ▲) button to select "Y".

<TIMER SET>			
WEEK	START	STOP	SPD
SUN	--:--	--:--	--- N
MON	--:--	--:--	--- N
TUE	--:--	--:--	--- N
WED	--:--	--:--	--- N
THU	--:--	--:--	--- N
FRI	--:--	--:--	--- N
SAT	21:00	**:**	*** *
MON	**:**	07:00	40 Y

- ⓭ Follow steps ❿ and ⓫ under "PROGRAM TIMER RECORDING" on page 27.

# PROGRAM TIMER RECORDING

## Setting the Holidays

By setting the holidays, timer recording will be conducted on those days, as set for Sundays.

- 1 Press the **MENU** button until the (HOLIDAY SET) menu is displayed.

<HOLIDAY SET>		
1	----	11 ----
2	----	12 ----
3	----	13 ----
4	----	14 ----
5	----	15 ----
6	----	16 ----
7	----	17 ----
8	----	18 ----
9	----	19 ----
10	----	20 ----

- 2 Press the ▼ (or ▲) button to set the month of the holiday, then press the → button.
- 3 Press the ▼ (or ▲) button to set the day of the holiday.
- 4 Press the → (or ↓) button until the next line to set start flashing.
  - o Repeat steps 2 to 4 to set up to 20 holidays.
- 5 Press the **PAUSE/SEARCH** button to save the settings.

### NOTE:

- If setting holidays, be sure that a timer recording is set for Sunday. If not, this function will not operate.
- If a timer recording for Sundays is entered, the holidays timer recording will not function if the program timer recording mode is set to "N".
- To erase a setting, follow the same procedure as above, but at step 2 and 3, enter "--" instead of a setting.

## Changing a Program Timer Recording

- 1 Press the **MENU** button until the (TIMER SET) menu is displayed.
- 2 Press the → (or ↓) button until the setting to correct is flashing.
- 3 Press the ▼ (or ▲) button to correct the setting.
- 4 Press the **PAUSE/SEARCH** button to save the settings.
- 5 Press the **TIMER** button.

## To Cancel a Program Timer Recording

- 1 Press the **MENU** button until the (TIMER SET) menu is displayed.
- 2 Press the → (or ↓) button until the "Y" corresponding to the timer recording to cancel is flashing.
- 3 Press the ▼ (or ▲) button to select "N".
- 4 Press the **PAUSE/SEARCH** button to save the settings.
- 5 Press the **TIMER** button.

## To Cancel all Program Timer Recordings

- 1 Press the **MENU** button until the (TIMER SET) menu is displayed.
- 2 Press the **MENU RESET** button.
  - o All programmed timer recordings are erased.
- 3 Press the **PAUSE/SEARCH** button, the normal screen is displayed.

## PROGRAM TIMER RECORDING

### NOTES:

- During timer recording or timer recording stand-by, all the buttons on the VCR, except the **TIMER** button and the buttons to set/cancel the security lock (see page 35), are disabled.
- If the power fails, the recording will be interrupted. When the power is restored, the recording will resume if the stop time has not yet been reached, and "P" will be displayed on the digital display. The VCR internal battery is completely recharged after the VCR has been connected to a live outlet for 48 hours, and it will maintain all the VCR settings memory for up to 30 days.
- Set the timer recordings so that the recording times do not overlap. If they do, the one with the earliest recording start time will have priority. (See chart below.)

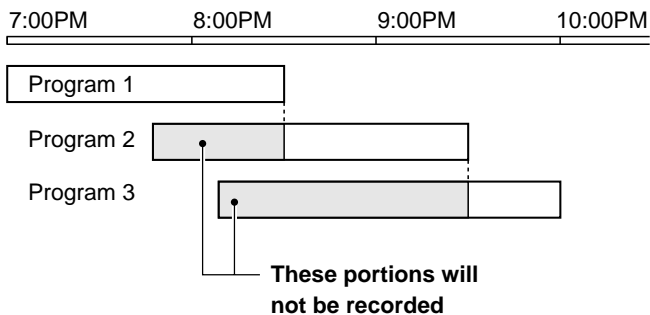

- To set two or more timer recordings for a same day of the week, press the → (or ↓) button, until the day of the week for the second recording is flashing, then press the ▼ (or ▲) button, to set the desired day of the week.
- If no timer recording is set or a cassette without erasure-prevention tab is loaded, when the **TIMER** button is pressed the timer recording indicator "□" will start flashing and a buzzer will be heard.
- If "OFF" is displayed on the digital display, timer recording is not possible in order to prevent the recorded tape to be recorded over.

# SERIES RECORDING

Using 2 VCRs or more, the series recording function lets you switch recording from one unit to the next (only with VCRs of the same model as this one).

## Series Recording Setup

- Connect 2 VCRs or more as illustrated below.
- Select the "TAPE" setting in the (SET UP 3) menu according to the type of the tape used.
- ❶ Press the **REC/PLAY SPEED CHANGE** button to set the recording speed mode.
- ❷ Set the following items as indicated.

Item	VCR No.1	VCR No.2 and on
Cassette tape	Loaded	Loaded
Operation mode	Stop	Stop
"TAPE END MODE" (in (SET UP 3) menu)	REW, STOP or EJECT	REW, STOP or EJECT
"SERIES REC IN" (in (SET UP 3) menu)	Y (YES)	Y (YES)
"OUTPUT" (in (SET UP 5) menu)	SERIES	SERIES
Security lock	Canceled	Set

- ❸ Press the **REC** button on VCR No.1.
  - Recording will start in series recording mode.
- ❹ Set the security lock on VCR No.1.

The SERIES OUT signal will be presence either at the point when the counter reading is 7:57:00 or when VCR No. 1 reaches the end of the tape, whichever is first. The signal will stop 70 seconds after the tape end point of VCR No. 1.

When this signal is received by VCR No. 2, it will start recording. During the period when the SERIES OUT signal is being received by VCR No. 2, if the **STOP** button of VCR No. 2 is accidentally pressed, VCR No. 2 will go into the stop mode for an instant and then return to the record mode.

To prevent this from occurring, the security lock of VCR No. 2 should be set to the on condition.

If TAPE END MODE is set to "REW", when the end of the tape is reached "OFF" is displayed, the tape is rewound then stop.

## NOTES:

- If the counter reading on VCR No.1 is 7:57:00 or more, when the **REC** button is pressed (step ❸), the recording will start on VCR No.2.
- If in the (SET UP 3) menu "SERIES REC IN" is set to "N" or in the (SET UP 5) menu "OUTPUT" is set to "NON REC", series recording will not be possible.
- Even if "OFF" is displayed, series recording will be conducted if there is an input at the **SERIES IN** terminal.

## Series recording connections

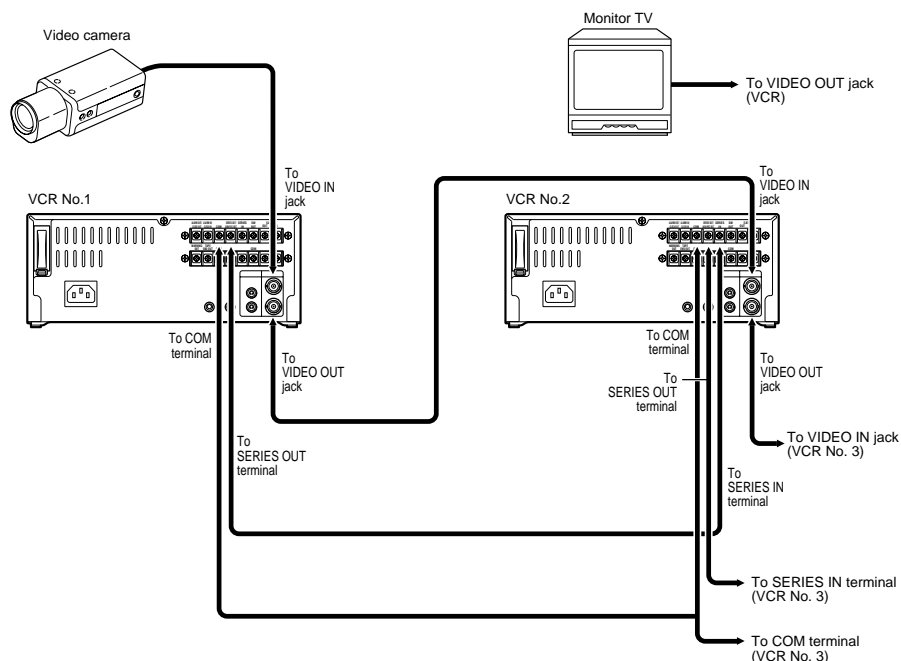



# SERIES RECORDING

## Continuous Loop Recording Setup

A minimum of 2 units are required for continuous loop recording.

Example with 2 VCRs.

Under loop recording when the recording finishes on the first unit, the new recording will start on the second unit. When the recording finishes on the second unit, recording will start on the first unit.

- 1 The **SERIES OUT/CLOCK OUT** terminal of VCR No.2 and the **SERIES IN** terminal No.1 should be connected (See diagram).
- 2 Set the following items as indicated.

Item	VCR No.1	VCR No.2
Cassette tape	Loaded	Loaded
Operation mode	Stop	Stop
"TAPE END MODE" (in (SET UP 3) menu)	REW	REW
"SERIES REC IN" (in (SET UP 3) menu)	Y (YES)	Y (YES)
"OUTPUT" (in (SET UP 5) menu)	SERIES	SERIES
Security lock	Canceled	Set

- 3 Press the **REC** button on VCR No.1.
  - o *Recording will start in series recording mode.*
- 4 Set the security lock on VCR No.1.

## Loop recording connection (example with 2 VCRs)

## NOTES:

- To avoid recording problems, the "TAPE END MODE" in (SET UP 3) menu should be set to "REW" for both units.
- In loop recording mode, the tape will be re-recorded over. If you need to keep the recorded information, please eject the tape after recording is complete and insert a new tape.



# NORMAL PLAYBACK

## Normal Playback

- ❶ Turn on the power to the VCR and TV monitor.
- ❷ Load the video cassette tape.
- ❸ Press the **REC/PLAY SPEED CHANGE** button to select the playback speed mode.
  - *The selected playback speed mode is displayed on the digital display.*

### NOTE:

- A slow motion effect or accelerated playback effect can be achieved by using a slower or faster playback speed than the speed used for recording.
- ❹ Press the **PLAY** button.
    - *Playback starts.*
    - *If necessary, adjust the tracking to eliminate the noise from the picture.*
    - *If the image is unstable (rolling vertically), adjust the vertical lock control to correct.*
  - ❺ To stop playback, press the **STOP** button.
    - *To advance or rewind the tape, press the **FF** or **REW** button.*

### NOTES:

- If a tape recorded in SP mode on a standard VCR is loaded, playback will be done in 2-hour mode.
- A tape recorded on a real time video recorder produced by another manufacturer may not play back with the same degree of clarity on this unit.
- When used with a multiplexer in 24- or 40-hour mode playback (or when "TAPE" in (SET UP 5) menu is set to "T-120", in 18- or 30-hour mode playback), the image may roll vertically. In such a case, in menu (SET UP 3) set "VERTICAL SYNC." to "N".

## Tracking Control

If there is noise in the image during playback,

- ❶ While looking at the playback picture, press and hold the **TRACKING/V. STILL+** button to minimize the noise.
- ❷ If it cannot be minimized, press the **TRACKING/V. STILL-** button.

## Vertical Lock Control

During still image mode,

- ❶ Press and hold the **TRACKING/V. STILL+** button to reduce the vertical rolling of the image.
- ❷ If it cannot be corrected, press the **TRACKING/V. STILL-** button.

## Audio Playback

- The playback speed has to be the same as the recording speed, for normal playback of the audio.

# SPECIAL PLAYBACK

## Picture Search (Forward and Reverse)

- ❶ Press the **FF** (or **REW**) button, during normal playback.
  - *The image can be seen while the tape is advanced (or rewound) at high speed.*
- ❷ To return to normal playback, press the **PLAY** button.

### NOTES:

- During picture search, noise (horizontal bars) will appear in the picture.
- The sound is muted.

## Still Image

- ❶ Press the **PAUSE/SEARCH** button, during normal playback.
  - *A still image can be viewed.*
- ❷ To return to normal playback, press the **PLAY** button.

### NOTES:

- If still mode continues for 5 minutes or more, the VCR will go into stop mode to avoid damaging the tape.
- If the image is unstable (rolling vertically), adjust the vertical lock control to correct.

## Field Advance

- ❶ Press the **FF** (or **REW**) button, during still image mode.
  - *The still image is advanced (or rewound) of one image (field).*
- ❷ To return to normal playback, press the **PLAY** button.

### NOTES:

- During reverse field advance, noise will appear in the picture.
- If field advance mode continues for 5 minutes or more, the VCR will go into stop mode to avoid damaging the tape.

# DAY/TIME SEARCH

## Day/Time Search

- 1 Press the **PAUSE/SEARCH** button three times during stop mode.

- "T/D SEARCH 01 00:00" will be displayed on screen.

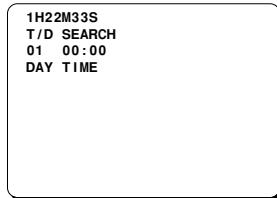

- 2 Press the ▼ (or ▲) button to set the desired day, then press the → button.
- 3 Press the ▼ (or ▲) button to set the desired hour, then press the → button.
- 4 Press the ▼ (or ▲) button to set the desired minutes.

### NOTES:

- The setting can be made in 10 minutes increments only.
  - For recordings made on other VCRs, the exact time may not be found even if the minutes are entered. For tapes recorded on older models of VCRs produced by this company (the ones without a minutes setting for the day/time search function), make sure to set the minutes to "00".
- 5 Press the **FF** (or **REW**) button.
    - The desired day/time is searched and a still image of the recording will appear on-screen.
  - 6 Press the **PLAY** button.
    - Playback will start.

### NOTES:

- If during a search the end of the tape is reached, the tape will rewind and stop. If the beginning of the tape is reached, it will stop.
- The alarm and day/time data are recorded on the tape in a similar format. If they overlap, the alarm data will have the priority. Therefore, when searching for a day/time when an alarm recording was done, the day/time search will not stop at the desired location. In such a case, use alarm scan to find the desired recording location.
- The day/time search function may not operate correctly if searching for a timer recording time or if the clock on the recording VCR has been adjusted using the **CLOCK ADJUSTMENT** function.
- If a recording on a tape extends for over a one month period, the same day may be present twice on the tape. If such a day is searched, since there is no month search setting, the desired day may not be found.

# SETTING THE SECURITY LOCK

The security lock function is designed to prevent accidental stopping of recording if the **STOP** button is pressed inadvertently.

- 1 While holding the **TRACKING/V.STILL +** button, press the **REC/PLAY SPEED CHANGE** button.
  - "1" is displayed on the digital display.

To cancel the security lock, while holding the **TRACKING/V.STILL +** button, press the **REC/PLAY SPEED CHANGE** button, "1" will be erased from the digital display.

### NOTES:

- While the security lock is engaged all commands, except the one to cancel the security lock, are disabled.
- The security lock cannot be engaged while a menu is displayed.

# SETTING THE BUZZER

A buzzer can be set to sound during alarm recording, if during recording the tape reaches the end, if buttons are pressed or if there is a mechanical failure that causes the tape to stop or be ejected, etc.

- 1 Press the **MENU** button until the (SET UP 2) menu is displayed.

<SET UP 2>	
*DISPLAY	
DATE	Y
TIME	Y
ALARM COUNT	Y
SPEED	Y
*BUZZER	
ALARM IN	Y
TAPE END	Y
KEY IN	N
WARNING	Y

- 2 Press the **↓** button, until the desired item for which the buzzer function will be set is flashing.
- 3 Press the **▼** (or **▲**) button to set “Y” for the functions described below.
  - ALARM IN . . . The buzzer will be heard during alarm recording.
  - TAPE END . . . The buzzer will be heard when the end of the tape is reached during recording. To stop the buzzer, press the **STOP**, **EJECT**, **FF**, **REW** or **PLAY** button.

- KEY IN . . . . . The buzzer will be heard when one of the VCR buttons is pressed.
- WARNING . . . The buzzer will be heard if the heads are dirty and recording quality deteriorate, or if the tape stops or is ejected due to a problem with the internal mechanism. To stop the buzzer, press the **STOP** button.

- 4 Press the **PAUSE/SEARCH** button to save the setting.

## NOTES:

- If “N” is set, the buzzer will not be heard.
- During timer recording mode, security lock engaged mode and alarm recording mode, the buzzer will not be heard when a button related to one of these modes is pressed, even if “Y” is set for the “KEY IN” item.

# CLOCK ADJUSTMENT

When using 2 or more VCRs of this same model, the clock on the second VCR and on, can be synchronized with the clock on the first VCR, using the **CLOCK ADJUSTMENT** function.

- To use **CLOCK ADJUSTMENT** function, “INPUT OUTPUT” in the (SET UP 5) menu must be set to “CLOCK SET”.
- 1 Connect the **ALARM OUT/CLOCK OUT** terminal on VCR 1 to the **ALARM IN/CLOCK IN** terminal on VCR 2.
  - 2 Repeat the procedure for all the other VCRs, connecting the **ALARM OUT/CLOCK OUT** terminal on VCR 2 to the **ALARM IN/CLOCK IN** terminal on VCR 3, and so on.
  - 3 Press the **MENU** button until the (SET UP 3) menu is displayed.
  - 4 Press the **↓** button, until the “EXT TIME ADJ.” setting is flashing.
  - 5 Press the **▼** (or **▲**) button to set the hour at which the adjustment will be conducted.

## NOTES:

- Be sure to set the same time on all the VCRs.
- The clock adjustment cannot be set to “00:00”.

## Example

<SET UP 3>	
*ALARM MODE	Y1
*ALARM SPEED	8H
*ALARM DURATION	20S
*VERTICAL SYNC	Y
*EXT TIME ADJ.	03:00
*TAPE IN MODE	STOP
*TAPE END MODE	REW
*TAPE END OUT	-3M
*CLOG DETECT.	Y
*SERIES REC IN	N

- 6 Press the **PAUSE/SEARCH** button to save the setting.
  - The setting procedure on the first VCR is now completed.
- 7 Repeat the procedure for all the other VCRs, setting “EXT TIME ADJ.” (to the same time as set on the first VCR).

## NOTES:

- Connect the **COM** terminal on all VCRs used.
- This function will not operate on the day the daylight saving/standard time is changed.

# SETTING THE CASSETTE EJECT MODE

## Cassette Eject Setup

When using 2 VCRs or more, the cassette tape of all the VCRs or some of the VCRs can be ejected, if the **EJECT** terminals on the VCRs are connected as indicated.

- 1 Press the **MENU** button until the (SET UP 4) menu is displayed.

<SET UP 4>	
*SW OUT	
FIELD	01
TIMING	FIELD
8H	Y
*THREAD CHECK	Y
*VIDEO LOSS	N
*REC SPEED	N
*EJECT SET	
EJECT MODE	EJECT1
OPERATION	SLAVE

- 2 Press the ↓ button, until the “EJECT MODE” setting is flashing.
- 3 Press the ▼ (or ▲) button to set the desired cassette eject mode.  
EJECT1 . . . . . The cassette is ejected only if the VCR is not in recording mode.  
EJECT2 . . . . . The cassette is ejected only if the VCR is in stop mode.
- 4 Press the ↓ button, until the “OPERATION” setting is flashing.
- 5 Press the ▼ (or ▲) button to set the desired operation.  
SLAVE . . . . . When the **EJECT** button is pressed, the cassette tape of that VCR only will be ejected.  
MASTER . . . . . When the **EJECT** button is pressed, the cassette tape of that VCR and of any VCR connected after it will be ejected.
- 6 Press the **PAUSE/SEARCH** button to save the settings.

### NOTE:

- The **EJECT** button will not be operative during recording mode.

## EJECT terminal connection

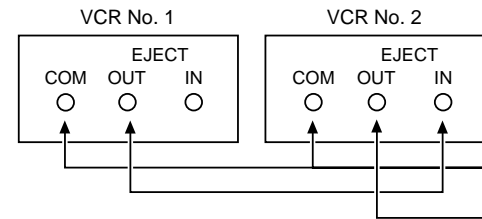

### EJECT IN terminal

- Depending on the (SET UP 4) menu “EJECT MODE” setting (see “Cassette Eject Setup”), the cassette loaded in the VCR is ejected when there is an input at this terminal.

### EJECT OUT terminal

- When the **EJECT** button is pressed (if the VCR is setup as “MASTER”, see step 5 under “Cassette Eject Setup”) or when there is an input (trigger) at the **EJECT IN** terminal, a signal is output at this terminal, even if the security lock is set or if a cassette is not loaded.

# SETTINGS FOR RS485 TERMINALS USE

If the VCR is going to be controlled through a connection to the RS485 terminals, be sure to first make the settings below.

## NOTES:

- Can only be used with the optional RS-485 board.
  - When using the optional RS-485 board, the VCR can be controlled from a special controller.
- 1 Press the **MENU** button until the (SET UP 6) menu is displayed.
    - The "ADDRESS" setting is flashing.

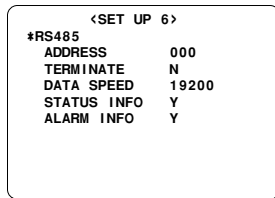

- 2 Press the ▼ (or ▲) button to set the VCR address, then press the ↓ button.

## NOTES:

- The address can be set between 000 and 127.
- Keep the button pressed and the setting will change rapidly.

- 3 Press the ▼ (or ▲) button to set the termination, then press the ↓ button.

N . . . . . Not terminated  
 Y . . . . . Terminated

- 4 Press the ▼ (or ▲) button to set the data transfer speed, then press the ↓ button.

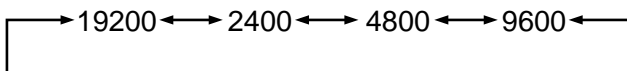

- 5 Press the ▼ (or ▲) button to set the "STATUS INFO" setting, then press the ↓ button.

Y . . . . . The VCR status information (state information and warning state) are output at the RS485 terminal.

N . . . . . The state information is not output at the RS485 terminal. However, the warning state is output at the RS485 terminal.

- 6 Press the ▼ (or ▲) button to set the "ALARM INFO" setting.

Y . . . . . The VCR alarm information (alarm recording start and stop) and video loss information are output at the RS485 terminal.

N . . . . . The VCR alarm information (alarm recording start and stop) and video loss information are not output at the RS485 terminal.

## NOTE:

- The video loss information output (sent) will depend on the settings for "VIDEO LOSS" in the (SET UP 4) menu.

- 7 Press the **PAUSE/SEARCH** button to save the settings.

# CHECKING POWER FAILURE, FAILURE DUE TO CONDENSATION AND USAGE DURATION

- 1 Press the **MENU** button until the (POWER FAILURE), (DEW) and (USED TIME) menu is displayed.

(POWER FAILURE) . . . The number of power failures, and the date and time of the most recent power failure and recovery are displayed.

(DEW) . . . . . The number of failures due to condensation, and the date and time of the most recent failure and recovery are displayed.

(USED TIME) . . . . . The video heads usage duration and the power on duration are displayed.

## Example

```
<POWER FAILURE>
002 FAILURE 12-25 07:15
RECOVERY 12-25 07:30

<DEW>
001 FAILURE 12-25 11:00
RECOVERY 12-25 12:00

<USED TIME>
VIDEO 00003H
POWER 00007H
```

- 2 Press the **PAUSE/SEARCH** button, the normal screen is displayed.

**NOTE:** If the **MENU RESET** button is pressed while the (POWER FAILURE) and (DEW) menu is displayed, the data is erased. The (USED TIME) data cannot be reset. "P" will be erased from the digital display.



# OUTPUT TERMINALS

## TAPE END OUT Terminal

- During recording, when the end of the tape is reached or when the tape counter reading indicates 7 hours 57 minutes or more, the output becomes 0V (Low).
- To reset the output, press the **STOP** or **EJECT** button.
- During autorepeat recording, when the end of the tape is reached, the output becomes 0V (Low) for about 2 seconds only.

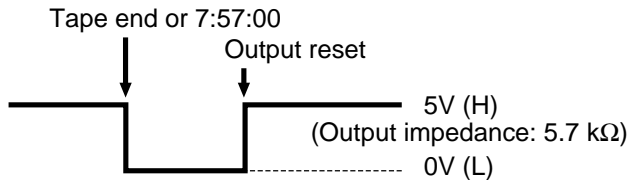

## TAPE END OUT Terminal Output Setting

- 1 Press the **MENU** button until the (SET UP 3) menu is displayed.

<SET UP 3>	
*ALARM MODE	Y1
*ALARM SPEED	8H
*ALARM DURATION	20S
*VERTICAL SYNC	Y
*EXT TIME ADJ.	01:00
*TAPE IN MODE	STOP
*TAPE END MODE	REW
*TAPE END OUT	-3M
*CLOG DETECT.	Y
*SERIES REC IN	N

- 2 Press the **↓** button until the "TAPE END OUT" setting is flashing.
- 3 Press the **▼** (or **▲**) button, to select the desired output mode.
  - 3M . . . . . The output becomes 0 V (Low) when the tape counter reaches "7:57:00" and/or when the tape reaches the end.
  - END . . . . . The output becomes 0 V (Low) when the tape reaches the end.
- 4 Press the **PAUSE/SEARCH** button to save the setting.

## SW OUT Terminal

When recording, a pulse signal is output at the **SW OUT** terminal.  
 This terminal is usually connected to the switch input (SW IN) of devices like a camera switcher unit, or a quad compressor.

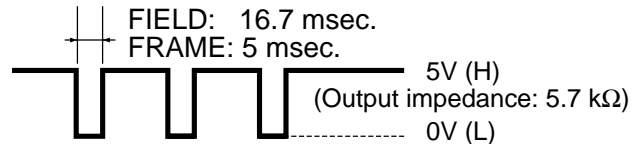

## SW OUT Terminal Output Setting

- 1 Press the **MENU** button until the (SET UP 4) menu is displayed.

<SET UP 4>	
*SW OUT	
TIMING	FIELD
FIELD	01
8H	Y
*THREAD CHECK	Y
*VIDEO LOSS	N
*REC SPEED	N
*EJECT SET	
EJECT MODE	EJECT1
OPERATION	SLAVE

- 2 Press the **▼** (or **▲**) button to set "FIELD" or "FRAME", then press the **↓** button.
  - FIELD . . . . . 1 pulse is output after each set number of fields.
  - FRAME . . . . . 1 pulse is output after each set number of frames.
- 3 Press the **▼** (or **▲**) button to set the desired pulse signal interval, then press the **↓** button.
  - If "TIMING" is set to FRAME (see step 4), "FRAME" will be indicated instead of "FIELD".
  - Available settings are:
    - FIELD . . . . . 01, 02, 03, 04, 05, 10, 30 or 60 field
    - FRAME . . . . . 01, 02, 03, 04, 05, 10, 30 or 60 frame
- 4 Press the **▼** (or **▲**) button to set the desired "8H (or 6H)" mode.
  - If the "TAPE" in the (SET UP 5) menu is set to "T-120", "6H" will be indicated instead of "8H".
    - Y . . . . . When recording in 8-hour (or 6-hour) mode, a pulse signal is output.
    - N . . . . . When recording in 8-hour (or 6-hour) mode, a pulse signal is not output.
- 5 Press the **PAUSE/SEARCH** button to save the settings.

# OUTPUT TERMINALS

## SERIES OUT/NON REC OUT terminal setting

The output at the **SERIES OUT/NON REC OUT** terminal can be set.

- 1 Press the **MENU** button until the (SET UP 5) menu is displayed.

### NOTE:

- If "OUTPUT" is set to "NON REC", the "NON REC OUT" line will be displayed under the "OUTPUT" line.

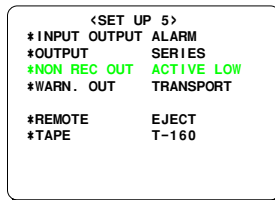

- 2 Press the ↓ button, until the "OUTPUT" setting is flashing.

- 3 Press the ▼ (or ▲) button, to select the desired output mode.

**SERIES . . . . .** The **SERIES OUT/NON REC OUT** terminal will be set to **SERIES OUT**.  
If during series recording, the counter reading reaches 7:57:00 or the tape reaches the end, a LOW signal (0 V) is output. The LOW (0 V) signal is output for about 70 seconds after the end of the tape is reached.

**NON REC . . . . .** The **SERIES OUT/NON REC OUT** terminal will be set to **NON REC OUT**.

If "OUTPUT" is set to "NON REC", please continue with step 4.

- 4 Press the ↓ button.
- 5 Press the ▼ (or ▲) button to select the desired output.

**ACTIVE LOW . . . . .** Normally DC 5V are output between the **SERIES OUT/NON REC OUT** and the **COM** terminals. If during recording the VCR enters a mode other than recording (i.e. recording pause, stop mode, etc.), the output become 0 V (Low). If recording is resumed, then the output become 5 V (High).

**ACTIVE HIGH . . . . .** Normally 0V are output between the **SERIES OUT/NON REC OUT** and the **COM** terminals. If during recording the VCR enters a mode other than recording (i.e. recording pause, stop mode, etc.), the output become 5 V (High). If recording is resumed, then the output become 0 V (Low).

### NOTES:

- If "NON REC OUT" is set to "ACTIVE HIGH", a throwaway pulse will be output from the **SERIES OUT/NON REC OUT** terminal when power is restored after an outage, when the power is turned on or when the **ALL RESET** button is pressed. This will continue until the microprocessor starts operating. If this output terminal is connected to some other device, the device should be set or adjusted so that it is not affected by the throwaway pulse. If set to "ACTIVE LOW", this kind of pulse is not output, and so it is recommended that you use the "ACTIVE LOW" setting.
- If in the (SET UP 2) menu, in the "BUZZER" section, "WARNING" is set to "Y", a buzzer will be heard while the VCR is in non recording mode. The buzzer will stop if the **STOP** button is pressed (the output signal will remain).

- 6 Press the **PAUSE/SEARCH** button to save the setting.

## ALARM IN/CLOCK IN and ALARM OUT/CLOCK OUT terminal setting

- 1 Press the **MENU** button until the (SET UP 5) menu is displayed.

◦ The "INPUT OUTPUT" setting is flashing.

- 2 Press the ▼ (or ▲) button to select desired input/output mode.

**ALARM . . . . .** The **ALARM IN/CLOCK IN** terminal is set to **ALARM IN** and the **ALARM OUT/CLOCK OUT** terminal is set to **ALARM OUT**.

**CLOCK SET. . . . .** The **ALARM IN/CLOCK IN** terminal is set to **CLOCK IN** and the **ALARM OUT/CLOCK OUT** terminal is set to **CLOCK OUT**.

- 3 Press the **PAUSE/SEARCH** button to save the setting.

# OUTPUT TERMINALS

## REMOTE Jack

You can use a VA-RMN01 Remote Control Unit (sold separately) to control remotely the VCR.

### NOTE:

- The functions not available on the VCR will not operate.

Remote control of the VCR is possible by connecting a remote controller with a circuit such as indicated below, to the **REMOTE** jack.

### NOTES:

- Use a 3.5 mm mini-jack type plug.
- The connection should be done using a shielded cable no more than 5 meters long.
- The functions not available on the VCR will not operate.

Remote control circuit

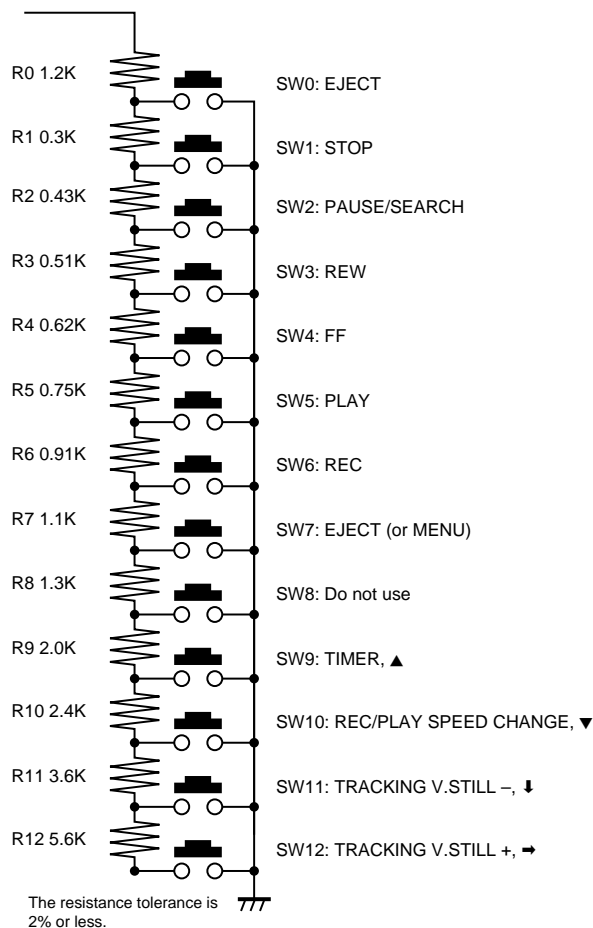

## Remote control setting

The remote control switch 7 can be set to either eject the tape or access the menus.

- 1 Press the **MENU** button until the (SET UP 5) menu is displayed.

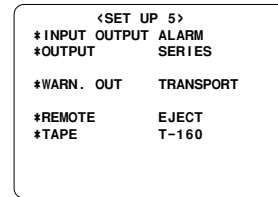

- 2 Press the ↓ button, until the “REMOTE” setting is flashing.
- 3 Press the ▼ (or ▲) button to select the desired switch mode.
  - EJECT . . . . . Switch 7 will eject the tape.
  - MENU. . . . . Switch 7 will display the menu.
- 4 Press the **PAUSE/SEARCH** button to save the setting.

## COM Terminal

- Common GND (ground) terminal when connecting other terminals to external devices.

# OUTPUT TERMINALS

## WARNING OUT Terminal

- If the tape stops or other problem, the output becomes 0V (Low).
- To reset the output, press the **STOP** or **ALL RESET** button or unplug the power cord then plug it back in.

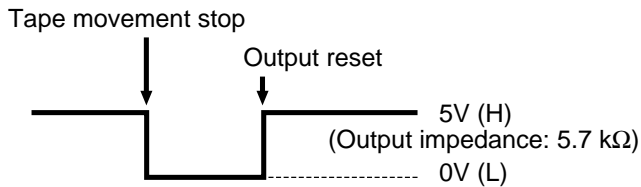

## WARNING OUT Terminal Output Setting

- 1 Press the **MENU** button until the (SET UP 5) menu is displayed.

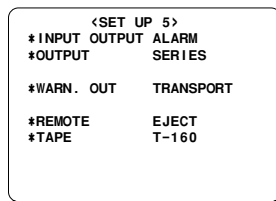

- 2 Press the ↓ button, until the “WARN. OUT” setting is flashing.
- 3 Press the ▼ (or ▲) button, to select the desired output mode.

TRANSPORT. The output becomes 0V (Low) when the tape stops or other problem with the internal mechanism.

V. LOSS . . . . . The output becomes 0V (Low) when there is no video signal (Please refer to page 21, “Action to Take when the Video Signal Deteriorates.”).

T OR V . . . . . The output become 0V (Low) when the tape stops or other problem with the internal mechanism, or when there is no video signal (Please refer to page 21, “Action to Take when the Video Signal Deteriorates.”).

### NOTE:

- If in the (SET UP 4) menu “VIDEO LOSS” is set to “N”, the “WARN. OUT” setting will be preset to “TRANSPORT” and cannot be changed.

- 4 Press the **PAUSE/SEARCH** button to save the setting.

# MAINTENANCE

## Daily Inspection

The following daily inspections are recommended in order to assure long-term and trouble-free operation of the unit.

The daily inspections are particularly important if using autorepeat recording.

## Inspection Procedure

- ❶ Turn on the power to the VCR, camera, TV monitor and other connected devices.
- ❷ Check that the image received on the TV monitor is correct.
- ❸ Check that the on-screen display of the date and time is correct.
- ❹ To check the recording condition of the previous day, rewind the recorded tape a few seconds.
- ❺ Press the **PLAY** button and check that the playback image is correct.
- ❻ Check that the recorded date and time are correct.

## NOTES:

- If the security lock is engaged, it has to be released before proceeding to the inspection.
- If any problem is discovered during the inspection, unplug the power cord then consult your dealer.

## Periodic Inspection

Periodic inspection and maintenance should be referred to your dealer.

If there is noise in the playback picture, and it cannot be corrected using the tracking control, it may indicate that the video heads need cleaning.

The video heads should be inspected every 1,000 hours of use to determine if they need to be replaced.

The video heads usage can be checked using the (USED TIME) menu.

## Cabinet Cleaning

Clean the outside of the cabinet with a clean, soft cloth, moistened with lukewarm water and wrung dry.

DO NOT USE SOLVENTS OR OTHER TYPES OF CLEANERS. THESE CHEMICALS CAN CRACK OR DISCOLOR THE CABINET.

## About the Backup Battery

The date and time settings are maintained for up to 30 days by a rechargeable lithium battery that is fully charged after the VCR has been connected to a power source for 48 hours or more.

Depending on the battery usage it may become necessary to change it. For replacement and disposal of the old battery, please contact your dealer.

After the battery has been replaced, press the **ALL RESET** button, then enter all the time, date, etc. settings as required.

# MAINTENANCE

## Maintaining and Checking The Mechanism

To maintain the VCR functions and features working properly, and to avoid damages or dirt on the tape, it is recommended to follow the maintenance points and periodicity indicated below.

For detailed information, please contact your dealer.

### Maintenance Table

○ : Cleaning    ⊙ : Confirmation    △ : Lubrication    □ : Change

	PARTS	2000H	4000H	6000H	8000H	NOTES
Tape Path System	ASSY, BRAKE BAND	⊙	□	⊙	□	
	ASSY, LEVER BT (tape guide)	○	○	○	○	
	FULL ERASE HEAD	○	○	○	□	
	ASSY, ROLLER CLEANER	⊙	□	⊙	□	
	ASSY, GUIDE ROLLER	○	○	○	○	
	ASSY, MOUNTING INCLNE S	○	○	○	□	
	ASSY, MOUNTING INCLNE T	○	○	○	□	
	ACE HEAD	○	○	○	□	
	ASSY, LEVER PINCH ROLLER	○	□	○	□	
	MOUNTING, LIFT PINCH				□	
	CAM, LIFT PINCH				□	
	GEAR, CAM PINCH				□	
	ASSY, EARTH CYL		□		□	
	COMPL, CYLINDER	○	○(□)	○	○(□)	
ASSY, CYLINDER UPPER	○(□)	○(□)	○(□)	○(□)		
Reel Drive System	ASSY, REEL SUPPLY	○△	○△	○△	○△	
	ASSY, REEL TAKEUP	○△	○△	○△	○△	
	GEAR, REEL S	△	△	△	△	
	GEAR, REEL T	△	△	△	△	
	PULLEY, REEL	△	△	△	△	
	SPECIAL, WASHER 2.4 X 6 X 0.25		⊙		⊙	
	COMPL, MOUNTING CLUTCH	△	□	△	□	
	BELT, REEL	⊙	□		□	
	MOTOR, CAPSTAN	○	⊙(□)	⊙(□)	□	
	ASSY, GEAR FRICTION	△	△□	△	△□	
Brake	ASSY, BRAKE S	⊙	⊙	⊙	⊙	
	ASSY, BRAKE T	⊙	⊙	⊙	⊙	
	ASSY, BRAKE CAPSTAN	⊙	⊙	⊙	⊙	
	ASSY, BRAKE SOFT T		⊙		□	
Loading Drive System	ASSY, LOADING MOTOR		⊙		□	
	DAMPER				□	
	COMPL, GEAR WORM		⊙		□	
	CAM, MAIN				□	
	SPECIAL WASHER 3.6 X 0.5		⊙		□	
	GEAR, WHEEL 1				□	
	GEAR, WHEEL 2		⊙		□	
	MODE SWITCH		⊙		□	
	SLIDE, CRECENT		⊙		□	
	GEAR, LOAD S		⊙		□	
	GEAR, RACK FRONT		⊙		□	
	GEAR, RACK START		⊙		□	
GEAR, PINON		⊙		□		
Performance Check	BACK TENSION TORQUE	⊙	⊙	⊙	⊙	PB BACK TENSION TORQUE 25~50g.cm
	FWD, REW TORQUE	⊙	⊙	⊙	⊙	FWD, REW TORQUE ≥ 600g.cm
	PLAY TORQUE	⊙	⊙	⊙	⊙	PLAY 55 ~ 110g.cm
	REV TORQUE	⊙	⊙	⊙	⊙	REV 100 ~ 210g.cm

### NOTES:

1. This table shows the maintenance for up to 8000 hours. After this, repeat from the start of the table.
2. For places with symbols such as ⊙ (□) and ○ (□), carry out checking and cleaning, and replace if necessary.
3. This periodic maintenance check table changes considerably according to the using conditions and environment.
4. Refer to (USED TIME) menu for the length of time the unit has been used.
5. As life may be shortened if foreign particles and dusts remain accumulated on the tape guides and rotating and contacting portions, clean if dirty.
6. Dusts and other foreign particles on the tape guides may also shorten the tape life and lower picture quality, therefore clean thoroughly.

# TROUBLESHOOTING GUIDE

If the unit does not operate normally when you follow the instructions indicated in the manual, please refer to the table below.

SYMPTOM	POSSIBLE CAUSE	CORRECTIVE ACTION
No power	The power cord is not connected	Connect the power cord
No image displayed on the monitor TV	The connections are not correct	Check that all connections are correct
	The power to the camera and/or monitor TV is not turned on	Turn all connected devices power on
The buttons do not respond	A cassette tape is not loaded	Load a cassette and turn the power on
	All functions are suspended due to condensation	Wait for the "ddd" indicator to go off
	Alarm recording	Wait for the alarm recording to end
	The security lock is engaged	Cancel the security lock
Recording is not possible (the tape is ejected)	The loaded cassette has no erasure-prevention tab	Load a cassette tape with erasure-prevention tab or cover the tab hole with adhesive tape
Autorepeat recording is not possible	"AL" is displayed on the digital display	Display (ALARM TIME) menu, then press the <b>MENU RESET</b> button to turn off the "AL" indicator
Timer recording is not possible	The date and time are not set correctly	Set the date and time correctly
	The unit is not set to timer recording stand-by mode	Press the <b>TIMER</b> button to display "□" on the digital display
	"N" is selected for the timer recordings	Be sure to select "Y" for the programmed timer recordings
Alarm recording is not possible	"OFF" is displayed on the digital display	Press the <b>EJECT, STOP, FF, REW</b> or <b>PLAY</b> button to turn the indicator off
Noise in the playback picture	The video heads need cleaning	Clean the video heads
The date and time are not recorded	The <b>ON SCREEN</b> switch is set to the "OFF" position	Set the <b>ON SCREEN</b> switch to the "ON" position
The cassette tape cannot be ejected	Problem with the system	Unplug the power cord then plug it back in
The cassette is ejected a few seconds after it has been inserted	The tape is not threaded correctly	Try inserting the cassette one more time or using a new cassette. If it is ejected again, please consult your dealer.

## After a Power Failure

If after a power failure the recording speed is reset to 8-hour mode, it is due to insufficient backup battery charge. This is not a malfunction.

## System Down

If the unit does not function at all, try the following.

- ❶ Unplug the power cord then plug it back in.
- ❷ Reset the memory. (Press the **ALL RESET** button. Under normal conditions, do not touch the **ALL RESET** button.)

### NOTE:

- The time and date will be reset, and the security lock will be cancelled.
- ❸ If the problem is not corrected after performing steps ❶ and ❷ a few times, consult your dealer.

# SPECIFICATIONS

## General Specifications

Video heads system	Dual-azimuth 4-head rotating helical scanning system: Dual azimuth 2-head for record and standard playback Dual azimuth 4-head for forward picture search, reverse picture search and still mode
Audio recording	In 8-, 24- and 40-hour modes (when using T-160 tape) In 6-, 18- and 30-hour modes (when using T-120 tape)
Tape speed	11.12 mm /sec
Specified video cassette tape	VHS 1/2 inch video cassette tape
Recording/playback time	8, 24 and 40 hours (when using T-160 tape) 6, 18 and 30 hours (when using T-120 tape)
Fast forward/rewind time	approximately 3 minutes 30 seconds (when using T-160 tape)
Television system	NTSC color TV system
RS-485 data transfer speed	19200, 9600, 4800, 2400 baud

## Video

Recording method	Luminance signal: FM recording Chrominance signal: Down-converted direct recording
Video input	1 V(p-p), BNC, 75 $\Omega$ , unbalanced
Video output	1 V(p-p), BNC, 75 $\Omega$ , unbalanced
Horizontal resolution	Black & white mode            350 line or more Color mode                        300 line or more

## Audio

Input	-8 dBs, RCA pin jack, 27 k $\Omega$ , unbalanced
Output	-8 dBs, RCA pin jack, 600 $\Omega$ , unbalanced
Microphone input	-60 dBs, 3.5 mm mini jack, 10 k $\Omega$ , unbalanced

## Connectors

Alarm input/Clock input	Low level active (0V 100msec or more)
Alarm output/Clock output	DC 5 V ( $\pm 0.5$ )/5.7 k $\Omega$ , Low at alarm or clock set in
Series input	Low level active (0V 1sec or more)
Series output/Non rec output	DC 5 V ( $\pm 0.5$ )/5.7 k $\Omega$
Switch output	DC 5 V ( $\pm 0.5$ )/5.7 k $\Omega$ , Low at switching
Eject input	Low level active (0V 100msec or more)
Eject output	DC 5 V ( $\pm 0.5$ )/5.7 k $\Omega$ , Low at eject in
Warning output	DC 5 V ( $\pm 0.5$ )/5.7 k $\Omega$ , Low at warning
Tape end output	DC 5 V ( $\pm 0.5$ )/5.7 k $\Omega$ , Low at tape end
Common	0 V (GND)
Remote control input	3.5 mm mini jack
With the optional RS-485 board	
RS485 A	Non-inverting driver output/receiver input
RS485 B	Inverting driver output/receiver input

## Other Specifications

Operating temperature range	5°C to 40°C
Operating humidity range	80% or less
Power requirements	120 V AC, 60 Hz
Power consumption	17 W
Dimensions	240 (W) x 96.5 (H) x 335 (D) mm
Weight	approximately 3.8 kg

**NOTE:** The specifications and external appearance of this unit are subject to change without notice.



# SANYO INDUSTRIAL VCR WARRANTY

## OBLIGATIONS

In order to obtain warranty service, the product must be delivered to and picked up from an Authorized Sanyo Service Center at the user's expense, unless specifically stated otherwise in this warranty. The names and addresses of Authorized Sanyo Service Centers may be obtained by calling the toll-free number listed below.

For product operation, authorized service center referral, service assistance or problem resolution, call  
**CUSTOMER INFORMATION 1-800-421-5013**  
**Weekdays 8:30 AM – 5:00 PM Pacific Time**

For accessories and/or parts, call  
**PARTS ORDER INFORMATION 1-800-726-9662**  
**Weekdays 8:30 AM – 5:00 PM Pacific Time**

THIS WARRANTY IS VALID ONLY ON SANYO PRODUCTS PURCHASED OR RENTED IN THE UNITED STATES OF AMERICA, EXCLUDING ALL U.S. TERRITORIES AND PROTECTORATES. THIS WARRANTY APPLIES ONLY TO THE ORIGINAL RETAIL PURCHASER OR END-USER. THE ORIGINAL DATED BILL OF SALE, SALES SLIP OR RENTAL AGREEMENT MUST BE SUBMITTED TO THE AUTHORIZED SANYO SERVICE CENTER AT THE TIME WARRANTY SERVICE IS REQUESTED.

Subject to the OBLIGATIONS above and EXCLUSIONS below, SANYO Fisher Company warrants this SANYO product against defects in materials and workmanship for the periods specified below. SFC will repair or replace (at its option) the product and any of its parts which fail to conform to this warranty. The warranty period commences on the date the product was first purchased or rented at retail.

LABOR	PARTS	VIDEO HEADS
1 YEAR	1 YEAR	90 DAYS

## EXCLUSIONS

This warranty does not cover (A) the adjustment of customer-operated controls as explained in the appropriate model's instruction manual, or (B) the repair of any product whose serial number has been altered, defaced or removed.

This warranty shall not apply to the cabinet or cosmetic parts, batteries or routine maintenance.

This warranty does not apply to uncrating, setup, installation, removal of the product for repair or reinstallation of the product after repair.

This warranty does not apply to repairs or replacements necessitated by any cause beyond the control of SFC including, but not limited to, any malfunction, defect or failure caused by or resulting from unauthorized service or parts, improper maintenance, operation contrary to furnished instructions, shipping or transit accidents, modification or repair by the user, abuse, misuse, neglect, accident, incorrect power line voltage, fire, flood or other Acts of God, or normal wear and tear.

The foregoing is in lieu of all other expressed warranties and SFC does not assume or authorize any party to assume for it any other obligation or liability.

SFC DISCLAIMS ALL OTHER WARRANTIES EXPRESS OR IMPLIED, WITH REGARD TO THIS PRODUCT (INCLUDING THE WARRANTIES OF MERCHANTABILITY AND FITNESS). IN NO EVENT SHALL SFC BE LIABLE FOR ANY SPECIAL, INCIDENTAL OR CONSEQUENTIAL DAMAGES ARISING FROM THE OWNERSHIP OR USE OF THIS PRODUCT OR FOR ANY DELAY IN THE PERFORMANCE OF ITS OBLIGATIONS UNDER THIS WARRANTY DUE TO CAUSES BEYOND ITS CONTROL. SFC'S LIABILITY FOR ANY AND ALL LOSSES AND DAMAGES RESULTING FROM ANY CAUSE WHATSOEVER, ARISING OUT OF OR IN CONNECTION WITH THE SALE, USE OR OWNERSHIP OF THIS PRODUCT INCLUDING WARRANTOR'S NEGLIGENCE, ALLEGED DAMAGED OR DEFECTIVE GOODS, WHETHER SUCH DEFECTS ARE DISCOVERABLE OR LATENT, SHALL IN NO EVENT EXCEED THE PURCHASE PRICE OF THE PRODUCT.

## ATTENTION

For your protection in the event of theft or loss of this product, please fill in the information below for you own personal records.

**Model No.** \_\_\_\_\_ **Serial No.** \_\_\_\_\_  
 (Located on back or bottom side of unit.)

**Date of Purchase** \_\_\_\_\_ **Purchase Price** \_\_\_\_\_

**Where Purchased** \_\_\_\_\_



---

**SANYO Electric Co., Ltd.**

1AC6P1P2364--C  
NU4QR/NA  
(0601KP-01)

Issue No. 3

Copyright SANYO, 2000 All rights reserved.

Printed in Indonesia

## Free Manuals Download Website

<http://myh66.com>

<http://usermanuals.us>

<http://www.somanuals.com>

<http://www.4manuals.cc>

<http://www.manual-lib.com>

<http://www.404manual.com>

<http://www.luxmanual.com>

<http://aubethermostatmanual.com>

Golf course search by state

<http://golfingnear.com>

Email search by domain

<http://emailbydomain.com>

Auto manuals search

<http://auto.somanuals.com>

TV manuals search

<http://tv.somanuals.com>