

SANYO

INSTRUCTION MANUAL

**SRT-4040
SRT-4040DC**

Real Time Video Cassette Recorder

English

Magnétoscope en temps réel

Français

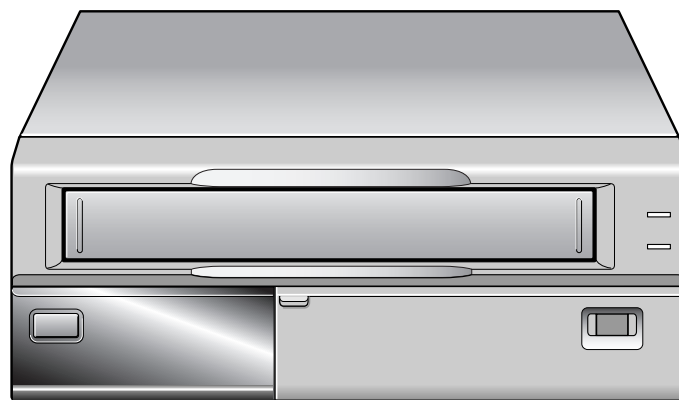

Videograbador en tiempo real

Español



Please read this manual and accompanying "IMPORTANT SAFETY INSTRUCTIONS" sheet carefully before connecting your VCR and operating it for the first time.
Be sure to read carefully and follow all the PRECAUTIONS on page 1 and 2.
Keep the manual in a safe place for future reference.

PRECAUTIONS



	CAUTION RISK OF ELECTRIC SHOCK DO NOT OPEN	
CAUTION: TO REDUCE THE RISK OF ELECTRIC SHOCK, DO NOT REMOVE COVER (OR BACK). NO USER-SERVICEABLE PARTS INSIDE. REFER SERVICING TO QUALIFIED SERVICE PERSONNEL.		

WARNING: To reduce the risk of fire or electric shock, do not expose this appliance to rain or other moisture.

CAUTION: Changes or modifications not expressly approved by the manufacturer may void the user's authority to operate this equipment.

For customers in Canada

This class B digital apparatus complies with Canadian ICES-003.

	The lightning flash with arrowhead symbol, within an equilateral triangle, is intended to alert the user to the presence of uninsulated "dangerous voltage" within the product's enclosure that may be of sufficient magnitude to constitute a risk of electric shock to persons.
	The exclamation point within an equilateral triangle is intended to alert the user to the presence of important operating and maintenance (servicing) instructions in the literature accompanying the product.

This equipment has been tested and found to comply with the limits for a Class B digital device, pursuant to part 15 of the FCC Rules. These limits are designed to provide reasonable protection against harmful interference in a residential installation. This equipment generated, uses and can radiate radio frequency energy and, if not installed and used in accordance with the instructions, may cause harmful interference to radio communications. However, there is no guarantee that interference will not occur in a particular installation. If this equipment does cause harmful interference radio or television reception, which can be determined by turning the equipment off and on, the user is encouraged to try to correct the interference by one or more of the following measures:

- Reorient or relocate the receiving antenna.
- Increase the separation between the equipment and receiver.
- Connect the equipment into an outlet on a circuit different from that to which the receiver is connected.
- Consult the dealer or an experienced radio/TV technician for help.

PRECAUTIONS

Location

For safe operation and satisfactory performance of your VCR, keep the following in mind when selecting a place for its installation:

- Shield it from direct sunlight and keep it away from sources of intense heat.
- Avoid dusty or humid places.
- Avoid places with insufficient ventilation for proper heat dissipation. Do not block the ventilation holes of the VCR. Do not place the unit on a carpet because this will block the ventilation holes.
- Install the VCR in a horizontal position only.
- Avoid locations subject to strong vibrations.
- Avoid moving the VCR between cold and hot locations (see "Moisture Condensation Problems", this page).
- Do not place the VCR directly on top of the TV, as this may cause playback or recording problems.

Avoiding Electrical Shock and Fire

- Do not handle the power cord with wet hands.
- Do not pull on the power cord when disconnecting it from an AC wall outlet. Grasp it by the plug.
- If any liquid is spilled on the VCR, unplug the power cord immediately and have the unit inspected at a factory-authorized service center.
- Do not place anything directly on top of this VCR.

Moisture Condensation Problems

Cause:

When the VCR is first installed, moved from a cold area to a warm area or placed in a location with high humidity, dew (moisture) may form in the unit. The Dew indicator (d d d d) blinks. If you operate the VCR with dew inside, damage may result.

Prevention:

- ❶ Do not operate the VCR for approximately 2 hours.

When the VCR reaches room temperature, the Dew indicator (d d d d) will turn off and the VCR will be ready for operation.

CONTENTS

PRECAUTIONS	1
FEATURES	3
ACCESSORY (SRT-4040 only)	3
LOCATIONS OF CONTROLS AND INDICATORS	4
CONNECTIONS	9
ON-SCREEN MENU	10
SETTING THE LANGUAGE AND CLOCK	12
SUPERIMPOSE DISPLAY	14
VIDEO CASSETTE TAPES	15
TAPE MANAGEMENT	17
NORMAL RECORDING	20
AUTOREPEAT RECORDING	24
ALARM RECORDING	25
PROGRAM TIMER RECORDING	28
RECORDING USING AN EXTERNAL TIMER INPUT .	32
SERIES RECORDING	33
SINGLE IMAGE RECORDING	34
NORMAL PLAYBACK	35
SPECIAL PLAYBACK	36
DAY/TIME SEARCH	37
SECURITY LOCK	37
CLOCK ADJUSTMENT	38
SELECTING INPUT AND OUTPUT TERMINALS	38
SETTING THE CASSETTE EJECT MODE	39
SYNCHRONIZATION CONTROL	40
SETTING FOR RS-485 USE	42
CHECKING POWER FAILURE, FAILURE DUE TO CONDENSATION AND USAGE DURATION	43
OUTPUT TERMINALS	44
MAINTENANCE	48
TROUBLESHOOTING GUIDE	50
SPECIFICATIONS	51
WARRANTY	53

FEATURES

- Tape management function
- Clog detection
- High-speed Fast Forward/Rewind
- Field recording/playback
- Audio recording is available in 6-, 18- and 30-hour modes (T-120)
- Audio recording is available in 8-, 24- and 40-hour modes (T-160)
- Autorepeat recording
- Series recording function
- Alarm recording function
- Single image recording function
- On-screen mode setting
- Integrated time date generator
- Day/Time search function
- Alarm scan/search function
- Forward/Reverse field advance function
- 30-day memory backup
- Security lock
- Recording check function
- Automatic head cleaning function
- Thread check function
- Synchronization control function
- 6, 18 and 30-hour mode recording (T-120)
- 8, 24 and 40-hour mode recording (T-160)

SRT-4040 only

- AC power operation

SRT-4040DC only

- DC power operation

When using the RS-485 interface board (VZU-40485), the VCR can be controlled from a system controller.

ACCESSORY (SRT-4040 only)

- ① Power cord

LOCATIONS OF CONTROLS AND INDICATORS

Front Panel

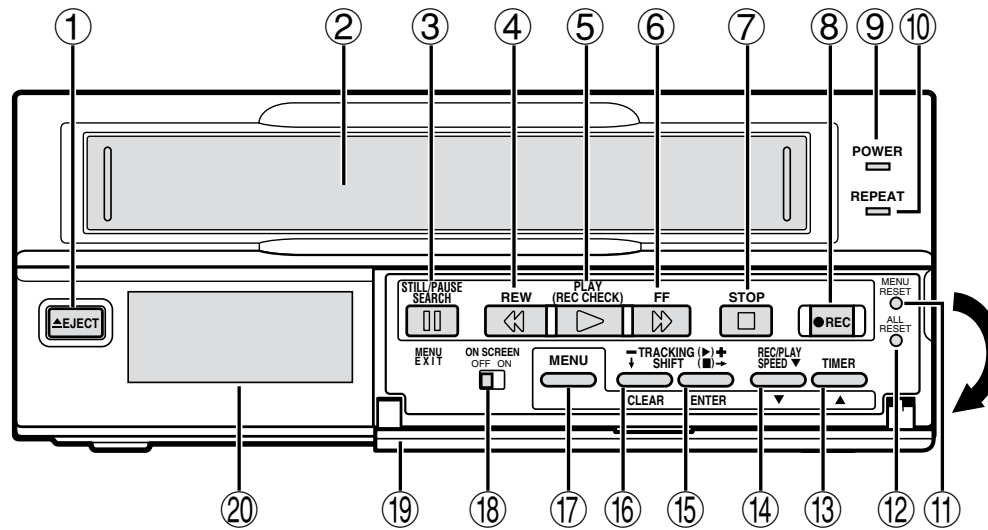

- | | |
|---|---|
| ① EJECT button | ⑪ MENU RESET button |
| ② Cassette loading slot | ⑫ ALL RESET button |
| ③ STILL/PAUSE button
SEARCH button
MENU EXIT button | ⑬ TIMER button
▲ button |
| ④ REW (rewind) button | ⑭ REC/PLAY SPEED ▼ (decrease recording/playback
speed mode) button
▼ button |
| ⑤ PLAY button
REC CHECK button | ⑮ TRACKING + button
SHIFT → button
ENTER button |
| ⑥ FF (fast forward) button | ⑯ TRACKING - button
SHIFT ↓ button
CLEAR button |
| ⑦ STOP button | ⑰ MENU button
Press this button to display the menu.
Buttons ⑬, ⑭, ⑮ and ⑯ are used for menu control. |
| ⑧ REC (record) button | ⑱ ON SCREEN switch |
| ⑨ POWER indicator | ⑲ Front door |
| ⑩ REPEAT (autorepeat recording) indicator | ⑳ Digital display panel |

LOCATIONS OF CONTROLS AND INDICATORS

Digital Display

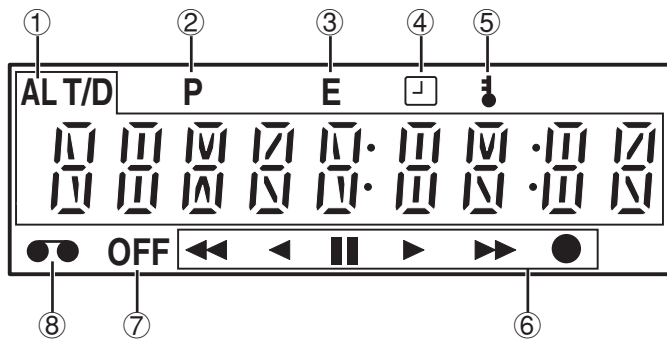

① Mode display

- Warning display

AL
M M M M M M M M M M

N flashes: Mode changed to non-recording mode while recording was in progress.

M flashes: Problem with mechanism.

C flashes: Clog detection has occurred.

V flashes: Video loss has occurred.

A flashes: Alarm recording in progress.

When alarm recording finishes, AL lights.

AL flashes during alarm recording.

NOTES:

- The warning details appear according to the (WARNING OUT/CONTROL SET) menu setting.
- The warning display has priority over other types of display. (Refer to "WARNING OUT Terminal" on page 46.)
- To cancel the display press the **STOP** button.

- Recording/playback speed mode

0

- Alarm search setting display

AL
SEARCH - 0 1 1 1

- Alarm scan setting display

AL
SEARCH

- Day/Time search setting display

T/D
SEARCH - 0 1 0 0 0 0

- Time display (No tape)

00:00

- Linear time counter display (Tape inserted)

0:00:00

- Dew display

0 0 0 0

- Tracking control display

T - -

[With the RS-485 interface board]

- Data transfer speed setting display

15 19200

- Address setting display

00 123

② Power failure indicator P

Lights after a power failure.

NOTE:

- To cancel the "P" display, press the **MENU RESET** button.

③ External input indicator

Lights when recording using the **EXT TIMER IN** input terminal.

④ Timer Recording indicator

Lights when in timer recording stand-by mode, or during a timer recording.















⑤ Security lock indicator

Lights when the security lock is engaged.

LOCATIONS OF CONTROLS AND INDICATORS

⑥ Operation Indicators

- They display the actual operation mode.

Operation Mode	Indicator
Record (REC)	●
Record pause (REC PAUSE)	● + 
Playback (PLAY)	
Still image (STILL)	 + 
Fast forward (FF)	
Rewind (REW)	
Forward picture search	 + 
Reverse picture search	 + 
Forward field advance	 + 
Reverse field advance	 + 

- Clog detection indicator 

Flashes when the recording quality deteriorates due to dirty VCR heads.

⑦ OFF indicator

Lights when the tape end has been reached after recording.

⑧ Cassette indicator

Lights when a cassette is loaded.

LOCATIONS OF CONTROLS AND INDICATORS

Back Panel (SRT-4040 only)

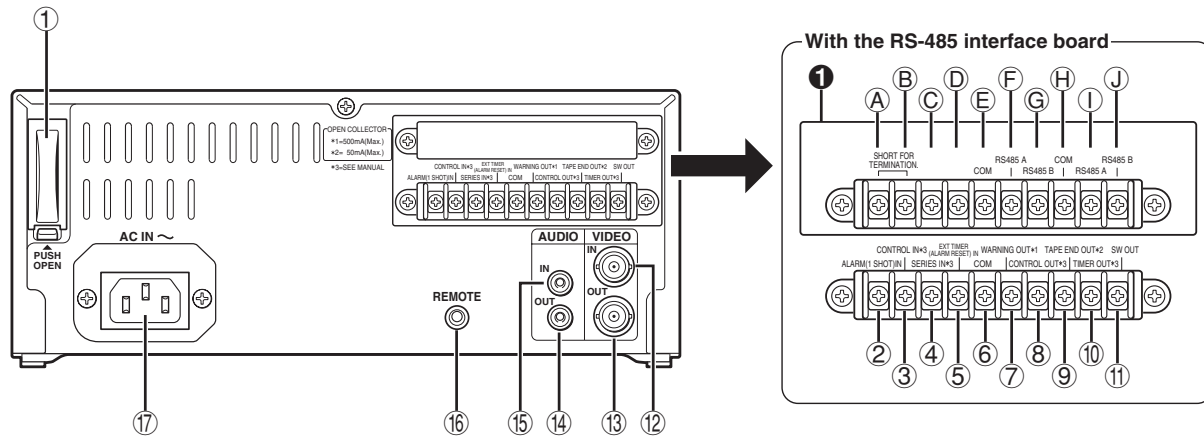

- ① Battery compartment
- ② ALARM IN (alarm trigger input) terminal
1 SHOT IN (single image recording trigger input) terminal
- ③ CONTROL IN terminal
- ④ SERIES IN (series recording trigger input) terminal
- ⑤ EXT TIMER IN (external timer trigger input) terminal
ALARM REST IN (alarm recording reset input) terminal
- ⑥ COM terminal
- ⑦ WARNING OUT (warning output) terminal
 - Signals are output when an alarm, clog detection, video loss, non-recording or mechanism problem occurs.
- ⑧ CONTROL OUT terminal
- ⑨ TAPE END OUT (tape end output) terminal
- ⑩ TIMER OUT (timer recording output) terminal
- ⑪ SW OUT (switch output) terminal
- ⑫ VIDEO IN (video input) jack
- ⑬ VIDEO OUT (video output) jack
- ⑭ AUDIO OUT (audio output) jack
- ⑮ AUDIO IN (audio input) jack
- ⑯ REMOTE (remote control input) jack
- ⑰ AC power input

- ① RS-485 interface board (sold separately)
 - Ⓐ SHORT FOR TERMINATION terminal
 - Ⓑ SHORT FOR TERMINATION terminal
 - Ⓒ Do not use
 - Ⓓ Do not use
 - Ⓔ COM terminal
 - Ⓕ RS485 A terminal
 - Ⓖ RS485 B terminal
 - Ⓗ COM terminal
 - Ⓘ RS485 A terminal
 - Ⓙ RS485 B terminal

NOTES:

- The above illustration shows the unit when the RS-485 interface board is installed. If no RS-485 interface board is installed, connectors and switches Ⓐ through to Ⓙ do not appear.
- The terminal may be damaged by a torque of 0.49 N·m (5kg·cm) or more and by using screwdriver with a tip with a diameter of 6 mm or more.
- The ③, ④, ⑧ and ⑩ terminals can be used to select the input and output signals. (Refer to "SELECTING INPUT AND OUTPUT TERMINALS" on page 38.)
- If using the ③ and ⑧ terminals, multiple VCRs can be operated by operating a single VCR. (Refer to "SYNCHRONIZATION CONTROL" on page 40.)

LOCATIONS OF CONTROLS AND INDICATORS

Back Panel (SRT-4040DC only)

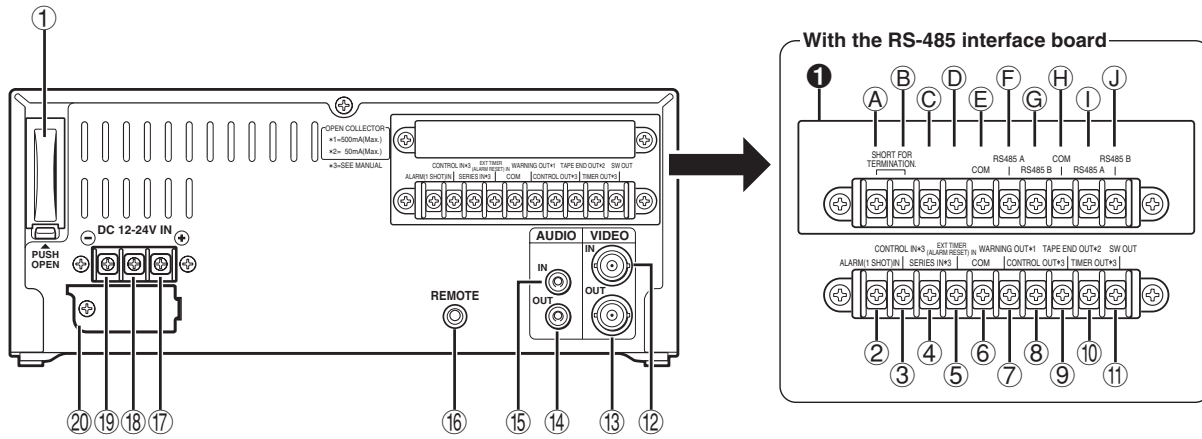

- ① Battery compartment
- ② ALARM IN (alarm trigger input) terminal
1 SHOT IN (single image recording trigger input) terminal
- ③ CONTROL IN terminal
- ④ SERIES IN (series recording trigger input) terminal
- ⑤ EXT TIMER IN (external timer trigger input) terminal
ALARM REST IN (alarm recording reset input) terminal
- ⑥ COM terminal
- ⑦ WARNING OUT (warning output) terminal
 - Signals are output when an alarm, clog detection, video loss, non-recording or mechanism problem occurs.
- ⑧ CONTROL OUT terminal
- ⑨ TAPE END OUT (tape end output) terminal
- ⑩ TIMER OUT (timer recording output) terminal
- ⑪ SW OUT (switch output) terminal
- ⑫ VIDEO IN (video input) jack
- ⑬ VIDEO OUT (video output) jack
- ⑭ AUDIO OUT (audio output) jack
- ⑮ AUDIO IN (audio input) jack
- ⑯ REMOTE (remote control input) jack
- ⑰ DC12-24V IN “+” input terminal
- ⑱ Do not use
- ⑲ DC12-24V IN “-” input terminal
- ⑳ Fuse cover

- ① RS-485 interface board (sold separately)
 - A SHORT FOR TERMINATION terminal
 - B SHORT FOR TERMINATION terminal
 - C Do not use
 - D Do not use
 - E COM terminal
 - F RS485 A terminal
 - G RS485 B terminal
 - H COM terminal
 - I RS485 A terminal
 - J RS485 B terminal

NOTES:

- The above illustration shows the unit when the RS-485 interface board is installed. If no RS-485 interface board is installed, connectors and switches A through to J do not appear.
- The terminal may be damaged by a torque of 0.49 N·m (5kg·cm) or more and by using screwdriver with a tip with a diameter of 6 mm or more.
- The ③, ④, ⑧ and ⑩ terminals can be used to select the input and output signals. (Refer to “SELECTING INPUT AND OUTPUT TERMINALS” on page 38.)
- If using the ③ and ⑧ terminals, multiple VCRs can be operated by operating a single VCR. (Refer to “SYNCHRONIZATION CONTROL” on page 40.)
- A fuse has always to be replaced by a fuse with the same ratings (250 V, 5 A)

CONNECTIONS

Connect the video camera and TV monitor as shown in the figure below.

NOTE: Before making the connections, make sure the devices are disconnected from the power outlet.

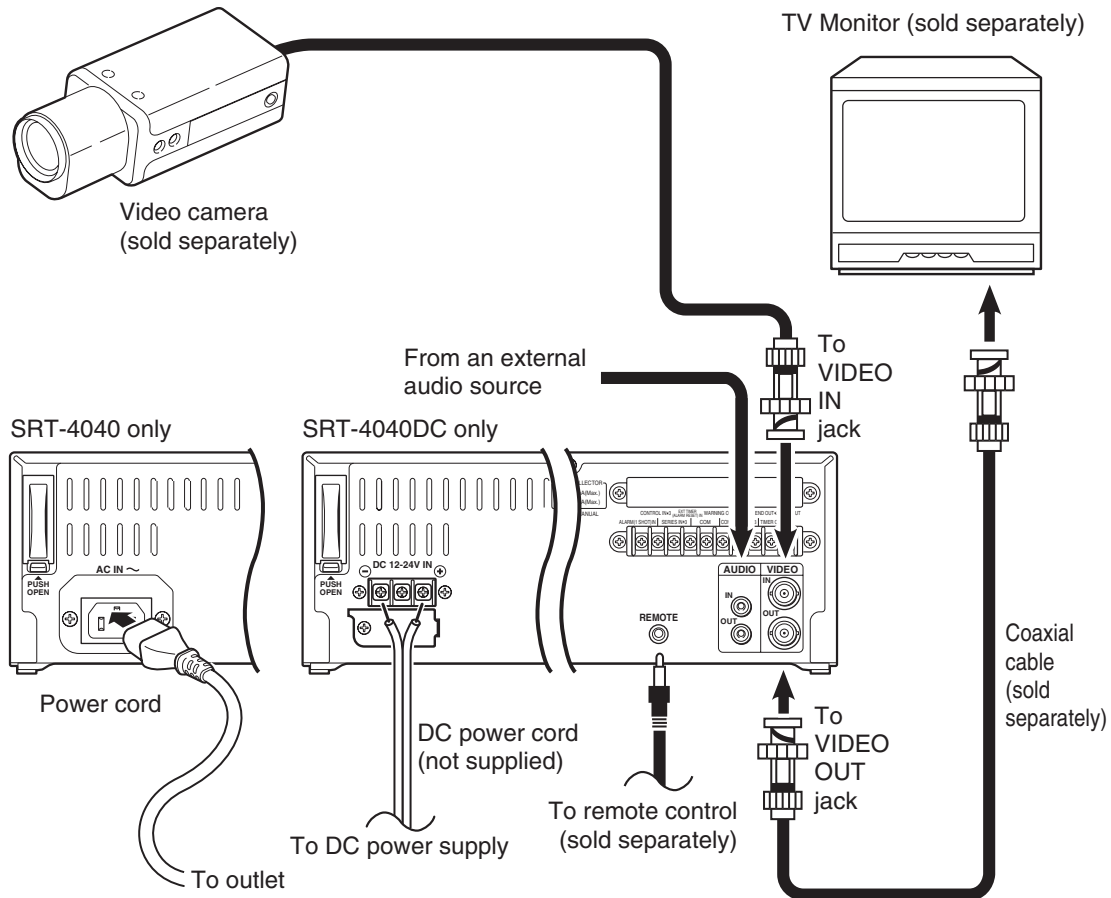

Power Cord Installation (SRT-4040 only)

- ❶ Plug the supplied power cord firmly into the AC power input **AC IN ~** socket.
- ❷ Insert the plug of this power cord into a outlet.

NOTES:

- For more details, please refer to the manuals accompanying all other devices. If the connections are not made properly, it may cause a fire or damage the equipment.
- You can use a VA-RMN01 Remote Control Unit (sold separately) to control the VCR remotely.
- If there is no video signal when the power is turned on, "NO VIDEO" will be displayed on-screen.

NOTE (SRT-4040 only):

- The grounded power cord (3-pin plug) must be connected to a grounded power outlet.

NOTES (SRT-4040DC only):

- Use a DC power cord rated A.W.G 18 (1.25 mm²) or more.
- The table below indicates the DC power source output and DC power maximum cord lengths.

DC power source output		DC power maximum cord lengths
18 V or more	2 A	6 m
12 ~ 16 V	3 A	6 m

ON-SCREEN MENU

Main Menu

To access on-screen menu

- When no menu is displayed on-screen, press the **MENU** button.

○ The **MAIN MENU** appears.

MAIN MENU

```

<MAIN MENU>
1. LANGUAGE/CLOCK SET
2. DISPLAY/SW OUT SET
3. GENERAL SET
4. WARNING OUT/CONTR.SET
5. ALARM/SERIES REC SET
6. TAPE MANAGEMENT
7. TIMER SET
8. HOLIDAY SET
9. OTHERS
    
```

- Press the **MENU EXIT** (or **MENU**) button to return to the monitor screen.

Using the ▼, ▲, ENTER and CLEAR buttons for setting

▼ (or ▲) button

- When the display is highlighted in a **MAIN MENU**, select a sub-menu.
- When the display is highlighted in a sub-menu, select a setting item.
- While the display is flashing, the selected data setting will change or the selected setting value will increase or decrease.

ENTER button

- After making the setting, press this button to save the setting and move to the next setting.
- When a **MAIN MENU** is being displayed, press this button and the sub-menu for selection will appear.
- When a menu is being displayed, press this button to change the selected setting item from highlighted to flashing.
- If there are several items on one line, press this button to confirm the setting and move to the next item (on the right).

CLEAR button

- When a sub-menu is being displayed, press this button and the **MAIN MENU** will appear.
- If there are several items on one line, press this button to move to the previous item (on the left).

Sub-menus

To enter or modify settings within a sub-menu

- When a **MAIN MENU** is being displayed, press the ▼ (or ▲) button to select one of the sub-menus, then press the **ENTER** button.

○ The selected sub-menu appears.

- Press the ▼ (or ▲) button to move the selection to the desired setting, then press the **ENTER** button.

○ The selected item flashes.

- Press the ▼ (or ▲) button to enter or modify the setting.
- Press the **MENU EXIT** button to save the settings and return to the monitor screen.

LANGUAGE/CLOCK SET menu

```

<LANGUAGE/CLOCK SET>
*LANGUAGE-LANGUE-IDIOMA
ENGLISH

*CLOCK SET
01-01-2002 TUE 00:00:00

*DAYLIGHT SET NO USE
WEEK MONTH TIME
ON 1ST-SUN 04 02:00
OFF LST-SUN 10 02:00
    
```

DISPLAY/SW OUT SET menu

```

<DISPLAY SET> SET UP
DATE Y
TIME Y
SPEED Y
ALARM COUNT Y

<SW OUT SET>
TIMING FIELD
FIELD 1
8H MODE Y
    
```

GENERAL SET menu

```

<GENERAL SET>
TAPE IN MODE STOP
TAPE END MODE REW
CLOCK ADJUST 01:00
THREAD CHECK N
VIDEO LOSS N
CLOG DETECT. N
REMOTE MENU
VIDEO COLOR
VERTICAL SYNC Y
TAPE T-160
    
```

ON-SCREEN MENU

WARNING OUT/CONTROL SET menu

```

<WARNING OUT SET>SET UP
ALARM          Y
NON REC        N
MECHA. PROBLEM Y
VIDEO LOSS     Y
CLOG DETECT.   Y

<CONTROL SET>
EJECT MODE     EJECT1
OPERATION      SLAVE
    
```

NOTES:

- The "VIDEO LOSS" line does not appear if "VIDEO LOSS" is set to "N" in the (GENERAL SET) menu.
- The "CLOG DETECT." line does not appear if "CLOG DETECT." is set to "N" in the (GENERAL SET) menu.

ALARM/SERIES REC SET menu

```

<ALARM/SERIES REC SET>
*ALARM SET
MODE          Y1
SPEED         8H
DURATION      20S
*1 SHOT SET
FIELD         1
INTERVAL      1M
*SERIES REC   N
*TAPE END OUT 8:00
    
```

TAPE MANAGEMENT menu

```

<TAPE MANAGEMENT>
*TAPE MANAGEMENT N
*PROTECT DAY     30

*REC PASS SET    10
*GROUP NO. SET   OFF
*OVERRIDE        N
    
```

TIMER SET menu

```

<TIMER SET>
WEEK START STOP SPD
SUN  ---:--:--:-- N
MON  ---:--:--:-- N
TUE  ---:--:--:-- N
WED  ---:--:--:-- N
THU  ---:--:--:-- N
FRI  ---:--:--:-- N
SAT  ---:--:--:-- N
DAILY ---:--:--:-- N
EXT  ***** N
    
```

HOLIDAY SET menu

```

<HOLIDAY SET>
1  ---:--:--:--
2  ---:--:--:--
3  ---:--:--:--
4  ---:--:--:--
5  ---:--:--:--
6  ---:--:--:--
7  ---:--:--:--
8  ---:--:--:--
9  ---:--:--:--
10 ---:--:--:--
    
```

OTHERS menu

```

<OTHERS>
*ALARM LOG
*POWER FAILURE/DEW
*TERMINAL SET SET1
*RS-485 SET
STATUS INFO. Y
ALARM INFO.  Y
    
```

NOTE:

- This is the display when the RS-485 interface board is installed. The last three lines will not appear if this board is not installed.

ALARM LOG menu

```

<ALARM LOG>          000
001  ---:--:--:--
002  ---:--:--:--
003  ---:--:--:--
004  ---:--:--:--
005  ---:--:--:--
006  ---:--:--:--
007  ---:--:--:--
008  ---:--:--:--
009  ---:--:--:--
010  ---:--:--:--
    
```

POWER FAILURE/DEW/USED TIME menu

```

<POWER FAILURE>
000 FAILURE ---:--:--:--
RECOVERY ---:--:--:--

<DEW>
000 FAILURE ---:--:--:--
RECOVERY ---:--:--:--

<USED TIME>
VIDEO          00000H
POWER          00000H
    
```

NOTES:

- Setting items are highlighted (appear in blue characters) when they are selected.
- Settings flash while they are being changed.
- When a menu is displayed, recording will not be possible.
- During recording or playback the menus cannot be displayed.
- To reset the settings of a menu to their original values, select the desired menu and then press the **MENU RESET** button.
- The USED TIME data in the (POWER FAILURE/DEW/USED TIME) menu cannot be cleared even when the **MENU RESET** button is pressed.
- Press the **MENU** button to save any settings made and switch menu screens. To display the (ALARM LOG) menu or (POWER FAILURE/DEW/USED TIME) menu, select the "ALARM LOG" or "POWER FAILURE/DEW" line in the (OTHERS) menu and then press the **ENTER** button.
- Press the **CLEAR** button while a setting item is highlighted (appears in blue characters) to return to the main menu. In the case of the (ALARM LOG) menu or the (POWER FAILURE/DEW/USED TIME) menu, to return to the (OTHERS) menu.

SETTING THE LANGUAGE AND CLOCK

Language Setting

English, French, Spanish or Portuguese can be selected by the user.

- 1 Turn the power on to all devices used.
- 2 Press the **MENU** button to display the MAIN MENU.
 - o The "1.LANGUAGE/CLOCK SET" line appears highlighted.

```

<MAIN MENU>
1. LANGUAGE/CLOCK SET
2. DISPLAY/SW OUT SET
3. GENERAL SET
4. WARNING OUT/CONTR.SET
5. ALARM/SERIES REC SET
6. TAPE MANAGEMENT
7. TIMER SET
8. HOLIDAY SET
9. OTHERS
    
```

- 3 Press the **ENTER** button.
 - o The (LANGUAGE/CLOCK SET) menu appears.
 - o "ENGLISH" is highlighted (appears in blue characters).

```

<LANGUAGE/CLOCK SET>
*LANGUAGE-LANGUE-IDIOMA
ENGLISH

*CLOCK SET
01-01-2002 TUE 00:00:00

*DAYLIGHT SET NO USE
WEEK MONTH TIME
ON 1ST-SUN 04 02:00
OFF LST-SUN 10 02:00
    
```

- 4 Press the **ENTER** button.
 - o The display color for the selected item returns to the original color and flashes.
- 5 Press the ▼ (or ▲) button to select the language of your choice.
 - To set the next item, press the **ENTER** button, then press the ▼ (or ▲) button to select the next setting.
- 6 When finished, press the **MENU EXIT** button to return to the monitor screen.

Clock setting

Example: To set the clock to October 15, 2002 at 3:20 PM (15:20).

- 1 Follow steps 1 to 3 under "Language Setting".
- 2 Press the ▼ (or ▲) button until the "CLOCK SET" setting is highlighted (appears in blue characters).
- 3 Press the **ENTER** button.
 - o The month position starts flashing.
- 4 Press the ▼ (or ▲) button to set the month (10), then press the **ENTER** button.
 - o The day of week is set automatically.
- 5 Press the ▼ (or ▲) button to set the day (15), then press the **ENTER** button.
- 6 Press the ▼ (or ▲) button to set the year (2002), then press the **ENTER** button.
- 7 Press the ▼ (or ▲) button to set the hours (15 for 3 PM), then press the **ENTER** button.
 - o Unit uses 24hours format.
- 8 Press the ▼ (or ▲) button to set the minutes (20), then press the **ENTER** button.

```

<LANGUAGE/CLOCK SET>
*LANGUAGE-LANGUE-IDIOMA
ENGLISH

*CLOCK SET
10-15-2002 TUE 15:20:00

*DAYLIGHT SET NO USE
WEEK MONTH TIME
ON 1ST-SUN 04 02:00
OFF LST-SUN 10 02:00
    
```

- If a wrong setting has been entered, press the **CLEAR** button to move to the setting to be changed, then press the ▼ (or ▲) button to enter the correct setting.
- 9 For accurate clock setting, press the ▼ button timed with a time broadcast or other accurate time signal. This will start the seconds counting from 00.
 - To set the next item, press the **ENTER** button, then press the ▼ (or ▲) button to select the next setting.
 - 10 Press the **MENU EXIT** button to return to the monitor screen.

NOTE:

- In STOP mode, press and hold the **STOP** button then press the **TRACKING** – button to reset the minutes and seconds to 00 (to the closest hour). For example, between 13:30:00 and 14:29:59 the clock is reset to 14:00:00.

SETTING THE LANGUAGE AND CLOCK

Automatic Daylight Saving Time Adjustment

- ① Follow steps ① to ③ under “Language Setting” on page 12.

```

<LANGUAGE/CLOCK SET>
*LANGUAGE-LANGUE-IDIOMA
  ENGLISH

*CLOCK SET
  10-15-2002 TUE 15:20:00

*DAYLIGHT SET      NO USE
  WEEK  MONTH  TIME
ON  1ST-SUN  04  02:00
OFF LST-SUN  10  02:00
    
```

- ② Press the ▼ (or ▲) button until the “DAYLIGHT SET” setting is highlighted (appears in blue characters), then press the **ENTER** button.

- ③ Press the ▼ (or ▲) button to set the auto daylight saving time/standard time adjustment, then press the **ENTER** button.

NO USE No daylight saving time/standard time adjustment is made.

USE The auto daylight saving time/standard time adjustment is made.

- If using the “USE” setting, continue with steps ④ to ⑦.

- ④ Press the ▼ (or ▲) button to select the “ON” line setting, then press the **ENTER** button.

- The “1ST” of the “ON” line flashes.

- ⑤ Set the day the daylight saving time adjustment is made.

- Press the ▼ (or ▲) button to set the week, then press the **ENTER** button.
1ST, 2ND, 3RD, 4TH or LST (first, second, third, fourth or last)
- Press the ▼ (or ▲) button to set the day of week, then press the **ENTER** button.
SUN, MON, TUE, SAT (Sunday, Monday, Tuesday....Saturday)
- Press the ▼ (or ▲) button to set the month the daylight saving time adjustment is made, then press the **ENTER** button.
01, 02,.....11, 12 (for January, February.....November, December)
- Press the ▼ (or ▲) button to set the time (hour) the daylight saving time adjustment is made, then press the **ENTER** button.
- Press the ▼ (or ▲) button to set the time (minutes) the daylight saving time adjustment is made, then press the **ENTER** button.

- ⑥ Press the ▼ (or ▲) button to select the “OFF” line setting, then press the **ENTER** button.

- The “LST” of the “OFF” line flashes.

- ⑦ Following the same procedure as above (step ⑥), set when the time is changed back from daylight saving time to standard time.

- ⑧ Press the **MENU EXIT** button.

Factory setting:

	WEEK	MONTH	TIME
ON	1ST-SUN	04	02:00 (AM)
OFF	LST-SUN	10	02:00 (AM)

SUPERIMPOSE DISPLAY

Selecting the Superimpose Display

You can select to display or not the date, time, tape speed mode and number of alarm recordings.

- 1 Turn the power on to all devices used.
- 2 Press the **MENU** button to display the MAIN MENU.
- 3 Press the **▼** (or **▲**) button to select the "2.DISPLAY/SW OUT SET" line, then press the **ENTER** button.

o The (DISPLAY/SW OUT SET) menu appears.

<DISPLAY SET>	SET UP
DATE	Y
TIME	Y
SPEED	Y
ALARM COUNT	Y
<SW OUT SET>	FIELD
TIMING	1
FIELD	1
8H MODE	Y

- 4 Press the **ENTER** button.
- 5 Press the **▼** (or **▲**) button to select the desired mode, then press the **ENTER** button.
 - SET UP Set each item (Individual)
 - ALL Y To set all items to "Y"
 - ALL N To set all items to "N"

o If using the "SET UP" setting, continue with steps 6 to 8.
- 6 Press the **▼** (or **▲**) button until the item to be changed is highlighted, then press the **ENTER** button.
- 7 Press the **▼** (or **▲**) button to set "Y" (displayed) or "N" (not displayed), then press the **ENTER** button.
 - DATE The date appears
 - TIME The time appears
 - SPEED The recording /playback speed mode appears
 - ALARM COUNT The number of alarm recordings appears
- 8 Repeat steps 6 and 7 when setting other items.
- 9 When finished, press the **MENU EXIT** button.

NOTE:

- If the **ON SCREEN** switch is set to the "ON" position, the items for which "Y" have been set are recorded. The items for which "N" was set at step 7 above are not recorded.

Changing the Superimpose Display Position

- 1 Turn the power on to all input devices to the VCR.
- 2 Set the **ON SCREEN** switch to the "ON" position.
 - o The superimpose display appears.

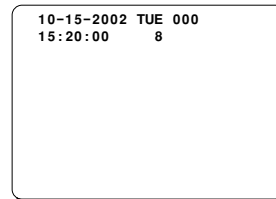

- 3 To change the display position, press the **SHIFT →** (or **↓**) button.
 - o The display will move towards the right (or the bottom).

NOTES:

- If the **SHIFT →** (or **↓**) button is kept pressed for 1 second or more, the display will move at a faster speed.
- The display position cannot be changed during recording.

VIDEO CASSETTE TAPES

Use only video cassette tapes bearing the VHS logo. This VCR was primarily designed for use with T-120 and T-160 cassette tapes. It is recommended that you use T-120 or T-160 standard grade VHS video cassette tapes for optimal performance.

NOTE:

- If using longer tapes (i.e. T-180) the tape travel will not be as stable and that may cause problems.

Handling Cassette Tapes

The cassette tapes should always be stored vertically in their cases, away from high temperatures, magnetic fields, direct sunlight, dirt, dust and locations subject to mold formation.

Do not tamper with the cassette mechanism and never touch the tape with your fingers.

Protect the cassette tapes from shocks and strong vibrations.

To Protect your Recordings

After having recorded a tape, if you wish to keep the recording, use a flat-tripped screwdriver to break off the erasure-prevention tab on the cassette.

To record again on a tape without an erasure-prevention tab, cover the hole with adhesive tape.

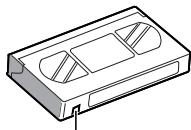

Erasure-prevention tab

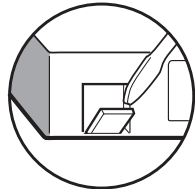

Loading

- 1 Place the cassette, label side up, in the loading slot. Gently push the center of the cassette until it is loaded automatically.

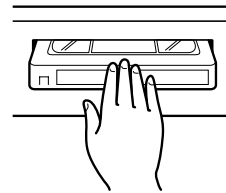

- The time display will switch to the reset counter "0:00:00" display.
- The cassette indicator "●●" lights on the digital display.

NOTE:

- If you try to record on a cassette without an erasure-prevention tab, the VCR will eject the cassette.

Unloading

- 1 In stop mode, press the **EJECT** button.
 - The cassette is automatically ejected.

NOTES:

- Do not insert any other object in the cassette loading slot, as that may cause injury and damage to the VCR.
- If your hand gets stuck in the cassette loading slot, unplug the power cord and consult the dealer where the unit was bought. Do not forcibly pull your hand out as that may cause severe injuries.

Precautions concerning the video cassette tapes

- Do not use tapes that are damaged, tapes that have been cut and repaired or tapes that have been altered in any way.
- Some rewinders may tangle the tape, and therefore their use is not recommended.
- When tapes are recorded over and over again, the recording quality will deteriorate. Refer to "Concerning the Number of Times Tapes can be Rerecorded on" on page 21, and replace the tape with a new tape as required.

VIDEO CASSETTE TAPES

Correct tape thread check function

This function checks to make sure that the cassette has been correctly loaded so that recording can be carried out.

NOTES:

- After the cassette tape is loaded, the mechanism will operate for about 5 seconds to check that the tape has been threaded (loaded) correctly automatically and the cassette indicator “●” will flash during that period. If the tape is not loaded properly, the cassette will be ejected.
- If the **REC**, **PLAY**, **FF**, **REW** or **STOP** button is pressed during the tape thread check operation, the command will only be executed after the tape thread has been checked. Only the **EJECT** button will operate while the tape thread is being checked.
- If “TAPE IN MODE” in the (GENERAL SET) menu is set to “REC”, the recording indicator “●” will light while the tape thread is being checked. However, recording will only start after the tape thread check is completed.

- 1 Press the **MENU** button to display the MAIN MENU.
- 2 Press the ▼ (or ▲) button to select the “3.GENERAL SET” line, then press the **ENTER** button.
 - The (GENERAL SET) menu appears.

<GENERAL SET>	
TAPE IN MODE	STOP
TAPE END MODE	REW
CLOCK ADJUST	01:00
THREAD CHECK	N
VIDEO LOSS	N
CLOG DETECT.	N
REMOTE	MENU
VIDEO	COLOR
VERTICAL SYNC	Y
TAPE	T-160

- 3 Press the ▼ (or ▲) button until the “THREAD CHECK” setting is highlighted, then press the **ENTER** button.
- 4 Press the ▼ (or ▲) button to select the desired mode, then press the **ENTER** button.
 - N The correct tape thread check function is off
 - Y The correct tape thread check function is on
- 5 Press the **MENU EXIT** button.

Setting the Action to Take When a Cassette is Loaded

You can set the mode the VCR will go into when a cassette is loaded.

- 1 Press the **MENU** button to display the MAIN MENU.
- 2 Press the ▼ (or ▲) button to select the “3.GENERAL SET” line, then press the **ENTER** button.
 - The (GENERAL SET) menu appears.
- 3 Press the ▼ (or ▲) button until the “TAPE IN MODE” setting is highlighted, then press the **ENTER** button.
- 4 Press the ▼ (or ▲) button to select the desired mode, then press the **ENTER** button.
 - STOP When tape inserted the VCR, stays in stop mode
 - REC When tape inserted the VCR, goes into recording mode
- 5 Press the **MENU EXIT** button.

Setting the Type of Tape Used

- 1 Press the **MENU** button to display the MAIN MENU.
- 2 Press the ▼ (or ▲) button to select the “3.GENERAL SET” line, then press the **ENTER** button.
 - The (GENERAL SET) menu appears.
- 3 Press the ▼ (or ▲) button until the “TAPE” setting is highlighted, then press the **ENTER** button.
- 4 Press the ▼ (or ▲) button to set the tape length, then press the **ENTER** button.
 - T-160 When using a T-160 cassette tape
 - T-120 When using a T-120 cassette tape
- 5 Press the **MENU EXIT** button.

TAPE MANAGEMENT

This VCR is equipped with a tape management function. Using this function you can protect previous recordings and prevent overuse of the tape by controlling the tape protection term (number of days), the maximum number of re-recordings of the tape and the recording group. For details on how to set this function, refer to "Setting the Tape Management Function".

PROTECT DAY: To set the number of days before the tape can be rerecorded over.

REC PASS SET: To limit the number of rerecordings, in order to maintain a good image quality.

GROUP NO. SET: To manage tapes belonging to different recording groups.

NOTES:

- Before using this function, make sure that the clock is set properly.
- To use the tape management function, it must be set before recording is started.
- The tape management data is recorded at the beginning of the tape.

Operation

When the **REC** button is pressed, the VCR will rewind the tape to the beginning, and will play back some of the tape to check for the presence of tape management data (no image appears). The message "T. MANAGE. CHK" appears on-screen while the presence and type of data are being checked.

NOTE:

- When performing program timer recording, single image recording and alarm recording, the tape management function will not operate even if it is active.

If no tape management data is present on the tape

Recording will start according to the settings in the (TAPE MANAGEMENT) menu.

When recording starts, the updated tape management data is recorded onto the tape.

If the tape has already been recorded on, the message "USED TAPE" will flash on-screen until recording starts.

If tape management data is present on the tape

The tape management data is checked and if there is no conflict, the VCR will rewind the tape to the beginning, then recording starts and the updated tape management data is recorded onto the tape. The message "T. MANAGE. OK" appears on-screen while the tape is being rewound and the tape management data is being recorded.

If a conflict is found when the tape management data is checked, the (TAPE MANAGEMENT) menu is displayed and the conflicting setting will flash. This menu will show the settings taken from the data recorded on the tape and not the current data settings held in the VCR's (TAPE MANAGEMENT) menu setting. Refer to "Tape Management Conflict Display" for detailed information.

NOTE:

- If the VCR is set for alarm recordings, alarms will be recorded based on the different settings. If an alarm signal is input while "T. MANAGE. CHK" is displayed, the alarms will be recorded after feeding a certain amount of tape but the data will not be recorded (updated). If an alarm signal is input during data recording, the alarms will be recorded after data recording.

IMPORTANT NOTES:

- If the tape management data cannot be read, the VCR will switch to stop mode and "DATA NG" will be displayed on-screen. This may indicate that the beginning of the tape (data recording/reading section) is damaged and the tape may be unusable. The message "DATA NG" will disappear when the **EJECT** or **PLAY** button is pressed.
- **Set the security lock function to on in order to protect the security of this feature.**

TAPE MANAGEMENT

Setting the Tape Management Function

- ① Press the **MENU** button to display the MAIN MENU.
- ② Press the ▼ (or ▲) button to select the "6.TAPE MANAGEMENT" line, then press the **ENTER** button.
 - The (TAPE MANAGEMENT) menu appears.

<TAPE MANAGEMENT>	
*TAPE MANAGEMENT	N
*PROTECT DAY	30
*REC PASS SET	10
*GROUP NO. SET	OFF
*OVERRIDE	N

- ③ Press the **ENTER** button.
- ④ Press the ▼ (or ▲) button to select the desired mode, then press the **ENTER** button.
 - N. The tape management function is not active.
 - Y. The tape management function is active.

When setting to "Y", please continue with the settings below.
- ⑤ Press the ▼ (or ▲) button until the "PROTECT DAY" setting is highlighted, then press the **ENTER** button.
- ⑥ Press the ▼ (or ▲) button to select the desired number of days to protect the tape, then press the **ENTER** button.
 - OFF The tape is not protected
 - 1-255 . . . Number of days to protect the tape (prevent over-recording), from the date of the last recording on the tape (or the last expected recording date (calculated using the tape length (T-120 or T-160) and the recording speed)).

NOTE:

- Since the last expected recording date is a calculated date (using the tape length (T-120 or T-160) and the recording speed), it may be different from the actual last recording date, due to other settings such as alarm recordings, program timer recordings and holiday settings.

- ⑦ Press the ▼ (or ▲) button until the "REC. PASS SET" setting is highlighted, then press the **ENTER** button.
- ⑧ Press the ▼ (or ▲) button to select the desired number of re-recording times, then press the **ENTER** button.
 - OFF The number of re-recording times will not be checked.
 - 1-100 . . . Maximum number of re-recording times. (Refer to "Concerning the Number of Times Tapes can be Rerecorded on" on page 21.)

NOTES:

- Since data is read before it is recorded, the number of times will be incremented even if the recording is stopped before the end.
 - During autorepeat recording, the re-recording times count will be updated every time the tape is rewound to the beginning. Autorepeat recording will proceed even if the count exceeds the "REC PASS SET" setting.
- ⑨ Press the ▼ (or ▲) button until the "GROUP NO. SET" setting is highlighted, then press the **ENTER** button.
 - ⑩ Press the ▼ (or ▲) button to select the desired group number, then press the **ENTER** button.
 - OFF The group number will not be checked.
 - 1-15 Group number setting.
 - ⑪ Press the ▼ (or ▲) button until the "OVERRIDE" setting is highlighted, then press the **ENTER** button.
 - ⑫ Press the ▼ (or ▲) button to select the desired override mode, then press the **ENTER** button. (Refer to "Tape Management Conflict Display" on the next page.)
 - N. Only **EJECT** button operation is accepted after a conflict has occurred.
 - Y. The next operation is accepted after a conflict has occurred. This will override setting.
 - ⑬ Press the **MENU EXIT** button.

NOTES:

- Once the tape management data is recorded on tape, it cannot be changed.
- The criteria (condition) for allowing recording will be based on the data recorded on the tape and not the settings in the (TAPE MANAGEMENT) menu.

TAPE MANAGEMENT

Tape Management Conflict Display

If a conflict that prevents recording is found when the tape management function checks the tape data, the (TAPE MANAGEMENT) menu appears with the conflicting setting flashing and the VCR go into the stop mode.

NOTES:

- If "OVERRIDE" is set to "N" (No), the conflicting setting is displayed flashing and the message (PRESS EJECT) appears at the bottom of the screen. Recording under these conditions is not possible. Press the **EJECT** button to eject the tape. To record on the same tape, set the "OVERRIDE" setting to "Y" and modify the conflicting setting, then insert the same tape and press the **REC** button. However, if only "PROTECT DAY" and "REC PAS SET" are modified, the menu will be displayed again. Press the **REC** button one more time to start recording. Recording starts and the tape data is updated.

Conflict display sample

<TAPE MANAGEMENT>	
*TAPE MANAGEMENT	Y
*PROTECT DAY	30
LAST M/D	NEXT M/D
10/15	11/15
*REC PASS SET	10
PASS COUNT	10
*GROUP NO. SET	7
REC GR. NO.	8
*OVERRIDE	N
(PRESS EJECT)	

- If the "OVERRIDE" is set to "Y" (Yes), the (TAPE MANAGEMENT) menu is displayed and conflicting setting preventing recording will flash and the VCR will switch to stop mode. To enter recording mode, press the **REC** button.

PROTECT DAY CONFLICT

The tape is protected, and the tape protection term (ex. 30 days) is not yet over.

Under "LAST M/D", the date of the last recording on the tape (or the last expected recording date (calculated using the tape length (T-120 or T-160) and the recording speed)) is displayed.

Under "NEXT M/D", the date when it will be possible to record on the tape again is displayed.

REC PASS SET CONFLICT

The set number of recording passes has been reached.

The "PASS COUNT" shows the number of recording passes on the tape (ex. since the maximum recording passes number is set to "10", this prevents further recording.)

NOTES:

- When conducting Autorepeat recording, if the "PASS COUNT" exceeds 100, "101*" will be displayed flashing.
- If using a tape recorded previously on a different type of VCR (no tape data), when the set number of recordings is exceeded, "USED" will flash next to the "PASS COUNT" number.

GROUP NO. SET CONFLICT

The group numbers do not match.

The "REC GR. NO." shows the tape recording group number (ex. this tape belongs to a different recording group number 8 than the one set 7.)

NORMAL RECORDING

Normal Recording

Before starting

- Turn the power on to all devices used.
- Load a cassette tape with its erasure-prevention tab intact.
- Set the **ON SCREEN** switch to the "ON" position.

NOTES:

- If "TAPE IN MODE" is set to "REC" in the (GENERAL SET) menu, recording will start.
- Set the "TAPE" item in the (GENERAL SET) menu according to the duration of the tape used.

- 1 Press the **REC/PLAY SPEED** ▼ button to set the recording speed mode.
 - *The recording speed mode appears on-screen and on the digital display.*
- 2 Press the **REC** button.
 - *The record indicator "●" lights.*
 - *Recording starts.*
 - *If the tape end is reached while recording, "OFF" is displayed on the digital display and the unit goes into the mode set at the "TAPE END MODE" setting in the (GENERAL SET) menu. To cancel the "OFF" display, press the **STOP**, **EJECT**, **FF**, **REW** or **PLAY** button.*
 - *When the end of the tape is reached, the **TAPE END OUT** terminal output will be 0V. To cancel the output, press the **STOP** button.*
- 3 To stop recording, press the **STOP** button.

NOTES:

- A tape recording made on this VCR may not play back with the same degree of clarity on a real time video cassette recorder from another manufacturer.
- If you press the **REC** button and the loaded cassette has no erasure-prevention tab, the VCR will eject the cassette.

[Recording Speed Mode]

(When the "TAPE" is set to "T-160" in the (GENERAL SET) menu)

Recording speed mode (hour mode)	Maximum recording duration (hours)	Recording interval (second)	Audio recording	Tape motion
8	8	1/60	Possible	Continuous
24	24	3/60		
40	40	5/60		
000	Single image recording		Not possible	Intermittent

(When the "TAPE" is set to "T-120" in the (GENERAL SET) menu)

Recording speed mode (hour mode)	Maximum recording duration (hours)	Recording interval (second)	Audio recording	Tape motion
6	6	1/60	Possible	Continuous
18	18	3/60		
30	30	5/60		
000	Single image recording		Not possible	Intermittent

NOTE:

- The tape speed display will vary according to the "TAPE" item in the (GENERAL SET) menu setting. In this manual, all the examples and displays used are for when the "TAPE" item is set to "T-160". If set to "T-120", please refer to the table above for the corresponding durations and displays.
For example, if the recording speed mode is "8", then the corresponding recording speed when set to "T-120" will be "6", and, the counter reading of 8:00:00 will be 6:00:00 when set to "T-120".

NORMAL RECORDING

Record Pause

Recording can be interrupted temporarily.

- ① Press the **STILL/PAUSE** button during recording.
 - *The pause/still indicator "II" flashes.*

NOTES:

- The image appears on-screen but it is not recorded.
- If a recording pause continues for 5 minutes or more, the VCR will switch to stop mode to avoid damaging the tape.

- ② To resume recording, press the **REC** button, or press the **STILL/PAUSE** button again.

Recording Check

The image being recorded can be checked.

- ① During recording, press the **REC CHECK** button.
 - *The tape will be rewound and then played back. The VCR will then return to the previous recording mode.*

NOTE:

- During recording check operations, recording is suspended momentarily.

Tape Counter Notes:

- There is no tape counter indication for the blank portions of the tape.
- In the 8-hour recording speed mode only, the tape counter indicates real hours, minutes and seconds.
- In the other recording speed modes, the tape counter indication is a ratio of the 8-hour mode base indication. (In 40-hour recording mode, each "second" of the tape counter actually represents approximately $40/8 = 5$ real seconds.)
- There may be a slight discrepancy between the position shown on the tape counter and the actual tape position.
- When rewinding the tape past the "0:00:00" position, a minus (-) sign will be displayed.

Concerning the Number of Times Tapes can be Rerecorded on

Depending on the recording speed mode, the tape must be replaced after a certain number of recording times.

Refer to the table below for the maximum number of times a tape can be recorded on.

Recording speed mode (hour mode)	Maximum number of recording times (with a standard grade tape)
6, 8	100
18, 24	50
30, 40	50
000	1

NOTES:

- The maximum number of recording times will vary depending on the location and kind of tape used. Verify the recording quality and replace the tape when the quality starts to deteriorate. The maximum number of recording times indicated above are based on test tapes (T-120 and T-160) used by the company.
- It is recommended that tape be changed at least as often as in the above table to provide good picture quality in the mode above.

NORMAL RECORDING

Clog Detection

This VCR is equipped with a clog detection function.

The recording quality is monitored automatically. When the heads are dirty and the recording quality deteriorates, the output at the **WARNING OUT** terminal becomes 0 V (Low) (Refer to "WARNING OUT Terminal" on page 46), the "●" indicator flashes on the digital display.

Setting the clog detection

- ❶ Press the **MENU** button to display the MAIN MENU.
- ❷ Press the ▼ (or ▲) button to select the "3.GENERAL SET" line, then press the **ENTER** button.
 - *The (GENERAL SET) menu appears.*

<GENERAL SET>	
TAPE IN MODE	STOP
TAPE END MODE	REW
CLOCK ADJUST	01:00
THREAD CHECK	N
VIDEO LOSS	N
CLOG DETECT.	N
REMOTE	MENU
VIDEO	COLOR
VERTICAL SYNC	Y
TAPE	T-160

- ❸ Press the ▼ (or ▲) button until the "CLOG. DETECT." setting is highlighted, then press the **ENTER** button.
- ❹ Press the ▼ (or ▲) button to select the desired mode, then press the **ENTER** button.
 - N. Recording quality is not monitored
 - Y. Recording quality is monitored
- ❺ Press the **MENU EXIT** button.

NOTES:

- To cancel the "●" indicator display and reset the **WARNING OUT** terminal output, press the **STOP** button (Refer to "WARNING OUT Terminal" on page 46).
- Clog detection is not possible if recording in 8-hour mode.

Action to Take when the Video Signal Deteriorates

If there is no video signal during recording or when a menu is not displayed (in stop, fast forward or rewind modes, etc.), "VIDEO LOSS" can be displayed on-screen. If in the (WARNING OUT/CONTROL SET) menu, "VIDEO LOSS" is set to "Y", the output at the **WARNING OUT** terminal becomes 0V (Low) (Refer to "WARNING OUT Terminal" on page 46).

- ❶ Press the **MENU** button to display the MAIN MENU.
- ❷ Press the ▼ (or ▲) button to select the "3.GENERAL SET" line, then press the **ENTER** button.
 - *The (GENERAL SET) menu appears.*
- ❸ Press the ▼ (or ▲) button until the "VIDEO LOSS" setting is highlighted, then press the **ENTER** button.
- ❹ Press the ▼ (or ▲) button to select the desired mode, then press the **ENTER** button.
 - N. The video loss warning is not active.
 - Y. The video loss warning is active.
- ❺ Press the **MENU EXIT** button.

NORMAL RECORDING

Setting the Mode at the End of the Tape

You can select the mode on the VCR when the tape reaches the end during recording.

- ① Press the **MENU** button to display the MAIN MENU.
- ② Press the ▼ (or ▲) button to select the "3.GENERAL SET" line, then press the **ENTER** button.
 - The (GENERAL SET) menu appears.

<GENERAL SET>	
TAPE IN MODE	STOP
TAPE END MODE	REW
CLOCK ADJUST	01:00
THREAD CHECK	N
VIDEO LOSS	N
CLOG DETECT.	N
REMOTE	MENU
VIDEO	COLOR
VERTICAL SYNC	Y
TAPE	T-160

- ③ Press the ▼ (or ▲) button until the "TAPE END MODE" setting is highlighted, then press the **ENTER** button.
- ④ Press the ▼ (or ▲) button to select the desired mode, then press the **ENTER** button.
 - **Setting when not using Autorepeat recording**
 - REW. Rewinds the tape to the beginning, then goes to stop mode
 - STOP Goes to stop mode
 - EJECT The cassette is ejected
 - **Setting when using Autorepeat recording**
 - REPEAT1. . . Autorepeat recording mode is automatically canceled if there was an alarm trigger
 - REPEAT2. . . Autorepeat recording mode is active even if there was an alarm trigger
- ⑤ Press the **MENU EXIT** button.

Setting the video input signal

The video input signal during recording can be set to either color or black & white.

- ① Press the **MENU** button to display the MAIN MENU.
- ② Press the ▼ (or ▲) button to select the "3.GENERAL SET" line, then press the **ENTER** button.
- ③ Press the ▼ (or ▲) button until the "VIDEO" setting is highlighted, then press the **ENTER** button.
- ④ Press the ▼ (or ▲) button to select the desired mode, then press the **ENTER** button.
 - COLOR For recording in color
 - B/W For recording in black & white
- ⑤ Press the **MENU EXIT** button.

NOTES:

- Set to "COLOR" for systems which include color signals (including cases where black & white signals are mixed in), and set to "B/W" for systems which only use black & white signals.
- Use the same setting for recording and playback.
- If tapes that have been recorded in black & white are played back when the setting is at "COLOR", the recordings will not be played back in color.
- If using a black & white camera, set to "B/W". Recordings will not be made in color even if "COLOR" is set.

AUTOREPEAT RECORDING

Autorepeat Recording

The same tape can be recorded over many times.

- Follow the **Before starting** steps, under "NORMAL RECORDING".
- ❶ Press the **MENU** button to display the MAIN MENU.
- ❷ Press the ▼ (or ▲) button to select the "3.GENERAL SET" line, then press the **ENTER** button.
 - *The (GENERAL SET) menu appears.*

<GENERAL SET>	
TAPE IN MODE	STOP
TAPE END MODE	REW
CLOCK ADJUST	01:00
THREAD CHECK	N
VIDEO LOSS	N
CLOG DETECT.	N
REMOTE	MENU
VIDEO	COLOR
VERTICAL SYNC	Y
TAPE	T-160

- ❸ Press the ▼ (or ▲) button until the "TAPE END MODE" setting is highlighted, then press the **ENTER** button.
- ❹ Press the ▼ (or ▲) button to set to "REPEAT1" or "REPEAT2" (Refer to "Setting the Mode at the End of the Tape." on page 23), then press the **ENTER** button.
- ❺ Press the **MENU EXIT** button.
 - *The REPEAT indicator lights.*
- ❻ Press the **REC/PLAY SPEED ▼** button to set the recording speed mode.
- ❼ Press the **REC** button.
 - *Recording starts. When the tape end is reached, the VCR will rewind it to the beginning, and recording will resume.*
 - *When the end of the tape is reached, "OFF" will be displayed and TAPE END OUT terminal output will 0 V, until the rewinding operation starts.*

NOTES:

- If there is an alarm trigger during autorepeat recording, "AL" and "A" flash on the digital display and alarm recording starts. (Refer to "ALARM RECORDING" on page 25.)
- If the "TAPE END MODE" setting is "REPEAT1", the REPEAT indicator will go off if there is an alarm trigger. After alarm recording, the recording will continue to the end of the tape then it will be rewound to the beginning and stop. "OFF" will be displayed on the digital display.
To turn off the "OFF" display, press the **STOP**, **EJECT**, **FF**, **REW** or **PLAY** button.
- If "AL" appears on the digital display and the "TAPE END MODE" setting is "REPEAT1", autorepeat recording is not possible.

ALARM RECORDING

By connecting the **ALARM IN** terminal to a normally open door switch, an interphone, etc., a recording can be done only when necessary.

Alarm Recording Setting

Alarm recording is performed when there is an input (trigger) at the **ALARM IN** terminal.

- Make all necessary connections.
- The alarm triggers are received while in recording and stop modes.
- Follow the **Before starting** steps, under "NORMAL RECORDING".

- 1 Press the **MENU** button to display the MAIN MENU.
- 2 Press the ▼ (or ▲) button to select the "5.ALARM/SERIES REC SET" line, then press the **ENTER** button.

o The (ALARM/SERIES REC SET) menu appears.

<ALARM/SERIES REC SET>	
*ALARM SET	
MODE	Y1
SPEED	8H
DURATION	20S
*1 SHOT SET	
FIELD	1
INTERVAL	1M
*SERIES REC	N
*TAPE END OUT	8:00

- 3 Press the ▼ (or ▲) button until the "MODE" setting is highlighted, then press the **ENTER** button.
- 4 Press the ▼ (or ▲) button to set the desired alarm recording mode, then press the **ENTER** button.
 - Y1. Alarm recording is done when there is an alarm trigger.
 - Y2. Alarm recording is done only when there is an alarm trigger during duration of programmed timer recording.
 - Y3. Alarm recording is done only if there is an alarm trigger and the VCR is not in programmed timer recording mode.
 - Y4. Alarm recording is done only when there is an alarm trigger during programmed timer recording duration. VCR comes on records only for alarm duration. Timer recording is not possible.
 - N. Alarm recording is not performed even if there is an alarm trigger.

- 5 Press the **ENTER** button.

- 6 Press the ▼ (or ▲) button to set the desired alarm recording speed, then press the **ENTER** button.
 - 8H (6H). 8-hour (6-hour) mode recording
 - 24H (18H) 24-hour (18-hour) mode recording
 - 40H (30H) 40-hour (30-hour) mode recording
 - NC Recording at the speed already set

- Indicated in brackets are the settings for when "TAPE" is set to "T-120" in the (GENERAL SET) menu.

- 7 Press the **ENTER** button.

- 8 Press the ▼ (or ▲) button to set the desired alarm recording duration (20S, 40S, 1M, 2M, 3M, 4M, 5M, or CC), then press the **ENTER** button.
 - 20S-5M. Recording only for the displayed duration
 - CC Recording as long as the alarm signal is being input (minimum 5 seconds)

- 9 Press the **MENU EXIT** button.

NOTES:

- During alarm recording all buttons are disabled.
- If "OFF" appears on the digital display, alarm recording is not possible in order to prevent the recorded tape to be recorded over. To cancel the "OFF" display, press the **STOP, EJECT, FF, REW** or **PLAY** button.
- If an alarm trigger is received while alarm recording is in progress, recording duration for the second alarm will be calculated from that point. The alarm counter will register the alarm, but it will not be found during an alarm scan and alarm search.
- If there is a power failure during alarm recording, and the power is restored within the recording set duration, alarm recording will continue.
- If the alarm recording duration is short, the alarms may not be found during an alarm scan or an alarm search. If the alarms are going to be reviewed using alarm scan or alarm search, then in 8-hour mode, 20-second or more recording duration should be used.
- To do alarm recording during series recording, set "MODE" to "Y1" or "Y3". Alarm recording will be conducted only if the VCR is recording.
- If the recording speed mode is "000", the recording will be in 8-hour mode irrespective of the alarm recording speed mode setting.

ALARM RECORDING

Alarm Recording Reset Function

To stop the recording of an alarm, close the connection between the **ALARM RESET IN** terminal and the **COM** terminal during alarm recording.

Alarm Recording Counter Display

- During alarm recording, "AL" and "A" will be flashing on the digital display.
- If a superimpose display is being displayed and "ALARM COUNT" has been set to "Y" in the (DISPLAY/SW OUT SET) menu, the number of alarm recordings will flash on the monitor screen.
- The maximum display number of alarm recordings is "999". At the next alarm recording the counter will indicate "000".
- When the (ALARM LOG) menu appears, press the **MENU RESET** button to reset the alarm counter to "000" (all the data of the (ALARM LOG) menu is reset).

Connections to the ALARM IN Terminal

- Alarm input signal
Connect a make-contact (no voltage) switch between the **ALARM IN** and **COM** terminals.

Checking the Alarm Recordings Time

- 1 Press the **MENU** button to display the MAIN MENU.
- 2 Press the ▼ (or ▲) button to select the "9.OTHERS" line, then press the **ENTER** button.
 - The (OTHERS) menu appears.

```

<OTHERS>
*ALARM LOG
*POWER FAILURE/DEW
*TERMINAL SET SET1
    
```

- 3 Press the ▼ (or ▲) button to select the "ALARM LOG" line, then press the **ENTER** button.
 - The (ALARM LOG) menu appears.
 - The number of alarm recordings, and the 10 most recent alarm recording times are displayed.

Example

```

<ALARM LOG>          010
001 12-25 19:00
002 11-25 23:00
003 10-25 15:00
004 10-25 08:00
005 10-25 06:00
006 10-22 19:00
007 10-22 17:15
008 10-22 15:45
009 10-20 10:00
010 10-18 12:00
    
```

- Continue pressing the ▼ (or ▲) button to display the next (or previous) 10 alarm recording entries. When the number of alarm recording entries reaches 100, the older ones are erased as new ones are memorized.

- 4 Press the **MENU EXIT** button.

NOTE:

- If the **MENU RESET** button is pressed while the (ALARM LOG) menu is displayed, the displayed data is erased. "AL" will be erased from the digital display.

ALARM RECORDING

Alarm Search

To go to the beginning of a desired alarm recording.

- ❶ Press the **SEARCH** button during stop mode.
 - "AL SEARCH 01" appears on screen.
- ❷ Press the ▼ (or ▲) button to set the desired alarm number (01 to 99), then press the **FF** (or **REW**) button.
 - The desired alarm is searched for and a still image of the beginning of the alarm recording appears on-screen.

NOTE:

- The alarm number is relative to the actual tape position. (Please refer to the illustration below.)

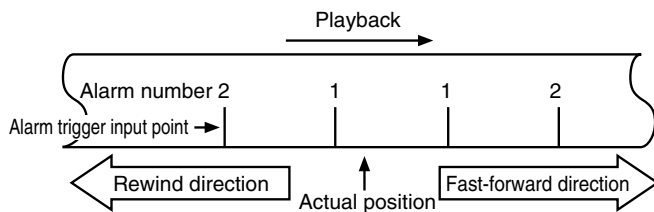

- ❸ Press the **PLAY** button.
 - Playback starts.

NOTES:

- If the end of the tape is reached during a search, the tape will rewind and stop. If the beginning of the tape is reached, it will stop.
- This function does not operate when a warning display appears on the digital display.

Alarm Scan

To look for an alarm recording by viewing the first 5 seconds of each alarm recording.

- ❶ Press the **SEARCH** button twice during stop mode.
 - "AL SCAN" will be displayed on screen.
- ❷ Press the **FF** (or **REW**) button.
 - The unit will advance (or rewind) the tape at high speed and playback the first 5 seconds of every alarm recording.
 - To cancel the alarm scan mode, press the **STOP** button.
- ❸ While the desired recording is being played back, press the **PLAY** button.
 - Playback starts and alarm scan mode is canceled.

NOTES:

- If the end of the tape is reached during a scan, the tape will rewind and stop. If the beginning of the tape is reached, it will stop.
- This function does not operate when a warning display appears on the digital display.

PROGRAM TIMER RECORDING

There are three program timer recording methods, daily recording, weekly recording or recording on certain days of the week.

Example 1: To record on every Saturday from 9:00 AM to 5:00 PM (17:00), in 24-hour mode (recording speed).

- Follow the **Before starting** steps, under "NORMAL RECORDING".
- ❶ Press the **MENU** button to display the MAIN MENU.
- ❷ Press the ▼ (or ▲) button to select the "7.TIMER SET" line, then press the **ENTER** button.
 - The (TIMER SET) menu appears.

<TIMER SET>			
WEEK	START	STOP	SPD
SUN	---	---	N
MON	---	---	N
TUE	---	---	N
WED	---	---	N
THU	---	---	N
FRI	---	---	N
SAT	---	---	N
DAILY	---	---	N
EXT	*****	*****	N

- ❸ Press the ▼ (or ▲) button until the "SAT" (Saturday) line is highlighted, then press the **ENTER** button.
- ❹ Press the ▼ (or ▲) button to change the weekday, then press the **ENTER** button.
 - If no change, press the **ENTER** button.
 - The recording start hour position starts flashing.

NOTE:

- All of the lines other than the bottom line can be set to "SUN", "MON", "TUE", "WED", "THU", "FRI", "SAT", "DAILY", "MO-SA" (Monday to Saturday) or "MO-FR" (Monday to Friday).

- ❺ Press the ▼ (or ▲) button to set the recording start hour (ex: 09), then press the **ENTER** button.
 - The recording start minutes position starts flashing.
- ❻ Press the ▼ (or ▲) button to set the recording start minutes (ex: 00), then press the **ENTER** button.
 - The recording stop hour position starts flashing.
- ❼ Press the ▼ (or ▲) button to set the recording stop hour (ex: 17), then press the **ENTER** button.
 - The recording stop minutes position starts flashing.

- ❽ Press the ▼ (or ▲) button to set the recording stop minutes (ex: 00), then press the **ENTER** button.
 - The "SPD" (recording speed) position will start flashing.

NOTE:

- If the set stop time is earlier than or the same time as the set start time, the VCR will consider the stop time to be the following day, and "T" will be displayed next to the recording stop time.

- ❾ Press the ▼ (or ▲) button to select the recording speed mode (ex: 24), then press the **ENTER** button.
 - "N" will start flashing.

- ❿ Press the ▼ (or ▲) button to select the desired program timer recording mode (Y), then press the **ENTER** button.

Y. Recording will take place
 N. Recording will not take place

<TIMER SET>			
WEEK	START	STOP	SPD
SUN	---	---	N
MON	---	---	N
TUE	---	---	N
WED	---	---	N
THU	---	---	N
FRI	---	---	N
SAT	09:00	17:00	24 Y
DAILY	---	---	N
EXT	*****	*****	N

- Repeat steps ❸ to ❿ to program timer recordings for other days of the week.
- If a wrong setting has been entered, press the **CLEAR** button to move to the setting to be changed, then press the ▼ (or ▲) button to enter the correct setting.

- ⓫ Press the **MENU EXIT** button.
- ⓬ Press the **TIMER** button.

○ The timer recording indicator "□" will light on the digital display. The VCR is now in timer recording stand-by mode.

NOTE:

- To modify, cancel or stop timer recording, press the **TIMER** button to cancel the timer recording mode.

PROGRAM TIMER RECORDING

A timer recording of more than 24 hours can only be set on the 7th (SAT) and 8th (DAILY) lines of the (TIMER SET) menu.

Example 2: To record every week from Saturday at 9:00 PM (21:00) to Monday at 7:00 AM, in 40-hour mode (recording speed).

- Follow the **Before starting** steps, under “NORMAL RECORDING”.
- ① Follow steps ① and ② under “PROGRAM TIMER RECORDING” on page 28.
 - *The (TIMER SET) menu appears.*

<TIMER SET>			
WEEK	START	STOP	SPD
SUN	--:--	--:--	--- N
MON	--:--	--:--	--- N
TUE	--:--	--:--	--- N
WED	--:--	--:--	--- N
THU	--:--	--:--	--- N
FRI	--:--	--:--	--- N
SAT	--:--	--:--	--- N
DAILY	--:--	--:--	--- N
EXT	*****	*****	--- N

- ② Press the ▼ (or ▲) button until the “SAT” (Saturday) line is highlighted, then press the **ENTER** button.
- ③ Press the ▼ (or ▲) button, to set the desired start day of the week (ex: SAT), then press the **ENTER** button.
- ④ Press the ▼ (or ▲) button to set the recording start hour (ex: 21), then press the **ENTER** button.
- ⑤ Press the ▼ (or ▲) button to set the recording start minutes (ex: 00), then press the **ENTER** button.
- ⑥ Press the ▼ (or ▲) button to set “**” for the recording stop hour, then press the **ENTER** button.
 - *The rest of the line settings will change to “**:** ** *”, the day of the next line will change to the next day and the start time will change to “**:**” automatically.*
- ⑦ Press the ▼ (or ▲) button to set the desired stop day of the week (ex: MON), then press the **ENTER** button.
- ⑧ Press the ▼ (or ▲) button to set the recording stop hour (ex: 07), then press the **ENTER** button.
- ⑨ Press the ▼ (or ▲) button to set the recording stop minutes (ex: 00), then press the **ENTER** button.
- ⑩ Press the ▼ (or ▲) button to select the recording speed mode (ex: 40), then press the **ENTER** button.

- ⑪ Press the ▼ (or ▲) button to select “Y”.

<TIMER SET>			
WEEK	START	STOP	SPD
SUN	--:--	--:--	--- N
MON	--:--	--:--	--- N
TUE	--:--	--:--	--- N
WED	--:--	--:--	--- N
THU	--:--	--:--	--- N
FRI	--:--	--:--	--- N
SAT	21:00	**:**	*** *
MON	**:**	07:00	40 Y
EXT	*****	*****	--- N

- ⑫ Press the **MENU EXIT** button.
- ⑬ Press the **TIMER** button.

PROGRAM TIMER RECORDING

Setting the Holidays

By setting the holidays, timer recording will be conducted on those days, as set for Sundays.

- ❶ Press the **MENU** button to display the MAIN MENU.
- ❷ Press the ▼ (or ▲) button to select the "8.HOLIDAY SET" line, then press the **ENTER** button.

○ The (HOLIDAY SET) menu appears.

<HOLIDAY SET>	
1	11
2	12
3	13
4	14
5	15
6	16
7	17
8	18
9	19
10	20

- ❸ Press the ▼ (or ▲) button to select the desired line, then press the **ENTER** button.
- ❹ Press the ▼ (or ▲) button to set month of the holiday, then press the **ENTER** button.
- ❺ Press the ▼ (or ▲) button to set day of the holiday, then press the **ENTER** button.
 - Repeat steps ❸ to ❺ to set up to 20 holidays.
- ❻ Press the **MENU EXIT** button.

NOTES:

- If setting holidays, be sure that a timer recording is set for Sunday. If not, this function will not operate. If the setting for Sundays extends over Sunday and another day, or if the timer recording period extends before and after a Sunday, timer recording will only be carried out within the Sunday setting time (until midnight).
- If a timer recording for Sundays is entered, the holidays timer recording will not function if the program timer recording mode is set to "N".
- To erase a setting, follow the same procedure as above, but at step ❹ and ❺, enter "--" instead of a setting.

Changing a Program Timer Recording

- ❶ Follow steps ❶ and ❷ under "PROGRAM TIMER RECORDING" on page 28.
- ❷ Press the ▼ (or ▲) button until the setting (line) to be changed is highlighted, then press the **ENTER** button.
- ❸ Press the **ENTER** button, until the setting to correct is flashing.
- ❹ Press the ▼ (or ▲) button, to correct the setting.
- ❺ Press the **MENU EXIT** button, then press the **TIMER** button.

To Cancel a Program Timer Recording

- ❶ Follow steps ❶ and ❷ under "PROGRAM TIMER RECORDING" on page 28.
- ❷ Press the ▼ (or ▲) button until the setting (line) to be canceled is highlighted, then press the **ENTER** button.
- ❸ Press the **ENTER** button repeatedly, until "Y" is flashing.
- ❹ Press the ▼ (or ▲) button, to select "N".
- ❺ Press the **MENU EXIT** button, then press the **TIMER** button.

To cancel all program timer recordings

- ❶ Follow steps ❶ and ❷ under "PROGRAM TIMER RECORDING" on page 28.
- ❷ Press the **MENU RESET** button.
 - All programmed timer recordings are erased.
- ❸ Press the **MENU EXIT** button.

PROGRAM TIMER RECORDING

NOTES:

- During timer recording or timer recording stand-by, all the buttons on the VCR, except the **TIMER** button and the buttons to set/cancel the security lock (see page 37), are disabled.
- If the power fails, the recording will be interrupted. When the power is restored, the recording will resume if the stop time has not yet been reached, and "P" will be displayed on the digital display. The VCR internal battery is completely recharged after the VCR has been connected to a live outlet for 48 hours, and it will maintain all the VCR settings memory for up to 30 days.
- Set the timer recordings so that the recording times do not overlap. If they do, the one with the earliest recording start time will have priority. (See chart below.)

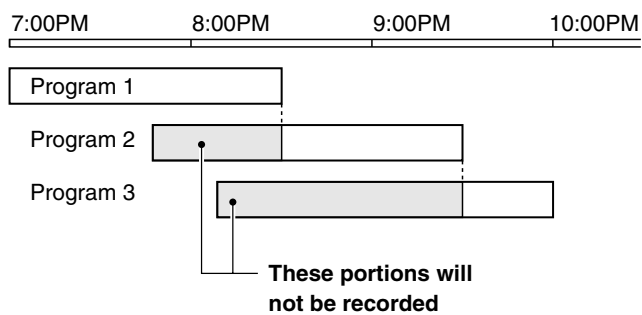

- If no timer recording is set or a cassette without erasure-prevention tab is loaded, when the **TIMER** button is pressed the timer recording indicator "⏸" will start flashing.
- If "OFF" is displayed on the digital display, timer recording is not possible in order to prevent the recorded tape to be recorded over.
- If the recording speed mode has been set to "000", single image recordings will be made.

RECORDING USING AN EXTERNAL TIMER INPUT

Recording can be controlled by an external start/stop signal input at the **EXT TIMER IN** terminal.

While there is input at the **EXT TIMER IN** terminal, the external input indicator "E" will light on the digital display and the input will be recorded. Recording will stop when there are no more input signals.

Example 3: To record using the signal input at the **EXT TIMER IN** terminal, in 24-hour mode.

- Follow the **Before starting** steps, under "NORMAL RECORDING".

NOTE:

- External timer input recording can only be set on the "EXT" line of the (TIMER SET) menu.
- ❶ Follow steps ❶ and ❷ under "PROGRAM TIMER RECORDING" on page 28.
- ❷ Press the ▼ (or ▲) button until the "EXT" line is highlighted, then press the **ENTER** button.
- ❸ Press the ▼ (or ▲) button to select the recording speed mode (ex: 24), then press the **ENTER** button.
- ❹ Press the ▼ (or ▲) button to select "Y".

<TIMER SET>			
WEEK	START	STOP	SPD
SUN	--:--	--:--	--- N
MON	--:--	--:--	--- N
TUE	--:--	--:--	--- N
WED	--:--	--:--	--- N
THU	--:--	--:--	--- N
FRI	--:--	--:--	--- N
SAT	--:--	--:--	--- N
DA I L Y	--:--	--:--	--- N
EXT	*****	*****	24 Y

- ❺ Press the **MENU EXIT** button.
- ❻ Press the **TIMER** button.

NOTES:

- Alarm recording is not possible using this function.
- Alarm recording reset function is not possible using this function.
- Other timer recordings using the standard procedure can also be programmed.

SERIES RECORDING

Using 2 VCRs or more, the series recording function lets you switch recording from one unit to the next (only with VCRs of the same model as this one).

Series Recording Setup

- Connect 2 VCRs or more as illustrated below.
- Set the "TAPE" item in the (GENERAL SET) menu according to the duration of the tape used.
- ❶ Press the **REC/PLAY SPEED ▼** button to set the recording speed mode.
- ❷ Set the following items as indicated.

Item	VCR No.1	VCR No.2 and on
Cassette tape	Loaded	Loaded
Operation mode	Stop	Stop
"TAPE END MODE"(in (GENERAL SET) menu)	REW, STOP or EJECT	REW, STOP or EJECT
"SERIES REC" (in (ALARM/SERIES REC SET) menu)	Y (YES)	Y (YES)
Timer recording	OFF (not set)	OFF (not set)
Security lock	Canceled	Set

- ❸ Press the **REC** button on VCR No.1.
 - *Recording will start in series recording mode.*
- ❹ Set the security lock on VCR No.1.

Operation

The output signal at the **TAPE END OUT** terminal will be present either at the point when the counter reading is 8:00:00 or when VCR No. 1 reaches the end of the tape, whichever is first.

When this signal is received by VCR No. 2, it will start recording.

When the tape end is reached, operation is then carried out according to the "TAPE END MODE" setting in the (GENERAL SET) menu.

NOTES:

- When using tapes that are based on the VHS standard, a single tape can be used to record 8:00:00 or more based on the counter setting (6:00:00 or more when the "TAPE" in (GENERAL SET) menu is set to "T-120").
- If "SERIES REC" is set to "N" in the (ALARM/SERIES REC SET) menu, series recording will not be possible.
- The counter must start from the beginning of tape.
- Even if "OFF" is displayed, series recording will be conducted if there is an input at the **SERIES IN** terminal.

Loop recording

- Connect the output from the **TAPE END OUT** terminal of the last VCR to the **SERIES IN** terminal of the first VCR.
- The "TAPE END MODE" in (GENERAL SET) menu should be set to "REW" for all units without fail.
- In loop recording mode, the tape will be re-recorded over. If you need to keep the recorded information, please eject the tape after recording is complete and insert a new tape.

Connection

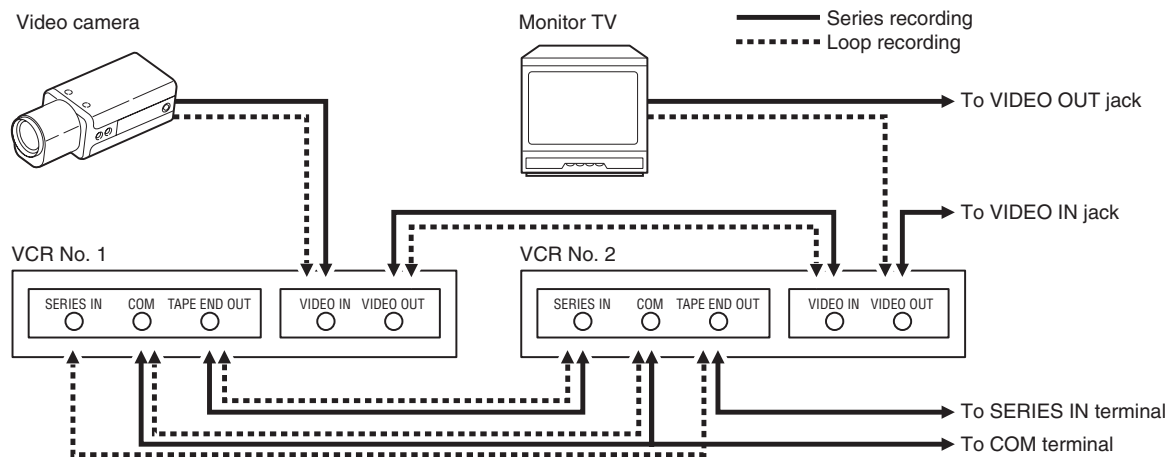

SINGLE IMAGE RECORDING

The single image recording function of this VCR can be used to create image data files or animations.

Single Image Recording Setup

- 1 In stop mode, press the **REC/PLAY SPEED** ▼ button, to set the recording speed to "000".
- 2 Press the **MENU** button to display the MAIN MENU.
- 3 Press the ▼ (or ▲) button to select the "5.ALARM/SERIES REC SET" line, then press the **ENTER** button.
 - o The (ALARM/SERIES REC SET) menu appears.

<ALARM/SERIES REC SET>	
*ALARM SET	
MODE	Y1
SPEED	8H
DURATION	20S
*1 SHOT SET	
FIELD	1
INTERVAL	1M
*SERIES REC	N
*TAPE END OUT	8:00

- 4 Press the ▼ (or ▲) button until the "FIELD" setting is highlighted, then press the **ENTER** button.
- 5 Press the ▼ (or ▲) button to set the number of fields (images) to record every time (1, 2, 3, 4, 5, 10, 30, 60), then press the **ENTER** button.
- 6 Press the **ENTER** button.
- 7 Press the ▼ (or ▲) button to set the interval between each image recording (1M, 2M, 3M), then press the **ENTER** button.
- 8 Press the **MENU EXIT** button.
- 9 Press the **REC** button.
 - o The single image recording mode will be activated (the VCR will be in recording stand-by mode).
- 10 Press the **REC** button one more time, or send a trigger through the **1 SHOT IN** terminal on the back panel, to start the single image recording.

NOTE:

- If a setting other than "1" is selected for "FIELD" at step 5, recording will be done in 120-hour mode. The recording speed cannot be modified.
- 11 When finished, press the **STOP** button.

NOTES:

- The trigger at the **1 SHOT IN** terminal should be on for 0.1 sec. or more.
- The trigger interval at the **1 SHOT IN** terminal varies according to the number of images to record, but should be over 1 sec.
- Alarm recording is not possible during single image recording.
- During the "INTERVAL" period set for single image recording, the **WARNING OUT** terminal will not be 0 V even if the "NON REC" on the (WARNING OUT/CONTROL SET) menu is set to "Y".
- If a single image recording trigger is not received (or if the **REC** button is not pressed) during the duration set for "INTERVAL", single image recording will be conducted automatically after the set duration.
- If a single image recording trigger is received (or if the **REC** button is pressed) during the duration set for "INTERVAL", single image recording will be conducted immediately.
- When using the **1 SHOT IN** terminal, connect a make-contact switch (no voltage) between the **1 SHOT IN** and **COM** terminals.

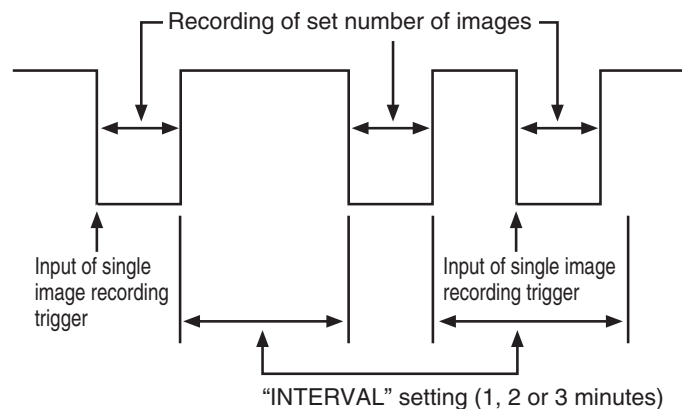

NORMAL PLAYBACK

Normal Playback

- ❶ Turn on the power to the VCR and TV monitor.
- ❷ Load the video cassette tape.
- ❸ Press the **REC/PLAY SPEED ▼** button to select the playback speed mode.
 - *The selected playback speed mode is displayed on the digital display.*

NOTES:

- A slow motion effect or accelerated playback effect can be achieved by using a slower or faster playback speed than the speed used for recording.
 - If the playback speed mode is set to "000", playback (step ❸) will not be possible.
- ❹ Press the **PLAY** button.
 - *Playback starts.*
 - *If necessary, adjust the tracking to eliminate the noise from the picture.*
 - *If the image is unstable (rolling vertically), adjust the vertical lock control to correct.*
 - ❺ To stop playback, press the **STOP** button.
 - *To advance (or rewind) the tape, press the **FF** (or **REW**) button.*

NOTES:

- A tape recorded on a real time video cassette recorder produced by another manufacturer may not play back with the same degree of clarity on this unit.
- When used with a multiplexer in 24- or 40-hour mode playback (or when the "TAPE" in (GENERAL SET) menu is set to "T-120", in 18- or 30-hour mode playback), the image may roll vertically. In such a case, set "VERTICAL SYNC" to "N" in menu (GENERAL SET) menu.
- When a tape recorded with a time lapse VCR is played back, the playback speed mode display and playback time may be different due to the recording speed mode.

Tracking Control

If there is noise in the image during playback,

- ❶ While looking at the playback picture, press the **TRACKING+** button repeatedly to minimize the noise.
- ❷ If it cannot be minimized, press the **TRACKING-** button repeatedly.

NOTE:

- This function does not operate when a warning display appears on the digital display.

Vertical Lock Control

During still image mode,

- ❶ Press the **TRACKING+** button repeatedly to reduce the vertical rolling of the image.
- ❷ If it cannot be corrected, press the **TRACKING-** button repeatedly.

NOTE:

- This function does not operate when a warning display appears on the digital display.

Audio Playback

- Audio playback is only possible in 8-hour, 24-hour and 40-hour modes (or when the "TAPE" in (GENERAL SET) menu is set to "T-120", in 6-hour, 18-hour and 30-hour modes).
- The playback speed has to be the same as the recording speed, for normal playback of the audio.

SPECIAL PLAYBACK

Picture Search (Forward and Reverse)

- ❶ Press the **FF** (or **REW**) button, during normal playback.
 - *The image can be seen while the tape is advanced (or rewound) at high speed.*
- ❷ To return to normal playback, press the **PLAY** button.

NOTES:

- During picture search, noise (horizontal bars) will appear in the picture.
- The sound is muted.

Still Image

- ❶ Press the **STILL/PAUSE** button, during normal playback.
 - *A still image can be viewed.*
- ❷ To return to normal playback, press the **PLAY** button.

NOTES:

- If still mode continues for 5 minutes or more, the VCR will go into stop mode to avoid damaging the tape.
- If the image is unstable (rolling vertically), adjust the vertical lock control to correct.
- The sound is muted.

Field Advance (Forward and Reverse)

- ❶ Press the **FF** (or **REW**) button, during still image mode.
 - *The still image is advanced (or rewound) of one image (field).*
- ❷ To return to normal playback, press the **PLAY** button.

NOTES:

- During reverse field advance, noise will appear in the picture.
- If field advance mode continues for 5 minutes or more, the VCR will switch to stop mode to avoid damaging the tape.
- The sound is muted.

DAY/TIME SEARCH

Day/Time Search

This searches for a specified day/time for still images to be played back.

- ① Press the **SEARCH** button three times during stop mode.
 - "T/D SEARCH 01 00:00" will be displayed on screen.
- ② Press the ▼ (or ▲) button to set the desired day, then press the **ENTER** button.
- ③ Press the ▼ (or ▲) button to set the desired hour, then press the **ENTER** button.
- ④ Press the ▼ (or ▲) button to set the desired minutes.

NOTES:

- The setting can be made in 10 minutes increments only.
 - For recordings made on other VCRs, the exact time may not be found even if the minutes are entered. For tapes recorded on older models of VCRs produced by this company (the ones without a minutes setting for the day/time search function), make sure to set the minutes to "00".
- ⑤ Press the **FF** (or **REW**) button.
 - The desired day/time is searched and a still image of the recording will appear on-screen.
 - ⑥ Press the **PLAY** button.
 - Playback will start.

NOTES:

- If the end of the tape is reached during a search, the tape will rewind and stop. If the beginning of the tape is reached, it will stop.
- The alarm and day/time data are recorded on the tape in a similar format. If they overlap, the alarm data will have the priority. Therefore, when searching for a day/time when an alarm recording was done, the day/time search will not stop at the desired location. In such a case, use alarm scan to find the desired recording location.
- The day/time search function may not operate correctly if searching for a timer recording time or if the clock on the recording VCR has been adjusted using the **CLOCK ADJUSTMENT** function.
- If a recording on a tape extends for over a one month period, the same day may be present twice on the tape. If such a day is searched, since there is no month search setting, the desired day may not be found.
- This function does not operate when a warning display appears on the digital display.

SECURITY LOCK

The security lock function is designed to prevent accidental stopping of recording if the **STOP** button is pressed inadvertently.

- ① While holding the **SHIFT** → button, press the **REC/PLAY SPEED** ▼ button.
 - "🔒" appears on the digital display.

To cancel the security lock, while holding the **SHIFT** → button, press the **REC/PLAY SPEED** ▼ button, "🔒" will be erased from the digital display.

NOTES:

- While the security lock is engaged all commands, except the one to cancel the security lock, are disabled.
- The security lock cannot be engaged while a menu is displayed.
- The security lock will be cancelled by pressing the **ALL RESET** button.

CLOCK ADJUSTMENT

The time for the second and subsequent VCRs can be set to the same time as the first VCR.

A signal from a separate device can also be used to set the time for the second and subsequent VCRs to the same time as the first VCR. When using the signal from a separate device to set the time, input a 0 V signal to the **CONTROL IN** terminal of the first VCR for 100 ms or longer.

- 1 Press the **MENU** button to display the MAIN MENU.
- 2 Press the ▼ (or ▲) button to select the "3.GENERAL SET" line, then press the **ENTER** button.
- 3 Press the ▼ (or ▲) button until the "CLOCK ADJUST" setting is highlighted, then press the **ENTER** button.
- 4 Press the ▼ (or ▲) button to set the hour at which the adjustment will be conducted, then press the **ENTER** button.

NOTE:

- The clock adjustment cannot be set to "00:00".

Example

<GENERAL SET>	
TAPE IN MODE	STOP
TAPE END MODE	REW
CLOCK ADJUST	03:00
THREAD CHECK	N
VIDEO LOSS	N
CLOG DETECT.	N
REMOTE	MENU
VIDEO	COLOR
VERTICAL SYNC	Y
TAPE	T-160

- 5 Press the **MENU EXIT** button.
The setting procedure on the first VCR is now completed.
- 6 Repeat the procedure for all the other VCRs, setting "CLOCK ADJUST" (to the same time as set on the first VCR).

NOTE:

- This function will not operate on the day the daylight saving/standard time is changed.

Connection

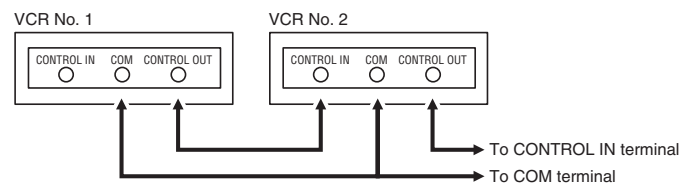

SELECTING INPUT AND OUTPUT TERMINALS

The input and output terminal signals can be selected so that the VCR can be connected to older models of VCR.

- 1 Press the **MENU** button to display the MAIN MENU.
- 2 Press the ▼ (or ▲) button to select the "9. OTHERS" line, then press the **ENTER** button.
 - o The (OTHERS) menu appears.

<OTHERS>	
*ALARM LOG	
*POWER FAILURE/DEW	
*TERMINAL SET	SET1

- 3 Press the ▼ (or ▲) button until the "TERMINAL SET" setting is highlighted, then press the **ENTER** button.
- 4 Press the ▼ (or ▲) button to select the desired mode, then press the **ENTER** button.

SET1 According to indication on back panel. (Select when not connecting to an older model.)

SET2 **CONTROL IN** is set to **CLOCK IN**, **SERIES IN** is set to **EJECT IN**, **CONTROL OUT** is set to **CLOCK OUT** and **TIMER OUT** is set to **EJECT OUT**. (Select when connecting to an older model.)

- 5 When finished, press the **MENU EXIT** button.

NOTE:

- If set to "SET2", the "SERIES REC" line will not appear in the (ALARM/SERIES REC SET) menu.

SETTING THE CASSETTE EJECT MODE

Cassette Eject Setup

When using two or more VCRs, the cassette tapes of all the VCRs or some of the VCRs can be ejected at the same time.

NOTE:

- "TERMINAL SET" in the (OTHERS) menu should always be set to "SET2".
- ❶ Press the **MENU** button to display the MAIN MENU.
- ❷ Press the ▼ (or ▲) button to select the "4.WARNING OUT/CONTR. SET" line, then press the **ENTER** button.
 - The (WARNING OUT/CONTROL SET) menu appears.

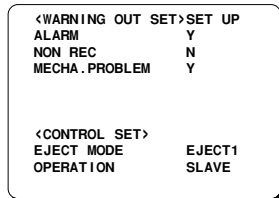

- ❸ Press the ▼ (or ▲) button until the "EJECT MODE" setting is highlighted, then press the **ENTER** button.
- ❹ Press the ▼ (or ▲) button to select the desired cassette eject mode, then press the **ENTER** button.
 - EJECT1 The cassette is ejected only if the VCR is not in recording or recording pause mode.
 - EJECT2 The cassette is ejected only if the VCR is in stop mode.
- ❺ Press the ▼ (or ▲) button until the "OPERATION" setting is highlighted, then press the **ENTER** button.
- ❻ Press the ▼ (or ▲) button to select the desired operation, then press the **ENTER** button.
 - SLAVE The function is restricted to only the VCR being operated.
 - MASTER The function is applied to the VCR being operated and all VCRs that are connected after it.
- ❼ Press the **MENU EXIT** button.

NOTE:

- The **EJECT** button will not be operative during recording mode.

Connection

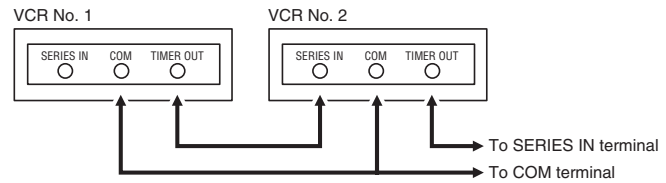

Eject input (SERIES IN) terminal

- Depending on the "EJECT MODE" setting in the (WARNING OUT/CONTROL SET) menu (see "Cassette Eject Setup"), the cassette loaded into the VCR can be ejected when there is input to this terminal.

Eject output (TIMER OUT) terminal

- A signal is output from this terminal when the **EJECT** button is pressed (if the VCR is set up as the "MASTER" VCR; see step ❹ under "Cassette Eject Setup") or when there is input (a trigger) at the **SERIES IN** terminal, even if the security lock is set or a cassette is not loaded.

NOTES:

- The terminal names and signals are different from the usual setting.
- Names in brackets apply to terminals on the rear panel.

SYNCHRONIZATION CONTROL

When two or more of this model of VCR are connected together, the VCRs can be operated simultaneously just by operating the VCR that has been set to "MASTER", without using a system controller (sold separately).

There are two modes available: operator mode and administrator/installer mode. The operations that can be carried out in each mode are different.

NOTES:

- The operation and setting can only be carried out with the button of this unit.
- Use cables with a thickness of A.W.G.24 (0.2 mm²) or more and a length no more than 1.5 m to connect VCRs.
- It is recommended that you do not connect any more than 10 VCRs together.
- Only one VCR can be specified at the master unit.
- Do not mix operator mode and administrator/installer mode in the same installation.
- Do not connect the VCRs in a loop.
- "TERMINAL SET" in the (OTHERS) menu should always be set to "SET1".
- The VCR operation may not be completely synchronized depending on the VCR statuses, the operating environment and the operation timing. It is recommended that you check the operating statuses and menus after carrying out each operation.

Connection

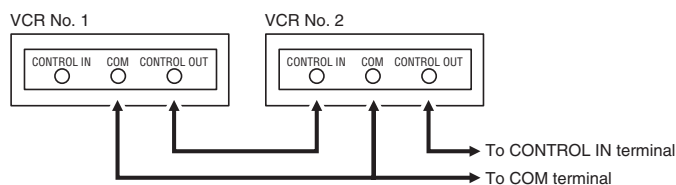

Operator Mode

This mode lets you carry out basic operations (ejecting, recording, stopping, rewinding and changing the recording speed mode).

NOTE:

- This mode will not work correctly unless the VCRs are in the same initial state.
- ① Press the **MENU** button to display the MAIN MENU.
- ② Press the **▼** (or **▲**) button to select the "4.WARNING OUT/CONTR. SET" line, then press the **ENTER** button.
 - *The (WARNING OUT/CONTROL SET) menu appears.*

<WARNING OUT SET>SET UP	
ALARM	Y
NON REC	N
MECHA. PROBLEM	Y
<CONTROL SET>	
EJECT MODE	EJECT1
OPERATION	SLAVE

- ③ Press the **▼** (or **▲**) button until the "OPERATION" setting is highlighted, then press the **ENTER** button.
- ④ Press the **▼** (or **▲**) button to select the desired operation, then press the **ENTER** button.
 - SLAVE The function is restricted to only the VCR being operated.
 - MASTER The function is applied to the VCR being operated and all VCRs that are connected after it.
- When the "OPERATION" is set to "MASTER", "M" lights on the digital display.
- ⑤ Press the **MENU EXIT** button.

SYNCHRONIZATION CONTROL

Setting the Cassette Eject Mode

Operator mode can be used to eject cassettes for all VCRs or for specified VCRs.

- ❶ Follow steps ❶ to ❷ under "Operator Mode".
- ❷ Press the ▼ (or ▲) button until the "EJECT MODE" setting is highlighted, then press the **ENTER** button.
- ❸ Press the ▼ (or ▲) button to select the desired cassette eject mode, then press the **ENTER** button.

EJECT1	The cassette is ejected only if the VCR is not in recording or recording pause mode.
EJECT2	The cassette is ejected only if the VCR is in stop mode.
- ❹ Press the **MENU EXIT** button.

Administrator/Installer Mode

This mode lets you carry out basic operations (ejecting, recording, stopping, rewinding and changing the recording speed mode) and also make menu settings.

NOTES:

- This mode will not work correctly unless the VCRs are in the same initial state.
- Menu settings will not work correctly unless the menu settings for the VCRs are the same. Set the menu settings for each VCR to the initial setting before using this mode to change the settings.
- If a power failure occurs, make the settings again.
- ❶ While holding the **STOP** button, press the **STILL/PAUSE** button for 3 seconds or more on the VCR that is set to be the master VCR.
 - "M" will flash on the digital display.
 - "M" flashes (master) . . . The menu settings can be changed for the VCR being operated and all VCRs that are connected after it.
 - This mode can be used regardless of the "OPERATION" setting in the (WARNING OUT/CONTROL SET) menu.
 - "M" off (slave) The menu settings can be changed for only the VCR being operated.
- To cancel the master mode, press and hold the **STOP** button and then press the **STILL/PAUSE** button.

SETTING FOR RS-485 USE

The RS-485 interface can be used to operate the VCR using a SANYO brand system controller.

NOTES:

- This can only be used when the RS-485 interface board (VZU-40485) is installed.
- Refer to the instruction manual for the VZU-40485 and/or the system controller.

Setting the Address and Data Transfer Speed

- Make this setting without a cassette tape inserted.
- 1 Press the **PLAY** button for 3 seconds or more.
 - "Ad" and the address number appear on the digital display.
 - 2 Press the **▼** (or **▲**) button to set the VCR address (from 000 to 127).
 - The address set appears on the digital display.
 - 3 Press the **ENTER** button.
 - 4 Press the **▼** (or **▲**) button to set the data transfer speed (19200, 2400, 4800, 9600).
 - The data transfer speed set appears on the digital display.
 - 5 When finished, press the **PLAY** button.
 - 6 Move the shorting bar of the RS-485 interface board to change the TERMINATE setting.

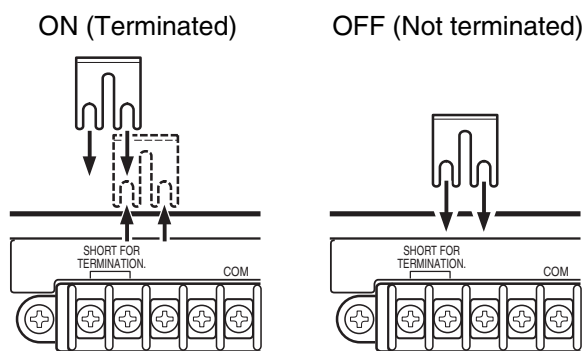

NOTE:

- When the **MENU RESET** button is pressed, the setting appearing on the digital display is reset to the default setting.

Settings when using RS-485

- 1 Press the **MENU** button to display the MAIN MENU.
- 2 Press the **▼** (or **▲**) button to select the "9.OTHERS" line, then press the **ENTER** button.
 - The (OTHERS) menu appears.

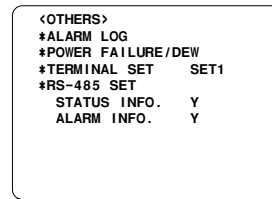

- 3 Press the **▼** (or **▲**) button until the "STATUS INFO." setting is highlighted, then press the **ENTER** button.
- 4 Press the **▼** (or **▲**) button to set the "STATUS INFO." setting, then press the **ENTER** button.
 - Y. The VCR status information is output at the RS-485 connector.
 - N. The status information is not output at the RS-485 connector.
- 5 Press the **▼** (or **▲**) button until the "ALARM INFO." setting is highlighted, then press the **ENTER** button.
- 6 Press the **▼** (or **▲**) button to set the "ALARM INFO." setting, then press the **ENTER** button.
 - Y. The VCR alarm information (alarm recording start and stop) and video loss information are output at the RS-485 connector.
 - N. The VCR alarm information (alarm recording start and stop) and video loss information are not output at the RS-485 connector.
- 7 Press the **MENU EXIT** button.

NOTE:

- When a warning state (non-recording, mechanical problem or clog detection) occurs, the warning state is output from the RS-485 connector. However, non-recording warning states are not output if "NON REC" is set to "N" in the (WARNING OUT/CONTROL SET) menu. In addition, the clog detection warning state is not output if "CLOG DETECT." is set to "N" in the (GENERAL SET) menu.

CHECKING POWER FAILURE, FAILURE DUE TO CONDENSATION AND USAGE DURATION

- ① Press the **MENU** button to display the MAIN MENU.
- ② Press the ▼ (or ▲) button to select the "9.OTHERS" line, then press the **ENTER** button.
 - The (OTHERS) menu appears.

```

<OTHERS>
*ALARM LOG
*POWER FAILURE/DEW
*TERMINAL SET      SET1
    
```

- ③ Press the ▼ (or ▲) button to select the "POWER FAILURE/DEW" line, then press the **ENTER** button.
 - The (POWER FAILURE/DEW/USED TIME) menu appears.

Example

```

<POWER FAILURE>
001 FAILURE 12-25 07:15
    RECOVERY 12-25 07:30

<DEW>
001 FAILURE 12-25 11:00
    RECOVERY 12-25 12:00

<USED TIME>
VIDEO      00003H
POWER      00007H
    
```

POWER FAILURE The number of power failures, and the date and time of the most recent power failure and recovery are displayed.

DEW The number of failures due to condensation, and the date and time of the most recent failure and recovery are displayed.

USED TIME The video heads usage duration and the power on duration are displayed.

- ④ Press the **MENU EXIT** button.

NOTE:

- If the **MENU RESET** button is pressed while the "POWER FAILURE" and "DEW" data is displayed, the data is erased. The "USED TIME" data cannot be reset. "P" will be erased from the digital display.

OUTPUT TERMINALS

TAPE END OUT Terminal

- During recording, when the end of the tape is reached or when the tape counter reading indicates 8 hours, the output becomes 0 V (Low). During autorepeat recording, the output becomes 0 V (Low) for about 2 seconds only.
- To reset the output, press the **STOP** or **EJECT** button.

TAPE END OUT Terminal Output Setting

- 1 Press the **MENU** button to display the MAIN MENU.
- 2 Press the **▼** (or **▲**) button to select the "5.ALARM/SERIES REC SET" line, then press the **ENTER** button.

○ The (ALARM/SERIES REC SET) menu appears.

<ALARM/SERIES REC SET>	
*ALARM SET	
MODE	Y1
SPEED	8H
DURATION	20S
*1 SHOT SET	
FIELD	1
INTERVAL	1M
*SERIES REC	N
*TAPE END OUT	8:00

- 3 Press the **▼** (or **▲**) button until the "TAPE END OUT" setting is highlighted, then press the **ENTER** button.
- 4 Press the **▼** (or **▲**) button to select the desired mode, then press the **ENTER** button.
 - 8:00 (6:00) . . . The output becomes 0 V (Low) when the tape counter reaches "8:00:00 (or 6:00:00)" and/or when the tape reaches the end.
 - END The output becomes 0 V (Low) when the tape reaches the end.

NOTES:

- If the "TAPE" in the (GENERAL SET) menu is set to "T-120", "6:00" will be indicated instead of "8:00".
 - If the "SERIES REC" is set to "Y" in the (ALARM/SERIES REC SET) menu, the output becomes 0 V (Low) for about 2 seconds when the counter reaches "8:00:00", even if the "TAPE END OUT" is set to "END".
 - If the "SERIES REC" is set to "Y" in the (ALARM/SERIES REC SET) menu, the output becomes 0 V (Low) until 5 minutes have passed after the tape reaches the end.
- 5 Press the **MENU EXIT** button.

COM Terminal

- Common GND (ground) terminal when connecting other terminals to external devices.

TIMER OUT terminal

- During timer recording, the output becomes 0 V.
- During timer recording stand-by mode, the output is 5 V (High).

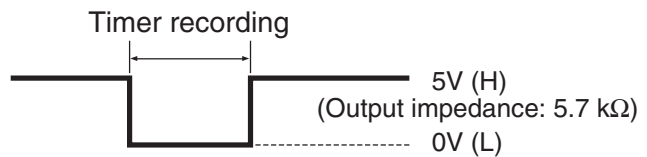

OUTPUT TERMINALS

SW OUT Terminal

When recording, a pulse signal is output at the **SW OUT** terminal.

This terminal is usually connected to the switch input (SW IN) of devices like a camera switcher unit, or a quad compressor.

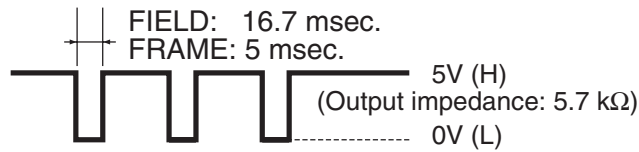

SW OUT Terminal Output Setting

- ① Press the **MENU** button to display the MAIN MENU.
- ② Press the ▼ (or ▲) button to select the "2.DISPLAY/SW OUT SET" line, then press the **ENTER** button.
 - The (DISPLAY/SW OUT SET) menu appears.

<DISPLAY SET>	SET UP
DATE	Y
TIME	Y
SPEED	Y
ALARM COUNT	Y
<SW OUT SET>	
TIMING	FIELD
FIELD	1
8H MODE	Y

- ③ Press the ▼ (or ▲) button until the "TIMING" setting is highlighted, then press the **ENTER** button.
- ④ Press the ▼ (or ▲) button to select the desired output timing, then press the **ENTER** button.
 - FIELD. 1 pulse is output after each set number of fields.
 - FRAME 1 pulse is output after each set number of frames.
- ⑤ Press the **ENTER** button.
- ⑥ Press the ▼ (or ▲) button to select the desired pulse signal interval (1, 2, 3, 4, 5, 10, 30 or 60), then press the **ENTER** button.
 - If "TIMING" is set to FRAME (see step ④), "FRAME" will be indicated instead of "FIELD".
- ⑦ Press the **ENTER** button.

- ⑧ Press the ▼ (or ▲) button to select the desired "8H MODE (or 6H MODE)" mode, then press the **ENTER** button.
 - If the "TAPE" in the (GENERAL SET) menu is set to "T-120", "6H" will be indicated instead of "8H".
 - Y. When recording in 8-hour (or 6-hour) mode, a pulse signal is output.
 - N When recording in 8-hour (or 6-hour) mode, a pulse signal is not output.
- ⑨ Press the **MENU EXIT** button.

OUTPUT TERMINALS

WARNING OUT Terminal

- The **WARNING OUT** terminal output becomes 0 V (Low) in accordance with the (WARNING OUT/CONTROL SET) menu.

WARNING OUT Terminal Output Setting

- 1 Press the **MENU** button to display the MAIN MENU.
- 2 Press the ▼ (or ▲) button to select the "4.WARNING OUT/CONTR. SET" line, then press the **ENTER** button.
 - The (WARNING OUT/CONTROL SET) menu appears.

<WARNING OUT SET>SET UP	
ALARM	Y
NON REC	N
MECHA. PROBLEM	Y
VIDEO LOSS	Y
CLOG DETECT.	Y
<CONTROL SET>	
EJECT MODE	EJECT1
OPERATION	SLAVE

- 3 Press the **ENTER** button.
- 4 Press the ▼ (or ▲) button to select the desired mode, then press the **ENTER** button.
 - SET UP Set each item
 - ALL Y To set all items to "Y"
 - ALL N To set all items to "N"
 - If using the "SET UP" setting, continue with steps 5 to 7.
- 5 Press the ▼ (or ▲) button until the item for warning output is highlighted, then press the **ENTER** button.
- 6 Press the ▼ (or ▲) button to set "Y" (warning is given) or "N" (warning is not given), then press the **ENTER** button.

ALARM.	The output becomes 0 V and "A" appears on the digital display during alarm recording
NON REC	The output becomes 0 V and "N" appears on the digital display if the VCR enters a mode other than recording (i.e. recording pause, stop mode, etc.) during recording
MECHA. PROBLEM . . .	The output becomes 0 V and "M" appears on the digital display when the tape stops or other problem with the internal mechanism

VIDEO LOSS The output becomes 0 V and "V" appears on the digital display when there is no video signal

CLOG DETECT. The output becomes 0 V and "C" appears on the digital display when the heads are dirty and the recording quality deteriorates

- 7 Repeat steps 5 and 6 when setting other items.
- 8 When finished, press the **MENU EXIT** button.

NOTES:

- The "VIDEO LOSS" line does not appear if "VIDEO LOSS" is set to "N" in the (GENERAL SET) menu.
- The "CLOG DETECT." line does not appear if "CLOG DETECT." is set to "N" in the (GENERAL SET) menu.
- Displays on the digital display take precedence over other displays.
- Canceling warning displays and output.
 - Press the **STOP** button once.
 - The warning display disappears from the digital display.
 - Press the **STOP** button once more.
 - If "MECHA. PROBLEM" or "CLOG DETECT." warnings are being output, then output stops.
- If the "NON REC", "VIDEO LOSS" or "ALARM" warning is being output, the condition immediately before the warning output is restored and the output stops.
- If the system has shut down because of a "MECHA. PROBLEM" warning, the output is canceled when the **ALL RESET** button is pressed.

OUTPUT TERMINALS

REMOTE Jack

Remote control of the VCR is possible by connecting a remote controller with a circuit such as indicated below, to the **REMOTE** jack.

NOTES:

- Use a 3.5 mm mini-jack type plug.
- The connection should be done using a shielded cable no more than 5 meters long.
- The functions not available on the VCR will not operate.
- You can use a VA-RMN01 Remote Control Unit (sold separately) to control the VCR remotely. The functions not available on the VCR will not operate.

Remote control circuit

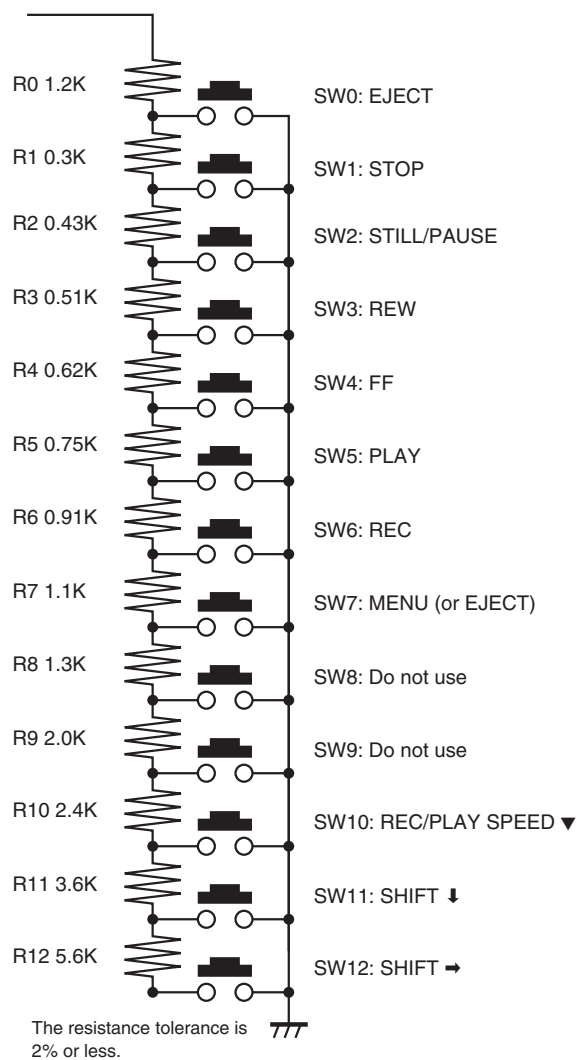

Remote control setting

The remote control switch 7 (see illustration at left) can be set to either eject the tape or access the menus.

- 1 Press the **MENU** button to display the MAIN MENU.
- 2 Press the ▼ (or ▲) button to select the "3.GENERAL SET" line, then press the **ENTER** button.
 - The (GENERAL SET) menu appears.

<GENERAL SET>	
TAPE IN MODE	STOP
TAPE END MODE	REW
CLOCK ADJUST	01:00
THREAD CHECK	N
VIDEO LOSS	N
CLOG DETECT.	N
REMOTE	MENU
VIDEO	COLOR
VERTICAL SYNC	Y
TAPE	T-160

- 3 Press the ▼ (or ▲) button until the "REMOTE" setting is highlighted, then press the **ENTER** button.
- 4 Press the ▼ (or ▲) button to select the desired switch mode, then press the **ENTER** button.
 - MENU Switch operates as an **MENU** button
 - EJECT Switch operates as an **EJECT** button
- 5 Press the **MENU EXIT** button.

MAINTENANCE

Daily Inspection

The following daily inspections are recommended in order to assure long-term and trouble-free operation of the unit.

The daily inspections are particularly important if using autorepeat recording.

Inspection Procedure

- ❶ Turn on the power to the VCR, camera, TV monitor and other connected devices.
- ❷ Check that the image received on the TV monitor is correct.
- ❸ Check that the on-screen display of the date and time is correct.
- ❹ To check the recording condition of the previous day, rewind the recorded tape a few seconds.
- ❺ Press the **PLAY** button and check that the playback image is correct.
- ❻ Check that the recorded date and time are correct.

NOTES:

- If the security lock is engaged, it has to be released before proceeding to the inspection.
- If any problem is discovered during the inspection, unplug the power cord then consult your dealer.

Periodic Inspection

Periodic inspection and maintenance should be referred to your dealer.

If there is noise in the playback picture, and it cannot be corrected using the tracking control, it may indicate that the video heads need cleaning.

Soiling is unlikely, thanks to the automatic head cleaning function, but due to factors such as the use of poor quality tape and the usage environment the heads could become dirty in a short time.

The video heads should be inspected every 1,000 hours of use to determine if they need to be replaced.

The video heads usage can be checked using the (POWER FAILURE/DEW/USED TIME) menu.

Cabinet Cleaning

Clean the outside of the cabinet with a clean, soft cloth, moistened with lukewarm water and wrung dry.

DO NOT USE SOLVENTS OR OTHER TYPES OF CLEANERS. THESE CHEMICALS CAN CRACK OR DISCOLOR THE CABINET.

About the Backup Battery

The date and time settings are maintained for up to 30 days by a rechargeable lithium battery that is fully charged after the VCR has been connected to a power source for 48 hours or more.

Depending on the battery usage it may become necessary to change it. For replacement and disposal of the old battery, please contact your dealer.

After the battery has been replaced, press the **ALL RESET** button, then enter all the time, date, etc. settings as required.

Automatic Head Cleaning Function

- Whenever a video cassette is loaded or ejected, the video heads are automatically cleaned.
- During autorepeat recording, the video heads are automatically cleaned when the tape reaches the end.

MAINTENANCE

Maintaining and Checking The Mechanism

To maintain the VCR functions and features working properly, and to avoid damages or dirt on the tape, it is recommended to follow the maintenance points and periodicity indicated below.

For detailed information, please contact your dealer.

Maintenance Table

○ : Cleaning ⊙ : Confirmation △ : Lubrication □ : Change

	PARTS	2000H	4000H	6000H	8000H	NOTES
Tape Path System	ASSY, BRAKE BAND	⊙	□	⊙	□	
	ASSY, LEVER BT (tape guide)	○	○	○	○	
	FULL ERASE HEAD	○	○	○	□	
	ASSY, ROLLER CLEANER	⊙	□	⊙	□	
	ASSY, GUIDE ROLLER	○	○	○	○	
	ASSY, MOUNTING INCLNE S	○	○	○	□	
	ASSY, MOUNTING INCLNE T	○	○	○	□	
	ACE HEAD	○	○	○	□	
	ASSY, LEVER PINCH ROLLER	○	□	○	□	
	MOUNTING, LIFT PINCH				□	
	CAM, LIFT PINCH				□	
	GEAR, CAM PINCH				□	
	EARTH CHIP CYLINDER				□	
	COMPL, CYLINDER	○	○(□)	○	○(□)	
ASSY, CYLINDER UPPER	○(□)	○(□)	○(□)	○(□)		
Reel Drive System	ASSY, REEL SUPPLY	○△	○△	○△	○△	
	ASSY, REEL TAKEUP	○△	○△	○△	○△	
	GEAR, REEL S	△	△	△	△	
	GEAR, REEL T	△	△	△	△	
	PULLEY, REEL	△	△	△	△	
	SPECIAL, WASHER 2.4 X 6 X 0.25		⊙		⊙	
	COMPL, MOUNTING CLUTCH	△	□	△	□	
	BELT, REEL	⊙	□		□	
	MOTOR, CAPSTAN	○	⊙(□)	⊙(□)	□	
	ASSY, GEAR FRICTION	△	△□	△	△□	
	Brake	ASSY, BRAKE S	⊙	⊙	⊙	⊙
ASSY, BRAKE T		⊙	⊙	⊙	⊙	
ASSY, BRAKE CAPSTAN		⊙	⊙	⊙	⊙	
ASSY, BRAKE SOFT T			⊙		□	
Loading Drive System	ASSY, LOADING MOTOR		⊙		□	
	DAMPER				□	
	COMPL, GEAR WORM		⊙		□	
	CAM, MAIN				□	
	SPECIAL WASHER 3.6 X 0.5		⊙		□	
	GEAR, WHEEL 1				□	
	GEAR, WHEEL 2		⊙		□	
	GEAR RELAY PINCH OPT				□	
	SLIDE, CRECENT		⊙		□	
	GEAR, LOAD S		⊙		□	
	GEAR, RACK FRONT		⊙		□	
GEAR, RACK START		⊙		□		
GEAR, PINON		⊙		□		
Performance Check	BACK TENSION TORQUE	⊙	⊙	⊙	⊙	PB BACK TENSION TORQUE 25~50g·cm
	FWD, REW TORQUE	⊙	⊙	⊙	⊙	FWD, REW TORQUE ≥ 600g·cm
	PLAY TORQUE	⊙	⊙	⊙	⊙	PLAY 55 ~ 110g·cm
	REV TORQUE	⊙	⊙	⊙	⊙	REV 100 ~ 210g·cm

NOTES:

- This table shows the maintenance for up to 8000 hours. After this, repeat from the start of the table.
- For places with symbols such as ⊙ (□) and ○ (□), carry out checking and cleaning, and replace if necessary.
- This periodic maintenance check table changes considerably according to the using conditions and environment.
- Refer to the (POWER FAILURE/DEW/USED TIME) menu for the length of time the unit has been used.
- As the life of parts may be shortened if foreign particles and dusts remain accumulated on the tape guides and rotating and contacting portions, clean if dirty.
- Dusts and other foreign particles on the tape guides may also shorten the tape life and lower picture quality, therefore clean thoroughly.

TROUBLESHOOTING GUIDE

If the unit does not operate normally when you follow the instructions indicated in the manual, please refer to the table below.

SYMPTOM	POSSIBLE CAUSE	CORRECTIVE ACTION
No power	The power cord is not connected	Connect the power cord
No image displayed on the TV monitor	The connections are not correct	Check that all connections are correct
	The power to the camera and/or TV monitor is not turned on	Turn all connected devices power on
The buttons do not respond	A cassette tape is not loaded	Load a cassette and turn the power on
	All functions are suspended due to condensation	Wait for the "dd dd" indicator to go off
	Alarm recording	Wait for the alarm recording to end
	Unit in menu mode	Press the MENU EXIT button.
Recording is not possible (the tape is ejected)	The security lock is engaged	Cancel the security lock
	The loaded cassette has no erasure-prevention tab	Load a cassette tape with an erasure-prevention tab or cover the tab hole with adhesive tape
Recording is not possible (Tape rewinds)	"Y" is selected for the tape management	Normally. Refer to "TAPE MANAGEMENT" on page 17.
Autorepeat recording is not possible	"AL" appears on the digital display	Display (ALARM LOG) menu, then press the MENU RESET button to turn off the "AL" indicator
Timer recording is not possible	The date and time are not set correctly	Set the date and time correctly
	The unit is not set to timer recording stand-by mode	Press the TIMER button to display "□" on the digital display
	"N" is selected for the timer recordings	Be sure to select "Y" for the programmed timer recordings
Alarm recording is not possible	"OFF" appears on the digital display	Press the EJECT , STOP , FF , REW or PLAY button to turn the indicator off
Noise in the playback picture	The video heads need cleaning	Clean the video heads
The date and time are not recorded	Display mode not set.	Set the ON SCREEN switch to the "ON" position.
"●" flashes.	The heads are dirty (see page 22).	Clean the heads.
The cassette tape cannot be ejected	Problem with the system	Unplug the power cord then plug it back in
The cassette is ejected a few seconds after it has been inserted	The tape is not threaded correctly	Try inserting the cassette one more time or using a new cassette. If it is ejected again, please consult your dealer.

After a Power Failure

If the recording speed is reset to 8-hour mode after a power failure, it is due to insufficient backup battery charge. This is not a malfunction.

System Down

If the unit does not function at all, try the following.

- ❶ Unplug the power cord then plug it back in.
- ❷ Reset the memory. (Press the **ALL RESET** button. Under normal conditions, do not touch the **ALL RESET** button.)
The time and date will be reset, and the security lock will be canceled.
- ❸ If the problem is not corrected after performing steps ❶ and ❷ a few times, consult your dealer.

SPECIFICATIONS

General Specifications

Video head system	Dual-azimuth 4-head rotating helical scanning system: Dual azimuth 2-head for record and standard playback Dual azimuth 4-head for forward picture search, reverse picture search and still mode
Audio recording	In 8-, 24- and 40-hour modes (when using T-160 tape) In 6-, 18- and 30-hour modes (when using T-120 tape)
Tape speed	11.12 mm /sec (8-hour mode)
Specified video cassette tape	VHS 1/2 inch video cassette tape
Recording/playback time	8, 24 and 40 hours (when using T-160 tape) 6, 18 and 30 hours (when using T-120 tape)
Fast forward/rewind time	approximately 2 minutes 35 seconds (when using T-160 tape) approximately 2 minutes (when using T-120 tape)
Television system	NTSC color TV system

Video

Recording method	Luminance signal: FM recording Chrominance signal: Down-converted direct recording
Video input	1 V(p-p), BNC, 75 Ω , unbalanced
Video output	1 V(p-p), BNC, 75 Ω , unbalanced
Horizontal resolution	Black & white mode 350 line or more Color mode 300 line or more

Audio

Input	-8 dBs, RCA pin jack, 27 k Ω , unbalanced
Output	-8 dBs, RCA pin jack, 600 Ω , unbalanced

Connectors

Alarm (1 shot) input	No voltage, make-contact switch input (Low input 100ms or more, Normally 5 V)
Control input	Key code (pulse signal) (Normally 5 V)
Series input	No voltage, make-contact switch input (Low input 1s or more, Normally 5 V)
Ext timer (alarm reset) input	No voltage, make-contact switch input (Low input 100ms or more, Normally 5 V)
Common	0 V (GND)
Warning output	Open collector Max. 500 mA (Active Low 0 V, Normally open)
Control output	Key code (pulse signal) (Normally 5 V)
Tape end output	Open collector Max. 50 mA (Active Low 0 V, Normally open)
Timer output	DC 5 V, 5.7k Ω , (Low output)
Switch output	Pulse signal (Normally 5 V)
Remote control input	3.5 mm mini jack
DC 12-24 V "+" input (SRT-4040DC only)	DC 12 to 24 V
DC 12-24 V "-" input (SRT-4040DC only)	DC 0 V

SPECIFICATIONS

Other Specifications

Operating temperature range	5°C to 40°C (41°F to 104°F)
Operating humidity range	80% or less
Power requirements (SRT-4040 only)	120V AC, 60Hz
Power requirements (SRT-4040DC only)	12–24V DC
Power consumption (SRT-4040 only)	14 W
Power consumption (SRT-4040DC only)	16 W
Dimensions (W x H x D)	240 mm x 96.5 mm x 335 mm (9.45" x 3.8" x 13.19")
Weight	approximately 3.6 kg

Connectors (When the "TERMINAL SET" is set to "SET2")

NOTES:

- The terminal names and signals are different from the usual setting.
- Names in brackets apply to terminals on the rear panel.

Clock set input (CONTROL IN)	No voltage, make-contact switch input (Low input 100ms or more, Normally 5 V)
Clock set output (CONTROL OUT)	DC 5 V, 5.7kΩ, (Low output)
Eject input (SERIES IN)	No voltage, make-contact switch input (Low input 100ms or more, Normally 5 V)
Eject output (TIMER OUT)	DC 5 V, 5.7kΩ, (Low output)

NOTE: The specifications and external appearance of this unit are subject to change without notice.

**SANYO INDUSTRIAL
VCR WARRANTY**

OBLIGATIONS

In order to obtain warranty service, the product must be delivered to and picked up from an Authorized Sanyo Service Center at the user's expense, unless specifically stated otherwise in this warranty. The names and addresses of Authorized Sanyo Service Centers may be obtained by calling the toll-free number listed below.

For product operation, authorized service center referral, service assistance or problem resolution, call

**CUSTOMER INFORMATION 1-800-421-5013
Weekdays 8:30 AM – 5:00 PM Pacific Time**

For accessories and/or parts, call

**PARTS ORDER INFORMATION 1-800-726-9662
Weekdays 8:30 AM – 5:00 PM Pacific Time**

THIS WARRANTY IS VALID ONLY ON SANYO PRODUCTS PURCHASED OR RENTED IN THE UNITED STATES OF AMERICA, EXCLUDING ALL U.S. TERRITORIES AND PROTECTORATES. THIS WARRANTY APPLIES ONLY TO THE ORIGINAL RETAIL PURCHASER OR END-USER. THE ORIGINAL DATED BILL OF SALE, SALES SLIP OR RENTAL AGREEMENT MUST BE SUBMITTED TO THE AUTHORIZED SANYO SERVICE CENTER AT THE TIME WARRANTY SERVICE IS REQUESTED.

Subject to the OBLIGATIONS above and EXCLUSIONS below, SANYO Fisher Company warrants this SANYO product against defects in materials and workmanship for the periods specified below. SFC will repair or replace (at its option) the product and any of its parts which fail to conform to this warranty. The warranty period commences on the date the product was first purchased or rented at retail.

LABOR	PARTS	VIDEO HEADS
1 YEAR	1 YEAR	90 DAYS

EXCLUSIONS

This warranty does not cover (A) the adjustment of customer-operated controls as explained in the appropriate model's instruction manual, or (B) the repair of any product whose serial number has been altered, defaced or removed.

This warranty shall not apply to the cabinet or cosmetic parts, batteries or routine maintenance.

This warranty does not apply to uncrating, setup, installation, removal of the product for repair or reinstallation of the product after repair.

This warranty does not apply to repairs or replacements necessitated by any cause beyond the control of SFC including, but not limited to, any malfunction, defect or failure caused by or resulting from unauthorized service or parts, improper maintenance, operation contrary to furnished instructions, shipping or transit accidents, modification or repair by the user, abuse, misuse, neglect, accident, incorrect power line voltage, fire, flood or other Acts of God, or normal wear and tear.

The foregoing is in lieu of all other expressed warranties and SFC does not assume or authorize any party to assume for it any other obligation or liability.

SFC DISCLAIMS ALL OTHER WARRANTIES EXPRESS OR IMPLIED, WITH REGARD TO THIS PRODUCT (INCLUDING THE WARRANTIES OF MERCHANTABILITY AND FITNESS). IN NO EVENT SHALL SFC BE LIABLE FOR ANY SPECIAL, INCIDENTAL OR CONSEQUENTIAL DAMAGES ARISING FROM THE OWNERSHIP OR USE OF THIS PRODUCT OR FOR ANY DELAY IN THE PERFORMANCE OF ITS OBLIGATIONS UNDER THIS WARRANTY DUE TO CAUSES BEYOND ITS CONTROL. SFC'S LIABILITY FOR ANY AND ALL LOSSES AND DAMAGES RESULTING FROM ANY CAUSE WHATSOEVER, ARISING OUT OF OR IN CONNECTION WITH THE SALE, USE OR OWNERSHIP OF THIS PRODUCT INCLUDING WARRANTOR'S NEGLIGENCE, ALLEGED DAMAGED OR DEFECTIVE GOODS, WHETHER SUCH DEFECTS ARE DISCOVERABLE OR LATENT, SHALL IN NO EVENT EXCEED THE PURCHASE PRICE OF THE PRODUCT.

ATTENTION

For your protection in the event of theft or loss of this product, please fill in the information below for you own personal records.

Model No. _____ **Serial No.** _____
(Located on back or bottom side of unit.)

Date of Purchase _____ **Purchase Price** _____

Where Purchased _____

Free Manuals Download Website

<http://myh66.com>

<http://usermanuals.us>

<http://www.somanuals.com>

<http://www.4manuals.cc>

<http://www.manual-lib.com>

<http://www.404manual.com>

<http://www.luxmanual.com>

<http://aubethermostatmanual.com>

Golf course search by state

<http://golfingnear.com>

Email search by domain

<http://emailbydomain.com>

Auto manuals search

<http://auto.somanuals.com>

TV manuals search

<http://tv.somanuals.com>