



INSTRUCTION MANUAL

TLS-1960P TLS-9924P

Time Lapse Video Cassette Recorder

English

Time Lapse-Videorecorder

Deutsch

Magnétoscope time lapse à cassette

Français

Videograbador en lapsos de tiempo

Español

Videoregistratore a cassette, a fotogrammi differenziati

Italiano

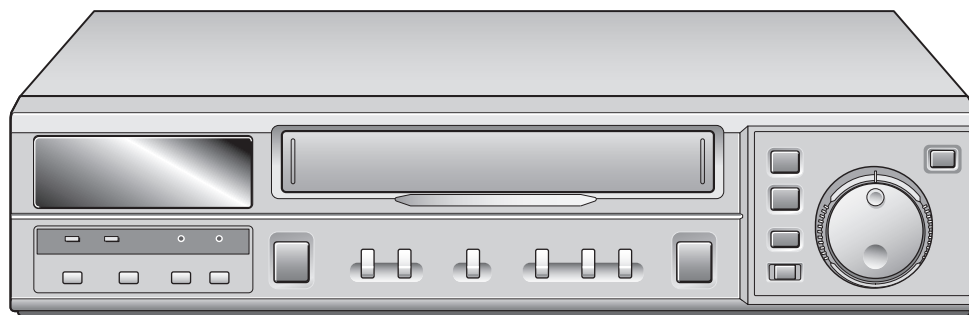

Please read this manual carefully before connecting your VCR and operating it for the first time.
Be sure to read carefully and follow all the PRECAUTIONS on page 1 and 2.
Keep the manual in a safe place for future reference.

PRECAUTIONS

WARNING: DO NOT EXPOSE THE VCR TO DRIPPING OR SPLASHING, AND NEVER PUT ANY OBJECTS FILLED WITH LIQUIDS, SUCH AS VASES, ON TOP OF THE VCR.

To avoid electrical shock, do not open the cabinet.

Refer servicing to qualified personnel only.

If the power supply cord (AC power cord) of this appliance is damaged, it must be replaced. Return to a SANYO Authorised Service Centre for replacement of the cord.

CAUTION: Do not put your hand or other objects in the cassette loading slot because of risk of injury or accident. Be sure to keep small children away from the VCR.

IMPORTANT NOTE (U. K. Only)

The wires in the mains lead are coloured according to the following code:

Blue: Neutral

Brown: Live

If the colours of the wires in the mains lead of this apparatus do not correspond with the colour markings identifying the terminals in your plug, proceed as follows:

- The wire which is coloured blue must be connected to the terminal which is marked with the letter **N** or coloured blue or black.
- The wire which is coloured brown must be connected to the terminal which is marked with the letter **L** or coloured brown or red.
- Do not connect either wire to the **Earth** terminal.

Bij dit produkt zijn batterijen geleverd. Wanneer deze leeg zijn, moet u ze niet weggooien maar inleveren als KCA.



CAUTION

Danger of explosion if battery is incorrectly replaced.

Replace only with the same or equivalent type recommended by the manufacturer.

Discard used batteries according to the manufacturer's instructions.

ADVARSEL!

Lithiumbatteri-Eksplosionsfare ved fejlagtig håndtering.

Udskiftning må kun ske med batteri af samme fabrikat og type.

Levér det brugte batteri tilbage til leverandøren.

ADVARSEL

Eksplosjonsfare ved feilaktig skifte av batteri.

Benytt samme batteritype eller en tilsvarende type andefalt av apparatfabrikanten.

Brukte batterier kasseres i henhold til fabrikantens instruksjoner.

VARNING

Explosionsfara vid felaktigt batteribyte.

Använd samma batterityp eller en ekvivalent typ som rekommenderas av apparattillverkaren.

Kassera använt batteri enligt fabrikantens instruktion.

VAROITUS

Paristo voi räjähtää jos se on virheellisesti asennettu.

Vaihda paristo ainoastaan laitevalmistajan suosittelemaan tyyppiin.

Hävitätä käytetty paristo valmistajan ohjeiden mukaisesti.

PRECAUTIONS

Location

For safe operation and satisfactory performance of your VCR, keep the following in mind when selecting a place for its installation:

- Shield it from direct sunlight and keep it away from sources of intense heat.
- Avoid dusty or humid places.
- Avoid places with insufficient ventilation for proper heat dissipation. Do not block the ventilation holes of the VCR. Do not place the unit on a carpet because this will block the ventilation holes.
- Install the VCR in a horizontal position only.
- Avoid locations subject to strong vibrations.
- Avoid moving the VCR between cold and hot locations (see "Moisture Condensation Problems", this page).
- Do not place the VCR directly on top of the TV, as this may cause playback or recording problems.

Avoiding Electrical Shock and Fire

- Do not handle the power cord with wet hands.
- Do not pull on the power cord when disconnecting it from an AC wall outlet. Grasp it by the plug.
- If any liquid is spilled on the VCR, unplug the power cord immediately and have the unit inspected at a factory-authorized service centre.
- Do not place anything directly on top of this VCR.

Moisture Condensation Problems

Cause:

When the VCR is first installed, moved from a cold area to a warm area or placed in a location with high humidity, dew (moisture) may form in the unit. The Dew indicator (d d d d) blinks. If you operate the VCR with dew inside, damage may result.

Prevention:

- 1 Do not operate the VCR for approximately 2 hours.

When the VCR reaches room temperature, the Dew indicator (d d d d) will turn off and the VCR will be ready for operation.

Power on/stand-by mode

The power on/stand-by mode is selected by pressing the **STANDBY/ON** button.

VCR display

Stand-by mode



Power on mode



"Stand-by mode" is the condition in which only the time is displayed.

Do not forget that even in the stand-by mode there is an electrical voltage inside the VCR as long as it is connected to a wall socket.

Disconnect the power cord from the wall socket if the VCR is not to be used for a long time.

CONTENTS

PRECAUTIONS	1
FEATURES.....	3
ACCESSORIES	3
LOCATIONS OF CONTROLS AND INDICATORS	4
CONNECTIONS	8
ON-SCREEN MENU.....	9
SETTING THE LANGUAGE AND CLOCK.....	11
SUPERIMPOSE DISPLAY.....	13
VIDEO CASSETTE TAPES	14
TAPE MANAGEMENT	16
NORMAL RECORDING.....	19
AUTOREPEAT RECORDING	23
ALARM RECORDING	24
PROGRAMME TIMER RECORDING	27
RECORDING USING AN EXTERNAL TIMER INPUT .	31
SERIES RECORDING	32
SINGLE IMAGE RECORDING.....	33
NORMAL PLAYBACK	34
SPECIAL PLAYBACK	35
DAY/TIME SEARCH.....	37
TAPE COUNTER	37
SECURITY LOCK.....	38
CLOCK ADJUSTMENT	39
SELECTING INPUT AND OUTPUT TERMINALS	39
SETTING THE CASSETTE EJECT MODE	40
SYNCHRONIZATION CONTROL	41
SETTING FOR RS-485 OR RS-232C USE	43
CHECKING POWER FAILURE, FAILURE DUE TO CONDENSATION AND USAGE DURATION	44
OUTPUT TERMINALS.....	45
HEAD SWITCHING FUNCTION.....	49
MAINTENANCE	50
TROUBLESHOOTING GUIDE	52
SPECIFICATIONS	53

FEATURES

- Tape management function
- JOG/SHUTTLE operation
- Clog detection
- High-speed Fast Forward/Rewind
- Field recording/playback
- Audio recording is available in 3-, 12- and 24-hour modes (E-180)
- Autorepeat recording
- Series recording function
- Alarm recording function
- Single image recording function
- On-screen mode setting
- Integrated time date generator
- Day/Time search function
- Alarm scan/search function
- Forward/Reverse field advance function
- 30-day memory backup
- Security lock
- Recording check function
- Automatic head cleaning function
- Thread check function
- Head switching function
- Synchronization control function

TLS-1960P only

- 3, 12, 24, 48, 72, 96, 120, 168, 240, 360, 480, 720 and 960-hour mode recording (E-180)
- AC or DC power operation.

TLS-9924P only

- 3, 12 and 24-hour mode recording (E-180)

When using the RS-485/232C interface board (VZU-485/232C), the VCR can be controlled from a computer or a system controller.

ACCESSORIES

- ① Power cord
- ② Holder

LOCATIONS OF CONTROLS AND INDICATORS

Front Panel

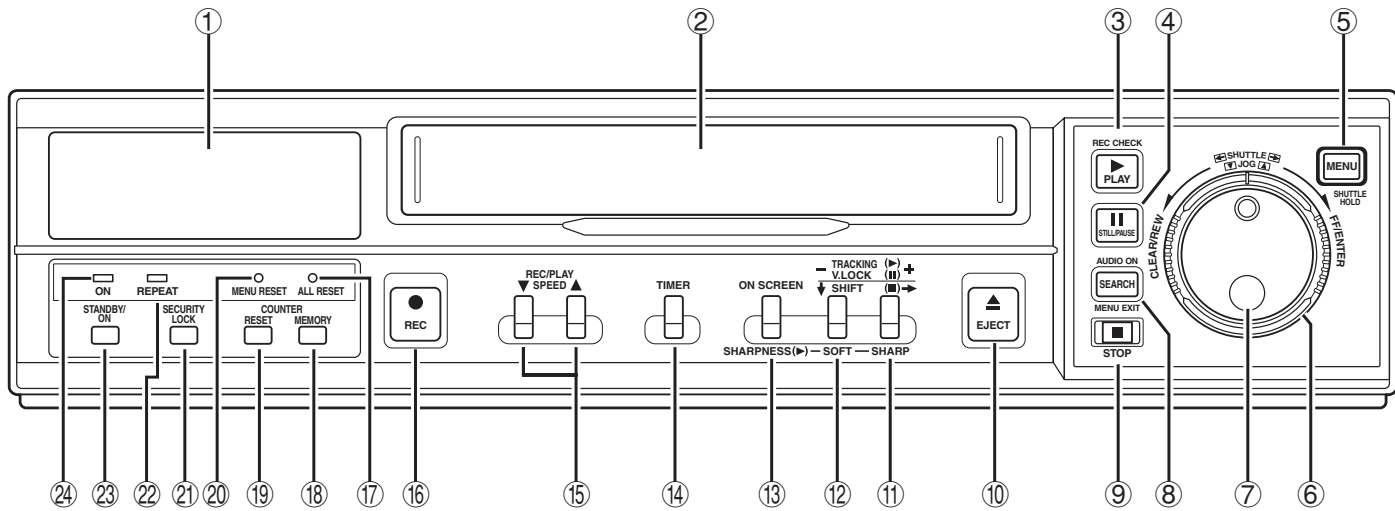

- | | |
|---|--|
| <p>① Digital display panel</p> <p>② Cassette loading slot</p> <p>③ PLAY button
REC CHECK button</p> <p>④ STILL/PAUSE button</p> <p>⑤ MENU button
SHUTTLE HOLD button</p> <p>⑥ SHUTTLE ring</p> <p>⑦ JOG dial</p> <p>⑧ SEARCH button
MENU EXIT button
AUDIO ON button</p> <p>⑨ STOP button</p> <p>⑩ EJECT button</p> <p>⑪ TRACKING + button
V. LOCK + button
SHIFT → button
SHARP button</p> <p>⑫ TRACKING - button
V. LOCK - button
SHIFT ↓ button
SOFT button</p> <p>⑬ ON SCREEN button
SHARPNESS button</p> | <p>⑭ TIMER button</p> <p>⑮ REC/PLAY SPEED ▲, ▼ (decrease or increase recording/playback speed mode) button</p> <p>⑯ REC (record) button</p> <p>⑰ ALL RESET button</p> <p>⑱ COUNTER MEMORY button</p> <p>⑲ COUNTER RESET button</p> <p>⑳ MENU RESET button</p> <p>㉑ SECURITY LOCK button</p> <p>㉒ REPEAT (autorepeat recording) indicator</p> <p>㉓ STANDBY/ON button</p> <p>㉔ ON (power on) indicator</p> <p>NOTE:</p> <ul style="list-style-type: none"> ● Buttons ⑪, ⑫ and ⑮ are also used for menu setting. |
|---|--|

LOCATIONS OF CONTROLS AND INDICATORS

Digital Display

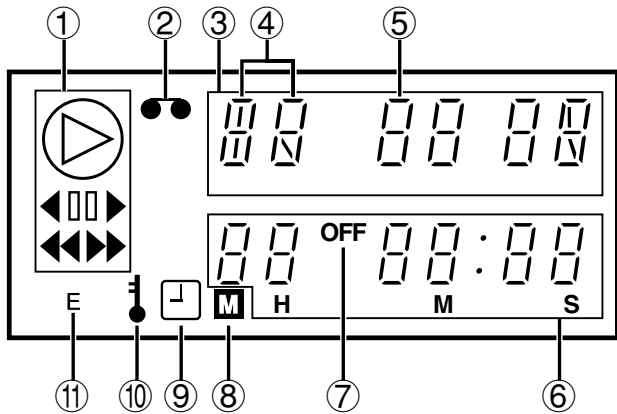

① Operation Indicators

- They display the actual operation mode.

Operation Mode	Indicator
Record (REC)	○
Record pause (REC PAUSE)	○ + [stop icon]
Playback (PLAY)	▷
Still image (STILL)	▷ + [stop icon]
Fast forward (FF)	▶▶
Rewind (REW)	◀◀
Forward picture search	▷ + ▶▶
Reverse picture search	▷ + ◀◀
Reverse playback	▷ + [stop icon]
Forward field advance	▷ + [stop icon] + ▶
Reverse field advance	▷ + [stop icon] + ◀

- Clog detection indicator 

Flashes when the recording quality deteriorates due to dirty VCR heads.

② Cassette indicator

- Lights when a cassette is loaded.

③ Mode display

- Warning display



M flashes: Problem with mechanism.

V flashes: Video loss has occurred.

A flashes: Alarm recording in progress.

When alarm recording finishes, AL lights at ④.

If you press the **STOP** button during alarm recording, AL flashes at ④.

C flashes: Clog detection has occurred.

N flashes: Mode changed to non-recording mode while recording was in progress.

NOTES:

- The warning details appear according to the (WARNING OUT/CONTROL SET) menu setting.
- The warning display has priority over other types of display. (Refer to "WARNING OUT Terminal" on page 47.)
- To cancel the display press the **STOP** button.

- Recording/playback speed mode
- Alarm search setting display

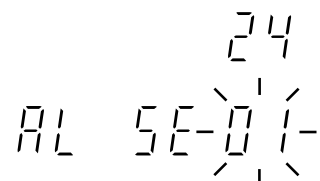

- Alarm scan setting display
- Dew display

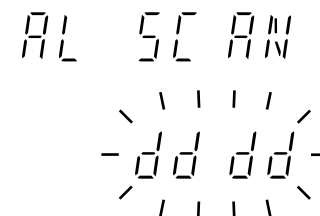

- Picture control setting display



- 4 digit security lock setting display

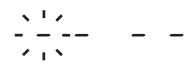

- Tracking control display



LOCATIONS OF CONTROLS AND INDICATORS

[With the RS-485/232C interface board]

- Display when set to RS-485 

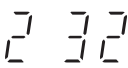
- Display when set to RS-232C 

- Data transfer speed setting display 

- Address setting display (RS-485 only) 

- Address setting display (RS-485 only) 

③, ⑥ Mode display

- Day/Time search setting display



- ⑤ Power failure indicator 
- Lights after a power failure.

NOTE:

- To cancel the "P" display, press the **MENU RESET** button.

- ⑥ Counter display 
- Time display (No tape)

- Linear time counter display (Tape inserted) 

- ⑦ OFF indicator
- Lights when the tape end has been reached after recording.

- ⑧ Counter memory indicator
- Lights when the counter memory function is being used.

- ⑨ Timer Recording indicator
- Lights when in timer recording stand-by mode, or during a timer recording.

- ⑩ Security lock indicator
- Lights when the security lock is engaged.

- ⑪ External input indicator
- Lights when recording using the **EXT TIMER IN** input terminal.



LOCATIONS OF CONTROLS AND INDICATORS

Back Panel (With the RS-485/232C interface board)

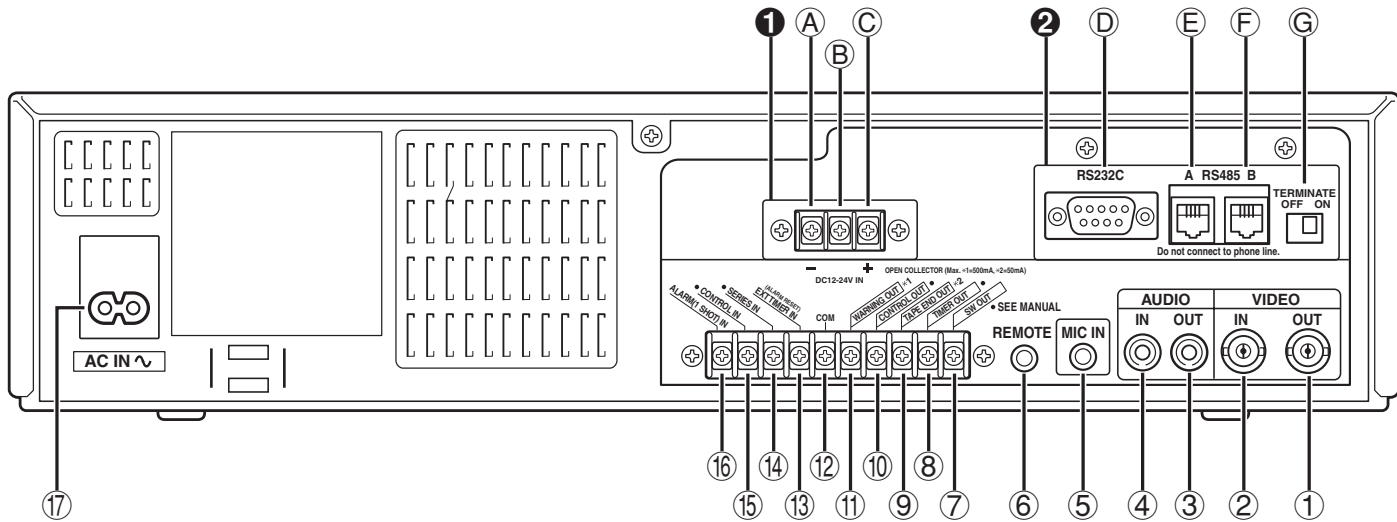

- ① VIDEO OUT (video output) jack
- ② VIDEO IN (video input) jack
- ③ AUDIO OUT (audio output) jack
- ④ AUDIO IN (audio input) jack
- ⑤ MIC IN (microphone input) jack
- ⑥ REMOTE (remote control input) jack
- ⑦ SW OUT (switch output) terminal
- ⑧ TIMER OUT (timer recording output) terminal
- ⑨ TAPE END OUT (tape end output) terminal
- ⑩ CONTROL OUT terminal
- ⑪ WARNING OUT (warning output) terminal
 - Signals are output when an alarm, clog detection, video loss, non-recording or mechanism problem occurs.
- ⑫ COM (common) terminal
- ⑬ EXT. TIMER IN (external timer trigger input) terminal
ALARM REST IN (alarm recording reset input) terminal
- ⑭ SERIES IN (series recording trigger input) terminal
- ⑮ CONTROL IN terminal
- ⑯ ALARM IN (alarm trigger input) terminal
1 SHOT IN (single image recording trigger input) terminal
- ⑰ AC power input

- ① DC power input (TLS-1960P only)
 - A DC12-24V IN “-” input terminal
 - B Do not use
 - C DC12-24V IN “+” input terminal
- ② RS-485/232C interface board (sold separately)
 - D RS-232C connector (D-sub 9-pin type)
 - E RS-485 A connector (RJ-11)
 - F RS-485 B connector (RJ-11)
 - G TERMINATE switch

NOTES:

- The above illustration shows the unit when the RS-485/232C interface board is installed. If no RS-485/232C interface board is installed, connectors and switches ② through to ③ do not appear.
- The terminal may be damaged by a torque of 0.49 N·m (5kg·cm) or more and by using screwdriver with a tip with a diameter of 6 mm or more.
- Do not connect the RS-485 A and RS-485 B connectors to a phone line.
- The ⑧, ⑩, ⑭ and ⑮ terminals can be used to select the input and output signals. (Refer to “SELECTING INPUT AND OUTPUT TERMINALS” on page 39.)
- If using the ⑩ and ⑮ terminals, multiple VCRs can be operated by operating a single VCR. (Refer to “SYNCHRONIZATION CONTROL” on page 41.)
- Pay attention to the polarity of the DC12-24V input terminal (“+”: red screw, “-”: black screw).

CONNECTIONS

Connect the video camera and TV monitor as shown in the figure below.

NOTE: Before making the connections, make sure the devices are disconnected from the power outlet.

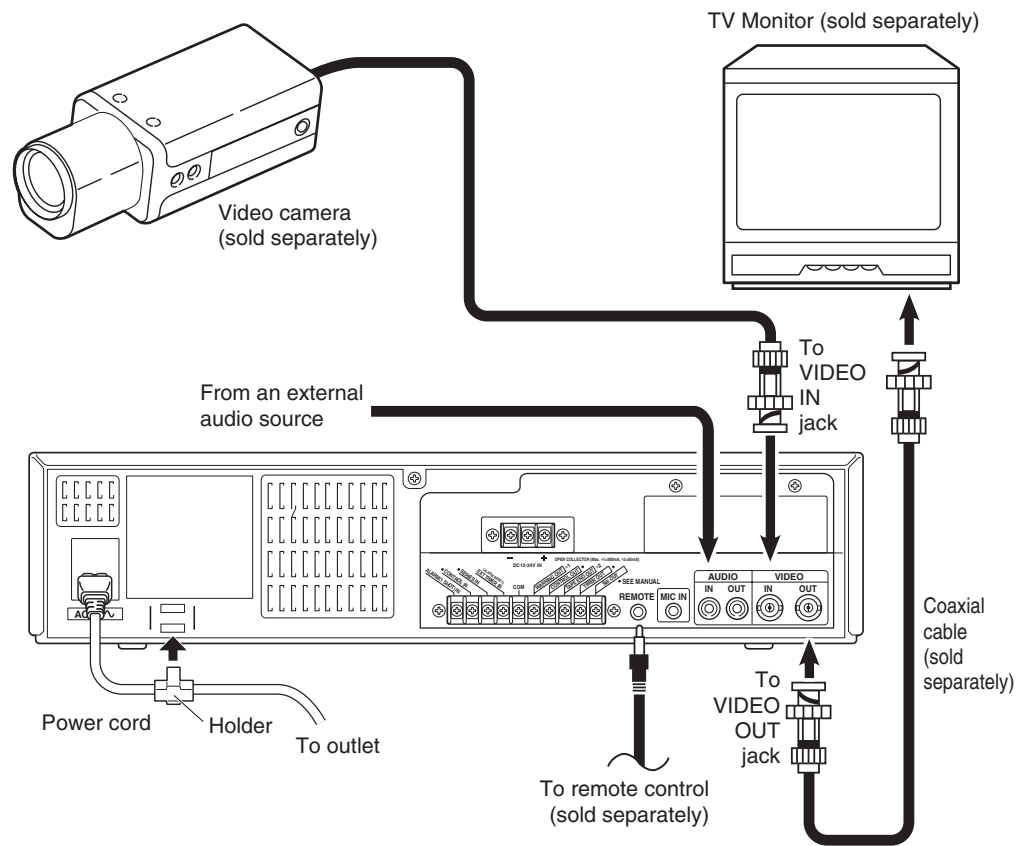

Power Cord Installation

- ❶ Plug the power cord (supplied) into the AC power input (AC IN ~) on the VCR back panel. Insert the plug straight and firmly.
- ❷ Insert the AC power cord into the holder.

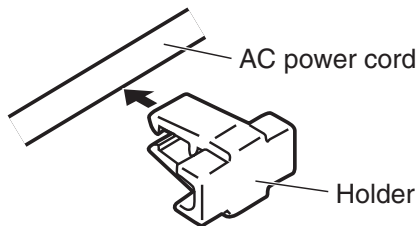

- ❸ Fix the holder to the VCR back panel.

NOTES:

- For more details, please refer to the manuals accompanying all other devices. If the connections are not made properly, it may cause a fire or damage the equipment.
- You can use a VA-RMN01 Remote Control Unit (sold separately) to control the VCR remotely.
- If there is no video signal when the power is turned on, "NO VIDEO" will be displayed on-screen.

NOTES (TLS-1960P only):

- Use a DC power cord rated A.W.G 18 (1.25 mm²) or more.
- The table below indicates the DC power source output and DC power maximum cord lengths.

DC power source output	DC power maximum cord lengths
18 V or more 2 A	6 m
12 ~ 16 V 3 A	6 m

ON-SCREEN MENU

Main Menu

To access on-screen menu

- ❶ Press the **STANDBY/ON** button.
- ❷ When no menu is displayed on-screen, press the **MENU** button.
 - *The MAIN MENU appears.*

MAIN MENU

```

<MAIN MENU>
1. LANGUAGE/CLOCK SET
2. DISPLAY/SW OUT SET
3. GENERAL SET
4. WARNING OUT/CONTR. SET
5. ALARM/SERIES REC SET
6. TAPE MANAGEMENT
7. TIMER SET
8. HOLIDAY SET
9. OTHERS
  
```

- ❸ Press the **MENU EXIT** (or **MENU**) button to return to the monitor screen.

Using the JOG dial and SHUTTLE ring for settings

JOG dial

Put the tip of your index finger into the depression, then turn the dial in any direction.

- When the display is highlighted in a sub-menu, turn the dial to select the setting item.
- When the display is highlighted in a MAIN MENU, select a sub-menu.
- While the display is flashing, turn the dial and the selected data setting will change or the selected setting value will increase or decrease.

SHUTTLE ring

- When a menu is being displayed, turn the ring 10° or more clockwise to change the selected setting item from highlighted to flashing.
- After making the setting, turn the ring clockwise to save the setting and move to the next setting.
- When a MAIN MENU is being displayed, turn the ring clockwise and the sub-menu for selection will appear.
- When a sub-menu is being displayed, turn the ring counterclockwise and the MAIN MENU will appear.
- If there are several items on one line, turn the ring clockwise to move to the next item (on the right) and confirm the setting. Turning the ring counterclockwise will restore the original setting condition and move to the previous item (on the left).

Sub-menus

To enter or modify settings within a sub-menu

- ❶ When a MAIN MENU is being displayed, turn the **JOG** dial to select one of the sub-menus, then turn the **SHUTTLE** ring clockwise.
 - *The selected sub-menu appears.*
- ❷ Turn the **JOG** dial to move the selection to the desired setting, then turn the **SHUTTLE** ring clockwise.
 - *The selected item flashes.*
- ❸ Turn the **JOG** dial to enter or modify the setting.
- ❹ Press the **MENU EXIT** button to save the settings and return to the monitor screen.

LANGUAGE/CLOCK SET menu

```

<LANGUAGE/CLOCK SET>
*LANGUAGE-LANGUE-IDIOMA
  -SPRACHE-LINGUA-R3bK
  ENGLISH
*CLOCK SET
01-01-2002 TUE 00:00:00
*SUMMER TIME SET NO USE
  WEEK MONTH TIME
ON LST-SUN 03 02:00
OFF LST-SUN 10 02:00
  
```

DISPLAY/SW OUT SET menu

```

<DISPLAY SET>   SET UP
DATE            Y
TIME            Y
SPEED          Y
ALARM COUNT    Y

<SW OUT SET>
TIMING         FIELD
FIELD          1
3H MODE       Y
  
```

GENERAL SET menu

```

<GENERAL SET>
TAPE IN MODE   STOP
TAPE END MODE  REW
CLOCK ADJUST  01:00
THREAD CHECK   N
VIDEO LOSS     N
CLOG DETECT.   N
REMOTE        MENU
VIDEO         COLOR
  
```

ON-SCREEN MENU

WARNING OUT/CONTROL SET menu

```

<WARNING OUT SET>SET UP
ALARM          Y
NON REC       N
MECHA. PROBLEM Y
VIDEO LOSS    Y
CLOG DETECT.  Y

<CONTROL SET>
EJECT MODE    EJECT1
OPERATION     SLAVE
    
```

NOTES:

- The "VIDEO LOSS" line does not appear if "VIDEO LOSS" is set to "N" in the (GENERAL SET) menu.
- The "CLOG DETECT." line does not appear if "CLOG DETECT." is set to "N" in the (GENERAL SET) menu.

ALARM/SERIES REC SET menu

```

<ALARM/SERIES REC SET>
*ALARM SET
MODE          Y1
SPEED         3H
DURATION      20S
*1 SHOT SET
FIELD         1
INTERVAL      1M
*SERIES REC   N
*TAPE END OUT 3:00
    
```

TAPE MANAGEMENT menu

```

<TAPE MANAGEMENT>
*TAPE MANAGEMENT N
*PROTECT DAY     30

*REC PASS SET    10
*GROUP NO. SET   OFF
*OVERRIDE        N
    
```

TIMER SET menu

```

<TIMER SET>
WEEK START STOP SPD
SUN  ---:---:---:--- N
MON  ---:---:---:--- N
TUE  ---:---:---:--- N
WED  ---:---:---:--- N
THU  ---:---:---:--- N
FRI  ---:---:---:--- N
SAT  ---:---:---:--- N
DAILY ---:---:---:--- N
EXT  ***** --- N
    
```

HOLIDAY SET menu

```

<HOLIDAY SET>
1  ---:---:---:---
2  ---:---:---:---
3  ---:---:---:---
4  ---:---:---:---
5  ---:---:---:---
6  ---:---:---:---
7  ---:---:---:---
8  ---:---:---:---
9  ---:---:---:---
10 ---:---:---:---
    
```

OTHERS menu

```

<OTHERS>
*ALARM LOG
*POWER FAILURE/DEW
*TERMINAL SET SET1
*RS-485 SET
STATUS INFO. Y
ALARM INFO.  Y
    
```

NOTE:

- This is the display when the RS-485/232C interface board is installed. The last three lines will not appear if this board is not installed.

ALARM LOG menu

```

<ALARM LOG>          000
001  ---:---:---:---
002  ---:---:---:---
003  ---:---:---:---
004  ---:---:---:---
005  ---:---:---:---
006  ---:---:---:---
007  ---:---:---:---
008  ---:---:---:---
009  ---:---:---:---
010  ---:---:---:---
    
```

POWER FAILURE/DEW/USED TIME menu

```

<POWER FAILURE>
000 FAILURE ---:---:---:---
RECOVERY ---:---:---:---

<DEW>
000 FAILURE ---:---:---:---
RECOVERY ---:---:---:---

<USED TIME>
VIDEO          00000H
POWER          00000H
    
```

NOTES:

- Setting items are highlighted (appear in blue characters) when they are selected.
- Settings flash while they are being changed.
- When a menu is displayed, recording will not be possible.
- During recording or playback the menus cannot be displayed.
- To reset the settings of a menu to their original values, select the desired menu and then press the **MENU RESET** button.
- The USED TIME data in the (POWER FAILURE/DEW/USED TIME) menu cannot be cleared even when the **MENU RESET** button is pressed.
- Press the **MENU** button to save any settings made and switch menu screens. To display the (ALARM LOG) menu or (POWER FAILURE/DEW/USED TIME) menu, select the "ALARM LOG" or "POWER FAILURE/DEW" line in the (OTHERS) menu and then turn the **SHUTTLE** ring clockwise.
- Turn the **SHUTTLE** ring counterclockwise while a setting item is highlighted (appears in blue characters) to return to the main menu. In the case of the (ALARM LOG) menu or the (POWER FAILURE/DEW/USED TIME) menu, to return to the (OTHERS) menu.

SETTING THE LANGUAGE AND CLOCK

Language Setting

English, French, Spanish, Portuguese, German, Italian or Russian can be selected by the user.

- ❶ Turn the power on to all devices used.
- ❷ Press the **MENU** button to display the MAIN MENU.
 - The "1.LANGUAGE/CLOCK SET" line appears highlighted.

```
<MAIN MENU>
1.LANGUAGE/CLOCK SET
2.DISPLAY/SW OUT SET
3.GENERAL SET
4.WARNING OUT/CONTR.SET
5.ALARM/SERIES REC SET
6.TAPE MANAGEMENT
7.TIMER SET
8.HOLIDAY SET
9.OTHERS
```

- ❸ Turn the **SHUTTLE** ring clockwise.
 - The (LANGUAGE/CLOCK SET) menu appears.
 - "ENGLISH" is highlighted (appears in blue characters).

```
<LANGUAGE/CLOCK SET>
*LANGUAGE-LANGUE-IDIOMA
  SPRACHE-LINGUA-R3BK
  ENGLISH
*CLOCK SET
  01-01-2002 TUE 00:00:00
*SUMMER TIME SET NO USE
  WEEK MONTH TIME
ON LST-SUN 03 02:00
OFF LST-SUN 10 02:00
```

- ❹ Turn the **SHUTTLE** ring clockwise.
 - The display colour for the selected item returns to the original colour and flashes.
- ❺ Turn the **JOG** dial to select the language of your choice.
 - To set the next item, turn the **SHUTTLE** ring clockwise, then turn the **JOG** dial to select the next setting.
- ❻ When finished, press the **MENU EXIT** button to return to the monitor screen.

Clock setting

Example: To set the clock to October 15, 2002 at 3:20 PM (15:20).

- ❶ Follow steps ❶ to ❸ under "Language Setting".
- ❷ Turn the **JOG** dial until the "CLOCK SET" setting is highlighted (appears in blue characters).
- ❸ Turn the **SHUTTLE** ring clockwise.
 - The day position starts flashing.
- ❹ Turn the **JOG** dial to set the day (15), then turn the **SHUTTLE** ring clockwise.
 - The day of week is set automatically.
- ❺ Turn the **JOG** dial to set the month (10), then turn the **SHUTTLE** ring clockwise.
- ❻ Turn the **JOG** dial to set the year (2002), then turn the **SHUTTLE** ring clockwise.
- ❼ Turn the **JOG** dial to set the hours (15 for 3 PM), then turn the **SHUTTLE** ring clockwise.
 - Unit uses 24hours format.
- ❽ Turn the **JOG** dial to set the minutes (20), then turn the **SHUTTLE** ring clockwise.

```
<LANGUAGE/CLOCK SET>
*LANGUAGE-LANGUE-IDIOMA
  -SPRACHE-LINGUA-R3BK
  ENGLISH
*CLOCK SET
  15-10-2002 TUE 15:20:00
*SUMMER TIME SET NO USE
  WEEK MONTH TIME
ON LST-SUN 03 02:00
OFF LST-SUN 10 02:00
```

- If a wrong setting has been entered, turn the **SHUTTLE** ring counterclockwise to move to the setting to be changed, then turn the **JOG** dial to enter the correct setting.
- ❾ For accurate clock setting, turn the **JOG** dial counterclockwise timed with a time broadcast or other accurate time signal. This will start the seconds counting from 00.
 - To set the next item, turn the **SHUTTLE** ring clockwise, then turn the **JOG** dial to select the next setting.
 - ❿ Press the **MENU EXIT** button to return to the monitor screen.

NOTE:

- In STOP mode, press and hold the **STOP** button then press the **TRACKING** – button to reset the minutes and seconds to 00 (to the closest hour). For example, between 13:30:00 and 14:29:59 the clock is reset to 14:00:00.

SETTING THE LANGUAGE AND CLOCK

Automatic Summer Time Adjustment

- ① Follow steps ① to ③ under “Language Setting” on page 11.

```

<LANGUAGE/CLOCK SET>
*LANGUAGE-LANGUE-IDIOMA
-SPRACHE-LINGUA-R33IK
ENGLISH
*CLOCK SET
15-10-2002 TUE 15:20:00
*SUMMER TIME SET NO USE
WEEK MONTH TIME
ON LST-SUN 03 02:00
OFF LST-SUN 10 02:00
    
```

- ② Turn the **JOG** dial until the “SUMMER TIME SET” setting is highlighted (appears in blue characters), then turn the **SHUTTLE** ring clockwise.
- ③ Turn the **JOG** dial to set the auto summer time/standard time adjustment, then turn the **SHUTTLE** ring clockwise.
- NO USE No summer time/standard time adjustment is made.
- USE The auto summer time/standard time adjustment is made.
- If using the “USE” setting, continue with steps ④ to ⑦.
- ④ Turn the **JOG** dial to select the “ON” line setting, then turn the **SHUTTLE** ring clockwise.
- The “LST” of the “ON” line flashes.
- ⑤ Set the day the summer time adjustment is made.
- Turn the **JOG** dial to set the week, then turn the **SHUTTLE** ring clockwise.
1ST, 2ND, 3RD, 4TH or LST (first, second, third, fourth or last)
 - Turn the **JOG** dial to set the day of week, then turn the **SHUTTLE** ring clockwise.
SUN, MON, TUE, SAT (Sunday, Monday, Tuesday....Saturday)
 - Turn the **JOG** dial to set the month the summer time adjustment is made, then turn the **SHUTTLE** ring clockwise.
01, 02,.....11, 12 (for January, February.....November, December)
 - Turn the **JOG** dial to set the time (hour) the summer time adjustment is made, then turn the **SHUTTLE** ring clockwise.
 - Turn the **JOG** dial to set the time (minutes) the summer time adjustment is made, then turn the **SHUTTLE** ring clockwise.

- ⑥ Turn the **JOG** dial to select the “OFF” line setting, then turn the **SHUTTLE** ring clockwise.
- The “LST” of the “OFF” line flashes.
- ⑦ Following the same procedure as above (step ⑥), set when the time is changed back from summer time to standard time.
- ⑧ Press the **MENU EXIT** button.

Factory setting:

	WEEK	MONTH	TIME
ON	LST-SUN	03	02:00 (AM)
OFF	LST-SUN	10	02:00 (AM)

SUPERIMPOSE DISPLAY

Selecting the Superimpose Display

You can select to display or not the date, time, tape speed mode and number of alarm recordings.

- 1 Turn the power on to all devices used.
- 2 Press the **MENU** button to display the MAIN MENU.
- 3 Turn the **JOG** dial to select the "2.DISPLAY/SW OUT SET" line, then turn the **SHUTTLE** ring clockwise.

o The (DISPLAY/SW OUT SET) menu appears.

<DISPLAY SET>	SET UP
DATE	Y
TIME	Y
SPEED	Y
ALARM COUNT	Y
<SW OUT SET>	FIELD
TIMING	1
FIELD	1
3H MODE	Y

- 4 Turn the **SHUTTLE** ring clockwise.
- 5 Turn the **JOG** dial to select the desired mode, then turn the **SHUTTLE** ring clockwise.
 - SET UP Set each item (Individual)
 - ALL Y To set all items to "Y"
 - ALL N To set all items to "N"

o If using the "SET UP" setting, continue with steps 6 to 8.
- 6 Turn the **JOG** dial until the item to be changed is highlighted, then turn the **SHUTTLE** ring clockwise.
- 7 Turn the **JOG** dial to set "Y" (displayed) or "N" (not displayed), then turn the **SHUTTLE** ring clockwise.
 - DATE The date appears
 - TIME The time appears
 - SPEED The recording /playback speed mode appears
 - ALARM COUNT The number of alarm recordings appears
- 8 Repeat steps 6 and 7 when setting other items.
- 9 When finished, press the **MENU EXIT** button.

NOTE:

- When the **ON SCREEN** button is pressed and the display appears, the items for which "Y" have been set are recorded. The items for which "N" was set at step 7 above are not recorded.

Changing the Superimpose Display Position

- 1 Turn the power on to all input devices to the VCR.
 - o The superimpose display appears.
 - o If the superimpose display does not appear, press the **ON SCREEN** button. The display will be turned on and off alternately each time the **ON SCREEN** button is pressed.

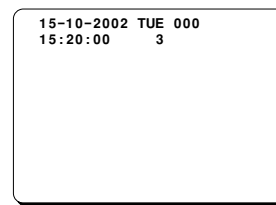

- 2 To change the display position, press the **SHIFT** → (or ↓) button.
 - o The display will move towards the right (or the bottom).

NOTES:

- If the **SHIFT** → (or ↓) button is kept pressed for 1 second or more, the display will move at a faster speed.
- The display position cannot be changed during recording.

VIDEO CASSETTE TAPES

Use only video cassette tapes bearing the VHS logo. This VCR was primarily designed for use with E-180 cassette tapes. It is recommended that you use E-180 standard grade VHS video cassette tapes for optimal performance.

NOTE:

- If using longer tapes (i.e. E-240) the tape travel will not be as stable and that may cause problems.

Handling Cassette Tapes

The cassette tapes should always be stored vertically in their cases, away from high temperatures, magnetic fields, direct sunlight, dirt, dust and locations subject to mold formation.

Do not tamper with the cassette mechanism and never touch the tape with your fingers.

Protect the cassette tapes from shocks and strong vibrations.

To Protect your Recordings

After having recorded a tape, if you wish to keep the recording, use a flat-tripped screwdriver to break off the erasure-prevention tab on the cassette.

To record again on a tape without an erasure-prevention tab, cover the hole with adhesive tape.

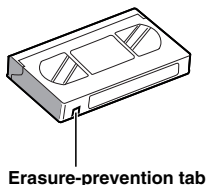

Erasure-prevention tab

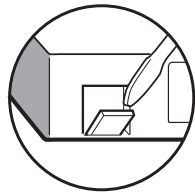

Loading

- 1 Place the cassette, label side up, in the loading slot. Gently push the centre of the cassette until it is loaded automatically.

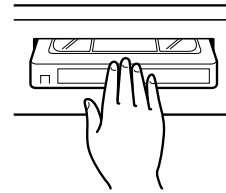

- The time display will switch to the reset counter "0H 00M 00S" display.
- The cassette indicator "●" lights on the digital display.

NOTE:

- If you try to record on a cassette without an erasure-prevention tab, the VCR will eject the cassette.

Unloading

- 1 In stop mode, press the **EJECT** button.
 - The cassette is automatically ejected.

NOTES:

- Do not insert any other object in the cassette loading slot, as that may cause injury and damage to the VCR.
- If your hand gets stuck in the cassette loading slot, unplug the power cord and consult the dealer where the unit was bought. Do not forcibly pull your hand out as that may cause severe injuries.

Precautions concerning the video cassette tapes

- Do not use tapes that are damaged, tapes that have been cut and repaired or tapes that have been altered in any way.
- Some rewinders may tangle the tape, and therefore their use is not recommended.
- When tapes are recorded over and over again, the recording quality will deteriorate. Refer to "Concerning the Number of Times Tapes can be Rerecorded on" on page 20, and replace the tape with a new tape as required.

VIDEO CASSETTE TAPES

Correct tape thread check function

This function checks to make sure that the cassette has been correctly loaded so that recording can be carried out.

NOTES:

- After the cassette tape is loaded, the mechanism will operate for about 5 seconds to check that the tape has been threaded (loaded) correctly automatically and the cassette indicator “●●” will flash during that period. If the tape is not loaded properly, the cassette will be ejected.
- If the **REC**, **PLAY** or **STOP** button is pressed or if the **SHUTTLE** ring is turned during the tape thread check operation, the command will only be executed after the tape thread has been checked. Only the **EJECT** button will operate while the tape thread is being checked.
- If “TAPE IN MODE” in the (GENERAL SET) menu is set to “REC”, the recording indicator “○” will light while the tape thread is being checked. However, recording will only start after the tape thread check is completed.

- ① Press the **STANDBY/ON** button.
- ② Press the **MENU** button to display the MAIN MENU.
- ③ Turn the **JOG** dial to select the “3.GENERAL SET” line, then turn the **SHUTTLE** ring clockwise.
 - *The (GENERAL SET) menu appears.*

<GENERAL SET>	
TAPE IN MODE	STOP
TAPE END MODE	REW
CLOCK ADJUST	01:00
THREAD CHECK	N
VIDEO LOSS	N
CLOG DETECT.	N
REMOTE	MENU
VIDEO	COLOR

- ④ Turn the **JOG** dial until the “THREAD CHECK” setting is highlighted, then turn the **SHUTTLE** ring clockwise.
- ⑤ Turn the **JOG** dial to select the desired mode, then turn the **SHUTTLE** ring clockwise.
 - N The correct tape thread check function is off
 - Y The correct tape thread check function is on
- ⑥ Press the **MENU EXIT** button.

Setting the Action to Take When a Cassette is Loaded

You can set the mode the VCR will go into when a cassette is loaded.

- ① Press the **STANDBY/ON** button.
- ② Press the **MENU** button to display the MAIN MENU.
- ③ Turn the **JOG** dial to select the “3.GENERAL SET” line, then turn the **SHUTTLE** ring clockwise.
 - *The (GENERAL SET) menu appears.*
- ④ Turn the **JOG** dial until the “TAPE IN MODE” setting is highlighted, then turn the **SHUTTLE** ring clockwise.
- ⑤ Turn the **JOG** dial to select the desired mode, then turn the **SHUTTLE** ring clockwise.
 - STOP When tape inserted the VCR, stays in stop mode
 - REC When tape inserted the VCR, goes into recording mode
- ⑥ Press the **MENU EXIT** button.

TAPE MANAGEMENT

This VCR is equipped with a tape management function. Using this function you can protect previous recordings and prevent overuse of the tape by controlling the tape protection term (number of days), the maximum number of re-recordings of the tape and the recording group. For details on how to set this function, refer to "Setting the Tape Management Function".

PROTECT DAY: To set the number of days before the tape can be rerecorded over.

REC PASS SET: To limit the number of rerecordings, in order to maintain a good image quality.

GROUP NO. SET: To manage tapes belonging to different recording groups.

NOTES:

- Before using this function, make sure that the clock is set properly.
- To use the tape management function, it must be set before recording is started.
- The tape management data is recorded at the beginning of the tape.

Operation

When the **REC** button is pressed, the VCR will rewind the tape to the beginning, and will play back some of the tape to check for the presence of tape management data (no image appears). The message "T. MANAGE. CHK" appears on-screen while the presence and type of data are being checked.

NOTE:

- When performing programme timer recording, single image recording and alarm recording, the tape management function will not operate even if it is active.

If no tape management data is present on the tape

Recording will start according to the settings in the (TAPE MANAGEMENT) menu.

When recording starts, the updated tape management data is recorded onto the tape.

If the tape has already been recorded on, the message "USED TAPE" will flash on-screen until recording starts.

If tape management data is present on the tape

The tape management data is checked and if there is no conflict, the VCR will rewind the tape to the beginning, then recording starts and the updated tape management data is recorded onto the tape. The message "T. MANAGE. OK" appears on-screen while the tape is being rewound and the tape management data is being recorded.

If a conflict is found when the tape management data is checked, the (TAPE MANAGEMENT) menu is displayed and the conflicting setting will flash. This menu will show the settings taken from the data recorded on the tape and not the current data settings held in the VCR's (TAPE MANAGEMENT) menu setting. Refer to "Tape Management Conflict Display" for detailed information.

NOTE:

- If the VCR is set for alarm recordings, alarms will be recorded based on the different settings. If an alarm signal is input while "T. MANAGE. CHK" is displayed, the alarms will be recorded after feeding a certain amount of tape but the data will not be recorded (updated). If an alarm signal is input during data recording, the alarms will be recorded after data recording.

IMPORTANT NOTES:

- If the tape management data cannot be read, the VCR will switch to stop mode and "DATA NG" will be displayed on-screen. This may indicate that the beginning of the tape (data recording/reading section) is damaged and the tape may be unusable. The message "DATA NG" will disappear when the **EJECT** or **PLAY** button is pressed.
- **Set the security lock function to on in order to protect the security of this feature.**

TAPE MANAGEMENT

Setting the Tape Management Function

- ❶ Press the **STANDBY/ON** button.
- ❷ Press the **MENU** button to display the MAIN MENU.
- ❸ Turn the **JOG** dial to select the "6.TAPE MANEGEMENT" line, then turn the **SHUTTLE** ring clockwise.
 - The (TAPE MANAGEMENT) menu appears.

<TAPE MANAGEMENT>	
*TAPE MANAGEMENT	N
*PROTECT DAY	30
*REC PASS SET	10
*GROUP NO. SET	OFF
*OVERRIDE	N

- ❹ Turn the **SHUTTLE** ring clockwise.
- ❺ Turn the **JOG** dial to select the desired mode, then turn the **SHUTTLE** ring clockwise.
 - N. The tape management function is not active.
 - Y. The tape management function is active.

When setting to "Y", please continue with the settings below.
- ❻ Turn the **JOG** dial until the "PROTECT DAY" setting is highlighted, then turn the **SHUTTLE** ring clockwise.
- ❼ Turn the **JOG** dial to select the desired number of days to protect the tape, then turn the **SHUTTLE** ring clockwise.
 - OFF The tape is not protected.
 - 1-255 . . . Number of days to protect the tape (prevent over-recording), from the date of the last recording on the tape (or the last expected recording date (calculated using the tape length (E-180) and the recording speed)).

NOTE:

- Since the last expected recording date is a calculated date (using the tape length (E-180) and the recording speed), it may be different from the actual last recording date, due to other settings such as alarm recordings, programme timer recordings and holiday settings.

- ❽ Turn the **JOG** dial until the "REC PASS SET" setting is highlighted, then turn the **SHUTTLE** ring clockwise.
- ❾ Turn the **JOG** dial to select the desired number of re-recording times, then turn the **SHUTTLE** ring clockwise.
 - OFF The number of re-recording times will not be checked.
 - 1-100 . . . Maximum number of re-recording times. (Refer to "Concerning the Number of Times Tapes can be Rerecorded on" on page 20.)

NOTES:

- Since data is read before it is recorded, the number of times will be incremented even if the recording is stopped before the end.
 - During autorepeat recording, the re-recording times count will be updated every time the tape is rewound to the beginning. Autorepeat recording will proceed even if the count exceeds the "REC PASS SET" setting.
- ❿ Turn the **JOG** dial until the "GROUP NO. SET" setting is highlighted, then turn the **SHUTTLE** ring clockwise.
 - ⓫ Turn the **JOG** dial to select the desired group number, then turn the **SHUTTLE** ring clockwise.
 - OFF The group number will not be checked.
 - 1-15 Group number setting.
 - ⓬ Turn the **JOG** dial until the "OVERRIDE" setting is highlighted, then turn the **SHUTTLE** ring clockwise.
 - ⓭ Turn the **JOG** dial to select the desired override mode, then turn the **SHUTTLE** ring clockwise. (Refer to "Tape Management Conflict Display" on the next page.)
 - N. Only **EJECT** button operation is accepted after a conflict has occurred.
 - Y. The next operation is accepted after a conflict has occurred. This will override setting.
 - ⓮ Press the **MENU EXIT** button.

NOTES:

- **Once the tape management data is recorded on tape, it cannot be changed.**
- The criteria (condition) for allowing recording will be based on the data recorded on the tape and not the settings in the (TAPE MANAGEMENT) menu.

TAPE MANAGEMENT

Tape Management Conflict Display

If a conflict that prevents recording is found when the tape management function checks the tape data, the (TAPE MANAGEMENT) menu appears with the conflicting setting flashing and the VCR go into the stop mode.

NOTES:

- If "OVERRIDE" is set to "N" (No), the conflicting setting is displayed flashing and the message (PRESS EJECT) appears at the bottom of the screen. Recording under these conditions is not possible. Press the **EJECT** button to eject the tape. To record on the same tape, set the "OVERRIDE" setting to "Y" and modify the conflicting setting, then insert the same tape and press the **REC** button. However, if only "PROTECT DAY" and "REC PAS SET" are modified, the menu will be displayed again. Press the **REC** button one more time to start recording. Recording starts and the tape data is updated.

Conflict display sample

<TAPE MANAGEMENT>	
*TAPE MANAGEMENT	Y
*PROTECT DAY	30
LAST D/M	NEXT D/M
15/10	15/11
*REC PASS SET	10
PASS COUNT	10
*GROUP NO. SET	7
REC GR. NO.	8
*OVERRIDE	N
(PRESS EJECT)	

- If the "OVERRIDE" is set to "Y" (Yes), the (TAPE MANAGEMENT) menu is displayed and conflicting setting preventing recording will flash and the VCR will switch to stop mode. To enter recording mode, press the **REC** button.

PROTECT DAY CONFLICT

The tape is protected, and the tape protection term (ex. 30 days) is not yet over.

Under "LAST D/M", the date of the last recording on the tape (or the last expected recording date (calculated using the tape length (E-180) and the recording speed)) is displayed.

Under "NEXT D/M", the date when it will be possible to record on the tape again is displayed.

REC PASS SET CONFLICT

The set number of recording passes has been reached.

The "PASS COUNT" shows the number of recording passes on the tape (ex. since the maximum recording passes number is set to "10", this prevents further recording.)

NOTES:

- When conducting Autorepeat recording, if the "PASS COUNT" exceeds 100, "101*" will be displayed flashing.
- If using a tape recorded previously on a different type of VCR (no tape data), when the set number of recordings is exceeded, "USED" will flash next to the "PASS COUNT" number.

GROUP NO. SET CONFLICT

The group numbers do not match.

The "REC GR. NO." shows the tape recording group number (ex. this tape belongs to a different recording group number 8 than the one set 7.)

NORMAL RECORDING

Normal Recording

Before starting

- Turn the power on to all devices used.
- Load a cassette tape with its erasure-prevention tab intact.

NOTES:

- If "TAPE IN MODE" is set to "REC" in the (GENERAL SET) menu, recording will start.
- Press the **ON SCREEN** button to display the superimpose display.

- 1 Press the **REC/PLAY SPEED** ▼ (or ▲) button to set the recording speed mode.
 - The recording speed mode appears on-screen and on the digital display.
- 2 Press the **REC** button.
 - The record indicator "○" lights.
 - Recording starts.
 - If the tape end is reached while recording, "OFF" is displayed on the digital display and the unit goes into the mode set at the "TAPE END MODE" setting in the (GENERAL SET) menu. To cancel the "OFF" display, press the **STOP**, **EJECT** or **PLAY** button or turn the **SHUTTLE** ring.
 - When the end of the tape is reached, the **TAPE END OUT** terminal output will be 0V. To cancel the output, press the **STOP** button.
- 3 To stop recording, press the **STOP** button.

NOTES:

- A tape recording made on this VCR may not play back with the same degree of clarity on a time lapse video cassette recorder from another manufacturer.
- If you press the **REC** button and the loaded cassette has no erasure-prevention tab, the VCR will eject the cassette.

[Recording Speed Mode]

- The available recording speed modes vary depending on the VCR model.

(TLS-1960P only)

Recording speed mode (hour mode)	Maximum recording duration (hours)	Recording interval (second)	Audio recording	Tape motion
3	3	1/50	Possible	Continuous
12	15	5/50		
24	27	9/50		
48	51	17/50	Not possible	Intermittent
72	75	25/50		
96	99	33/50		
120	123	41/50		
168	171	57/50		
240	243	81/50		
360	363	121/50		
480	483	161/50		
720	723	241/50		
960	963	321/50		
000	Single image recording			

(TLS-9924P only)

Recording speed mode (hour mode)	Maximum recording duration (hours)	Recording interval (second)	Audio recording	Tape motion
3	3	1/50	Possible	Continuous
12	15	5/50		
24	27	9/50		
000	Single image recording		Not possible	Intermittent

NORMAL RECORDING

Record Pause

Recording can be interrupted temporarily.

- ① Press the **STILL/PAUSE** button during recording.
 - The pause/still indicator “ || ” flashes.

NOTES:

- The image appears on-screen but it is not recorded.
 - If a recording pause continues for 5 minutes or more, the VCR will switch to stop mode to avoid damaging the tape.
- ② To resume recording, press the **REC** button, or press the **STILL/PAUSE** button again.

Recording Check

The image being recorded can be checked.

- ① During recording, press the **REC CHECK** button.
 - The tape will be rewound and then played back. The VCR will then return to the previous recording mode.

NOTE:

- During recording check operations, recording is suspended momentarily.

Concerning the Number of Times Tapes can be Rerecorded on

Depending on the recording speed mode, the tape must be replaced after a certain number of recording times.

Refer to the table below for the maximum number of times a tape can be recorded on.

Recording speed mode (hour mode)	Maximum number of recording times (with a standard grade tape)
3	100
12	50
24	50
48	25
72	15
96	10
120	10
168	5
240	5
360	3
480	2
720	1
960	1
000	1

NOTES:

- The maximum number of recording times will vary depending on the location and kind of tape used. Verify the recording quality and replace the tape when the quality starts to deteriorate. The maximum number of recording times indicated above are based on test tapes (E-180) used by the company.
- It is recommended that tape be changed at least as often as in the above table to provide good picture quality in the mode above.

NORMAL RECORDING

Clog Detection

This VCR is equipped with a clog detection function.

The recording quality is monitored automatically. When the heads are dirty and the recording quality deteriorates, the output at the **WARNING OUT** terminal becomes 0 V (Low) (Refer to "WARNING OUT Terminal" on page 47), the "○" indicator flashes on the digital display.

Setting the clog detection

- ① Press the **STANDBY/ON** button.
- ② Press the **MENU** button to display the MAIN MENU.
- ③ Turn the **JOG** dial to select the "3.GENERAL SET" line, then turn the **SHUTTLE** ring clockwise.
 - *The (GENERAL SET) menu appears.*

<GENERAL SET>	
TAPE IN MODE	STOP
TAPE END MODE	REW
CLOCK ADJUST	01:00
THREAD CHECK	N
VIDEO LOSS	N
CLOG DETECT.	N
REMOTE	MENU
VIDEO	COLOR

- ④ Turn the **JOG** dial until the "CLOG. DETECT." setting is highlighted, then turn the **SHUTTLE** ring clockwise.
- ⑤ Turn the **JOG** dial to select the desired mode, then turn the **SHUTTLE** ring clockwise.
 - N. Recording quality is not monitored
 - Y. Recording quality is monitored
- ⑥ Press the **MENU EXIT** button.

NOTES:

- To cancel the "○" indicator display and reset the **WARNING OUT** terminal output, press the **STOP** button.
- Clog detection is not possible if recording in 3-hour mode.

Action to Take when the Video Signal Deteriorates

If there is no video signal during recording or when a menu is not displayed (in stop, fast forward or rewind modes, etc.), "VIDEO LOSS" can be displayed on-screen. If in the (WARNING OUT/CONTROL SET) menu, "VIDEO LOSS" is set to "Y", the output at the **WARNING OUT** terminal becomes 0V (Low) (Refer to "WARNING OUT Terminal" on page 47).

- ① Press the **STANDBY/ON** button.
- ② Press the **MENU** button to display the MAIN MENU.
- ③ Turn the **JOG** dial to select the "3.GENERAL SET" line, then turn the **SHUTTLE** ring clockwise.
 - *The (GENERAL SET) menu appears.*
- ④ Turn the **JOG** dial until the "VIDEO LOSS" setting is highlighted, then turn the **SHUTTLE** ring clockwise.
- ⑤ Turn the **JOG** dial to select the desired mode, then turn the **SHUTTLE** ring clockwise.
 - N The video loss warning is not active.
 - Y The video loss warning is active.
- ⑥ Press the **MENU EXIT** button.

NORMAL RECORDING

Setting the Mode at the End of the Tape

You can select the mode on the VCR when the tape reaches the end during recording.

- ① Press the **STANDBY/ON** button.
- ② Press the **MENU** button to display the MAIN MENU.
- ③ Turn the **JOG** dial to select the "3.GENERAL SET" line, then turn the **SHUTTLE** ring clockwise.
 - The (GENERAL SET) menu appears.

<GENERAL SET>	
TAPE IN MODE	STOP
TAPE END MODE	REW
CLOCK ADJUST	01:00
THREAD CHECK	N
VIDEO LOSS	N
CLOG DETECT.	N
REMOTE	MENU
VIDEO	COLOR

- ④ Turn the **JOG** dial until the "TAPE END MODE" setting is highlighted, then turn the **SHUTTLE** ring clockwise.
- ⑤ Turn the **JOG** dial to select the desired mode, then turn the **SHUTTLE** ring clockwise.
 - **Setting when not using Autorepeat recording**
 - REW. Rewinds the tape to the beginning, then goes to stop mode
 - STOP. Goes to stop mode
 - EJECT The cassette is ejected
 - **Setting when using Autorepeat recording**
 - REPEAT1. . . Autorepeat recording mode is automatically canceled if there was an alarm trigger
 - REPEAT2. . . Autorepeat recording mode is active even if there was an alarm trigger
- ⑥ Press the **MENU EXIT** button.

Setting the video input signal

The video input signal during recording can be set to either colour or black & white.

- ① Press the **STANDBY/ON** button.
- ② Press the **MENU** button to display the MAIN MENU.
- ③ Turn the **JOG** dial to select the "3.GENERAL SET" line, then turn the **SHUTTLE** ring clockwise.
- ④ Turn the **JOG** dial until the "VIDEO" setting is highlighted, then turn the **SHUTTLE** ring clockwise.
- ⑤ Turn the **JOG** dial to select the desired mode, then turn the **SHUTTLE** ring clockwise.
 - COLOR For recording in colour
 - B/W For recording in black & white
- ⑥ Press the **MENU EXIT** button.

NOTES:

- Set to "COLOR" for systems which include colour signals (including cases where black & white signals are mixed in), and set to "B/W" for systems which only use black & white signals.
- Use the same setting for recording and playback.
- If tapes that have been recorded in black & white are played back when the setting is at "COLOR", the recordings will not be played back in colour.
- If using a black & white camera, set to "B/W". Recordings will not be made in colour even if "COLOR" is set.

AUTOREPEAT RECORDING

Autorepeat Recording

The same tape can be recorded over many times.

- Follow the **Before starting** steps, under “NORMAL RECORDING”.
- ① Press the **MENU** button to display the MAIN MENU.
- ② Turn the **JOG** dial to select the “3.GENERAL SET” line, then turn the **SHUTTLE** ring clockwise.
 - *The (GENERAL SET) menu appears.*

<GENERAL SET>	
TAPE IN MODE	STOP
TAPE END MODE	REW
CLOCK ADJUST	01:00
THREAD CHECK	N
VIDEO LOSS	N
CLOG DETECT.	N
REMOTE	MENU
VIDEO	COLOR

- ③ Turn the **JOG** dial until the “TAPE END MODE” setting is highlighted, then turn the **SHUTTLE** ring clockwise.
- ④ Turn the **JOG** dial to set to “REPEAT1” or “REPEAT2” (Refer to “Setting the Mode at the End of the Tape.” on page 22), then turn the **SHUTTLE** ring clockwise.
- ⑤ Press the **MENU EXIT** button.
 - *The REPEAT indicator lights.*
- ⑥ Press the **REC/PLAY SPEED** ▼ (or ▲) button to set the recording speed mode.
- ⑦ Press the **REC** button.
 - *Recording starts. When the tape end is reached, the VCR will rewind it to the beginning, and recording will resume.*
 - *When the end of the tape is reached, “OFF” will be displayed and TAPE END OUT terminal output will 0 V, until the rewinding operation starts.*

NOTES:

- If there is an alarm trigger during autorepeat recording, “A” is displayed on the digital display and alarm recording will take place. (Refer to “ALARM RECORDING” on page 24.)
- If the “TAPE END MODE” setting is “REPEAT1”, the REPEAT indicator will go off if there is an alarm trigger. After alarm recording, the recording will continue to the end of the tape then it will be rewound to the beginning and stop. “OFF” will be displayed on the digital display. To turn off the “OFF” display, press the **STOP**, **EJECT** or **PLAY** button or turn the **SHUTTLE** ring.
- If “AL” appears on the digital display and the “TAPE END MODE” setting is “REPEAT1”, autorepeat recording is not possible.

ALARM RECORDING

By connecting the **ALARM IN** terminal to a normally open door switch, an interphone, etc., a recording can be done only when necessary.

Alarm Recording Setting

Alarm recording is performed when there is an input (trigger) at the **ALARM IN** terminal.

- Make all necessary connections.
 - The alarm triggers are received while in recording, stop and stand-by modes.
 - Follow the **Before starting** steps, under "NORMAL RECORDING".
- 1 Press the **MENU** button to display the MAIN MENU.
 - 2 Turn the **JOG** dial to select the "5.ALARM/SERIES REC SET" line, then turn the **SHUTTLE** ring clockwise.
 - o *The (ALARM/SERIES REC SET) menu appears.*

<ALARM/SERIES REC SET>	
*ALARM SET	
MODE	Y1
SPEED	3H
DURATION	20S
*1 SHOT SET	
FIELD	1
INTERVAL	1M
*SERIES REC	N
*TAPE END OUT	3:00

- 3 Turn the **JOG** dial until the "MODE" setting is highlighted, then turn the **SHUTTLE** ring clockwise.
- 4 Turn the **JOG** dial to set the desired alarm recording mode, then turn the **SHUTTLE** ring clockwise.
 - Y1. Alarm recording is done when there is an alarm trigger.
 - Y2. Alarm recording is done only when there is an alarm trigger during duration of programmed timer recording.
 - Y3. Alarm recording is done only if there is an alarm trigger and the VCR is not in programmed timer recording mode.
 - Y4. Alarm recording is done only when there is an alarm trigger during programmed timer recording duration. VCR comes on records only for alarm duration. Timer recording is not possible.
 - N. Alarm recording is not performed even if there is an alarm trigger.
- 5 Turn the **SHUTTLE** ring clockwise.

- 6 Turn the **JOG** dial to set the desired alarm recording speed, then turn the **SHUTTLE** ring clockwise.
 - 3H. 3-hour mode recording
 - 12H. 12-hour mode recording
 - 24H. 24-hour mode recording
 - NC Recording at the speed already set
- 7 Turn the **SHUTTLE** ring clockwise.
- 8 Turn the **JOG** dial to set the desired alarm recording duration (20S, 40S, 1M, 2M, 3M, 4M, 5M, or CC), then turn the **SHUTTLE** ring clockwise.
 - 20S-5M. Recording only for the displayed duration
 - CC Recording as long as the alarm signal is being input (minimum 5 seconds)
- 9 Press the **MENU EXIT** button.

NOTES:

- During alarm recording all buttons are disabled.
- If "OFF" appears on the digital display, alarm recording is not possible in order to prevent the recorded tape to be recorded over. To cancel the "OFF" display, press the **STOP**, **EJECT** or **PLAY** button or turn the **SHUTTLE** ring.
- If an alarm trigger is received while alarm recording is in progress, recording duration for the second alarm will be calculated from that point. The alarm counter will register the alarm, but it will not be found during an alarm scan and alarm search.
- If there is a power failure during alarm recording, and the power is restored within the recording set duration, alarm recording will continue.
- If the alarm recording duration is short, the alarms may not be found during an alarm scan or an alarm search. If the alarms are going to be reviewed using alarm scan or alarm search, then in 3-hour mode, 20-second or more recording duration should be used.
- To do alarm recording during series recording, set "MODE" to "Y1" or "Y3". Alarm recording will be conducted only if the VCR is recording.
- If the recording speed mode is "000", the recording will be in 3-hour mode irrespective of the alarm recording speed mode setting.

ALARM RECORDING

Alarm Recording Reset Function

To stop the recording of an alarm, close the connection between the **ALARM RESET IN** terminal and the **COM** terminal during alarm recording.

Alarm Recording Counter Display

- During alarm recording, "A" will be flashing on the digital display.
- If a superimpose display is being displayed and "ALARM COUNT" has been set to "Y" in the (DISPLAY/SW OUT SET) menu, the number of alarm recordings will flash on the monitor screen.
- The maximum display number of alarm recordings is "999". At the next alarm recording the counter will indicate "000".
- When the (ALARM LOG) menu appears, press the **MENU RESET** button to reset the alarm counter to "000" (all the data of the (ALARM LOG) menu is reset).

Connections to the ALARM IN Terminal

- Alarm input signal
Connect a make-contact (no voltage) switch between the **ALARM IN** and **COM** terminals.

Checking the Alarm Recordings Time

- 1 Press the **STANDBY/ON** button.
- 2 Press the **MENU** button to display the MAIN MENU.
- 3 Turn the **JOG** dial to select the "9.OTHERS" line, then turn the **SHUTTLE** ring clockwise.
 - *The (OTHERS) menu appears.*

```
<OTHERS>
*ALARM LOG
*POWER FAILURE/DEW
*TERMINAL SET SET1
```

- 4 Turn the **JOG** dial to select the "ALARM LOG" line, then turn the **SHUTTLE** ring clockwise.
 - *The (ALARM LOG) menu appears.*
 - *The number of alarm recordings, and the 10 most recent alarm recording times are displayed.*

```
<ALARM LOG> 010
001 25-12 19:00
002 25-11 23:00
003 25-10 15:00
004 25-10 08:00
005 25-10 06:00
006 22-10 19:00
007 22-10 17:15
008 22-10 15:45
009 20-10 10:00
010 18-10 12:00
```

- Continue turning the **JOG** dial to display the next (or previous) 10 alarm recording entries. When the number of alarm recording entries reaches 100, the older ones are erased as new ones are memorized.

- 5 Press the **MENU EXIT** button.

NOTE:

- If the **MENU RESET** button is pressed while the (ALARM LOG) menu is displayed, the displayed data is erased. "AL" will be erased from the digital display.

ALARM RECORDING

Alarm Search

To go to the beginning of a desired alarm recording.

- ❶ Press the **STANDBY/ON** button.
- ❷ Press the **SEARCH** button during stop mode.
 - "AL SEARCH 01" appears on screen.
- ❸ Press the **REC/PLAY SPEED** ▼ (or ▲) button to set the desired alarm number (01 to 99), then turn the **SHUTTLE** ring clockwise (or counterclockwise).
 - The desired alarm is searched for and a still image of the beginning of the alarm recording appears on-screen.

NOTE:

- The alarm number is relative to the actual tape position. (Please refer to the illustration below.)

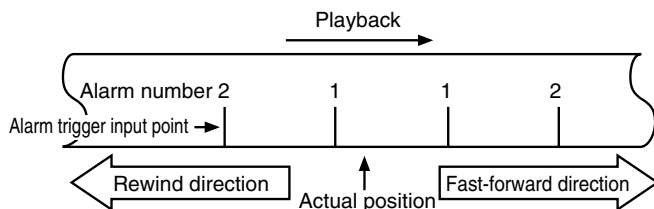

- ❹ Press the **PLAY** button.
 - Playback starts.

NOTES:

- If the end of the tape is reached during a search, the tape will rewind and stop. If the beginning of the tape is reached, it will stop.
- This function does not operate when a warning display appears on the digital display.

Alarm Scan

To look for an alarm recording by viewing the first 5 seconds of each alarm recording.

- ❶ Press the **STANDBY/ON** button.
- ❷ Press the **SEARCH** button twice during stop mode.
 - "AL SCAN" will be displayed on screen.
- ❸ Turn the **SHUTTLE** ring clockwise (or counterclockwise).
 - The unit will advance (or rewind) the tape at high speed and playback the first 5 seconds of every alarm recording.
 - To cancel the alarm scan mode, press the **STOP** button.
- ❹ While the desired recording is being played back, press the **PLAY** button.
 - Playback starts and alarm scan mode is canceled.

NOTES:

- If the end of the tape is reached during a scan, the tape will rewind and stop. If the beginning of the tape is reached, it will stop.
- This function does not operate when a warning display appears on the digital display.

PROGRAMME TIMER RECORDING

There are three programme timer recording methods, daily recording, weekly recording or recording on certain days of the week.

Example 1: To record on every Saturday from 9:00 AM to 5:00 PM (17:00), in 24-hour mode (recording speed).

- Follow the **Before starting** steps, under "NORMAL RECORDING".
- ❶ Press the **MENU** button to display the MAIN MENU.
- ❷ Turn the **JOG** dial to select the "7.TIMER SET" line, then turn the **SHUTTLE** ring clockwise.
 - The (TIMER SET) menu appears.

<TIMER SET>			
WEEK	START	STOP	SPD
SUN	---	---	N
MON	---	---	N
TUE	---	---	N
WED	---	---	N
THU	---	---	N
FRI	---	---	N
SAT	---	---	N
DAILY	---	---	N
EXT	*****	*****	N

- ❸ Turn the **JOG** dial until the "SAT" (Saturday) line is highlighted, then turn the **SHUTTLE** ring clockwise.
- ❹ Turn the **JOG** dial to change the weekday, then turn the **SHUTTLE** ring clockwise.
 - If no change, turn the **SHUTTLE** ring clockwise.
 - The recording start hour position starts flashing.

NOTE:

- All of the lines other than the bottom line can be set to "SUN", "MON", "TUE", "WED", "THU", "FRI", "SAT", "DAILY", "MO-SA" (Monday to Saturday) or "MO-FR" (Monday to Friday).

- ❺ Turn the **JOG** dial to set the recording start hour (ex: 09), then turn the **SHUTTLE** ring clockwise.
 - The recording start minutes position starts flashing.
- ❻ Turn the **JOG** dial to set the recording start minutes (ex: 00), then turn the **SHUTTLE** ring clockwise.
 - The recording stop hour position starts flashing.
- ❼ Turn the **JOG** dial to set the recording stop hour (ex: 17), then turn the **SHUTTLE** ring clockwise.
 - The recording stop minutes position starts flashing.

- ❽ Turn the **JOG** dial to set the recording stop minutes (ex: 00), then turn the **SHUTTLE** ring clockwise.
 - The "SPD" (recording speed) position will start flashing.

NOTE:

- If the set stop time is earlier than or the same time as the set start time, the VCR will consider the stop time to be the following day, and "T" will be displayed next to the recording stop time.

- ❾ Turn the **JOG** dial to select the recording speed mode (ex: 24), then turn the **SHUTTLE** ring clockwise.
 - "N" will start flashing.

- ❿ Turn the **JOG** dial to select the desired programme timer recording mode (Y), then turn the **SHUTTLE** ring clockwise.

Y Recording will take place
 N Recording will not take place

<TIMER SET>			
WEEK	START	STOP	SPD
SUN	---	---	N
MON	---	---	N
TUE	---	---	N
WED	---	---	N
THU	---	---	N
FRI	---	---	N
SAT	09:00	17:00	24 Y
DAILY	---	---	N
EXT	*****	*****	N

- Repeat steps ❸ to ❿ to programme timer recordings for other days of the week.
- If a wrong setting has been entered, turn the **SHUTTLE** ring counterclockwise to move to the setting to be changed, then turn the **JOG** dial to enter the correct setting.

- ⓫ Press the **MENU EXIT** button.

- ⓬ Press the **TIMER** button.

○ The timer recording indicator "□" will light on the digital display. The VCR is now in timer recording stand-by mode.

NOTE:

- To modify, cancel or stop timer recording, press the **TIMER** button to cancel the timer recording mode.

PROGRAMME TIMER RECORDING

A timer recording of more than 24 hours can only be set on the 7th (SAT) and 8th (DAILY) lines of the (TIMER SET) menu.

Example 2: To record every week from Friday at 9:00 PM (21:00) to Monday at 7:00 AM, in 96-hour mode (recording speed).

- Follow the **Before starting** steps, under “NORMAL RECORDING”.

- Follow steps ① and ② under “PROGRAMME TIMER RECORDING” on page 27.

○ The (TIMER SET) menu appears.

<TIMER SET>			
WEEK	START	STOP	SPD
SUN	--:--	--:--	--- N
MON	--:--	--:--	--- N
TUE	--:--	--:--	--- N
WED	--:--	--:--	--- N
THU	--:--	--:--	--- N
FRI	--:--	--:--	--- N
SAT	--:--	--:--	--- N
DAILY	--:--	--:--	--- N
EXT	*****	*****	--- N

- Turn the **JOG** dial until the “SAT” (Saturday) line is highlighted, then turn the **SHUTTLE** ring clockwise.
- Turn the **JOG** dial, to set the desired start day of the week (ex: FRI), then turn the **SHUTTLE** ring clockwise.
- Turn the **JOG** dial to set the recording start hour (ex: 21), then turn the **SHUTTLE** ring clockwise.
- Turn the **JOG** dial to set the recording start minutes (ex: 00), then turn the **SHUTTLE** ring clockwise.
- Turn the **JOG** dial to set “**” for the recording stop hour, then turn the **SHUTTLE** ring clockwise.
 - The rest of the line settings will change to “** : ** *** *”, the day of the next line will change to the next day and the start time will change to “** : **” automatically.
- Turn the **JOG** dial to set the desired stop day of the week (ex: MON), then turn the **SHUTTLE** ring clockwise.
- Turn the **JOG** dial to set the recording stop hour (ex: 07), then turn the **SHUTTLE** ring clockwise.
- Turn the **JOG** dial to set the recording stop minutes (ex: 00), then turn the **SHUTTLE** ring clockwise.
- Turn the **JOG** dial to select the recording speed mode (ex: 96), then turn the **SHUTTLE** ring clockwise.

- Turn the **JOG** dial to select “Y”.

<TIMER SET>			
WEEK	START	STOP	SPD
SUN	--:--	--:--	--- N
MON	--:--	--:--	--- N
TUE	--:--	--:--	--- N
WED	--:--	--:--	--- N
THU	--:--	--:--	--- N
FRI	--:--	--:--	--- N
FRI	21:00	**:**	*** *
MON	**:**	07:00	96 Y
EXT	*****	*****	--- N

- Press the **MENU EXIT** button.

- Press the **TIMER** button.

PROGRAMME TIMER RECORDING

Setting the Holidays

By setting the holidays, timer recording will be conducted on those days, as set for Sundays.

- ❶ Press the **STANDBY/ON** button.
- ❷ Press the **MENU** button to display the MAIN MENU.
- ❸ Turn the **JOG** dial to select the "8.HOLIDAY SET" line, then turn the **SHUTTLE** ring clockwise.
 - *The (HOLIDAY SET) menu appears.*

<HOLIDAY SET>	
1	11
2	12
3	13
4	14
5	15
6	16
7	17
8	18
9	19
10	20

- ❹ Turn the **JOG** dial to select the desired line, then turn the **SHUTTLE** ring clockwise.
- ❺ Turn the **JOG** dial to set day of the holiday, then turn the **SHUTTLE** ring clockwise.
- ❻ Turn the **JOG** dial to set month of the holiday, then turn the **SHUTTLE** ring clockwise.
 - *Repeat steps ❹ to ❻ to set up to 20 holidays.*
- ❼ Press the **MENU EXIT** button.

NOTES:

- If setting holidays, be sure that a timer recording is set for Sunday. If not, this function will not operate.
- If a timer recording for Sundays is entered, the holidays timer recording will not function if the programme timer recording mode is set to "N".
- If timer recording has been set for 24 hours or more, after midnight the recording will be carried out according to the (TIMER SET) menu settings, even if holiday timer recording has been set.
- To erase a setting, follow the same procedure as above, but at step ❺ and ❻, enter "--" instead of a setting.

Changing a Programme Timer Recording

- ❶ Follow steps ❶ and ❷ under "PROGRAMME TIMER RECORDING" on page 27.
- ❷ Turn the **JOG** dial until the setting (line) to be changed is highlighted, then turn the **SHUTTLE** ring clockwise.
- ❸ Turn the **SHUTTLE** ring clockwise, until the setting to correct is flashing.
- ❹ Turn the **JOG** dial, to correct the setting.
- ❺ Press the **MENU EXIT** button, then press the **TIMER** button.

To Cancel a Programme Timer Recording

- ❶ Follow steps ❶ and ❷ under "PROGRAMME TIMER RECORDING" on page 27.
- ❷ Turn the **JOG** dial until the setting (line) to be canceled is highlighted, then turn the **SHUTTLE** ring clockwise.
- ❸ Turn the **SHUTTLE** ring clockwise, until "Y" is flashing.
- ❹ Turn the **JOG** dial, to select "N".
- ❺ Press the **MENU EXIT** button, then press the **TIMER** button.

To cancel all programme timer recordings

- ❶ Follow steps ❶ and ❷ under "PROGRAMME TIMER RECORDING" on page 27.
- ❷ Press the **MENU RESET** button.
 - *All programmed timer recordings are erased.*
- ❸ Press the **MENU EXIT** button.

PROGRAMME TIMER RECORDING

NOTES:

- During timer recording or timer recording stand-by, all the buttons on the VCR, except the **TIMER** button and the buttons to set/cancel the security lock (see page 38), are disabled.
- If the power fails, the recording will be interrupted. When the power is restored, the recording will resume if the stop time has not yet been reached, and "P" will be displayed on the digital display. The VCR internal battery is completely recharged after the VCR has been connected to a live outlet for 48 hours, and it will maintain all the VCR settings memory for up to 30 days.
- Set the timer recordings so that the recording times do not overlap. If they do, the one with the earliest recording start time will have priority. (See chart below.)

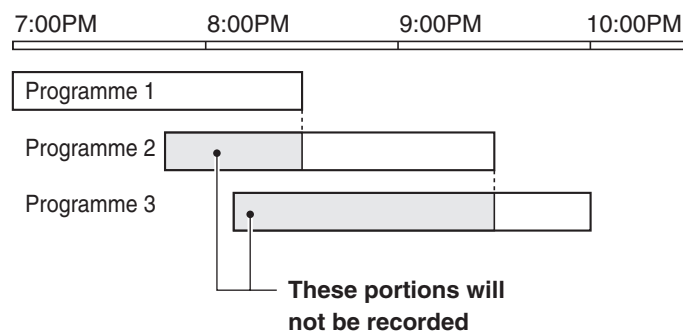

- If no timer recording is set or a cassette without erasure-prevention tab is loaded, when the **TIMER** button is pressed the timer recording indicator "P" will start flashing.
- If "OFF" is displayed on the digital display, timer recording is not possible in order to prevent the recorded tape to be recorded over.
- If the recording speed mode has been set to "000", single image recordings will be made.

RECORDING USING AN EXTERNAL TIMER INPUT

Recording can be controlled by an external start/stop signal input at the **EXT TIMER IN** terminal.

While there is input at the **EXT TIMER IN** terminal, the external input indicator "E" will light on the digital display and the input will be recorded. Recording will stop when there are no more input signals.

Example 3: To record using the signal input at the **EXT TIMER IN** terminal, in 24-hour mode.

- Follow the **Before starting** steps, under "NORMAL RECORDING".

NOTE:

- External timer input recording can only be set on the "EXT" line of the (TIMER SET) menu.
- 1 Follow steps 1 and 2 under "PROGRAMME TIMER RECORDING" on page 27.
 - 2 Turn the **JOG** dial until the "EXT" line is highlighted, then turn the **SHUTTLE** ring clockwise.
 - 3 Turn the **JOG** dial to select the recording speed mode (ex: 24), then turn the **SHUTTLE** ring clockwise.
 - 4 Turn the **JOG** dial to select "Y".

<TIMER SET>			
WEEK	START	STOP	SPD
SUN	--:--	--:--	--- N
MON	--:--	--:--	--- N
TUE	--:--	--:--	--- N
WED	--:--	--:--	--- N
THU	--:--	--:--	--- N
FRI	--:--	--:--	--- N
SAT	--:--	--:--	--- N
DA I L Y	--:--	--:--	--- N
EXT	*****	*****	24 Y

- 5 Press the **MENU EXIT** button.
- 6 Press the **TIMER** button.

NOTES:

- Alarm recording is not possible using this function.
- Alarm recording reset function is not possible using this function.
- Other timer recordings using the standard procedure can also be programmed.

SERIES RECORDING

Using 2 VCRs or more, the series recording function lets you switch recording from one unit to the next (only with VCRs of the same model as this one).

Series Recording Setup

- Connect 2 VCRs or more as illustrated below.
- Follow the **Before starting** steps, under "NORMAL RECORDING".
- ❶ Press the **REC/PLAY SPEED** ▼ (or ▲) button to set the recording speed mode.
- ❷ Set the following items as indicated.

Item	VCR No.1	VCR No.2 and on
Cassette tape	Loaded	Loaded
Operation mode	Stop	Stop
"TAPE END MODE"(in (GENERAL SET) menu)	REW, STOP or EJECT	REW, STOP or EJECT
"SERIES REC" (in (ALARM/SERIES REC SET) menu)	Y (YES)	Y (YES)
Timer recording	OFF (not set)	OFF (not set)
Power	ON	Stand-by
Security lock	Canceled	Set

- ❸ Press the **REC** button on VCR No.1.
 - *Recording will start in series recording mode.*
- ❹ Set the security lock on VCR No.1.

Operation

The output signal at the **TAPE END OUT** terminal will be present either at the point when the counter reading is 3H 00M 00S or when VCR No. 1 reaches the end of the tape, whichever is first.

When this signal is received by VCR No. 2, it will start recording.

When the tape end is reached, operation is then carried out according to the "TAPE END MODE" setting in the (GENERAL SET) menu.

NOTES:

- When using tapes that are based on the VHS standard, a single tape can be used to record 3H 00M 00S or more based on the counter setting.
- If "SERIES REC" is set to "N" in the (ALARM/SERIES REC SET) menu, series recording will not be possible.
- The counter must start from the beginning of tape, or the series recording out will not function properly.
- Even if "OFF" is displayed, series recording will be conducted if there is an input at the **SERIES IN** terminal.

Loop recording

- Connect the output from the **TAPE END OUT** terminal of the last VCR to the **SERIES IN** terminal of the first VCR.
- The "TAPE END MODE" in (GENERAL SET) menu should be set to "REW" for all units without fail.
- In loop recording mode, the tape will be re-recorded over. If you need to keep the recorded information, please eject the tape after recording is complete and insert a new tape.

Connection

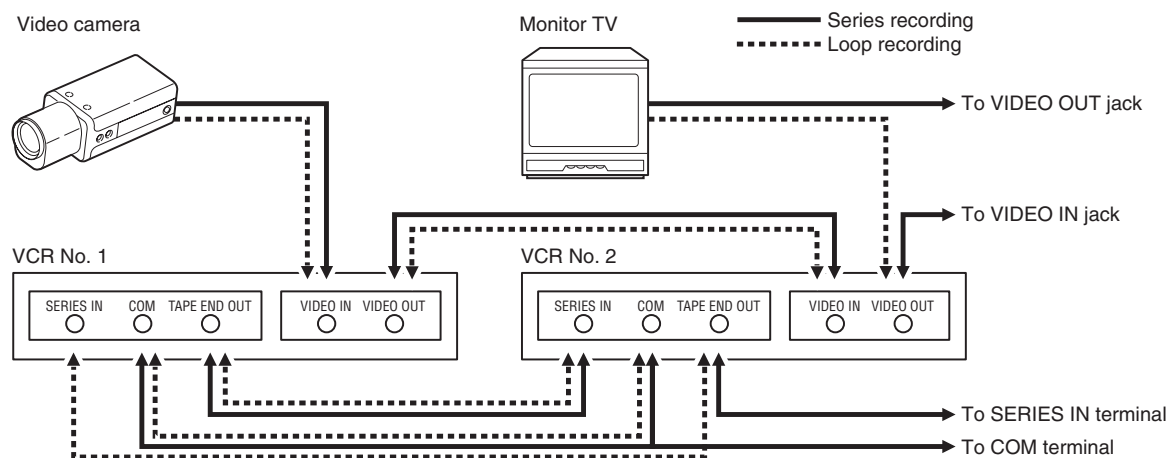

SINGLE IMAGE RECORDING

The single image recording function of this VCR can be used to create image data files or animations.

Single Image Recording Setup

- Follow the **Before starting** steps, under "NORMAL RECORDING".
- ❶ In stop mode, press the **REC/PLAY SPEED** ▼ (or ▲) button, to set the recording speed to "000".
- ❷ Press the **MENU** button to display the MAIN MENU.
- ❸ Turn the **JOG** dial to select the "5.ALARM/SERIES REC SET" line, then turn the **SHUTTLE** ring clockwise.

○ The (ALARM/SERIES REC SET) menu appears.

<ALARM/SERIES REC SET>	
*ALARM SET	
MODE	Y1
SPEED	3H
DURATION	20S
*1 SHOT SET	
FIELD	1
INTERVAL	1M
*SERIES REC	N
*TAPE END OUT	3:00

- ❹ Turn the **JOG** dial until the "FIELD" setting is highlighted, then turn the **SHUTTLE** ring clockwise.
- ❺ Turn the **JOG** dial to set the number of fields (images) to record every time(1, 2, 3, 4, 5, 10, 30, 60), then turn the **SHUTTLE** ring clockwise.
- ❻ Turn the **SHUTTLE** ring clockwise.
- ❼ Turn the **JOG** dial to set the interval between each image recording (1M, 2M, 3M), then turn the **SHUTTLE** ring clockwise.
- ❽ Press the **MENU EXIT** button.
- ❾ Press the **REC** button.
 - The single image recording mode will be activated (the VCR will be in recording stand-by mode).
- ❿ Press the **REC** button one more time, or send a trigger through the **1 SHOT IN** terminal on the back panel, to start the single image recording.

NOTE:

- If a setting other than "1" is selected for "FIELD" at step ❺, recording will be done in 120-hour mode. The recording speed cannot be modified.
- ❿ When finished, press the **STOP** button.

NOTES:

- The trigger at the **1 SHOT IN** terminal should be on for 0.1 sec. or more.
- The trigger interval at the **1 SHOT IN** terminal varies according to the number of images to record, but should be over 1 sec.
- Alarm recording is not possible during single image recording.
- During the "INTERVAL" period set for single image recording, the **WARNING OUT** terminal will not be 0 V even if the "NON REC" on the (WARNING OUT/CONTROL SET) menu is set to "Y".
- If a single image recording trigger is not received (or if the **REC** button is not pressed) during the duration set for "INTERVAL", single image recording will be conducted automatically after the set duration.
- If a single image recording trigger is received (or if the **REC** button is pressed) during the duration set for "INTERVAL", single image recording will be conducted immediately.
- When using the **1 SHOT IN** terminal, connect a make-contact switch (no voltage) between the **1 SHOT IN** and **COM** terminals.

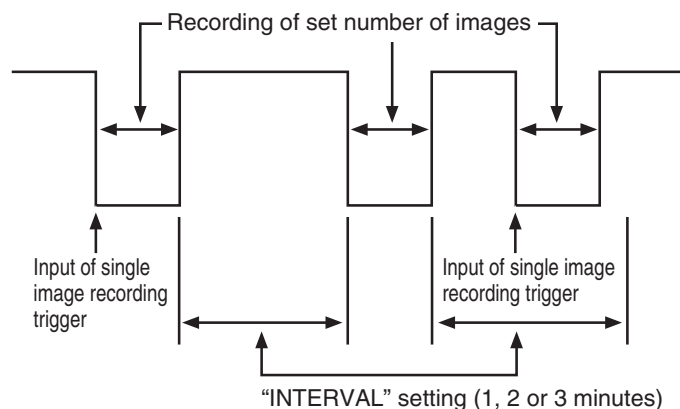

NORMAL PLAYBACK

Normal Playback

- ❶ Turn on the power to the VCR and TV monitor.
- ❷ Load the video cassette tape.
- ❸ Press the **REC/PLAY SPEED** ▼ (or ▲) button to select the playback speed mode.
 - *The selected playback speed mode is displayed on the digital display.*

NOTES:

- A slow motion effect or accelerated playback effect can be achieved by using a slower or faster playback speed than the speed used for recording.
 - If the playback speed mode is set to "000", playback (step ❶) will not be possible.
- ❹ Press the **PLAY** button.
 - *Playback starts.*
 - *If necessary, adjust the tracking to eliminate the noise from the picture.*
 - *If the image is unstable (rolling vertically), adjust the vertical lock control to correct.*
 - ❺ To stop playback, press the **STOP** button.
 - *To advance (or rewind) the tape, turn the SHUTTLE ring clockwise (or counterclockwise).*

NOTE:

- A tape recorded on a time lapse video cassette recorder produced by another manufacturer may not play back with the same degree of clarity on this unit.

Tracking Control

If there is noise in the image during playback,

- ❶ While looking at the playback picture, press the **TRACKING+** button repeatedly to minimize the noise.
- ❷ If it cannot be minimized, press the **TRACKING-** button repeatedly.

NOTE:

- This function does not operate when a warning display appears on the digital display.

Vertical Lock Control

During still image mode,

- ❶ Press the **V. LOCK+** button repeatedly to reduce the vertical rolling of the image.
- ❷ If it cannot be corrected, press the **V. LOCK-** button repeatedly.

NOTE:

- This function does not operate when a warning display appears on the digital display.

Sharpness Control

- ❶ During playback, press and hold the **SHARPNESS** button for 3 seconds or more.
 - *"SH - : -" appears on the digital display.*
- ❷ Press the **SOFT** (or **SHARP**) button for the desired sharpness of the image.
- ❸ When finished, press the **SHARPNESS** button.

NOTE:

- This function does not operate when a warning display appears on the digital display.

Audio Playback

- Audio playback is only possible in 3-hour, 12-hour and 24-hour modes.
- The playback speed has to be the same as the recording speed, for normal playback of the audio.
- For a tape recorded in 12-hour and 24-hour recording modes, to playback the audio, press the **AUDIO ON** button after pressing the **PLAY** button. "A" will be displayed to the left of the playback speed on the digital display.

SPECIAL PLAYBACK

Picture Search (Forward and Reverse)

- ❶ Turn the **SHUTTLE** ring clockwise (or counterclockwise), during normal playback. See "SHUTTLE Ring Operation".
 - *The image can be seen while the tape is advanced (or rewind) at high speed.*
- ❷ To return to normal playback, release the **SHUTTLE** ring.

NOTES:

- During picture search, noise (horizontal bars) will appear in the picture.
- The sound is muted.

Still Image

- ❶ Press the **STILL/PAUSE** button, during normal playback.
 - *A still image can be viewed.*
- ❷ To return to normal playback, press the **PLAY** button.

NOTES:

- If still mode continues for 5 minutes or more, the VCR will go into stop mode to avoid damaging the tape.
- If the image is unstable (rolling vertically), adjust the vertical lock control to correct.
- The sound is muted.

Field Advance (Forward and Reverse)

- ❶ Turn the **JOG** dial clockwise (or counterclockwise), during still image mode.
 - *The still image is advanced (or rewind) of one image (field).*
 - *Turn the dial faster to increase the speed of the field advance.*
- ❷ To return to normal playback, press the **PLAY** button.

NOTES:

- During reverse field advance, noise will appear in the picture.
- If field advance mode continues for 5 minutes or more, the VCR will switch to stop mode to avoid damaging the tape.
- The sound is muted.

Reverse Playback

- ❶ Turn the **SHUTTLE** ring counterclockwise and hold it, during normal playback. See "SHUTTLE Ring Operation".
 - *Reverse playback will start.*
- ❷ To return to normal playback, release the **SHUTTLE** ring.

NOTES:

- During reverse playback, noise will appear in the picture.
- If operated from normal playback mode, reverse playback is only possible during 3-hour playback speed mode.
- The sound is muted.

Slow motion (Forward and Reverse)

- ❶ Turn the **SHUTTLE** ring clockwise (or counterclockwise) and hold it, during still image mode. See "SHUTTLE Ring Operation".
 - *Forward (or reverse) slow motion playback will start.*
- ❷ To return to normal playback, press the **PLAY** button.

NOTES:

- If slow motion mode continues for 5 minutes or more, the VCR will switch to stop mode to avoid damaging the tape.
- The sound is muted.

SPECIAL PLAYBACK

SHUTTLE Ring Operation

From normal playback, still image, stop mode, etc., turn the clockwise or counterclockwise to select a mode as indicated below.

- 1 Turn the **SHUTTLE** ring in either direction where the desired mode is selected.

 : Operation will not return to the original mode when the **SHUTTLE** ring is released.

Reverse direction	Original mode	Forward direction
-------------------	---------------	-------------------

Shuttle operations that cannot use the **SHUTTLE HOLD** button.

Rewind		Stop		Fast forward
Rewind		Fast forward		Forward picture search (Locked)
Reverse picture search (Locked)		Rewind		Fast forward
Reverse picture search (Locked)		*1		Fast forward
Rewind		*2		Forward picture search (Locked)

Shuttle operations that can use the **SHUTTLE HOLD** button.

Reverse picture search	Reverse playback		Normal playback	Normal playback		Forward picture search
Reverse picture search	Reverse playback	Reverse Slow motion	Still image	Slow motion	Normal playback	Forward picture search

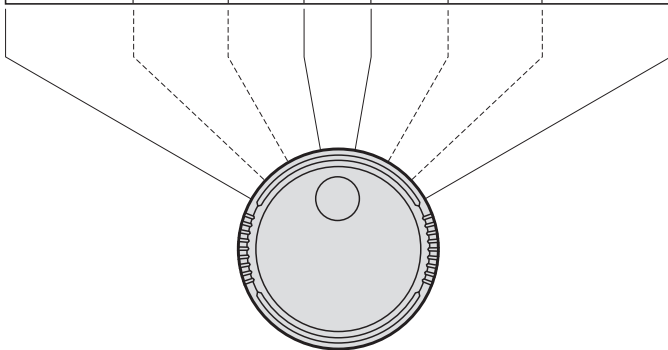

*1: Forward picture search.

*2: Reverse picture search.

NOTES:

- If operated from still image mode and playback mode, operation will return to the original mode when the **SHUTTLE** ring is released.
- If operated from normal playback mode, reverse playback is only possible during 3-hour playback speed mode.
- The sound is muted.
- While turning the **SHUTTLE** ring, press the **SHUTTLE HOLD** button. The operation in progress at that time will continue even when the **SHUTTLE** ring is released. To stop the operation, press the **SHUTTLE HOLD** button or the **STOP** button, or turn the **SHUTTLE** ring.

DAY/TIME SEARCH

Day/Time Search

This searches for a specified day/time for still images to be played back.

- ① Press the **STANDBY/ON** button.
- ② Press the **SEARCH** button three times during stop mode.
 - "T/D SEARCH 01 00:00" will be displayed on screen.
- ③ Press the **REC/PLAY SPEED** ▼ (or ▲) button to set the desired day, then press the **SHIFT** → button.
- ④ Press the **REC/PLAY SPEED** ▼ (or ▲) button to set the desired hour, then press the **SHIFT** → button.
- ⑤ Press the **REC/PLAY SPEED** ▼ (or ▲) button to set the desired minutes.

NOTES:

- The setting can be made in 10 minutes increments only.
 - For recordings made on other VCRs, the exact time may not be found even if the minutes are entered. For tapes recorded on older models of VCRs produced by this company (the ones without a minutes setting for the day/time search function), make sure to set the minutes to "00".
- ⑥ Turn the **SHUTTLE** ring clockwise (or counterclockwise).
 - *The desired day/time is searched and a still image of the recording will appear on-screen.*
 - ⑦ Press the **PLAY** button.
 - *Playback will start.*

NOTES:

- If the end of the tape is reached during a search, the tape will rewind and stop. If the beginning of the tape is reached, it will stop.
- The alarm and day/time data are recorded on the tape in a similar format. If they overlap, the alarm data will have the priority. Therefore, when searching for a day/time when an alarm recording was done, the day/time search will not stop at the desired location. In such a case, use alarm scan to find the desired recording location.
- The day/time search function may not operate correctly if searching for a timer recording time or if the clock on the recording VCR has been adjusted using the **CLOCK ADJUSTMENT** function.
- If the recording has been made in 120-hour or more mode, the day/time search with a minutes setting (see step ⑤ above) will not operate. When using the day/time search function on such a recording, set the minutes (see step ⑤ above) to "00".
- If a recording on a tape extends for over a one month period, the same day may be present twice on the tape. If such a day is searched, since there is no month search setting, the desired day may not be found.
- This function does not operate when a warning display appears on the digital display.

TAPE COUNTER

Using the counter, it is easy to find a desired recording.

- ① Press the **COUNTER RESET** button, at the beginning of the desired recording.
 - *The counter will be reset to "0H 00M 00S".*
- ② Press the **COUNTER MEMORY** button.
 - "M" appears on the digital display.
 - *To cancel the counter memory function, press the **COUNTER MEMORY** button a second time.*
- ③ After recording or playback, turn the **SHUTTLE** ring counterclockwise from stop mode.
 - *The tape is rewound to the counter "0H 00M 00S" reading.*
 - *If you rewind the tape past the "0H 00M 00S" position, turn the **SHUTTLE** ring clockwise.*

NOTES:

- There is no tape counter indication for the blank portions of the tape.
- In the 3-hour recording speed mode only, the tape counter indicates real hours, minutes and seconds.
- In the other recording speed modes, the tape counter indication is a ratio of the 3-hour mode base indication. (In 24-hour recording mode, each "second" of the tape counter actually represents approximately $27/3 = 9$ real seconds.)
- There may be a slight discrepancy between the position shown on the tape counter and the actual tape position.
- When rewinding the tape past the "0H 00M 00S" position, a minus (-) sign will be displayed.

SECURITY LOCK

This VCR is equipped with two types of security lock: a quick method security lock and a 4 digit security lock.

The security lock function is designed to prevent accidental stopping of recording if the **STOP** button is pressed inadvertently.

NOTE:

- The security lock cannot be engaged while a menu is displayed.

Quick Method Security Lock

- 1 While holding the **SHIFT** → button, press the **REC/PLAY SPEED** ▲ button.

○ “**!**” appears on the digital display.

To cancel the security lock, while holding the **SHIFT** → button, press the **REC/PLAY SPEED** ▼ button, “**!**” will be erased from the digital display.

NOTES:

- While the security lock is engaged all commands, except the one to cancel the security lock, are disabled.
- The quick method security lock will be cancelled by pressing the **ALL RESET** button.

4 Digit Security Lock

When the security lock is applied, the VCR cannot be operated by someone who does not know the correct password. You need to enter the password in order to operate the VCR.

Setting the 4 digit security lock

- 1 Press the **SECURITY LOCK** button.
 - “----” appears on the digital display.
- 2 Use the **JOG** dial and **SHUTTLE** ring to set the 4 digit pass word.
 - JOG** dial To select a digit
 - SHUTTLE** ring To move between digits
 - When the 4th digit is entered and the **SHUTTLE** ring is then turned clockwise, the lock is engaged and “**!**” appears on the digital display.

NOTE:

- When the digits are entered and the **SHUTTLE** ring is turned clockwise, the numerals are replaced by “-” characters.

Cancel the 4 digit security lock

- 1 Press any button.
 - “**!**” flashes in the digital display for 3 seconds, and then “----” appears.
- 2 Use the **JOG** dial and **SHUTTLE** ring to set the 4 digit pass word.
 - JOG** dial To select a digit
 - SHUTTLE** ring To move between digits
 - When the 4th digit is entered and the **SHUTTLE** ring is then turned clockwise, the lock is disengaged and “**!**” disappears from the digital display.
 - If the password is incorrect, the VCR returns to the initial condition.

NOTE:

- Operation 2 should be carried out within 7 seconds of starting setting 1.

CLOCK ADJUSTMENT

The time for the second and subsequent VCRs can be set to the same time as the first VCR.

A signal from a separate device can also be used to set the time for the second and subsequent VCRs to the same time as the first VCR. When using the signal from a separate device to set the time, input a 0 V signal to the **CONTROL IN** terminal of the first VCR for 100 ms or longer.

- 1 Press the **STANDBY/ON** button.
- 2 Press the **MENU** button to display the MAIN MENU.
- 3 Turn the **JOG** dial to select the "3.GENERAL SET" line, then turn the **SHUTTLE** ring clockwise.
- 4 Turn the **JOG** dial until the "CLOCK ADJUST" setting is highlighted, then turn the **SHUTTLE** ring clockwise.
- 5 Turn the **JOG** dial to set the hour at which the adjustment will be conducted, then turn the **SHUTTLE** ring clockwise.

NOTE:

- The clock adjustment cannot be set to "00:00".

Example

<GENERAL SET>	
TAPE IN MODE	STOP
TAPE END MODE	REW
CLOCK ADJUST	03:00
THREAD CHECK	N
VIDEO LOSS	N
CLOG DETECT.	N
REMOTE	MENU
VIDEO	COLOR

- 6 Press the **MENU EXIT** button.
The setting procedure on the first VCR is now completed.
- 7 Repeat the procedure for all the other VCRs, setting "CLOCK ADJUST" (to the same time as set on the first VCR).

NOTE:

- This function will not operate on the day the summer/standard time is changed.

Connection

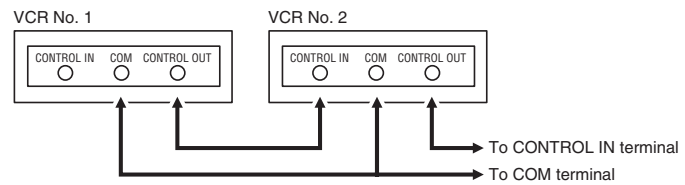

SELECTING INPUT AND OUTPUT TERMINALS

The input and output terminal signals can be selected so that the VCR can be connected to older models of VCR.

- 1 Press the **STANDBY/ON** button.
- 2 Press the **MENU** button to display the MAIN MENU.
- 3 Turn the **JOG** dial to select the "9. OTHERS" line, then turn the **SHUTTLE** ring clockwise.
 - o The (OTHERS) menu appears.

<OTHERS>
*ALARM LOG
*POWER FAILURE/DEW
*TERMINAL SET SET1

- 4 Turn the **JOG** dial until the "TERMINAL SET" setting is highlighted, then turn the **SHUTTLE** ring clockwise.

- 5 Turn the **JOG** dial to select the desired mode, then turn the **SHUTTLE** ring clockwise.
 - SET1 According to indication on back panel. (Select when not connecting to an older model.)
 - SET2 **CONTROL IN** is set to **CLOCK IN**, **SERIES IN** is set to **EJECT IN**, **CONTROL OUT** is set to **CLOCK OUT** and **TIMER OUT** is set to **EJECT OUT**. (Select when connecting to an older model.)

- 6 When finished, press the **MENU EXIT** button.

NOTE:

- If set to "SET2", the "SERIES REC" line will not appear in the (ALARM/SERIES REC SET) menu.

SETTING THE CASSETTE EJECT MODE

Cassette Eject Setup

When using two or more VCRs, the cassette tapes of all the VCRs or some of the VCRs can be ejected at the same time.

NOTE:

- "TERMINAL SET" in the (OTHERS) menu should always be set to "SET2".
- ❶ Press the **STANDBY/ON** button.
- ❷ Press the **MENU** button to display the MAIN MENU.
- ❸ Turn the **JOG** dial to select the "4.WARNING OUT/CONTR. SET" line, then turn the **SHUTTLE** ring clockwise.
 - The (WARNING OUT/CONTROL SET) menu appears.

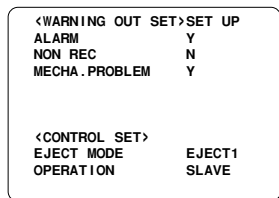

- ❹ Turn the **JOG** dial until the "EJECT MODE" setting is highlighted, then turn the **SHUTTLE** ring clockwise.
- ❺ Turn the **JOG** dial to select the desired cassette eject mode, then turn the **SHUTTLE** ring clockwise.
 - EJECT1 The cassette is ejected only if the VCR is not in recording or recording pause mode.
 - EJECT2 The cassette is ejected only if the VCR is in stop mode.
- ❻ Turn the **JOG** dial until the "OPERATION" setting is highlighted, then turn the **SHUTTLE** ring clockwise.
- ❼ Turn the **JOG** dial to select the desired operation, then turn the **SHUTTLE** ring clockwise.
 - SLAVE The function is restricted to only the VCR being operated.
 - MASTER . . . The function is applied to the VCR being operated and all VCRs that are connected after it.
- ❽ Press the **MENU EXIT** button.

NOTE:

- The **EJECT** button will not be operative during recording mode.

Connection

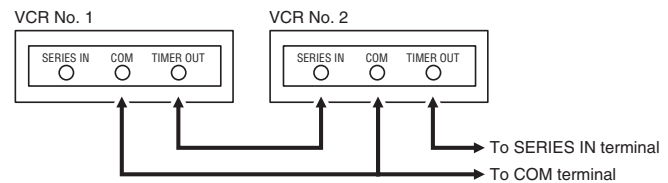

Eject input (SERIES IN) terminal

- Depending on the "EJECT MODE" setting in the (WARNING OUT/CONTROL SET) menu (see "Cassette Eject Setup"), the cassette loaded into the VCR can be ejected when there is input to this terminal.

Eject output (TIMER OUT) terminal

- A signal is output from this terminal when the **EJECT** button is pressed (if the VCR is set up as the "MASTER" VCR; see step ❷ under "Cassette Eject Setup") or when there is input (a trigger) at the **SERIES IN** terminal, even if the security lock is set or a cassette is not loaded.

NOTES:

- The terminal names and signals are different from the usual setting.
- Names in brackets apply to terminals on the rear panel.

SYNCHRONIZATION CONTROL

When two or more VCRs are connected together, the VCRs can be operated simultaneously just by operating the VCR that has been set to "MASTER", without using a system controller (sold separately).

There are two modes available: operator mode and administrator/installer mode. The operations that can be carried out in each mode are different.

NOTES:

- The operation and setting can only be carried out with the button of this unit.
- Use cables with a thickness of A.W.G.24 (0.2 mm²) or more and a length no more than 1.5 m to connect VCRs.
- It is recommended that you do not connect any more than 10 VCRs together.
- Only one VCR can be specified at the master unit.
- Do not mix operator mode and administrator/installer mode in the same installation.
- Do not connect the VCRs in a loop.
- "TERMINAL SET" in the (OTHERS) menu should always be set to "SET1".
- The VCR operation may not be completely synchronized depending on the VCR statuses, the operating environment and the operation timing. It is recommended that you check the operating statuses and menus after carrying out each operation.

Connection

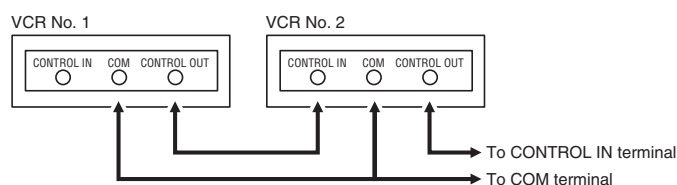

Operator Mode

This mode lets you carry out basic operations (ejecting, recording, stopping, rewinding, changing the recording speed mode and power on/stand-by).

NOTE:

- This mode will not work correctly unless the VCRs are in the same initial state.

- 1 Press the **STANDBY/ON** button.
- 2 Press the **MENU** button to display the MAIN MENU.
- 3 Turn the **JOG** dial to select the "4.WARNING OUT/CONTR. SET" line, then turn the **SHUTTLE** ring clockwise.

○ The (WARNING OUT/CONTROL SET) menu appears.

<WARNING OUT SET>SET UP	
ALARM	Y
NON REC	N
MECHA. PROBLEM	Y
<CONTROL SET>	
EJECT MODE	EJECT1
OPERATION	SLAVE

- 4 Turn the **JOG** dial until the "OPERATION" setting is highlighted, then turn the **SHUTTLE** ring clockwise.
- 5 Turn the **JOG** dial to select the desired operation, then turn the **SHUTTLE** ring clockwise.

SLAVE The function is restricted to only the VCR being operated.

MASTER The function is applied to the VCR being operated and all VCRs that are connected after it.

- When the "OPERATION" is set to "MASTER", "SC" lights on the digital display.

- 6 Press the **MENU EXIT** button.

SYNCHRONIZATION CONTROL

Setting the Cassette Eject Mode

Operator mode can be used to eject cassettes for all VCRs or for specified VCRs.

- ❶ Follow steps ❶ to ❺ under "Operator Mode".
- ❷ Turn the **JOG** dial until the "EJECT MODE" setting is highlighted, then turn the **SHUTTLE** ring clockwise.
- ❸ Turn the **JOG** dial to select the desired cassette eject mode, then turn the **SHUTTLE** ring clockwise.
 - EJECT1 The cassette is ejected only if the VCR is not in recording or recording pause mode.
 - EJECT2 The cassette is ejected only if the VCR is in stop mode.
- ❹ Press the **MENU EXIT** button.

Administrator/Installer Mode

This mode lets you carry out basic operations (ejecting, recording, stopping, rewinding, changing the recording speed mode and power on/stand-by) and also make menu settings.

NOTES:

- This mode will not work correctly unless the VCRs are in the same initial state.
- Menu settings will not work correctly unless the menu settings for the VCRs are the same. Set the menu settings for each VCR to the initial setting before using this mode to change the settings.
- If a power failure occurs, make the settings again.
- ❶ Press the **STANDBY/ON** button.
- ❷ While holding the **STOP** button, press the **STILL/PAUSE** button for 3 seconds or more on the VCR that is set to be the master VCR.
 - "SC" will flash on the digital display.
 - "SC" flashes (master) . The menu settings can be changed for the VCR being operated and all VCRs that are connected after it.
 - This mode can be used regardless of the "OPERATION" setting in the (WARNING OUT/CONTROL SET) menu.
 - "SC" off (slave) The menu settings can be changed for only the VCR being operated.
- To cancel the master mode, press and hold the **STOP** button and then press the **STILL/PAUSE** button.

SETTING FOR RS-485 OR RS-232C USE

The RS-485 interface can be used to operate the VCR using a SANYO brand system controller. Furthermore, the RS-232C interface can be used to operate the VCR using a computer.

NOTES:

- This can only be used when the RS-485/232C interface board (VZU-485/232C) is installed.
- Refer to the instruction manuals for the VZU-485/232C, the system controller and/or the computer.

Setting the Address and Data Transfer Speed

- Make this setting without a cassette tape inserted.
- 1 Press the **COUNTER RESET** button for 3 seconds or more.
 - "485" or "232" appears on the digital display.
 - 2 Turn the **JOG** dial to select the interface being used, RS-232C or RS-485.
 - "232" or "485" appears on the digital display.
 - When setting "232", carry out step 3 and then step 6.
 - 3 Turn the **SHUTTLE** ring clockwise.
 - 4 Turn the **JOG** dial to set the VCR address (from 000 to 127).
 - The address set appears on the digital display.
 - 5 Turn the **SHUTTLE** ring clockwise.
 - 6 Turn the **JOG** dial to set the data transfer speed (19200, 2400, 4800, 9600).
 - The data transfer speed set appears on the digital display.
 - 7 When finished, Press the **COUNTER RESET** button.

NOTE:

- When the **MENU RESET** button is pressed, the setting appearing on the digital display is reset to the default setting.

Settings when using RS-485

- 1 Press the **STANDBY/ON** button.
- 2 Press the **MENU** button to display the MAIN MENU.
- 3 Turn the **JOG** dial to select the "9.OTHERS" line, then turn the **SHUTTLE** ring clockwise.
 - The (OTHERS) menu appears.

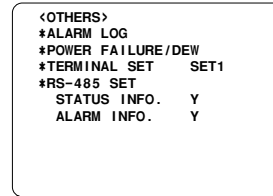

- 4 Turn the **JOG** dial until the "STATUS INFO." setting is highlighted, then turn the **SHUTTLE** ring clockwise.
- 5 Turn the **JOG** dial to set the "STATUS INFO." setting, then turn the **SHUTTLE** ring clockwise.
 - Y. The VCR status information is output at the RS-485 connector.
 - N The status information is not output at the RS-485 connector.
- 6 Turn the **JOG** dial until the "ALARM INFO." setting is highlighted, then turn the **SHUTTLE** ring clockwise.
- 7 Turn the **JOG** dial to set the "ALARM INFO." setting, then turn the **SHUTTLE** ring clockwise.
 - Y. The VCR alarm information (alarm recording start and stop) and video loss information are output at the RS-485 connector.
 - N The VCR alarm information (alarm recording start and stop) and video loss information are not output at the RS-485 connector.
- 8 Press the **MENU EXIT** button.
- 9 Set the **TERMINATE** switch on the back panel to the "ON" or "OFF" position
 - OFF side . . . Not terminated
 - ON side Terminated

NOTE:

- When a warning state (non-recording, mechanical problem or clog detection) occurs, the warning state is output from the RS-485 connector. However, non-recording warning states are not output if "NON REC" is set to "N" in the (WARNING OUT/CONTROL SET) menu. In addition, the clog detection warning state is not output if "CLOG DETECT." is set to "N" in the (GENERAL SET) menu.

CHECKING POWER FAILURE, FAILURE DUE TO CONDENSATION AND USAGE DURATION

- 1 Press the **STANDBY/ON** button.
- 2 Press the **MENU** button to display the MAIN MENU.
- 3 Turn the **JOG** dial to select the "9.OTHERS" line, then turn the **SHUTTLE** ring clockwise.
 - o *The (OTHERS) menu appears.*

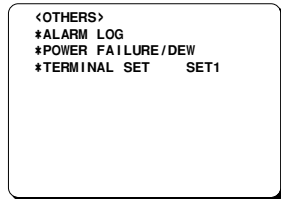

NOTE:

- If the **MENU RESET** button is pressed while the "POWER FAILURE" and "DEW" data is displayed, the data is erased. The "USED TIME" data cannot be reset. "P" will be erased from the digital display.

- 4 Turn the **JOG** dial to select the "POWER FAILURE/DEW" line, then turn the **SHUTTLE** ring clockwise.
 - o *The (POWER FAILURE/DEW/USED TIME) menu appears.*

Example

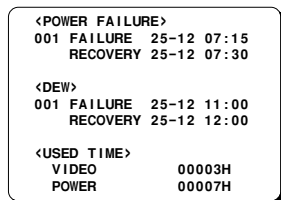

- POWER FAILURE The number of power failures, and the date and time of the most recent power failure and recovery are displayed.
- DEW The number of failures due to condensation, and the date and time of the most recent failure and recovery are displayed.
- USED TIME The video heads usage duration and the power on duration are displayed.

- 5 Press the **MENU EXIT** button.

OUTPUT TERMINALS

TAPE END OUT Terminal

- During recording, when the end of the tape is reached or when the tape counter reading indicates 3 hours, the output becomes 0V (Low). During autorepeat recording, the output becomes 0 V (Low) for about 2 seconds only.
- To reset the output, press the **STOP** or **EJECT** button.

TAPE END OUT Terminal Output Setting

- 1 Press the **STANDBY/ON** button.
- 2 Press the **MENU** button to display the MAIN MENU.
- 3 Turn the **JOG** dial to select the "5.ALARM/SERIES REC SET" line, then turn the **SHUTTLE** ring clockwise.
 - The (ALARM/SERIES REC SET) menu appears.

<ALARM/SERIES REC SET>	
*ALARM SET	
MODE	Y1
SPEED	3H
DURATION	20S
*1 SHOT SET	
FIELD	1
INTERVAL	1M
*SERIES REC	N
*TAPE END OUT	3:00

- 4 Turn the **JOG** dial until the "TAPE END OUT" setting is highlighted, then turn the **SHUTTLE** ring clockwise.
- 5 Turn the **JOG** dial to select the desired mode, then turn the **SHUTTLE** ring clockwise.
 - 3:00 The output becomes 0 V (Low) when the tape counter reaches "3H 00M 00S" and/or when the tape reaches the end.
 - END The output becomes 0 V (Low) when the tape reaches the end.

NOTES:

- If the "SERIES REC" is set to "Y" in the (ALARM/SERIES REC SET) menu, the output becomes 0 V (Low) for about 2 seconds when the counter reaches "3H 00M 00S", even if the "TAPE END OUT" is set to "END".
 - If the "SERIES REC" is set to "Y" in the (ALARM/SERIES REC SET) menu, the output becomes 0 V (Low) until 5 minutes have passed after the tape reaches the end.
- 6 Press the **MENU EXIT** button.

COM Terminal

- Common GND (ground) terminal when connecting other terminals to external devices.

TIMER OUT Terminal

- During timer recording, the output becomes 0 V.
- During timer recording stand-by mode, the output is 5 V (High).

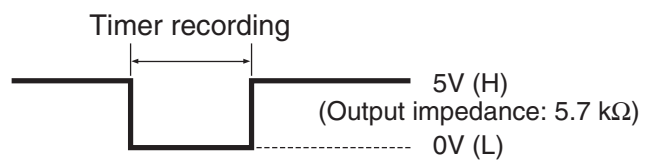

OUTPUT TERMINALS

SW OUT Terminal

When recording, a pulse signal is output at the **SW OUT** terminal.

This terminal is usually connected to the switch input (SW IN) of devices like a camera switcher unit, or a quad compressor.

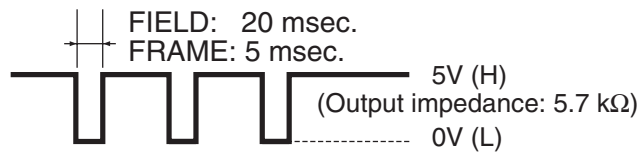

SW OUT Terminal Output Setting

- ① Press the **STANDBY/ON** button.
- ② Press the **MENU** button to display the MAIN MENU.
- ③ Turn the **JOG** dial to select the "2.DISPLAY/SW OUT SET" line, then turn the **SHUTTLE** ring clockwise.
 - The (DISPLAY/SW OUT SET) menu appears.

<DISPLAY SET>	SET UP
DATE	Y
TIME	Y
SPEED	Y
ALARM COUNT	Y
<SW OUT SET>	
TIMING	FIELD
FIELD	1
3H MODE	Y

- ④ Turn the **JOG** dial until the "TIMING" setting is highlighted, then turn the **SHUTTLE** ring clockwise.
- ⑤ Turn the **JOG** dial to select the desired output timing, then turn the **SHUTTLE** ring clockwise.
 - FIELD. 1 pulse is output after each set number of fields.
 - FRAME 1 pulse is output after each set number of frames.
- ⑥ Turn the **SHUTTLE** ring clockwise.
- ⑦ Turn the **JOG** dial to select the desired pulse signal interval (1, 2, 3, 4, 5, 10, 30 or 60), then turn the **SHUTTLE** ring clockwise.
 - If "TIMING" is set to FRAME (see step ⑤), "FRAME" will be indicated instead of "FIELD".
- ⑧ Turn the **SHUTTLE** ring clockwise.

- ⑨ Turn the **JOG** dial to select the desired "3H" mode, then turn the **SHUTTLE** ring clockwise.
 - Y. When recording in 3-hour mode, a pulse signal is output.
 - N. When recording in 3-hour mode, a pulse signal is not output.
- ⑩ Press the **MENU EXIT** button.

OUTPUT TERMINALS

WARNING OUT Terminal

- The **WARNING OUT** terminal output becomes 0 V (Low) in accordance with the (WARNING OUT/CONTROL SET) menu.

WARNING OUT Terminal Output Setting

- Press the **STANDBY/ON** button.
- Press the **MENU** button to display the MAIN MENU.
- Turn the **JOG** dial to select the "4. WARNING OUT/CONTR. SET" line, then turn the **SHUTTLE** ring clockwise.

o The (WARNING OUT/CONTROL SET) menu appears.

<WARNING OUT SET>SET UP	
ALARM	Y
NON REC	N
MECHA. PROBLEM	Y
VIDEO LOSS	Y
CLOG DETECT.	Y
<CONTROL SET>	
EJECT MODE	EJECT1
OPERATION	SLAVE

- Turn the **SHUTTLE** ring clockwise.
- Turn the **JOG** dial to select the desired mode, then turn the **SHUTTLE** ring clockwise.
 - SET UP Set each item
 - ALL Y To set all items to "Y"
 - ALL N To set all items to "N"
- If using the "SET UP" setting, continue with steps 6 to 8.
- Turn the **JOG** dial until the item for warning output is highlighted, then turn the **SHUTTLE** ring clockwise.
- Turn the **JOG** dial to set "Y" (warning is given) or "N" (warning is not given), then turn the **SHUTTLE** ring clockwise.

ALARM. The output becomes 0 V and "A" appears on the digital display during alarm recording

NON REC The output becomes 0 V and "N" appears on the digital display if the VCR enters a mode other than recording (i.e. recording pause, stop mode, etc.) during recording

MECHA. PROBLEM . . . The output becomes 0 V and "M" appears on the digital display when the tape stops or other problem with the internal mechanism

VIDEO LOSS The output becomes 0 V and "V" appears on the digital display when there is no video signal

CLOG DETECT. The output becomes 0 V and "C" appears on the digital display when the heads are dirty and the recording quality deteriorates

- Repeat steps 6 and 7 when setting other items.
- When finished, press the **MENU EXIT** button.

NOTES:

- The "VIDEO LOSS" line does not appear if "VIDEO LOSS" is set to "N" in the (GENERAL SET) menu.
- The "CLOG DETECT." line does not appear if "CLOG DETECT." is set to "N" in the (GENERAL SET) menu.
- Displays on the digital display take precedence over other displays.
- Canceling warning displays and output.
 - Press the **STOP** button once. The warning display disappears from the digital display.
 - Press the **STOP** button once more. If "MECHA. PROBLEM" or "CLOG DETECT." warnings are being output, then output stops.
- If the "NON REC", "VIDEO LOSS" or "ALARM" warning is being output, the condition immediately before the warning output is restored and the output stops.
- If the system has shut down because of a "MECHA. PROBLEM" warning, the output is canceled when the **ALL RESET** button is pressed.

OUTPUT TERMINALS

REMOTE Jack

Remote control of the VCR is possible by connecting a remote controller with a circuit such as indicated below, to the **REMOTE** jack.

NOTES:

- Use a 3.5 mm mini-jack type plug.
- The connection should be done using a shielded cable no more than 5 meters long.
- The functions not available on the VCR will not operate.
- You can use a VA-RMN01 Remote Control Unit (sold separately) to control the VCR remotely. The functions not available on the VCR will not operate.

Remote control circuit

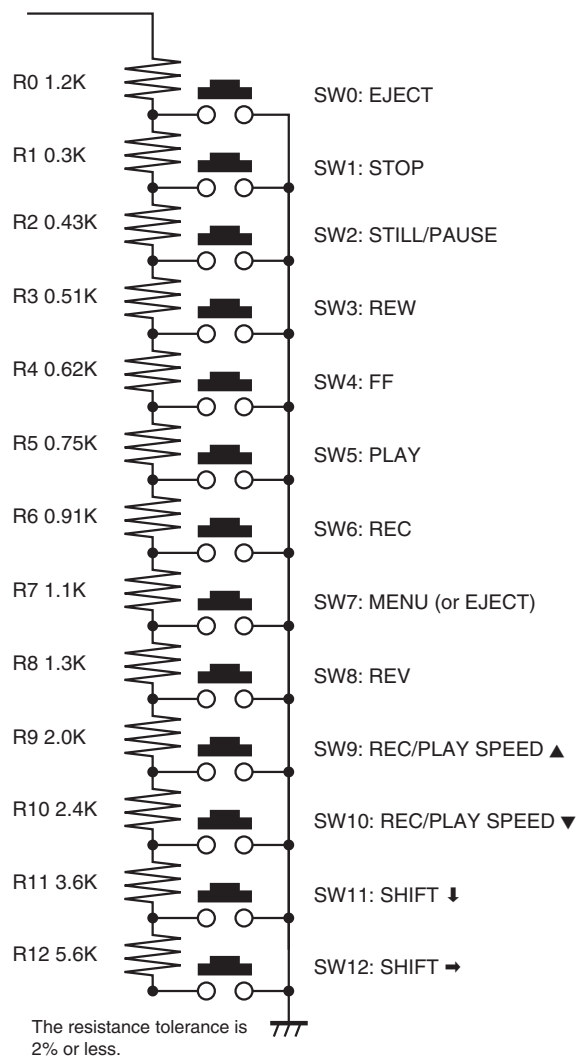

Remote control setting

The remote control switch 7 (see illustration at left) can be set to either eject the tape or access the menus.

- 1 Press the **STANDBY/ON** button.
- 2 Press the **MENU** button to display the MAIN MENU.
- 3 Turn the **JOG** dial to select the "3.GENERAL SET" line, then turn the **SHUTTLE** ring clockwise.
 - The (GENERAL SET) menu appears.

<GENERAL SET>	
TAPE IN MODE	STOP
TAPE END MODE	REW
CLOCK ADJUST	01:00
THREAD CHECK	N
VIDEO LOSS	N
CLOG DETECT.	N
REMOTE	MENU
VIDEO	COLOR

- 4 Turn the **JOG** dial until the "REMOTE" setting is highlighted, then turn the **SHUTTLE** ring clockwise.
- 5 Turn the **JOG** dial to select the desired switch mode, then turn the **SHUTTLE** ring clockwise.
 - MENU Switch operates as an **MENU** button
 - EJECT Switch operates as an **EJECT** button
- 6 Press the **MENU EXIT** button.

HEAD SWITCHING FUNCTION

This unit is equipped with 4 double azimuth heads. Under normal conditions, recording and playback is done using the main heads "A1" and "B1".

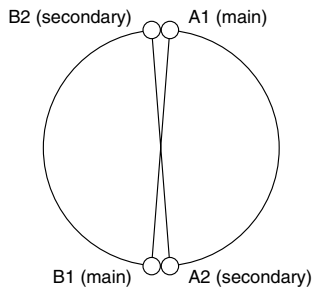

If a problem occurs with the main heads, for example if only one channel is being recorded and playback cannot be done, you can temporarily switch to the secondary heads so that the playback picture can be viewed.

(If a problem occurs with the main heads, it is recommended that you have the unit repaired as soon as possible.)

Switching heads combination and azimuth display

The heads that are used can be switched to any of the combinations (①, ② or ③) indicated in the table below, until the playback picture can be viewed. When switching to a combination other than the main heads, the corresponding azimuth indicator will be displayed.

- ① Start playback.
- ② Press and hold the **MENU** button, then press the **PLAY** button.
- ③ Release the button.
 - The selected heads combination will change in the order indicated in the table below.

To select another head combination, repeat steps ② and ③ above.

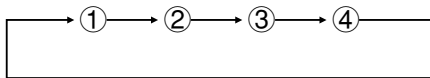

	Heads combination	Azimuth indicator
①	A1 and A2	+
②	B1 and B2	-
③	A2 and B2	1
④	A1 and B1	No indicator (Normal head combination)

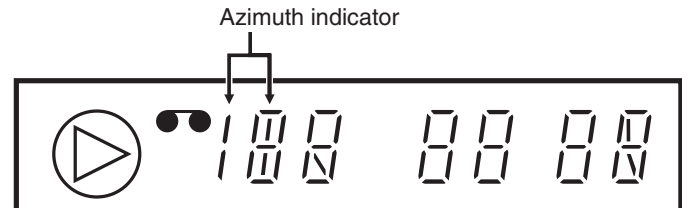

NOTES:

- When the end of the tape is reached, the head combination automatically returns to the normal setting. The head combination will also automatically return to the normal setting when the tape is stopped, the cassette is ejected or after a power interruption.
- When using the head combination ① or ② during playback, note the following points.

3-hour mode

The image is close to normal, but there will be some shaking in the vertical direction.

12 or 24-hour mode

Noise bars will be visible

48 - 960-hour mode

Noise bars will appear and disappear

Field advance

Noise bars will appear and disappear

MAINTENANCE

Daily Inspection

The following daily inspections are recommended in order to assure long-term and trouble-free operation of the unit.

The daily inspections are particularly important if using autorepeat recording.

Inspection Procedure

- ❶ Turn on the power to the VCR, camera, TV monitor and other connected devices.
- ❷ Check that the image received on the TV monitor is correct.
- ❸ Check that the on-screen display of the date and time is correct.
- ❹ To check the recording condition of the previous day, rewind the recorded tape a few seconds.
- ❺ Press the **PLAY** button and check that the playback image is correct.
- ❻ Check that the recorded date and time are correct.

NOTES:

- If the security lock is engaged, it has to be released before proceeding to the inspection.
- If any problem is discovered during the inspection, turn off the VCR, unplug the power cord then consult your dealer.

Periodic Inspection

Periodic inspection and maintenance should be referred to your dealer.

If there is noise in the playback picture, and it cannot be corrected using the tracking control, it may indicate that the video heads need cleaning.

Soiling is unlikely, thanks to the automatic head cleaning function, but due to factors such as the use of poor quality tape and the usage environment the heads could become dirty in a short time.

The video heads should be inspected every 1,000 hours of use to determine if they need to be replaced.

The video heads usage can be checked using the (POWER FAILURE/DEW/USED TIME) menu.

Cabinet Cleaning

Clean the outside of the cabinet with a clean, soft cloth, moistened with lukewarm water and wrung dry.

DO NOT USE SOLVENTS OR OTHER TYPES OF CLEANERS. THESE CHEMICALS CAN CRACK OR DISCOLOR THE CABINET.

About the Backup Battery

The date and time settings are maintained for up to 30 days by a rechargeable lithium battery that is fully charged after the VCR has been connected to a power source for 48 hours or more.

Depending on the battery usage it may become necessary to change it. For replacement and disposal of the old battery, please contact your dealer.

After the battery has been replaced, press the **ALL RESET** button, then enter all the time, date, etc. settings as required.

Automatic Head Cleaning Function

- Whenever a video cassette is loaded or ejected, the video heads are automatically cleaned.
- During autorepeat recording, the video heads are automatically cleaned when the tape reaches the end.

MAINTENANCE

Maintaining and Checking The Mechanism

To maintain the VCR functions and features working properly, and to avoid damages or dirt on the tape, it is recommended to follow the maintenance points and periodicity indicated below.

For detailed information, please contact your dealer.

Maintenance Table

○ : Cleaning ⊙ : Confirmation △ : Lubrication □ : Change

	PARTS	2000H	4000H	6000H	8000H	NOTES	
Tape Path System	ASSY, BRAKE BAND	⊙	□	⊙	□		
	ASSY, LEVER BT (tape guide)	○	○	○	○		
	FULL ERASE HEAD	○	○	○	□		
	ASSY, ROLLER CLEANER	⊙	□	⊙	□		
	ASSY, GUIDE ROLLER	○	○	○	○		
	ASSY, MOUNTING INCLNE S	○	○	○	□		
	ASSY, MOUNTING INCLNE T	○	○	○	□		
	ACE HEAD	○	○	○	□		
	ASSY, LEVER PINCH ROLLER	○	□	○	□		
	MOUNTING, LIFT PINCH				□		
	CAM, LIFT PINCH				□		
	GEAR, CAM PINCH				□		
	EARTH CHIP CYLINDER				□		
	COMPL, CYLINDER	○	○(□)	○	○(□)		
	ASSY, CYLINDER UPPER	○(□)	○(□)	○(□)	○(□)		
Reel Drive System	ASSY, REEL SUPPLY	○△	○△	○△	○△		
	ASSY, REEL TAKEUP	○△	○△	○△	○△		
	GEAR, REEL S	△	△	△	△		
	GEAR, REEL T	△	△	△	△		
	PULLEY, REEL	△	△	△	△		
	SPECIAL, WASHER 2.4 X 6 X 0.25		⊙		⊙		
	COMPL, MOUNTING CLUTCH	△	□	△	□		
	BELT, REEL	⊙	□		□		
	MOTOR, CAPSTAN	○	⊙(□)	⊙(□)	□		
	ASSY, GEAR FRICTION	△	△□	△	△□		
	Brake	ASSY, BRAKE S	⊙	⊙	⊙	⊙	
		ASSY, BRAKE T	⊙	⊙	⊙	⊙	
ASSY, BRAKE CAPSTAN		⊙	⊙	⊙	⊙		
ASSY, BRAKE SOFT T			⊙		□		
Loading Drive System	ASSY, LOADING MOTOR		⊙		□		
	DAMPER				□		
	COMPL, GEAR WORM		⊙		□		
	CAM, MAIN				□		
	SPECIAL WASHER 3.6 X 0.5		⊙		□		
	GEAR, WHEEL 1				□		
	GEAR, WHEEL 2		⊙		□		
	GEAR RELAY PINCH OPT				□		
	SLIDE, CRECENT		⊙		□		
	GEAR, LOAD S		⊙		□		
	GEAR, RACK FRONT		⊙		□		
GEAR, RACK START		⊙		□			
GEAR, PINON		⊙		□			
Performance Check	BACK TENSION TORQUE	⊙	⊙	⊙	⊙	PB BACK TENSION TORQUE 25~50g·cm	
	FWD, REW TORQUE	⊙	⊙	⊙	⊙	FWD, REW TORQUE ≥ 600g·cm	
	PLAY TORQUE	⊙	⊙	⊙	⊙	PLAY 55 ~ 110g·cm	
	REV TORQUE	⊙	⊙	⊙	⊙	REV 100 ~ 210g·cm	

NOTES:

- This table shows the maintenance for up to 8000 hours. After this, repeat from the start of the table.
- For places with symbols such as ⊙ (□) and ○ (□), carry out checking and cleaning, and replace if necessary.
- This periodic maintenance check table changes considerably according to the using conditions and environment.
- Refer to the (POWER FAILURE/DEW/USED TIME) menu for the length of time the unit has been used.
- As the life of parts may be shortened if foreign particles and dusts remain accumulated on the tape guides and rotating and contacting portions, clean if dirty.
- Dusts and other foreign particles on the tape guides may also shorten the tape life and lower picture quality, therefore clean thoroughly.

TROUBLESHOOTING GUIDE

If the unit does not operate normally when you follow the instructions indicated in the manual, please refer to the table below.

SYMPTOM	POSSIBLE CAUSE	CORRECTIVE ACTION
No power	The power cord is not connected	Connect the power cord
No image displayed on the TV monitor	The connections are not correct	Check that all connections are correct
	The power to the camera and/or TV monitor is not turned on	Turn all connected devices power on
The buttons do not respond	A cassette tape is not loaded	Load a cassette and turn the power on
	All functions are suspended due to condensation	Wait for the "dd dd" indicator to go off
	Alarm recording	Wait for the alarm recording to end
	Unit in menu mode	Press the MENU EXIT button.
	The security lock is engaged	Cancel the security lock
Recording is not possible (the tape is ejected)	The loaded cassette has no erasure-prevention tab	Load a cassette tape with an erasure-prevention tab or cover the tab hole with adhesive tape
Recording is not possible (Tape rewinds)	"Y" is selected for the tape management	Normally. Refer to "TAPE MANAGEMENT" on page 16.
Autorepeat recording is not possible	"AL" appears on the digital display	Display (ALARM LOG) menu, then press the MENU RESET button to turn off the "AL" indicator
Timer recording is not possible	The date and time are not set correctly	Set the date and time correctly
	The unit is not set to timer recording stand-by mode	Press the TIMER button to display "□" on the digital display
	"N" is selected for the timer recordings	Be sure to select "Y" for the programmed timer recordings
Alarm recording is not possible	"OFF" appears on the digital display	Press the EJECT, STOP or PLAY button or turn the SHUTTLE ring to turn the indicator off
Noise in the playback picture	The video heads need cleaning	Clean the video heads
The date and time are not recorded	Display mode not set.	Press the ON SCREEN button to display and record the date and time.
"O" flashes.	The heads are dirty (see page 21).	Clean the heads.
The cassette tape cannot be ejected	Problem with the system	Unplug the power cord then plug it back in
The cassette is ejected a few seconds after it has been inserted	The tape is not threaded correctly	Try inserting the cassette one more time or using a new cassette. If it is ejected again, please consult your dealer.

After a Power Failure

If the recording speed is reset to 3-hour mode after a power failure, it is due to insufficient backup battery charge. This is not a malfunction.

System Down

If the unit does not function at all, try the following.

- ❶ Unplug the power cord then plug it back in.
- ❷ Reset the memory. (Press the **ALL RESET** button. Under normal conditions, do not touch the **ALL RESET** button.)
The time and date will be reset, and the quick method security lock will be canceled.
- ❸ If the problem is not corrected after performing steps ❶ and ❷ a few times, consult your dealer.

SPECIFICATIONS

General Specifications

Video head system	Dual-azimuth 4-head rotating helical scanning system: Dual azimuth 2-head for record and standard playback Dual azimuth 4-head for forward picture search, reverse picture search and still mode
Audio recording	In 3-, 12- and 24-hour modes (when using E-180 tape)
Tape speed	23.39 mm /sec (3-hour mode)
Specified video cassette tape	VHS 1/2 inch video cassette tape
Recording/playback time (TLS-1960P only)	3, 12, 24, 48, 72, 96, 120, 168, 240, 360, 480, 720 and 960 hours (when using E-180 tape)
Recording/playback time (TLS-9924P only)	3, 12 and 24 hours (when using E-180 tape)
Fast forward/rewind time	approximately 2 minutes (when using E-180 tape)
Television system	PAL colour TV system

Video

Recording method	Luminance signal: FM recording Chrominance signal: Down-converted direct recording
Video input	1 V(p-p), BNC, 75 Ω , unbalanced
Video output	1 V(p-p), BNC, 75 Ω , unbalanced
Horizontal resolution	Black & white mode 350 line or more Colour mode 250 line or more

Audio

Input	-8 dBs, RCA pin jack, 27 k Ω , unbalanced
Output	-8 dBs, RCA pin jack, 600 Ω , unbalanced
Microphone input	-60 dBs, 3.5 mm mini jack, 10 k Ω , unbalanced

Connectors

Alarm (1 shot) input	No voltage, make-contact switch input (Low input 100ms or more, Normally 5 V)
Control input	Key code (pulse signal) (Normally 5 V)
Series input	No voltage, make-contact switch input (Low input 1s or more, Normally 5 V)
Ext timer (alarm reset) input	No voltage, make-contact switch input (Low input 100ms or more, Normally 5 V)
Common	0 V (GND)
Warning output	Open collector Max. 500 mA (Active Low 0 V, Normally open)
Control output	Key code (pulse signal) (Normally 5 V)
Tape end output	Open collector Max. 50 mA (Active Low 0 V, Normally open)
Timer output	DC 5 V, 5.7k Ω , (Low output)
Switch output	Pulse signal (Normally 5 V)
DC 12-24V "+" input (TLS-1960P only)	DC 12 to 24V
DC 12-24V "-" input (TLS-1960P only)	DC 0 V
Remote control input	3.5 mm mini jack

SPECIFICATIONS

Other Specifications

Operating temperature range	5°C to 40°C (41°F to 104°F)
Operating humidity range	80% or less
Power requirements (TLS-1960P only)	220-240V AC, 50Hz (or DC power: 12 to 24V DC)
Power requirements (TLS-9924P only)	220-240V AC, 50Hz
Power consumption	15 W
Dimensions (W x H x D)	420 mm x 99.5 mm x 306 mm
Weight (TLS-1960P only)	approximately 4.2 kg
Weight (TLS-9924P only)	approximately 4.0 kg

Connectors (When the "TERMINAL SET" is set to "SET2")

NOTES:

- The terminal names and signals are different from the usual setting.
- Names in brackets apply to terminals on the rear panel.

Clock set input (CONTROL IN)	No voltage, make-contact switch input (Low input 100ms or more, Normally 5 V)
Clock set output (CONTROL OUT)	DC 5 V, 5.7k Ω , (Low output)
Eject input (SERIES IN)	No voltage, make-contact switch input (Low input 100ms or more, Normally 5 V)
Eject output (TIMER OUT)	DC 5 V, 5.7k Ω , (Low output)

NOTE: The specifications and external appearance of this unit are subject to change without notice.

Free Manuals Download Website

<http://myh66.com>

<http://usermanuals.us>

<http://www.somanuals.com>

<http://www.4manuals.cc>

<http://www.manual-lib.com>

<http://www.404manual.com>

<http://www.luxmanual.com>

<http://aubethermostatmanual.com>

Golf course search by state

<http://golfingnear.com>

Email search by domain

<http://emailbydomain.com>

Auto manuals search

<http://auto.somanuals.com>

TV manuals search

<http://tv.somanuals.com>