



**INSTRUCTION MANUAL**

**MCO-19M(UVH)  
MCO-19M(UV)  
MCO-19M**

**Multi Gas Incubator**



# CONTENTS

INTRODUCTION	P. 3
PRECAUTIONS FOR SAFE OPERATION	P. 4
LABELS ON THE INCUBATOR	P. 8
ENVIRONMENTAL CONDITIONS	P. 8
INCUBATOR COMPONENTS	P. 9
Control panel and keypad	P. 12
Remote alarm terminals	P. 13
INSTALLATION SITE	P. 14
INSTALLATION	P. 15
Connection of CO <sub>2</sub> gas cylinder	P. 16
Connection of N <sub>2</sub> (or O <sub>2</sub> ) gas cylinder	P. 17
Connection of gas injection nozzle	P. 18
Using the inner door and gastight split doors	P. 18
PREVENTING CONTAMINATION	P. 19
PRECAUTIONS FOR CULTURES	P. 20
Using the unlock key	P. 21
CORRECT OPERATION	P. 21
LCD PANEL	P. 22
BASIC OPERATIONS ON CONTROL PANEL	P. 24
BASIC PARAMETERS	
Setting the chamber temperature, CO <sub>2</sub> and CO <sub>2</sub> density	P. 25
Setting the key lock	P. 26
Releasing the key lock	P. 27
Setting the key lock password	P. 28
Automatic N <sub>2</sub> (or O <sub>2</sub> ) gas cylinder changeover	P. 30
Setting the upper limit alarm temperature	P. 32
ALARM PARAMETERS	P. 33
UV LAMP PARAMETERS	P. 34
Using the UV lamp	P. 34
Precautions when using the UV lamp	P. 35
Setting the UV lamp ON period	P. 36
Lighting the UV lamp for 24 hours	P. 37
OTHER PARAMETERS	
Setting the date, time, and log interval	P. 38
Initial settings (LCD/DAQ parameters)	P. 40
DISPLAYING THE LOG	P. 41
Transferring data	P. 43
WATER LEVEL SENSOR	P. 44
ROUTINE MAINTENANCE	
Cleaning the chamber and inner attachments	P. 45
Filling the humidifying pan	P. 48
H <sub>2</sub> O <sub>2</sub> DECONTAMINATION	P. 49
H <sub>2</sub> O <sub>2</sub> decontamination	P. 51
Precautions when handling H <sub>2</sub> O <sub>2</sub> decontamination reagent	P. 54
ALARMS, SAFETY, AND SELF-DIAGNOSIS	P. 55
CALIBRATION	
Temperature/CO <sub>2</sub> /O <sub>2</sub> calibration	P. 58
TROUBLESHOOTING	P. 60
DISPOSING OF THE MULTI-GAS INCUBATOR	P. 62
AUTOMATIC CO <sub>2</sub> CYLINDER CHANGEOVER	P. 67
AUTOMATIC CO <sub>2</sub> AND O <sub>2</sub> DENSITY CALIBRATION	P. 69
STACKING INCUBATORS	P. 72

# CONTENTS

SPECIFICATIONS	P. 74
PERFORMANCE	P. 75
SAFETY CHECK SHEET	P. 76

# INTRODUCTION

- Read this manual carefully before using the Product and follow the instructions for safety operation.
- Sanyo disavows any responsibility for safety if the Product is used for other than the intended use or used with any procedures other than those given in this manual.
- Keep this manual in a suitable place so that it can be referred to as necessary.
- The contents of this manual are subject to change without notice for improvement of performance or functions.
- Contact a Sanyo sales representative or agent if any page of the manual is lost or the page order is incorrect.
- Contact a Sanyo sales representative or agent if any point in this manual is unclear or if there are any inaccuracies.
- No part of this manual may be reproduced in any form without the expressed written permission of Sanyo.

## CAUTION

SANYO guarantees the product under certain warranty conditions. SANYO in no way shall be responsible for any loss of content or damage of content.

# PRECAUTIONS FOR SAFE OPERATION

**It is imperative that the user complies with this manual as it contains important safety advice.**

Items and procedures are described so that you can use this unit correctly and safely. If the precautions advised are followed, this will prevent possible injury to the user and any other person.

Precautions are illustrated in the following way:



## **WARNING**

Failure to observe WARNING signs could result in a hazard to personnel possibly resulting in serious injury or death.

## **CAUTION**

Failure to observe CAUTION signs could result in injury to personnel and damage to the unit and associated property.

Symbol shows;

-  this symbol means caution.
-  this symbol means an action is prohibited.
-  this symbol means an instruction must be followed.

Be sure to keep this manual in a place accessible to users of this unit.

< Label on the unit >















This mark is labeled on the cover in which the electrical components of high voltage are enclosed to prevent the electric shock.

The cover should be removed by a qualified engineer or a service personnel only.

















## **WARNING**

As with any equipment that uses CO<sub>2</sub> gas, there is a likelihood of oxygen depletion in the vicinity of the equipment. It is important that you assess the work site to ensure there is suitable and sufficient ventilation. If restricted ventilation is suspected, then other methods of ensuring a safe environment must be considered. These may include atmosphere monitoring and warning devices.











# **WARNING**

-  **Do not use the unit outdoors.** Current leakage or electric shock may result if the unit is exposed to rain water.
-  **Only qualified engineers or service personnel should install the unit.** The installation by unqualified personnel may cause electric shock or fire.
-  **Install the unit on a sturdy floor and take an adequate precaution to prevent the unit from turning over.** If the floor is not strong enough or the installation site is not adequate, this may result in injury from the unit falling or tipping over.
-  **Never install the unit in a humid place or a place where it is likely to be splashed by water.** Deterioration of the insulation may result which could cause current leakage or electric shock.
-  **Never install the unit in a flammable or volatile location.** This may cause explosion or fire.
-  **Never install the unit where acid or corrosive gases are present** as current leakage or electric shock may result due to corrosion.
-  **Always ground (earth) the unit to prevent electric shock.** If the power supply outlet is not grounded, it will be necessary to install a ground by qualified engineers.
-  **Never ground the unit through a gas pipe, water main, telephone line or lightning rod.** Such grounding may cause electric shock in the case of an incomplete circuit.
-  **Connect the unit to a power source as indicated on the rating label attached to the unit.** Use of any other voltage or frequency other than that on the rating label may cause fire or electric shock.
-  **Never store volatile or flammable substances** in this unit if the container cannot be sealed. These may cause explosion or fire.
-  **Do not insert metal objects such as a pin or a wire into any vent, gap or any outlet on the unit.** This may cause electric shock or injury by accidental contact with moving parts.
-  **Use this unit in safe area when treating the poison, harmful or radiate articles.** Improper use may cause bad effect on your health or environment.
-  **Turn off the power switch (if provided) and disconnect the power supply to the unit prior to any repair or maintenance** of the unit in order to prevent electric shock or injury.
-  **Do not touch any electrical parts (such as power supply plug) or operate switches with a wet hand.** This may cause electric shock.

# **WARNING**

-  **Ensure you do not inhale or consume medication or aerosols** from around the unit at the time of maintenance. These may be harmful to your health.
-  **Never splash water directly onto the unit** as this may cause electric shock or short circuit.
-  **Never put containers with liquid on the unit** as this may cause electric shock or short circuit when the liquid is spilled.
-  **Never bind, process, or step on the power supply cord, or never damage or break the power supply plug.** A broken supply cord or plug may cause fire or electric shock.
-  **Do not use the supply cord if its plug is loose.** Such supply cord may cause fire or electric shock.
-  **Never disassemble, repair, or modify the unit yourself.** Any such work carried out by an unauthorized person may result in fire, or electric shock or injury due to a malfunction.
-  **Disconnect the power supply plug if there is something wrong with the unit.** Continued abnormal operation may cause electric shock or fire.
-  **When removing the plug from the power supply outlet, grip the power supply plug, not the cord.** Pulling the cord may result in electric shock or fire by short circuit.
-  **Disconnect the power supply plug** before moving the unit. Take care not to damage the power cord. A damaged cord may cause electric shock or fire.
-  **Disconnect the power plug when the unit is not used for long periods.** Keeping the connection may cause electric shock, current leakage, or fire due to the deterioration of insulation.
-  If the unit is to be stored unused in an unsupervised area for an extended period, **ensure that children do not have access and that doors cannot be closed completely.**
-  **The disposal of the unit should be accomplished by appropriate personnel.** Remove doors to prevent accidents such as suffocation.
-  **Do not put the packing plastic bag within reach of children** as suffocation may result.
-  **Use the reagent specified by Sanyo for H<sub>2</sub>O<sub>2</sub> decontamination.** Using a different H<sub>2</sub>O<sub>2</sub> solution may result in explosion or damage to the Incubator.
-  When performing H<sub>2</sub>O<sub>2</sub> decontamination, **securely close gastight split doors, inner door and outer door.** Failure to do so may be harmful to health due to leakage of H<sub>2</sub>O<sub>2</sub> gas.
-  During H<sub>2</sub>O<sub>2</sub> decontamination, **plug the access hole with the silicon cap that is provided.** Failure to do so may be harmful to health due to leakage of H<sub>2</sub>O<sub>2</sub> gas.





# CAUTION

-  **Use a dedicated power source** (a dedicated circuit with a breaker) as indicated on the rating label attached to the unit. A branched circuit may cause fire resulting from abnormal heating.
-  **Connect the power supply plug to the power source firmly after removing the dust on the plug.** A dusty plug or improper insertion may cause a heat or ignition.
-  **Never store corrosive substances such as acid or alkali** in this unit if the container cannot be sealed. These may cause corrosion of inner components or electric parts.
-  **Check the setting when starting up of operation after power failure or turning off of power switch.** The stored items may be damaged due to the change of setting.
-  **Be careful not to tip over the unit** during movement to prevent damage or injury.
-  **Prepare a safety check sheet** when you request any repair or maintenance for the safety of service personnel.
-  **Wear rubber gloves when handling the H<sub>2</sub>O<sub>2</sub> reagent.** Direct contact with the H<sub>2</sub>O<sub>2</sub> reagent may result in inflammation of the skin.
-  H<sub>2</sub>O<sub>2</sub> decontamination can be performed only for the chamber and chamber attachments with standard specifications, and not for any other objects.
-  **Perform H<sub>2</sub>O<sub>2</sub> decontamination with the chamber attachments arranged as specified by Sanyo.** Arranging them in a different way may result in insufficient decontamination.
-  After H<sub>2</sub>O<sub>2</sub> decontamination has been completed, **wear rubber gloves and use a non-woven cloth to wipe off the residual H<sub>2</sub>O<sub>2</sub> fluid from the bottom of the chamber, any objects that were decontaminated, and the bottoms of ducts.**



# LABELS ON THE INCUBATOR

Warning and caution labels are attached to the Incubator. The following table describes the labels.

	This label is attached to covers that access high-voltage electrical components to prevent electric shock. Only a qualified engineer or service personnel should be allowed to open these covers.
	This symbol indicates an ultraviolet light (UV) caution.
	This symbol indicates that caution is required. Refer to product documentation for details.
	This symbol indicates a hot surface.
	This symbol indicates an earth.
	This symbol means "ON" for a power switch.
○	This symbol means "OFF" for a power switch.

# ENVIRONMENTAL CONDITIONS

This equipment is designed to be safe at least under the following conditions (based on the IEC 61010-1):

- Indoor use;
- Altitude up to 2000 m;
- Ambient temperature 5°C to 40°C
- Maximum relative humidity 80% for temperature up to 31°C decreasing linearly to 50% relative humidity at 40°C;
- Mains supply voltage fluctuations not to exceed  $\pm 10\%$  of the nominal voltage;
- Other supply voltage fluctuations as stated by the manufacturer;
- Transient overvoltages according to Installation Categories (Overvoltage Categories) II; For mains supply the minimum and normal category is II;
- Pollution degree 2 in accordance with IEC 60664.

# INCUBATOR COMPONENTS

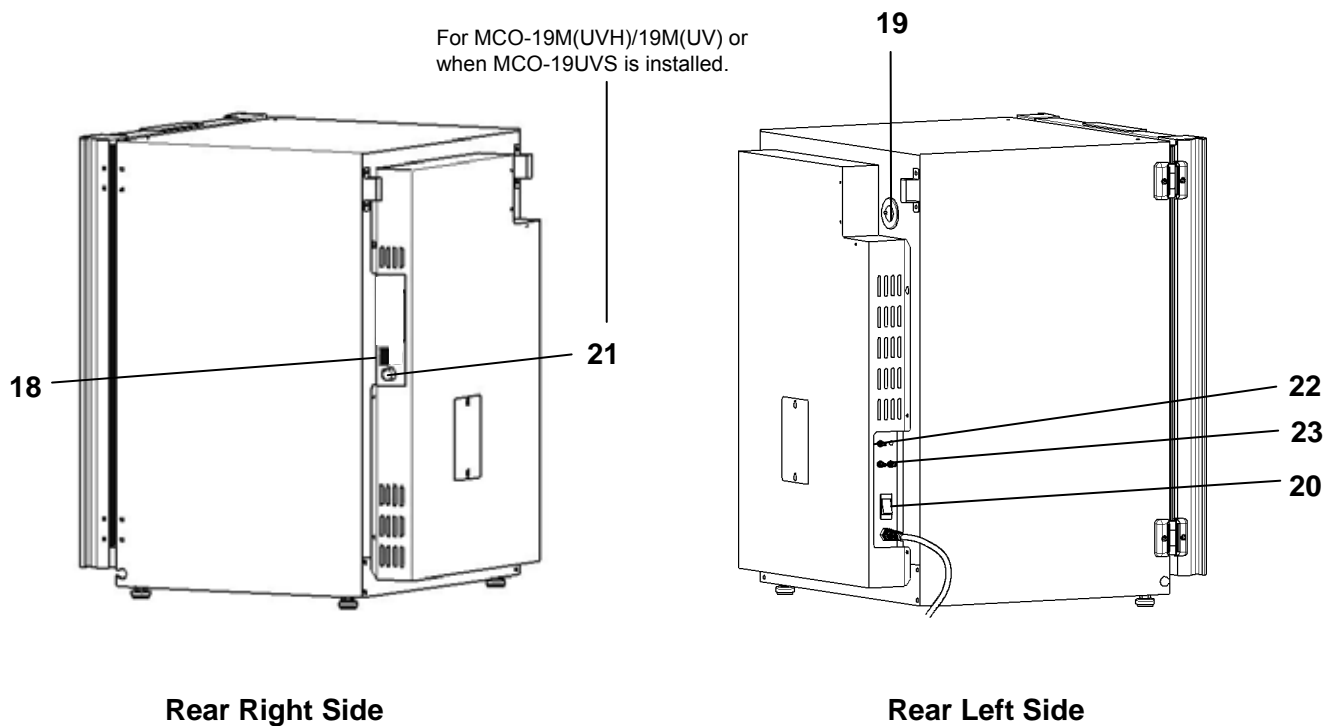
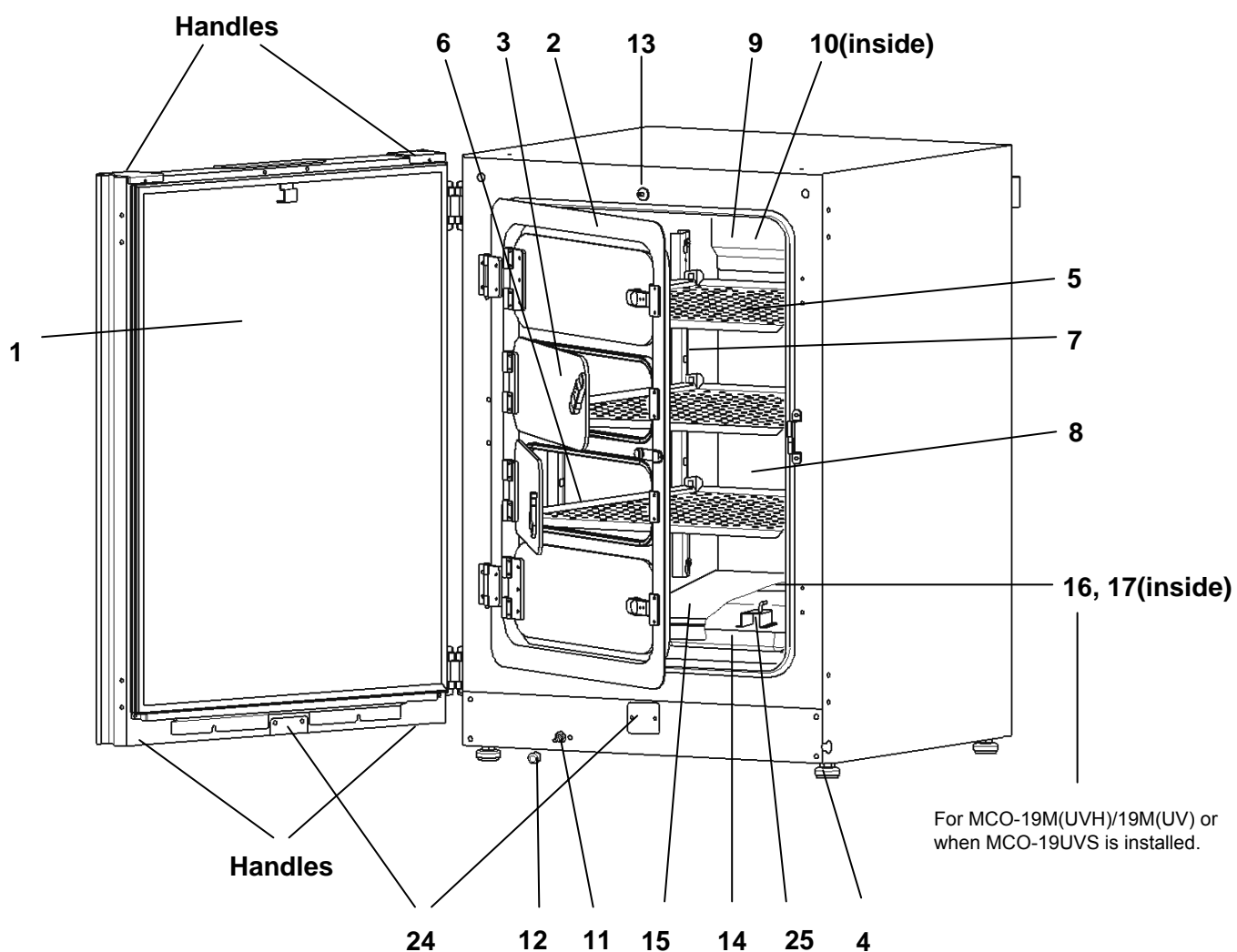

- 1. Outer door:** The outer door is held to the frame with a magnetic seal. A door heater is installed in the door panel. The door opening is reversible. Contact a Sanyo representative or agent to change the door hinge from left to right or vice versa.
- 2. Inner door:** Open when take the trays out or clean inside.
- 3. Gastight split door:** Made of tempered glass, however avoid excessive impact on the glass.
- 4. Leveling feet:** The leveling feet can be turned to adjust the height. Adjust the feet so that the Incubator is level.
- 5. Trays:** Set trays at the same level as each gastight split door. Open a inner door when take the tray out.
- 6. Tray supports:** The tray supports can be removed by lifting the front side and pulling toward you.
- 7. Side supports:** The right and left side supports can be removed for disinfection. Refer to page 45.
- 8. Duct:** The duct for the path for circulating air. It is removable.
- 9. Fan cover:** The fan cover serves as the inlet for circulating air. It is removable.
- 10. Fan (inside the duct):** The fan is made from polypropylene resin. It can be disinfected in an autoclave.
- 11. Sample air outlet:** The sample air outlet also functions as an internal gas outlet. Normally, cover this outlet with the sample air outlet cap.
- 12. Sample air outlet cap:** Always attach this cap except when using the sample air outlet.
- 13. Door switch:** Detects the door opening/closing and stops the circulating fan and electromagnetic valve for CO<sub>2</sub> and N<sub>2</sub>/O<sub>2</sub> when door is open. UV lamp is also deactivated by door opening\*.
- 14. Humidifying pan:** Fill the humidifying pan with sterile distilled water. Install the pan properly so that it can be covered with the pan cover.
- 15. Humidifying pan cover:** The cover prevents UV light entering the chamber. When filling the pan, lift the front side and take out the pan. Refer to page 48 for details.
- 16. UV lamp\*:** This Sanyo UV lamp does not generate ozone. Never look directly at the UV light. For replacement, contact a Sanyo representative or agent.
- 17. Water level sensor for humidifying pan:** This sensor detects the water level in the humidifying pan. Refer to page 44 for details.
- 18. Remote alarm terminals:** Refer to page 13.
- 19. Access port:** Place the silicon caps on the port both outside and inside when the port is not being used.
- 20. Power switch:** This is the main switch for the Incubator. It also functions as an overcurrent breaker.
- 21. Glow starter\*:** The glow started if for the UV lamp (model FG-7P)
- 22. Connecting port A/B for CO<sub>2</sub> gas pipe:** When the optional MCO-21GC Automatic CO<sub>2</sub> Cylinder Changeover System is installed, both ports A and B are available. If the MCO-21GC is not installed, only port A is available. Refer to page 16 for gas cylinder connection. Ensure that the gas pressure is set at 0.03 MPaG (0.3 kgf/cm<sup>2</sup>G, 4.3 psiG). Refer to page 67 for automatic CO<sub>2</sub> cylinder changeover.

---

**23. Connecting port A/B for N<sub>2</sub>/O<sub>2</sub> gas pipe:** Refer to page 17 for gas cylinder connection. Ensure that the gas pressure is set at 0.05 MPaG (0.5 kgf/cm<sup>2</sup>G, 7.1 psiG). Refer to page 30 for automatic N<sub>2</sub> (or O<sub>2</sub>) gas cylinder changeover.

**24. Attachment location for electric key:** This is the attachment location for the electric key included in the optional Component H<sub>2</sub>O<sub>2</sub> Decontamination Kit (MCO-HL). This kit must be attached to perform H<sub>2</sub>O<sub>2</sub> decontamination. Refer to the installation procedure for MCO-HL for details.

**25. Gas injection nozzle**

\* MCO-19M(UVH)/19M(UV) or when an optional UV System Kit (MCO-19UVS) is installed.\*

# Control panel and keypad

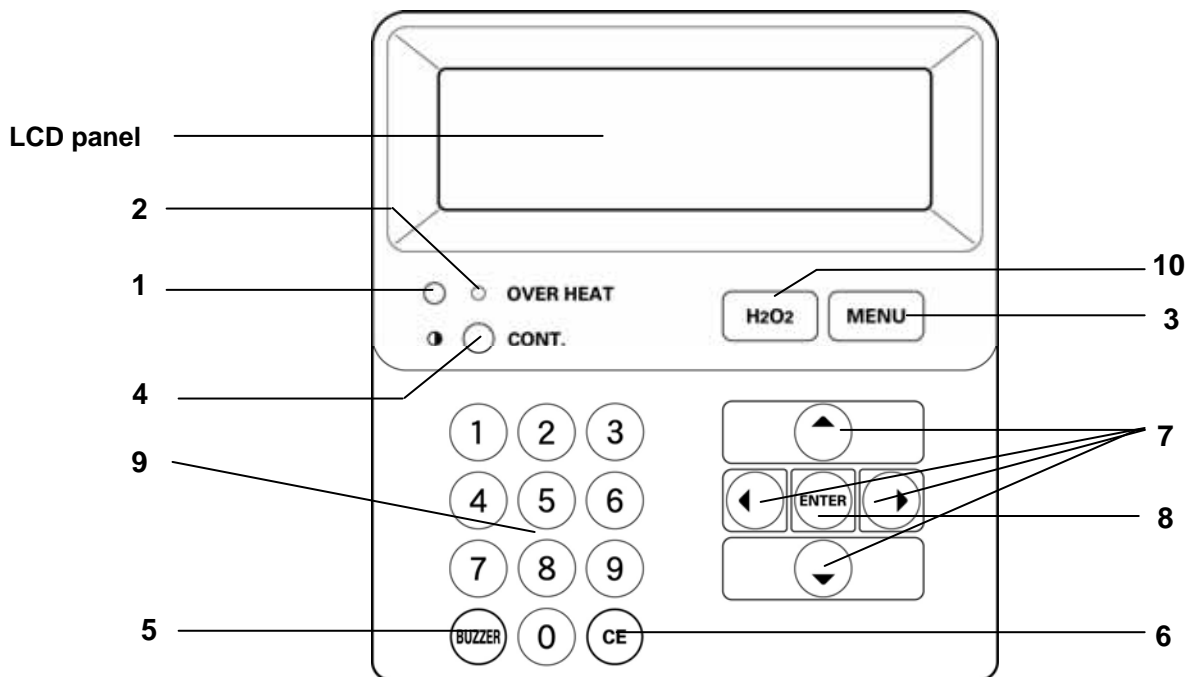

## 1. Upper limit regulator:

This regulator is used to set the upper temperature limit.

## 2. OVERHEAT indicator:

This indicator lights when the chamber temperature reaches the upper limit.

## 3. MENU Key:

Press this key to access the menu.

## 4. Contrast knob:

Turn this knob to adjust the contrast of the LCD.

## 5. BUZZER Key:

Press this key to silence the buzzer.

**Note:** It is not possible to silence the buzzer for an upper limit temperature alarm.

## 6. CE Key:

Press this key to clear the entered value when entering a setting.

## 7. Cursor Keys (Up, Down, Left, and Right):

Use these keys to move the cursor on the LCD panel.

## 8. ENTER Key:

Press this key to select a menu command. When entering a setting, pressing this key to move to the next parameter.

## 9. Numeric Keys

## 10. H<sub>2</sub>O<sub>2</sub> Key:

Press this key to start H<sub>2</sub>O<sub>2</sub> decontamination. Refer to page 49 for details.

The following optional components must be installed to perform decontamination.

- UV Lamp Add-on Kit (MCO-19UVS) (This is provided as standard equipment for the MCO-19M(UV).)
- H<sub>2</sub>O<sub>2</sub> Decontamination Kit (MCO-HL)
- H<sub>2</sub>O<sub>2</sub> Generator (MCO-HP)

# Remote alarm terminal

The remote alarm terminal is located at the rear right side of the incubator.

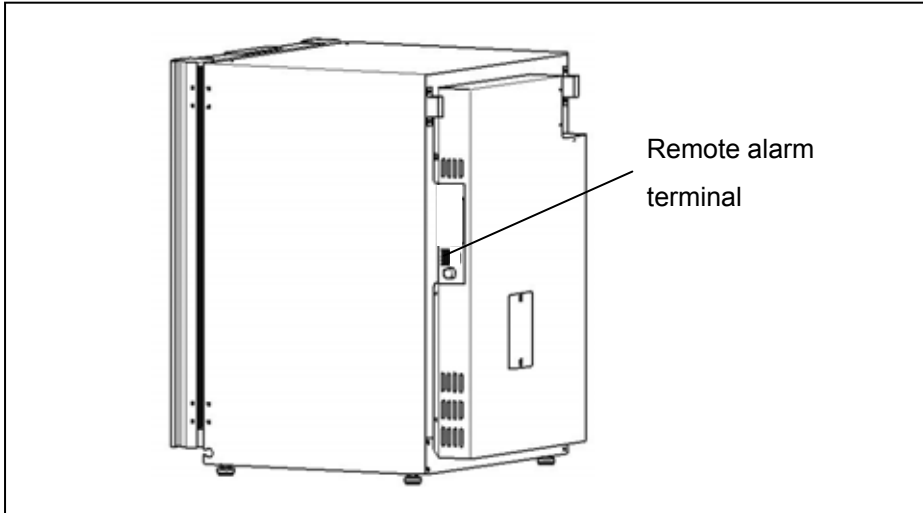

The alarm is outputted from this terminal. Contact capacity is DC 30 V, 2 A.

Contact output:

	between COM. and N.O.	between COM. and N.C.
At normal	Open	Close
At abnormal	Close	Open

**Note:**

The alarm is actuated when the power cord is disconnected from the outlet or the power switch is OFF.

- The remote alarm cannot be stopped by pressing the alarm buzzer stop key (BUZZER) since the remote alarm is not conjunct with the alarm buzzer stop key (BUZZER).

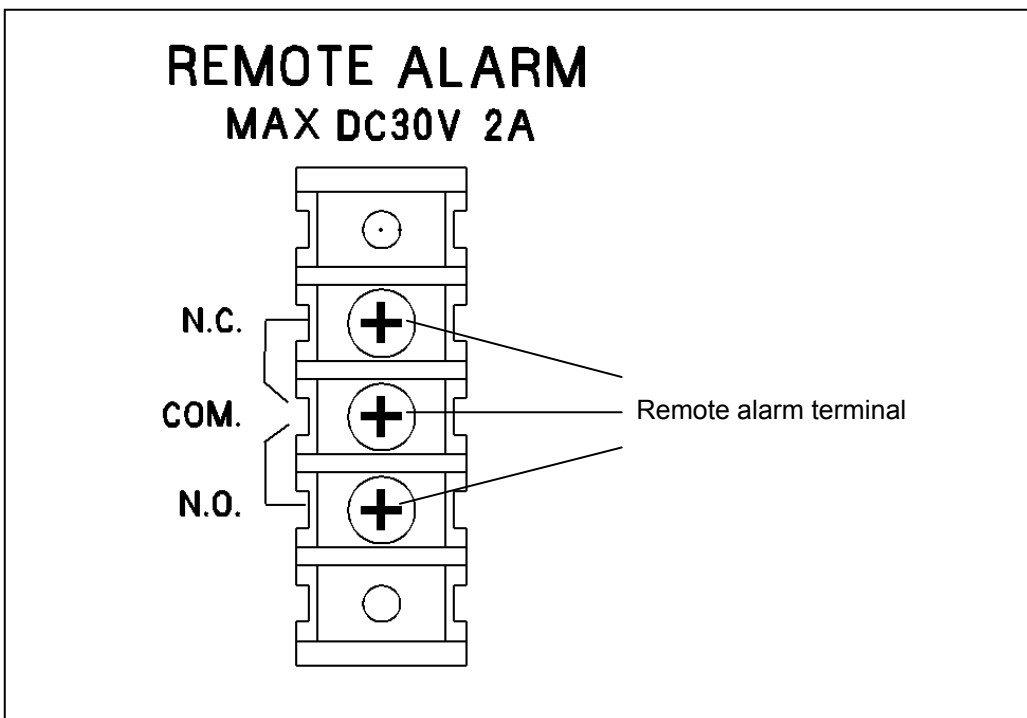

# INSTALLATION SITE

For correct operation of the Incubator, install it in a location with the following conditions.

## WARNING

When using CO<sub>2</sub> gas for control, **make sure that there is adequate ventilation**. Using CO<sub>2</sub> gas in a small room without adequate ventilation may cause gas poisoning or oxygen deprivation. In addition, when opening the Incubator doors, do not directly inhale the air in the chamber.

Si l'appareil est utilisé dans un endroit restreint, le niveau de la densité CO<sub>2</sub> de l'air peut s'élever et peut être nocif aux humains. Évitez d'aspirer l'air provenant de l'intérieur de l'appareil quand vous ouvrez la porte.

### ● Normal air environment

Install the Incubator in an environment with normal air.

### ● Do not expose to direct sunlight

Do not install the Incubator in a location where it will be exposed to direct sunlight. If the Incubator is operated in direct sunlight, performance will be adversely affected.

### ● Separate from heat sources

Do not install the Incubator near significant heat sources, such as heaters, boilers, ovens, or autoclaves. Heat will adversely affect the performance of the Incubator.

### ● Ambient temperature at least 5°C lower than set temperature

The control temperature of the Incubator is at least 5°C higher than the ambient temperature. For example, if the chamber is controlled at 37°C, the ambient temperature must normally be no more than 32°C. Do not allow the ambient temperature to become too high.

### ● Strong and level floor

Select a site with a strong and level floor. If the floor is uneven or the installation is not level, the Incubator will be unstable and this may cause accident or injury. To avoid vibration and noise, always make sure that the installation is stable. An unstable surface may result in vibration or noise.

## WARNING

**Install the Incubator at a location that can support the weight.** If the floor is not strong enough or if the installation is insufficient, the Incubator may fall over and cause injury.

**Always make sure that the floor is strong, even, and level, and that the Incubator will not tip over.**

An insufficient installation may result in injury due to water leakage or the Incubator falling over.

### ● Low humidity

Select a site with a relative humidity of 80% or lower. Using the Incubator in high humidity may result in current leakage or electric shock.

## WARNING

**Do not use the Incubator outdoors.** If the Incubator is exposed to rain water, it may result in current leakage or electric shock.

**Never install the Incubator in a moist location, such as near a sink or water line, or where it is likely to be exposed to water.** In addition, **do not install it near water or steam pipes.** Moisture can cause the insulation to deteriorate, which may result in current leakage or electric shock.

### ● No inflammable or corrosive gas

Never install the Incubator in a location where it will be exposed to inflammable or corrosive gas. Doing so may result in explosion or fire. In addition, insulation may deteriorate due to corrosion of protective casing, resulting in current leakage or electric shock.

### ● No falling objects

Do not install the Incubator in a location where there is the possibility of objects falling from above. Doing so may result in damage or accident.

# INSTALLATION

## 1. Remove the packing tape and clean up.

Remove all the tape that is securing the doors and inner attachments. Open the doors for ventilation. If the outer panels are dirty, dampen a cloth with a diluted neutral detergent and wipe them. (Using an undiluted solution may damage the plastic. Follow the diluting instructions for the detergent that is used.) Wipe off the residual detergent with a wet cloth and then wipe off any moisture.

## WARNING

**Do not leave plastic wrapping bags within reach of children.** If a bag is placed over a child's head, it can block the mouth and nose and cause suffocation.

## 2. Adjust the leveling feet.

Adjust the leveling feet by turning them counterclockwise to level the Incubator. (See the illustration on the right.)

## 3. Ground the Incubator.

Ground the Incubator during installation to prevent electric shock in case the insulation is not sufficient. If there is no ground wire at the location, consult with qualified service personnel.

### ● When a ground must be installed

If a grounded 3-pole outlet is not available, then a ground must be installed. Consult with qualified service personnel.

## WARNING

To prevent electric shock, **always ground the Incubator.** If grounding is not possible, then have a ground installed by qualified personnel. If the Incubator is not grounded, it may result in electric shock.

**Never connect the ground wire to a gas pipe, water pipe, lightning rod, or telephone ground wire.** Doing so may cause electric shock.

### ● Installing a ground fault circuit breaker

If using the Incubator in a location with moisture or humidity cannot be avoided, then it is recommended that a ground fault circuit breaker be installed in the power supply circuit (i.e., the power supply at the Incubator). Have the circuit breaker installed by qualified service personnel.

## CAUTION

**Do not climb on the Incubator or place objects on top of it.** Doing so may damage it or cause it to fall over, resulting in injury. If it is to be stacked, refer to page 72 and stack it securely.

### ● When the Incubator is not in use

Empty the water from the humidifying pan and remove moisture from the chamber. Make sure that the chamber is completely dry before closing the doors. Failure to do so may result in damage.

### ● Before moving the Incubator

Before moving the Incubator, empty the water from the humidifying pan, disconnect the power supply plug from the outlet, and make sure that the cord will not be damaged. Failure to do so may result in electric shock or fire.



## Connection of CO<sub>2</sub> gas cylinder

### **WARNING**

When connecting a gas cylinder to the Incubator, **confirm the gas type. Confirm that the connections are secure and that no gas will escape. Be sure to use the specified pressure.** Using an incorrect gas or pressure may result in explosion or fire, or in gas poisoning or oxygen deprivation due to escaping gas.

**Install the Incubator in a location with adequate ventilation.** If adequate ventilation cannot be provided, then install an alarm system using CO<sub>2</sub> and O<sub>2</sub> densitometers.

1. Use a liquefied CO<sub>2</sub> gas cylinder (at least 99.5% pure). The siphon (dip tube) type cannot be used.
2. Install the Gas Pressure Regulator (MCO-100L, purchased separately) specified by Sanyo on the CO<sub>2</sub> gas cylinder. Otherwise, use a CO<sub>2</sub> gas pressure regulator rated at 25 MPaG (250 kgf/cm<sup>2</sup>G, 3600 psiG) for the primary pressure, and 0.2 MPaG (2 kgf/cm<sup>2</sup>G, 30 psiG) for the secondary pressure.
3. Using the gas supply pipe that is provided, connect the CO<sub>2</sub> gas pressure regulator to the CO<sub>2</sub> gas pipe inlet (located at the lower left-hand side on the rear panel of the Incubator).

#### **Note:**

If CO<sub>2</sub> is supplied to multiple CO<sub>2</sub> Incubators from a single gas cylinder, a CO<sub>2</sub> solid will be formed in the gas pressure regulator. The gas pressure regulator safety valve will operate, and there may be an explosive sound.

#### **When the MCO-21GC is not mounted**

Using the gas supply pipe that is provided, connect the CO<sub>2</sub> gas pressure regulator for the CO<sub>2</sub> gas cylinder to CO<sub>2</sub> gas pipe connection port A on the Incubator. After connecting the pipe, check to make sure that no gas is leaking.

#### **When the MCO-21GC is mounted**

Connect a pair of CO<sub>2</sub> gas cylinders with CO<sub>2</sub> gas pressure regulators independently. The gas supply line will be switched automatically. Connect the main cylinder to port A and the reserve cylinder to port B. After connecting the cylinders, check to make sure that no gas is leaking.

- For details on installing the optional automatic CO<sub>2</sub> Cylinder Changeover System (MCO-21GC), refer to the MCO-21GC installation guide. For details on using the MCO-21GC, refer to page 67.

4. Set the CO<sub>2</sub> gas on the secondary side to 0.03 MPaG (0.3 kgf/cm<sup>2</sup>G, 4.3 psiG) for gas injection. As the pressure increases, the CO<sub>2</sub> gas concentration control range will increase. Excessive pressure may cause gas supply lines inside the Incubator to come loose, which may result in gas poisoning or oxygen deprivation due to the escaping of gas. If gas lines come loose, the Incubator must be repaired.

- The gas lines connected to the Incubator will degrade over time. If any deterioration or abnormalities are found during inspection, replace the lines immediately.

## Connection of N<sub>2</sub> (or O<sub>2</sub>) gas cylinder

### WARNING

Check the gas type and ensure that it is fit for the purpose. Make sure that all pipes are connected correctly and are not liable to become disconnected. Ensure that the gas pressure is set at the specified value. Improper connection of the gas pipe or use of incorrect gas pressure may result in leakage of gas. Elevated level of gas can be hazardous to health and may lead to asphyxiation and risk of death.

This incubator needs N<sub>2</sub> or O<sub>2</sub> gas depending on the setting of O<sub>2</sub> density. The selection is as follows:

When the setting of O<sub>2</sub> density is less than 18%: N<sub>2</sub> gas

When the setting of O<sub>2</sub> density is more than 22%: O<sub>2</sub> gas

O<sub>2</sub> density in the atmosphere is about 20%. For the control of O<sub>2</sub> density in the chamber, O<sub>2</sub> gas is diluted by N<sub>2</sub> gas when the setting of O<sub>2</sub> density is less than that of the atmosphere. On the contrary, O<sub>2</sub> gas is added when the setting of O<sub>2</sub> density is more than that of the atmosphere.

1. Install a gas pressure regulator (optional accessory MCO-100L) on N<sub>2</sub> or O<sub>2</sub> gas cylinder. Or use a regulator rated at 25 MPaG (250 kgf/cm<sup>2</sup>G, 3600 psiG) on the primary side and 0.2 MPaG (2.0 kgf/cm<sup>2</sup>G, 30 psiG) on the secondary side.

2. Using the gas tube provided, connect the pressure regulator to the connecting port A/B for N<sub>2</sub>/O<sub>2</sub> gas pipe located at the rear left side of the incubator. Connect the main cylinder to the connecting port A for N<sub>2</sub>/O<sub>2</sub> gas pipe and connect the sub-cylinder to the connecting port B for N<sub>2</sub>/O<sub>2</sub> gas pipe so that the gas supply can be switched automatically when one gas cylinder is empty. Connect the same gas type to both connecting port A/B for N<sub>2</sub>/O<sub>2</sub> gas pipe. Never connect N<sub>2</sub> gas and O<sub>2</sub> gas at the same time to the connecting port A/B for N<sub>2</sub>/O<sub>2</sub> gas pipe respectively.

3. Set the N<sub>2</sub> or O<sub>2</sub> gas pressure on the secondary side to 0.05 MPaG (0.5 kgf/cm<sup>2</sup>G, 7.1 psiG) (at gas injection). The higher gas pressure makes control range of O<sub>2</sub> density wider. In addition, excessive pressure may cause disconnection of internal pipes inside the incubator, which will result in leakage of N<sub>2</sub> or O<sub>2</sub> gas into the atmosphere. Elevated level of CO<sub>2</sub> gas or O<sub>2</sub> gas can be hazardous to health and may lead to asphyxiation and risk of death or fire by gas leakage. The repair of the incubator will be necessary if the internal pipe is disconnected.

4. Check that no gas is leaking at any point where the pipe connects with the gas regulator or the incubator.

● The gas lines connected to the Incubator will degrade over time. If any deterioration or abnormalities are found during inspection, replace the lines immediately.

### WARNING

O<sub>2</sub> gas increases the susceptibility of substances to burn. Take care of the handling of flame in a room where the incubator is installed.

## Connection of gas injection nozzle

In the case of control of O<sub>2</sub> density in the chamber, connect the gas injection nozzle to the gas injection port by using the connecting pipe enclosed (inner diameter; 5 mm, outer diameter; 9 mm, length; 400 mm). This helps faster recovery of humidity after opening of the inner door.

Fill the humidifying pan with sterile distilled water so that the injection nozzle can be under the water level.

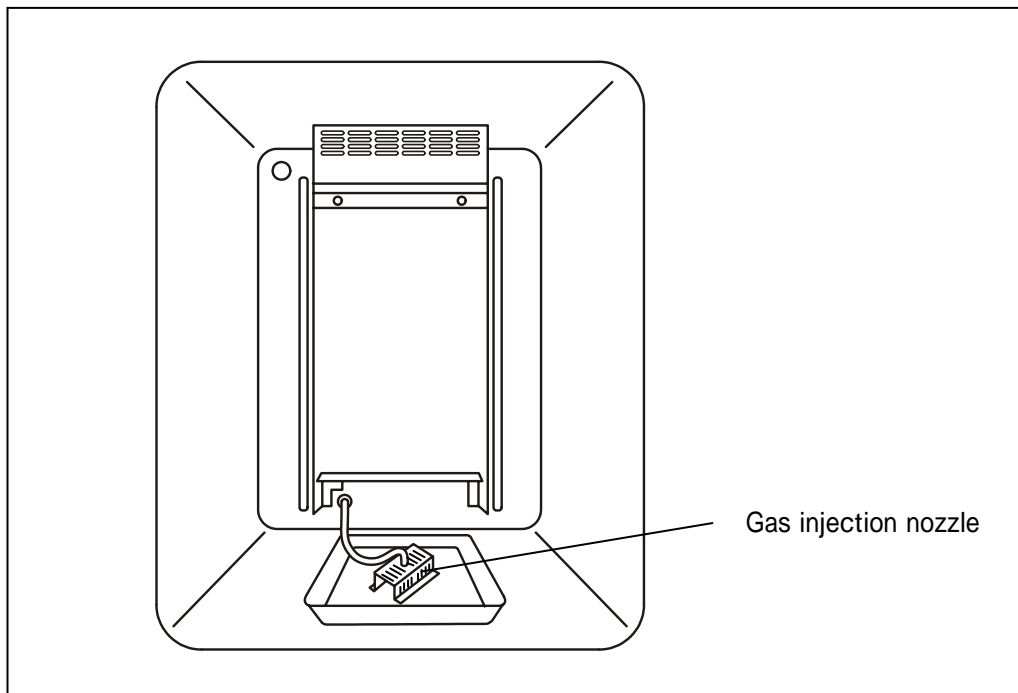

## Using the inner door and gastight split doors

● To effectively use gastight split doors, set three trays (standard equipment) at the same level as bottom side of each gastight split door.

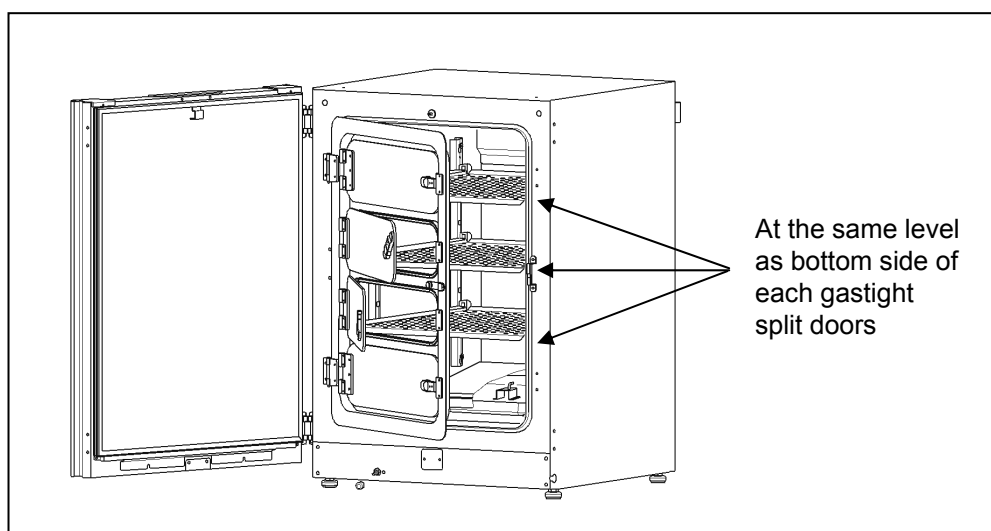

# PREVENTING CONTAMINATION

To prevent contamination of the chamber, select a suitable installation site.

- **Avoid locations with high temperatures or humidity.**

Avoid locations with high temperatures or humidity, because of a greater presence of microorganisms in the air.

- **Avoid locations with passers-by or drafts.**

Avoid locations near doors, air conditioners, fans, etc., where passers-by or drafts can facilitate the entry of microorganisms into the chamber.

- **If possible, use a cleanroom.**

To achieve a better culture, it is recommended that a cleanroom be used if one is available.

- **Use clean containers.**

The greatest cause of contamination is dirty containers for cultures. Be careful not to get containers or trays dirty when taking them in and out.

- **Keep the chamber clean.**

Wipe off any fingerprints. If water spills from the humidifying pan, or if the doors are left open for a long time, condensation may form on the inside of the doors. If that occurs, wipe off the condensation with a dry sterile gauze. In particular, clean and disinfect the chamber if the culture medium is spilled. For details, refer to *Routine Maintenance* on page 45.

- **Use sterile distilled water in the humidifying pan.**

Always use sterile distilled water in the humidifying pan. Do not use ultrapure water, because it may contain red rust-like suspended particles.

A water level alarm is displayed in the status display area on the control panel. Quickly refill the water in the pan when the water level alarm is displayed. Adding low-temperature water will significantly lower the temperature in the chamber. Clean the humidifying pan once a month.

- **Keep the Incubator out of direct airflows from air conditioners or fans.**

Cool airflow from an air conditioner may cause condensation and lead to possible contamination.

# PRECAUTIONS FOR CULTURES

- **Leave space between culture containers.**

Always leave space for ventilation between culture containers (Petri dishes, flasks, etc.). Inadequate spacing may result in uneven temperature distribution and CO<sub>2</sub> gas concentration.

- **Do not place harmful materials in the chamber.**

Never place samples that release acidic, alkali, or corrosive gas in the chamber. Doing so may cause damage resulting from discoloration or corrosion.

- **Close the inner door and all gastight split doors.**

Always close the inner door and all gastight split doors before closing the outer door. Failure to close the inner door or any gastight split door will adversely affect performance even if the outer door is closed.

- **Open and close the doors gently.**

Always open and close the doors gently. Closing the doors forcefully may cause spillage of the culture medium, incomplete closing, or damage to the gasket. Before opening the inner door, check through the glass to confirm that the UV lamp is OFF (if the MCO-19M(UVH)/19M(UV) or the optional MCO-19UVS is installed).

- **Be careful when closing the outer door.**

Use the handle when closing the outer door. Holding the door in other places may cause injury by getting fingers caught in the door. Do not lean on the outer door. Doing so may result in injury from the outer door coming loose or the Incubator falling over, or it may cause current leakage or electric shock.

- **Be careful of the inside of the outer door.**

The inside of the outer door may become hot.

- **Avoid using excessive force on the inner door.**

Do not put your hand on the glass, poke it with sharp objects, or apply strong force. Doing so may result in injury from breaking the glass.

- **Check the cause of any alarm buzzer.**

If an alarm buzzer sounds while the Incubator is in use, immediately check the cause of the alarm. For details on what may cause an alarm buzzer to sound, refer to page 55.

## Using the Unlock Key

### ● Unlocking when power is interrupted

If power is interrupted to the MCO-19M(UVH)/19M(UV) with an MCO-HL installed, the outer door is electrically locked. To unlock the outer door while the power is interrupted, use the unlock key that is provided. To lock the outer door again, turn the unlock key to the lock direction while the door is open. After the door has been locked condition manually, then close the door.

#### **Note:**

The outer door cannot be locked by using the unlock key while the door is closed. Lock the door while it is open. Attempting to turn the unlock key while the door is closed may damage the electric lock system.

### **WARNING**

For the MCO-19M(UVH)/19M(UV) with an MCO-HL installed, the outer door is electrically locked during decontamination. The chamber is filled with H<sub>2</sub>O<sub>2</sub> gas during decontamination. **Do not unlock the door during decontamination.**

## CORRECT OPERATION

Use the following procedure to start trial operation or actual operation of the Incubator.

1. Install the Incubator correctly, referring to *Installation* on page 15.
2. Remove the packing materials from the chamber and inner attachments. Clean and disinfect the chamber and inner attachments, referring to *Routine Maintenance* on page 45.
3. Add approximately 1.5 L of sterile distilled water to the humidifying pan. (Refer to page 48.)
4. Turn ON the power supply switch on the left side of the rear panel of the Incubator.

#### **Note:**

The humidity in the Incubator chamber is adjusted to the optimum setting. To prevent condensation on the surface inside chamber and the inner door, there is a low-temperature area under the humidifying pan in the bottom of chamber to recondense evaporated moisture. Condensation may occur around the humidifying pan at the bottom of the chamber, but this does not indicate a problem.

# LCD PANEL

The following display (called the Top Display) will appear when the power switch is turned ON. The default temperature is 37.0°C, the default CO<sub>2</sub> density is 0% and the default O<sub>2</sub> density is 20%. The date and time are preset at the factory. Refer to page 38 to change the date and time.

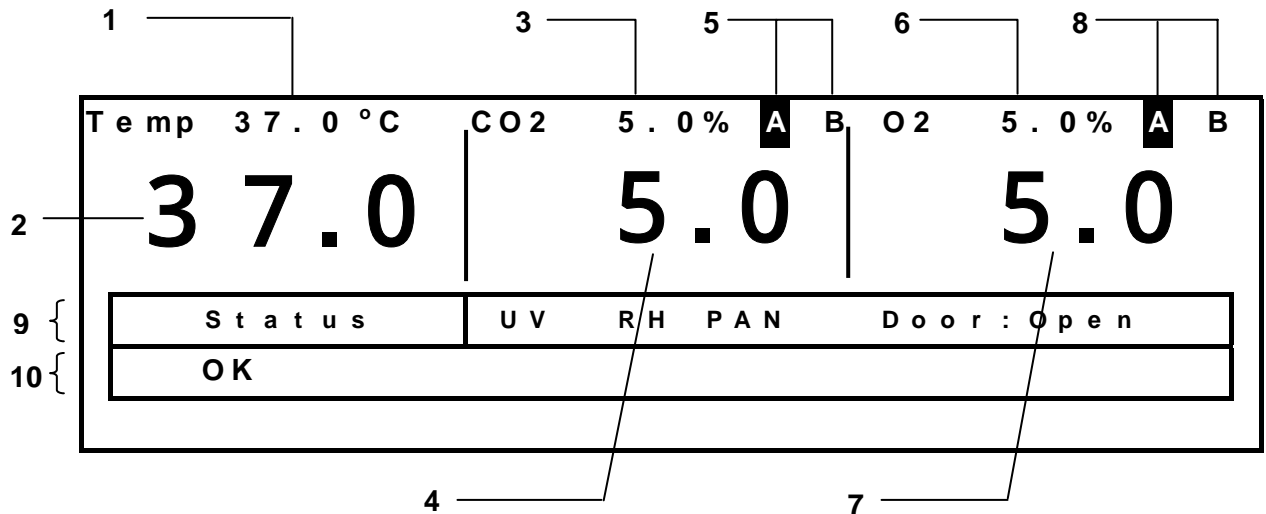

## 1. Display of set value of temperature

The set value of chamber temperature is displayed.

## 2. Display of current temperature

The current chamber temperature is displayed.

## 3. Display of set value of CO<sub>2</sub> density

The set value of the chamber CO<sub>2</sub> density is displayed.

## 4. Display of current CO<sub>2</sub> density

The current chamber CO<sub>2</sub> density is displayed.

## 5. Display of current CO<sub>2</sub> cylinder

A and B will be displayed if the optional Automatic CO<sub>2</sub> Cylinder Changeover System (MCO-21GC) is installed. The port of the CO<sub>2</sub> gas pipe that is currently supplying CO<sub>2</sub> will be displayed in reverse video. Nothing will be displayed if the MCO-21GC is not installed.

## 6. Display of set value of O<sub>2</sub> density

The set value of the chamber O<sub>2</sub> density is displayed.

## 7. Display of current O<sub>2</sub> density

The current chamber O<sub>2</sub> density is displayed.

## 8. Display of current N<sub>2</sub>/O<sub>2</sub> cylinder

The connecting port A/B for N<sub>2</sub>/O<sub>2</sub> gas pipe that is currently supplying N<sub>2</sub> or CO<sub>2</sub> will be displayed in reverse video.

---

## **9. Status display field**

Various status or alarms are displayed.

- When UV lamp is lit: "UV" is displayed in reverse video. (If the MCO-19M(UVH)/19M(UV) or the optional MCO-19UVS is installed).
- When humidifying water is low: "RH PAN" is displayed in reverse video and blinks.
- When the door is open: "Door: Open" is displayed in reverse video.

## **10. Message display field**

A message is displayed when fault occurs. The message is displayed alternately in normal characters and reverse video. Refer to pages from 55 to 57 for alarm details. "OK" is displayed during normal operation.



# BASIC OPERATIONS ON CONTROL PANEL

The following operation are possible through control panel:

- **Setting the temperature** ··· The chamber temperature can be set (page 25).
- **Setting the CO<sub>2</sub> density** ··· The chamber CO<sub>2</sub> density can be set (page 25).
- **Setting the O<sub>2</sub> density** ··· The chamber O<sub>2</sub> density can be set (page 25).
- **Setting the key lock** ··· Changing the temperature and CO<sub>2</sub> density can be disabled (page 26).
- **Setting alarms** ··· The temperature alarm, CO<sub>2</sub> density alarm, O<sub>2</sub> density alarm (page 33) and upper limit alarm temperature (page 32) can be set.
- **Setting UV parameters** ··· ON/OFF parameters and the ON period of the UV lamp can be set for the MCO-19M(UVH)/19M(UV) or when the Incubator is equipped with the optional MCO-19UVS (page 36).
- **Setting other parameters** ··· The initial settings of the date, time, and log cycle (page 38), and the LCD display and baud rate (page 40) can be set.
- **Displaying the operation log and transferring data** ··· A graph of past operation data can be displayed (page 41) and operation data can be transferred to a PC (page 43).
- **H<sub>2</sub>O<sub>2</sub> decontamination** ··· H<sub>2</sub>O<sub>2</sub> decontamination of the chamber and internal attachments can be performed when the optional H<sub>2</sub>O<sub>2</sub> Generator (MCO-HP) is installed (page 49).
- **Automatic N<sub>2</sub> (or O<sub>2</sub>) gas cylinder changeover** ··· The N<sub>2</sub> (or O<sub>2</sub>) gas cylinder can be switched (page 30). The CO<sub>2</sub> gas cylinder can be switched when the optional automatic CO<sub>2</sub> Cylinder Changeover System (MCO-21GC) is installed (page 67).
- **Setting the standard gas density** ··· The standard gas density can be set when the optional Automatic Standard Gas Calibration Kit (MCO-SG) is installed. (page 69)

# BASIC PARAMETERS

## Setting the chamber temperature, CO<sub>2</sub> and O<sub>2</sub> density

The setting procedure for the chamber temperature, CO<sub>2</sub> and O<sub>2</sub> density are given below. (Default settings: Chamber temperature: 37°C, CO<sub>2</sub> density: 0%, O<sub>2</sub> density: 20%)

The Incubator automatically starts operation using these settings after the power is turned ON.

1. From the Top Display, press the MENU Key to access the menu. Select **Set** and press the ENTER Key.

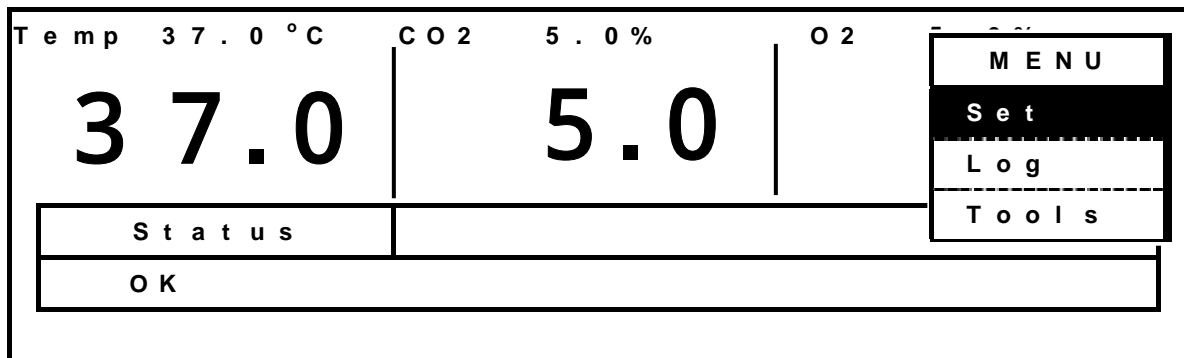

2. The Stand-By Setting Display will be displayed. Set the parameters.

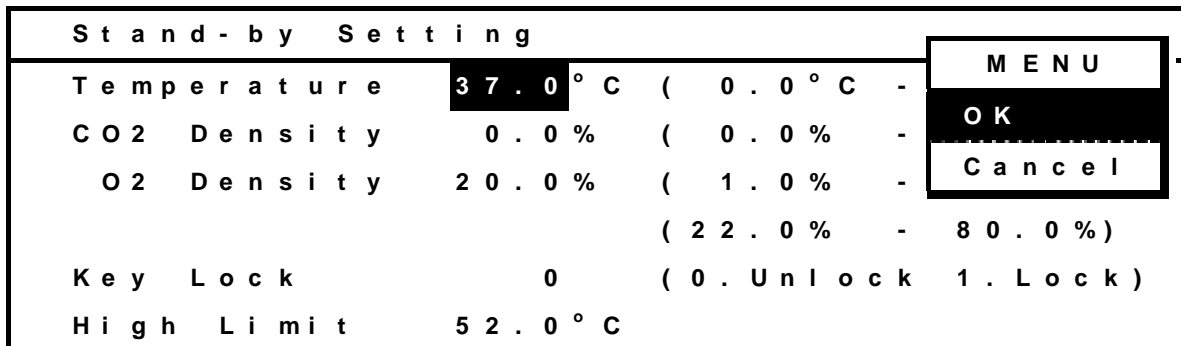

The setting ranges of the parameters are as follows:

- Temperature: 0 to 50°C. To set 37.0°C, enter 370.
- CO<sub>2</sub> density: 0 to 20%. To set 5.0%, enter 050.
- O<sub>2</sub> density: 1 to 18 and 22 to 80%. To set 5.0%, enter 050.

3. Press the MENU Key to display the menu after setting the parameters. Select **OK** and press the ENTER Key. The settings will be saved.

### Note:

When starting the Incubator for the first time or after not using it for an extended period of time, allow at least 4 hours for the chamber temperature, humidity, CO<sub>2</sub> sensor and O<sub>2</sub> sensor to become stable after setting the desired chamber temperature at a 0% CO<sub>2</sub> density and a 20% O<sub>2</sub> density. Then change the setting to the desired CO<sub>2</sub> and O<sub>2</sub> density.

## Setting the key lock

1. To set the key lock, change the value of the key lock parameter from 0 to 1 on the Stand-by Setting Display and press the ENTER Key. The buzzer will sound briefly and the keys will be locked.

S t a n d - b y   S e t t i n g						
T e m p e r a t u r e	3 7 . 0 ° C	( 0 . 0 ° C -	<table border="1"> <tr> <td>M E N U</td> </tr> <tr> <td><b>OK</b></td> </tr> <tr> <td>C a n c e l</td> </tr> </table>	M E N U	<b>OK</b>	C a n c e l
M E N U						
<b>OK</b>						
C a n c e l						
C O 2   D e n s i t y	5 . 0 %	( 0 . 0 % -				
O 2   D e n s i t y	5 . 0 %	( 1 . 0 % -				
		( 2 2 . 0 % - 8 0 . 0 % )				
K e y   L o c k	<b>1</b>	( 0 . U n l o c k	1 . L o c k )			
H i g h   L i m i t	5 2 . 0 ° C					

2. "Key Lock" will be displayed in reverse video at the right side of "Stand-by Setting", and changing the temperature and CO<sub>2</sub> density settings will be disabled.

3. Press the MENU Key to display the menu, select **OK** and press the ENTER Key. The settings will be saved.

## Releasing the key lock

1. To remove the key lock, change the value of the key lock parameter from 1 to 0 on the Stand-by Setting Display and press the ENTER Key.

Stand-by Setting		Key Lock	
Temperature	37.0 °C	( 0.0 °C - 50.0 °C )	
CO2 Density	5.0 %	( 0.0 % - 20.0 % )	
O2 Density	5.0 %	( 1.0 % - 18.0 % )	
		( 22.0 % - 80.0 % )	
Key Lock	0	( 0. Unlock 1. Lock )	
High Limit	52.0 °C		

2. The cursor will move to the Password Field. Input the 4-digit password (default: 0000) and press the ENTER Key. When key lock is released, the buzzer will sound briefly, and "Key Lock" will disappear from the Stand-by Setting Display.

Stand-by Setting		Key Lock	
Temperature	37.0 °C	( 0.0 °C - 50.0 °C )	
CO2 Density	5.0 %	( 0.0 % - 20.0 % )	
O2 Density	5.0 %	( 1.0 % - 18.0 % )	
		( 22.0 % - 80.0 % )	
Key Lock	0	Password	██████
High Limit	52.0 °C		

3. Press the MENU Key to display the menu, select **OK** and press the ENTER Key. The settings will be saved.

**Note:** The buzzer will sound for a long time if the wrong password is entered. Enter the correct password. The password for releasing the key lock must be shared and administered among all users of the Incubator. The password is set to 0000 when the Incubator is shipped from the factory. The procedure for changing the password is given next.

## Setting the key lock password

1. From the Top Display, press the MENU Key to display the menu, select **Tools**, and press the ENTER Key.

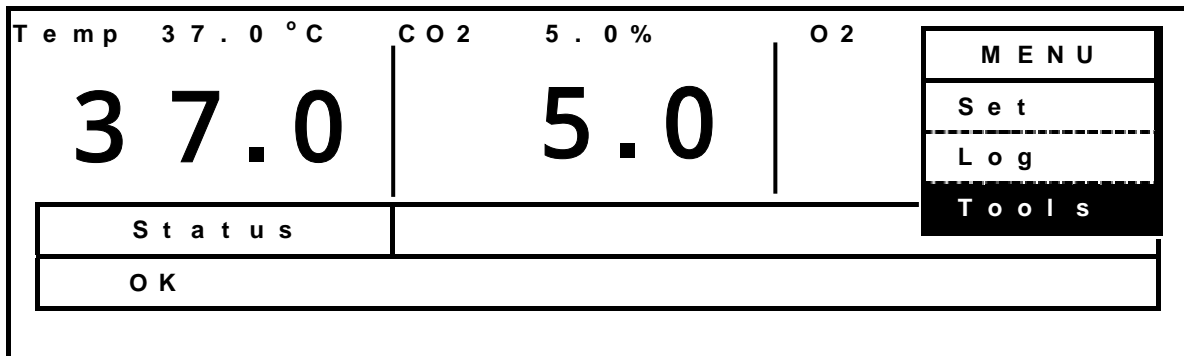

2. Select **Key Lock PW Setting** from the Select Tools Display, press the MENU Key to display the menu, select **OK**, and press the ENTER Key.

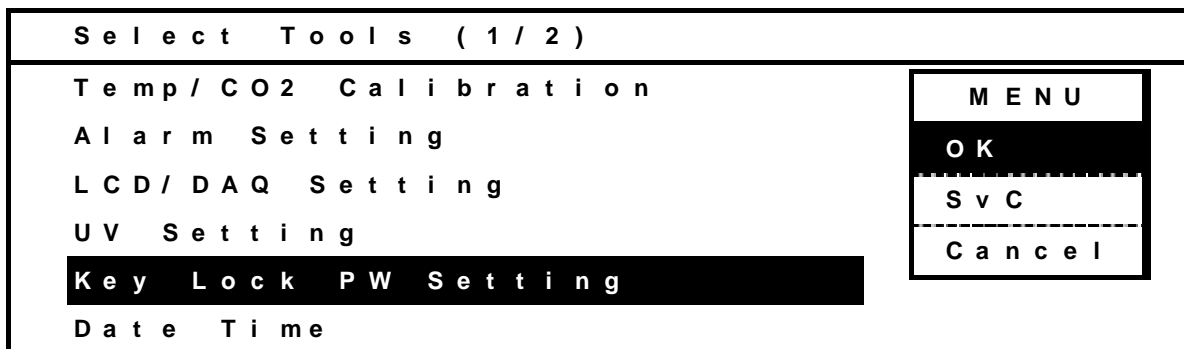

3. Input the current user password (4 digits), select **OK**, and press the ENTER Key. (The default user password is 0000 when the Incubator is shipped from the factory.)

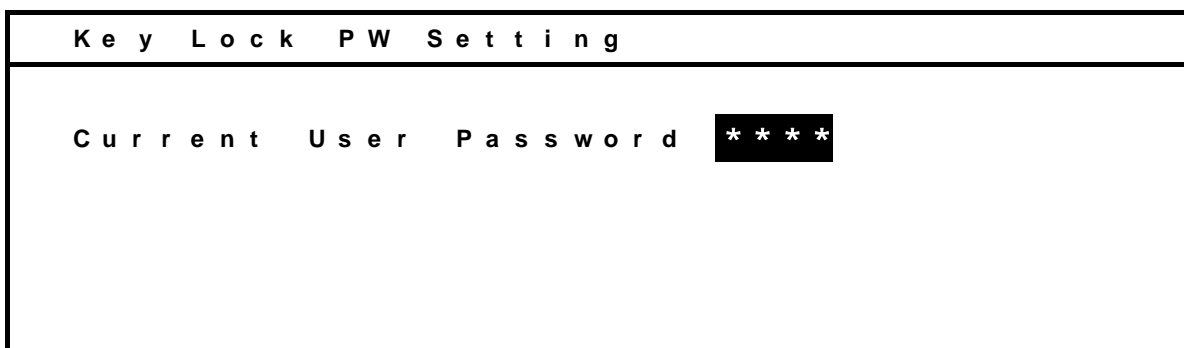

4. Enter the new user password (4 digits), select **OK**, and press the ENTER Key.

Key Lock PW Setting	
New User Password	****

5. Enter the new user password again, select **OK**, and press the ENTER Key to save. After that press the MENU Key to display the menu, and select **Cancel** from the menu.

Key Lock PW Setting	
New User Password	****
Re Enter User Password	****

**Note:**

Be careful not to forget the key lock password. If you have forgotten the password and cannot release the key lock, contact a Sanyo sales representative or agent.

## Automatic N<sub>2</sub> (or O<sub>2</sub>) gas cylinder changeover

This incubator switches the gas supply lines when one N<sub>2</sub> (or O<sub>2</sub>) gas cylinder becomes empty.

**Note:** An automatic switcher for the CO<sub>2</sub> gas supply lines (MCO-21GC) is available as an optional accessory.

Perform the following procedure

1. Connect 2 gas tubes to connecting ports A/B for N<sub>2</sub>/O<sub>2</sub> gas pipe. Connecting ports A/B for N<sub>2</sub>/O<sub>2</sub> gas pipes are located on the left back of the Incubator. (Refer to page 9).
2. Connect a N<sub>2</sub> (or O<sub>2</sub>) gas cylinder equipped with a gas pressure regulator to each gas tube. Refer to page 17 for information on connecting the gas cylinders. ("Gas cylinder A" is the N<sub>2</sub> (or O<sub>2</sub>) gas cylinder connected to the connecting port A for N<sub>2</sub>/O<sub>2</sub> gas pipe, and "gas cylinder B" is the N<sub>2</sub> (or O<sub>2</sub>) gas cylinder connected to the connecting port B for N<sub>2</sub>/O<sub>2</sub> gas pipe.)
3. Open the valves of both gas cylinders.
4. The current N<sub>2</sub> (or O<sub>2</sub>) gas supply line is displayed on the Top Display.

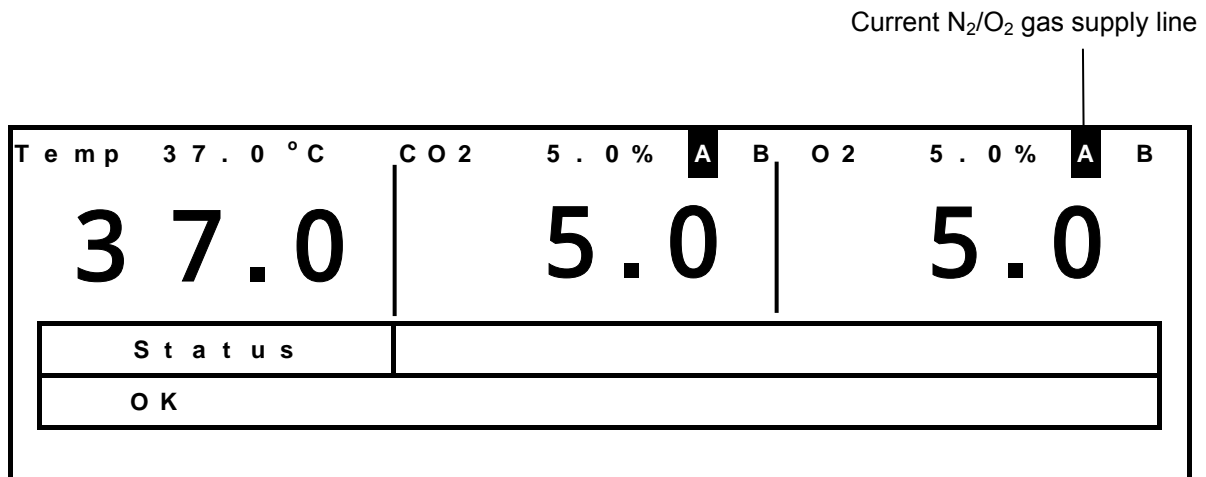

5. The incubator detects that there is no more N<sub>2</sub> (or O<sub>2</sub>) gas in a cylinder when the O<sub>2</sub> density in the chamber does not increase for a while even after opening the N<sub>2</sub>/O<sub>2</sub> gas valve in the Incubator. It switches the gas supply line when it detects that there is no more gas. At that time, the following indications of switching the gas cylinder are provided.

	Message display field	Display of gas supply
When N <sub>2</sub> (or O <sub>2</sub> ) gas gas supply line switches automatically.	Err02: N <sub>2</sub> /O <sub>2</sub> gas Empty is displayed.	The character for gas supply line that is empty blinks. The gas supply line that is currently being used is displayed in reverse video.

To silence the buzzer, press the BUZZER Key. The alarm condition is cleared and normal operation continues.

6. When gas cylinder A is switched to B, remove gas cylinder A and replace it with new one.

**Note:** Be careful when handling the empty N<sub>2</sub> (or O<sub>2</sub>) gas cylinder. Some gas may still be left in the cylinder.

•When gas cylinder B becomes empty, the line is switched to gas cylinder A again.

The incubator detects that there is no more N<sub>2</sub> (or O<sub>2</sub>) gas in a cylinder when the O<sub>2</sub> density in the chamber does not increase for a while even after opening the N<sub>2</sub> (or O<sub>2</sub>) gas valve in the Incubator. The supply line may also be switched for other reasons even though there is gas left in the cylinder: blocking or restricting of gas tube, reduction of N<sub>2</sub> (or O<sub>2</sub>) gas pressure, or improper opening of N<sub>2</sub> (or O<sub>2</sub>) gas cylinder. Always check the gas quantity in the cylinder before disconnecting it.

• Use the following procedure to manual switch the line between N<sub>2</sub> (or O<sub>2</sub>) gas cylinders A and B. This procedure shows switching the line from N<sub>2</sub> (or O<sub>2</sub>) gas cylinder B to A as an example.

1. From the Top Display, press the Up Cursor Key for 3 seconds.

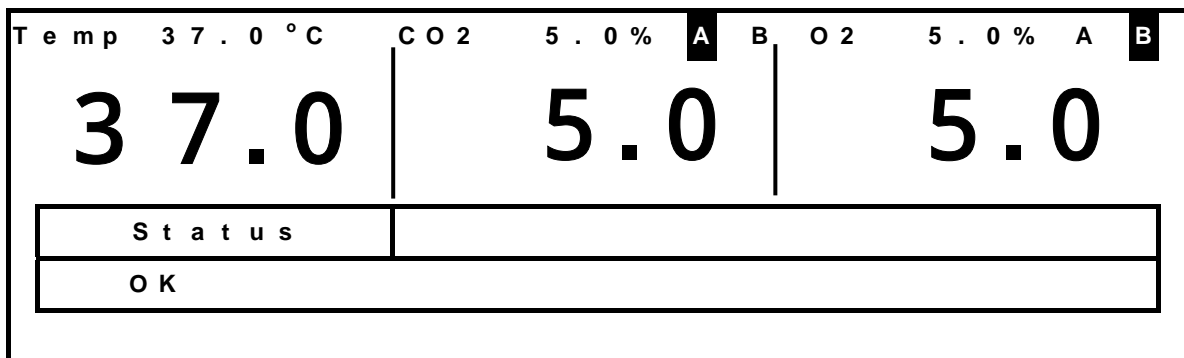

2. The N<sub>2</sub> (or O<sub>2</sub>) gas supply line will be switched from cylinder B to A

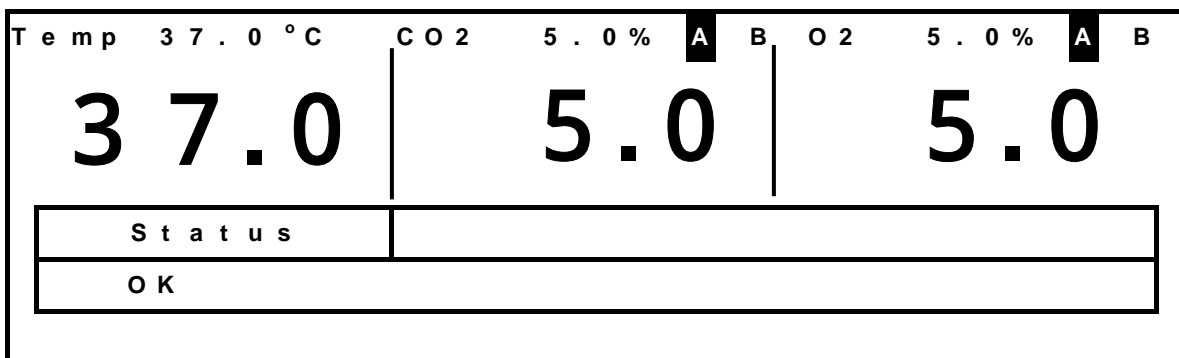

(When the line needs to be switched from N<sub>2</sub> (or O<sub>2</sub>) gas cylinder A to B, press the Down Cursor Key for 3 seconds.)



## Setting the upper limit alarm temperature

An upper limit temperature alarm is provided with the Incubator. The alarm temperature can be changed by using the following procedure.

1. In the Stand-by Setting Display, turn the upper limit regulator on the control panel using a small screwdriver to set the desired upper limit alarm temperature. The upper limit temperature can be set between 35 and 51°C.

S t a n d - b y   S e t t i n g			
T e m p e r a t u r e	3 7 . 0 ° C	(	0 . 0 ° C - 5 0 . 0 ° C )
C O 2   D e n s i t y	5 . 0 %	(	0 . 0 % - 2 0 . 0 % )
O 2   D e n s i t y	5 . 0 %	(	1 . 0 % - 1 8 . 0 % )
		(	2 2 . 0 % - 8 0 . 0 % )
K e y   L o c k	0	(	0 . U n l o c k   1 . L o c k )
H i g h   L i m i t	5 2 . 0 ° C		

**Note:**

- Set the upper limit alarm temperature (High Limit) to at least 5°C higher than the chamber set temperature.
- Set the upper limit alarm temperature to at least 50°C when H<sub>2</sub>O<sub>2</sub> decontamination is performed.

2. After setting the parameter, press the MENU Key to display the menu, select **OK**, and press the ENTER Key. The alarm temperature will be saved.

Refer to the tables of alarms and safety functions for culture operations on page 55 for details.

**Note:**

- The alarm temperature will be changed at any time by turning the upper limit regulator even if the Stand-by Setting Display is not displayed.
- Set the upper limit alarm temperature after the chamber reaches the set temperature for operation.

# ALARM PARAMETERS

1. Press the MENU Key from the Top Display to display the menu, select **Tools**, and press the ENTER Key.

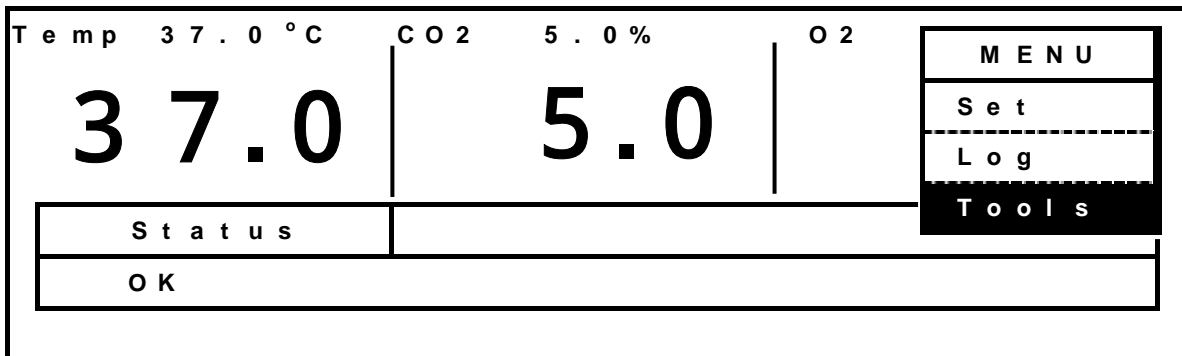

2. Select **Alarm Setting** from the Select Tools Display, press the MENU Key to display the menu, select **OK**, and press the ENTER Key.

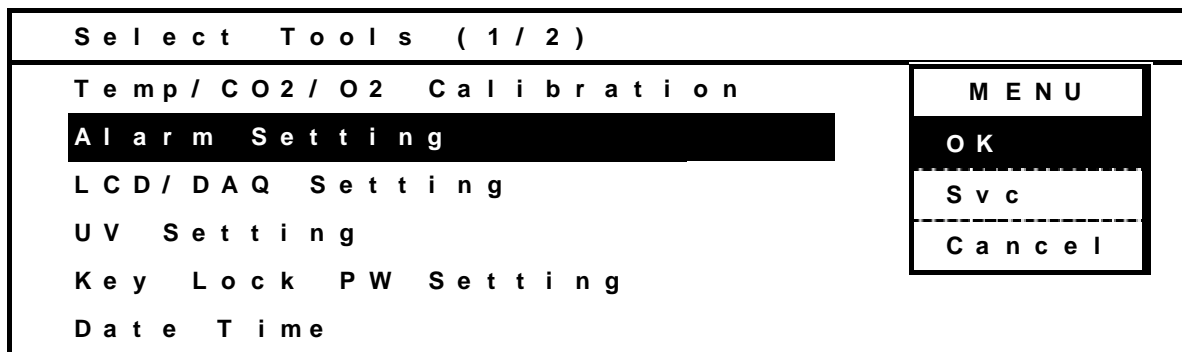

3. The Alarm Setting Display will appear. The temperature alarm, CO<sub>2</sub> alarm, O<sub>2</sub> alarm, alarm delay, ring back time, and door delay can be set on this display. The alarm buzzer can be silenced by pressing the BUZZER Key. The buzzer will sound again after the specified ring back time if the condition that caused the alarm continues. The ring back time can be set.

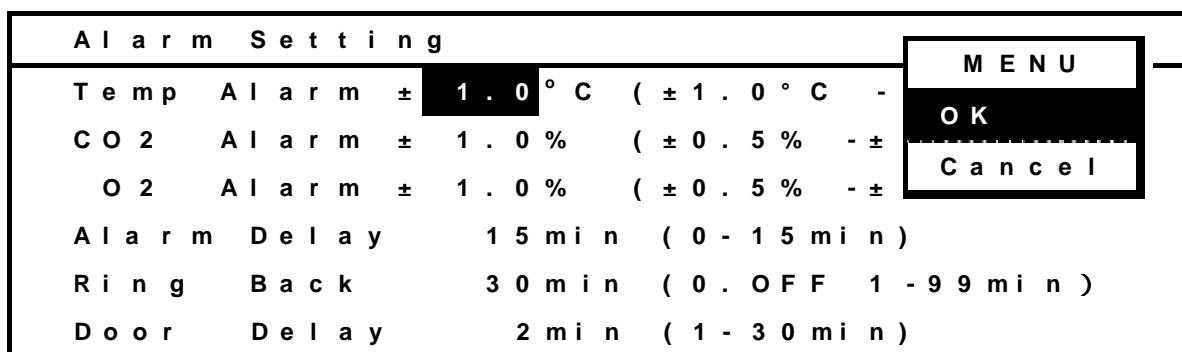

- Temperature alarm:  $\pm 1.0$  to  $\pm 5.0^{\circ}\text{C}$  (Default:  $\pm 1.0^{\circ}\text{C}$ )
- CO<sub>2</sub> alarm, O<sub>2</sub> alarm:  $\pm 0.5$  to  $\pm 5.0\%$  (Default:  $\pm 1.0\%$ )
- Alarm delay: 0 to 15 minutes (Default: 15 minutes)
- Ring back time: 1 to 99 minutes, or OFF (Default: 30 minutes)
- Door alarm delay: 1 to 30 minutes (Default: 2 minutes)

# UV LAMP PARAMETERS

A UV lamp is used with the MCO-19M(UVH)/MCO-19M(UV) or the MCO-19M with an MCO-19UVS UV Lamp Expansion Kit installed. Use the following procedures to make the settings.

## Using the UV lamp

A UV lamp is located inside the duct to sterilize the water in the humidifying pan and the air circulating in the chamber. Observe the following points to use the UV lamp correctly.

- When all chamber attachments are installed correctly, only the inside of the duct and the inside of the humidifying pan cover are exposed to UV light.
- Correctly install all of the chamber attachments when starting a cell culture, and never turn ON the UV lamp when the humidifying pan cover is removed.
- Always install the humidifying pan cover even when using the Incubator without turning ON the UV lamp. Leaving the cover uninstalled will affect the chamber temperature distribution and the humidity recovery performance.
- The UV lamp stays lit for a preset period of time after the outer door is closed. The default setting is for five minutes.
- If the outer door is not opened for at least 12 consecutive hours, the UV lamp will light for the preset time period every 12 hours.
- The recommended replacement time for the UV lamp (i.e., when the UV output ratio drops to 60% to 70% of its initial value) is when the accumulated ON time reaches 1,000 hours. When the accumulated ON time reaches approximately 1,000 hours, the "UV" will flash in the status display field on the LCD panel (when the UV lamp is not lit). It is recommended that the UV lamp be quickly replaced at this point. Consult a Sanyo sales representative or agent for information on replacing the UV lamp.
- If the UV lamp burns out, Err18:UV Lamp Abnormal will be displayed in the message display field. If this occurs, replace the UV lamp. When replacing the UV lamp, replace the glow starter (type FG-7P) at the same time. Consult a Sanyo sales representative or agent for information on replacing the UV lamp.
- If the UV lamp burns out (Err18:UV Lamp Abnormal will be displayed in the message display field), it will not be possible to perform H<sub>2</sub>O<sub>2</sub> decontamination. Replace the UV lamp and the glow starter.

## Precautions when using the UV lamp



### **WARNING**

**Do not look directly at UV light.** UV light is harmful to the eyes.

- **Always use the humidifying pan and humidifying pan cover.**

The humidifying pan and cover prevent UV light from escaping. Always use them even when not humidifying. To check whether the UV lamp is lit, open the outer door and then press the door switch with the inner door still closed. Visible blue light can be confirmed from the front of the humidifying pan cover. UV light is harmful to the eyes, so do not light the UV lamp when the inner door or humidifying pan cover is open.

- **Be careful when handling the UV lamp.**

There is a UV lamp inside of the chamber duct. Be careful not to damage it when installing or removing chamber attachments, the humidifying pan, or the H<sub>2</sub>O<sub>2</sub> Generator.

## Setting the UV lamp ON period

Use the following procedure to change the setting of the UV lamp ON period.

1. Press the MENU Key from the Top Display to display the menu, select **Tools**, and press the ENTER Key.

Temp 37.0 °C	CO2 5.0 %	O2	MENU
<b>37.0</b>	<b>5.0</b>		Set
Status			Log
OK			<b>Tools</b>

2. Select **UV Setting** from the Select Tools Display, press the MENU Key to display the menu, select **OK**, and press the ENTER Key.

Select Tools (1/2)	MENU
Temp / CO2 / O2 Calibration	<b>OK</b>
Alarm Setting	Svc
LCD / DAQ Setting	Cancel
<b>UV Setting</b>	
Key Lock PW Setting	
Date Time	

3. The UV Setting Display will appear. Set the UV Timer for the UV lamp ON period.

UV Setting
UV Timer <b>5</b> min (0 - 30 min)
UV Life 0 % (100 % = 1000 h)
UV Timer Ext +0 %
UV 24h Mode 0 (0 . OFF 1 . ON)

4. Press the MENU Key to display the menu, select **OK**, and press the ENTER Key. The parameter will be saved.

- The UV timer can be set from 0 to 30 min. The default setting is for 5 min. When the UV timer is set to zero, the UV lamp will not light.
- If the outer door is opened while the UV lamp is lit, the lamp will turn OFF. Then, when the door is closed, the lamp will light for the preset period of time.
- If the UV lamp ON time is set for longer than 10 minutes or if only the outer door is repeated opened and closed, condensation may occur in the chamber and may affect temperature distribution. It will also shorten the service life of the UV lamp.
- When replacing the UV lamp, consult with a Sanyo representative or agent.

**Note:** To compensate for the drop in UV ray output along with increased accumulated ON time of UV lamp, the Incubator automatically extends the UV lamp ON time according to the accumulated ON time. The automatically extended time is displayed as a percentage under *UV Timer Ext.* in the UV Setting Screen.

## Lighting the UV lamp for 24 hours

If the chamber has been contaminated by dirt or by spilling the medium, use the following procedure to decontaminate the chamber by lighting the UV lamp for 24 hours.

1. Remove all attachments from the chamber, including the trays, tray supports, side supports, fan cover, duct, fan, humidifying pan, humidifying pan cover, N<sub>2</sub> or O<sub>2</sub> gas injection nozzle, and. Clean all the attachments in an autoclave or with disinfectant alcohol.
2. Clean and wipe off inside the chamber with disinfectant alcohol.
3. Set the CO<sub>2</sub> density to 0% and O<sub>2</sub> density to 20%. Set the UV 24h Mode to 1 on the UV Setting Display.

U V   S e t t i n g			
U V   T i m e r	5	m i n	( 0 - 3 0 m i n )
U V   L i f e	0	%	( 1 0 0 % = 1 0 0 0 h )
U V   T i m e r   E x t	+ 0	%	
U V   2 4 h   M o d e	<b>1</b>		( 0 . O F F   1 . O N )

4. Press the MENU Key to display the menu, select **OK**, and press the ENTER Key. The parameter will be saved.

- This procedure must be preformed only with the outer door closed and the UV lamp turned OFF.
- The UV lamp will light continuously for 24 hours after this parameter is set. The setting is canceled if the outer door is opened. Perform the above procedure to set the 24-hours lighting mode again if you open the door.
- Install the attachments after completion of the 24-hour lighting mode.

**Note:** Set the upper limit alarm temperature to at least 10°C higher than the chamber set temperature when using the 24-hour lighting mode of UV lamp. The 24-hour lighting mode may cause an automatic chamber temperature alarm because the temperature of the chamber will increase.

# OTHER PARAMETERS

## Setting the date, time, and log interval

1. Press the MENU Key from the Top Display to display the menu, select **Tools** and press the ENTER Key.

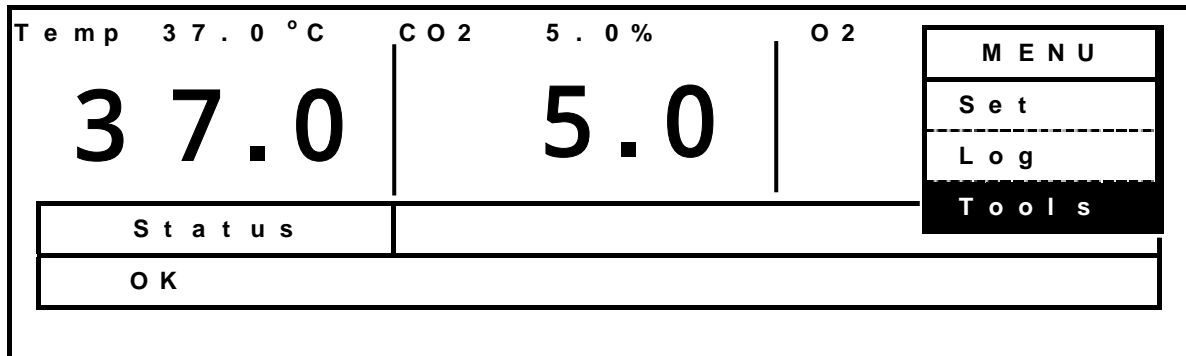

2. Select **Date Time** from the Select Tools Display, press the MENU Key to display the menu, select **OK**, and press the ENTER Key.

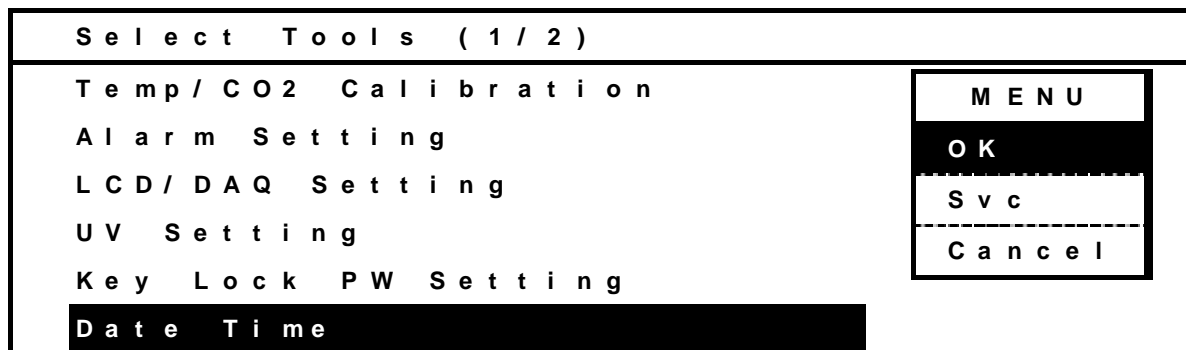

3. The Date Time Display will appear. Set the date, time and log interval.

Date Time	
Date	10 / 10 / 01 ( Y Y / M M / D D )
Time	10 : 05 : 00 ( h h : m m : s s )
Log Interval	6 min ( 2 - 30 min )

· Entering the date

Example for October 1, 2010: Enter 101001 in the Date Field.

· Entering the time

Example for 10:05:00: Enter 100500 in the Time Field.

· Entering the log interval

Example for 6 minutes: Enter 6 in Log Interval Field.

**Note:**

- The default is 6 minutes.
- The log interval can be set to between 2 and 30 minutes.
- Relation between the log interval and the period that can be saved
  - 1: Log interval of 2 minutes -- About 5 days
  - 2: Log interval of 6 minutes -- About 14 days
  - 3: Log interval of 30 minutes -- About 70 days

For the data beyond the above period, the older data is deleted to save the newer data.



## Initial settings (LCD/DAQ parameters)

1. Select **LCD/DAQ Setting** from the Select Tools Display, press the MENU Key to display the menu, select **OK**, and press the ENTER Key.

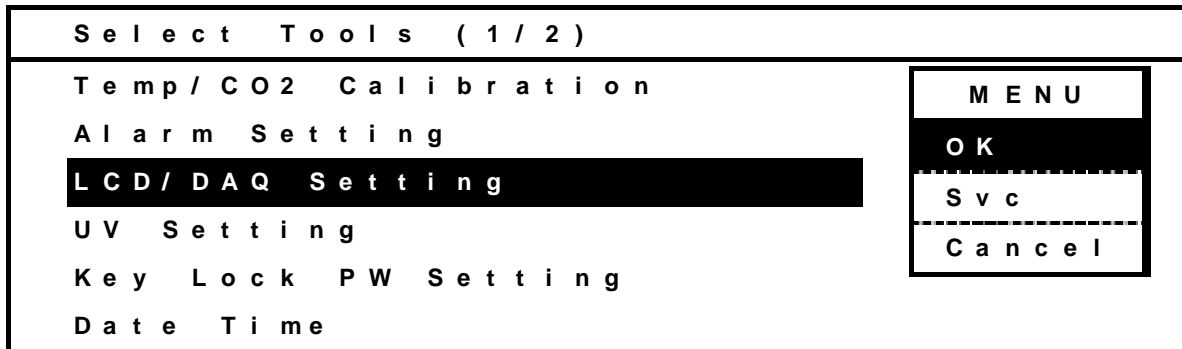

2. The LCD/DAQ Setting Display will appear. Set the initial setting for each parameter as necessary.

L C D / D A Q   S e t t i n g			
L C D   B a c k   C o l o r	<b>1</b>	( 1 . B l u e   2 . W h i t e )	
D A Q   S p e e d	0	( 0 . 2 4 0 0   2 . 9 6 0 0 )	
D A Q   I D	0	( 0 . O F F   1 - 2 5 0 )	
D A Q   M o d e	0	( 0 . L o c a l   1 . R e m o t e )	
R e m o t e   A l a r m	1	( 0 . O F F   1 . A c t i v e )	

• **LCD Back Color:** Setting of the background color (1: Blue, 2: White)

**Note:**

DAQ is an external monitoring system of the chamber status. It is necessary to set the DAQ speed, DAQ ID, and DAQ mode to use the optional communications software. Communications software is an optional accessory. Contact a Sanyo sales representative or agent for details.

# DISPLAYING THE LOG

A log of the past chamber temperatures, CO<sub>2</sub> densities and O<sub>2</sub> densities can be displayed on a graph.

1. Press the MENU Key from the Top Display to display the menu, select **Log** and press the ENTER Key.

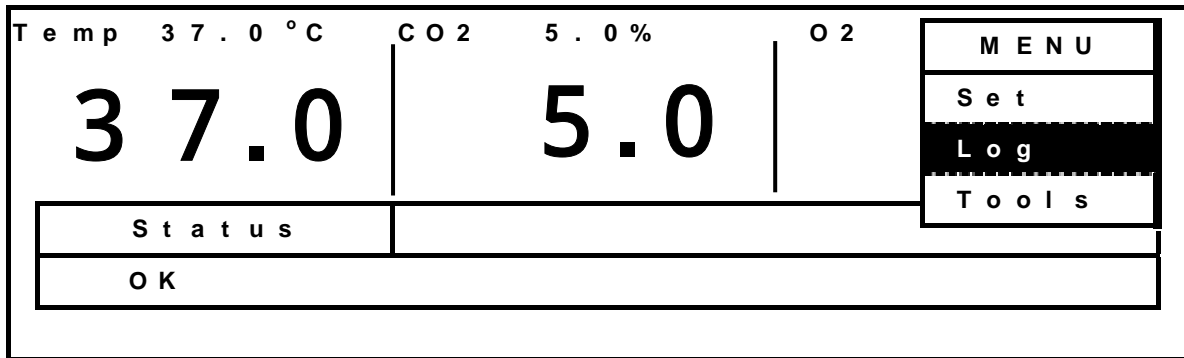

2. The log will be displayed with dots. Press the Up Cursor Key and Down Cursor Key to switch between the temperature, CO<sub>2</sub> density and O<sub>2</sub> density displays. Press the Left Cursor Key and Right Cursor Key to scroll the displayed data (Left Cursor Key: older data, Right Cursor Key: newer data).

Temperature

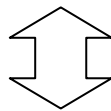
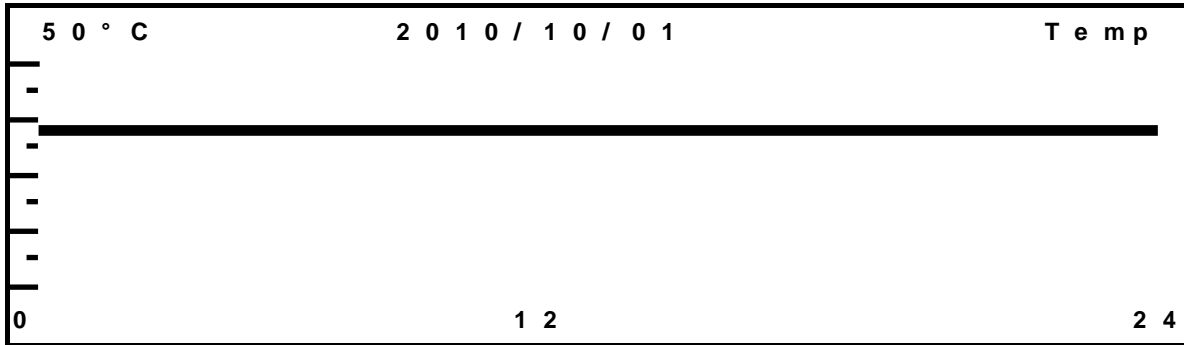

Switched with Up and Down Cursor

CO<sub>2</sub> density

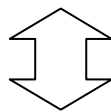
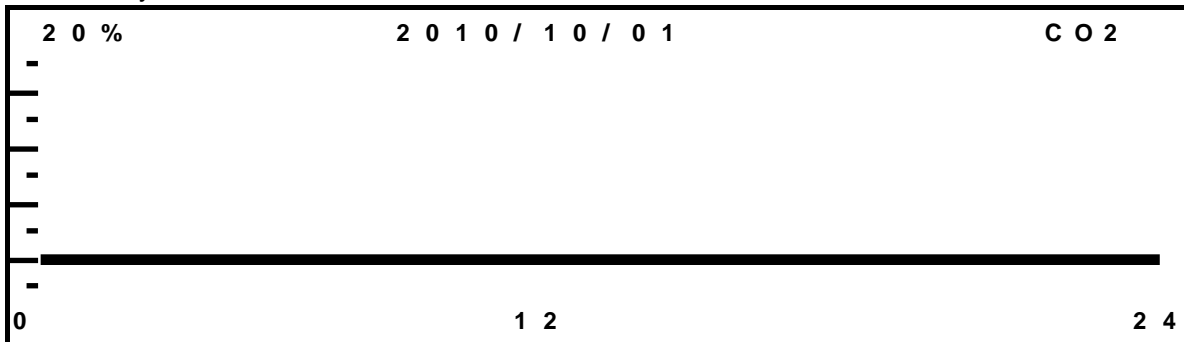

Switched with Up and Down Cursor

O<sub>2</sub> density

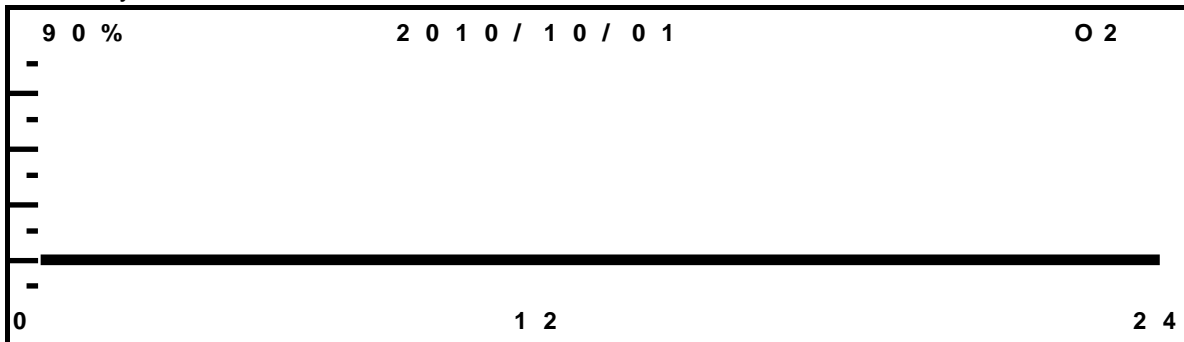

## Transferring data

Use the following procedure to transfer the log data to a PC.

1. To transfer the log data for one day, press the MENU Key to display the menu, select **PC 1D**, and press the ENTER Key. To transfer all of the log data, select **PC All** and press the ENTER Key.



2. A Progress Display will appear. On a HyperTerminal on PC, specify a transfer, text capture, and the name of the file to save. Use TXT or CSY as the file name extension. Press the MENU Key to display the menu, select **Start**, and press the ENTER Key.

The transfer will be started. "Finished" will be displayed when the transfer has been completed. Select **Cancel** from the menu after the transfer has been completed and press the ENTER Key.

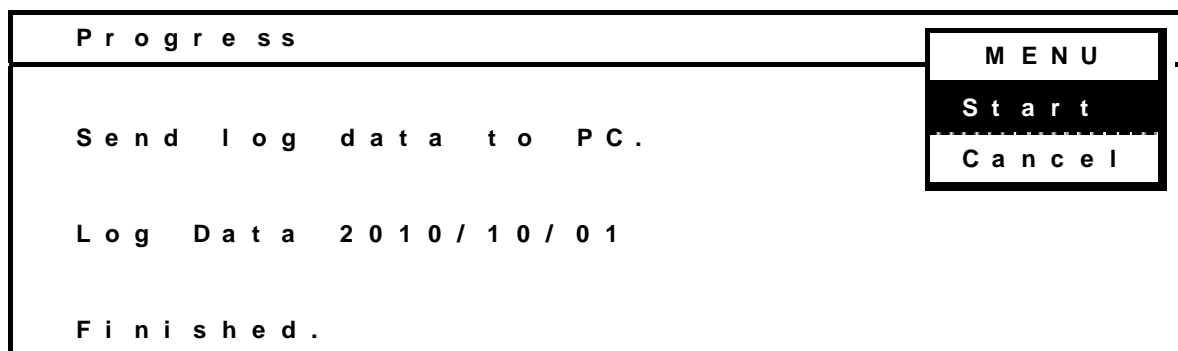

### Setting in PC side for transmission of log data (For Windows 2000 and Windows XP)

1. From the Windows Start Button, select **Program - Accessories - Communications - HyperTerminal** to start the HyperTerminal. (If the HyperTerminal is not available from the Start Menu, execute the following file: C:\Program Files\Windows NT\hypertm.exe.)

2. In the HyperTerminal Window, set a new connection, the name (for example, Sanyo), connection settings, method of connection, COM1, properties of COM1, and port.

Baud rate: 9,600, Data bits: 8, Parity: None, Stop bits: 1, Flow control: Xon/Xoff.

(The communications condition of the Incubator will be set automatically to the above settings when the Progress Display appears.)

**Note:** An optional RS232C/RS485 Interface MTR-480 (RS-232C/RS-485) is required to transfer data.

# WATER LEVEL SENSOR

This Incubator is equipped with a water level sensor for the humidifying pan. The sensor is set automatically when the humidifying pan is installed. Take care not to damage the sensor when removing or installing the humidifying pan.

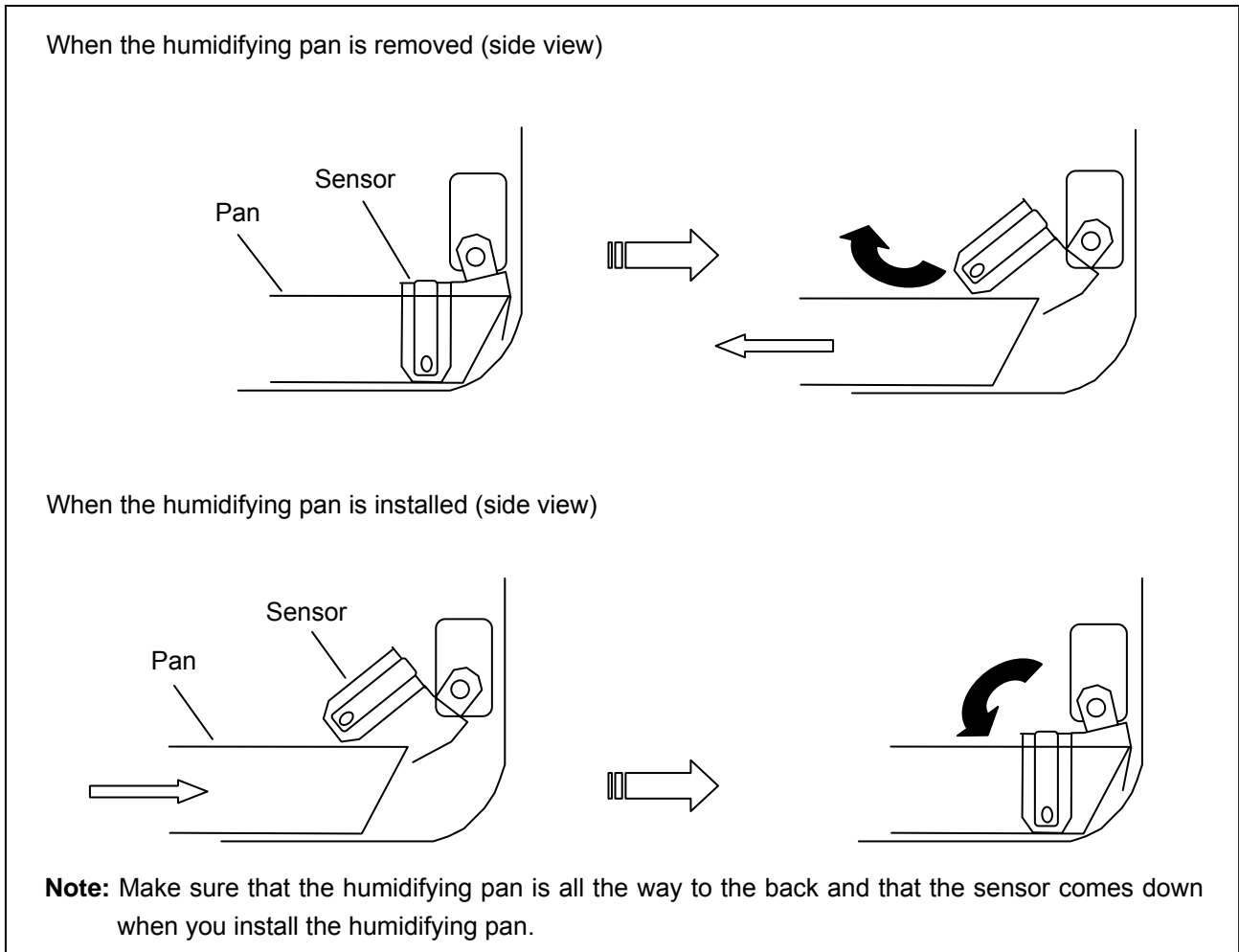

**Note:**

- Lift the sensor before installing the humidifying pan if the sensor is in the lower position after maintenance.
- When installing the humidifying pan, make sure that the pan is set properly and that sensor comes down into the pan. “RH PAN” will be displayed in reverse video in the status display field on LCD panel if the sensor does not come down completely. If necessary, set the pan again in the proper location.
- The sensor detects the water level every 30 minutes and just after the outer door is closed. It takes several seconds to detect the water level. Therefore, “RH PAN” may displayed in reverse video several times in the status display field on LCD panel after the outer door is closed even when the humidifying pan is full.

## **⚠ CAUTION**

Foreign particles on the water surface can adhere to the water level sensor and fittings by capillary action because the sensor is always in the water. The adhered foreign particles degrade sensor performance and “RH PAN” may displayed in reverse video in the status display field on LCD panel even though there is sufficient water in the humidifying pan. Be sure to wipe OFF any dirt on the water level sensor with disinfectant alcohol whenever you change the humidifying water. When cleaning the sensor, take care not to apply excessive force to the lead wires.

# ROUTINE MAINTENANCE

## Cleaning the chamber and inner attachments

When using the Incubator for the first time or when performing H<sub>2</sub>O<sub>2</sub> decontamination, refer to *Removing Chamber Attachments* on the following page and remove and clean the inner attachments.

### **⚠ WARNING**

Before performing any repairs or maintenance, **turn OFF the power switch and unplug the Incubator.** Failure to do so may result in electric shock or injury.

**Be careful not to inhale chemicals, vapors or aerosols when cleaning the Incubator.** Doing so may be harmful to health.

### **⚠ CAUTION**

**Wear rubber gloves when performing maintenance on the chamber.** Failure to wear gloves may result in cuts or abrasions from sharp edges or corners.

#### **Note:**

Be careful not to damage the humidifying pan water level sensor or the UV lamp in the chamber duct (if the MCO-19M(UVH)/19M(UV) or the optional MCO-19UVS is installed).

Do not use detergents or antiseptic solutions with acid, alkali, or chlorine. Doing so may cause discoloration, corrosion, or rusting.

1. Close the valve of the CO<sub>2</sub> and N<sub>2</sub>/O<sub>2</sub> gas cylinder and turn off the power to the incubator.

2. Open the outer and inner doors and pull out the all trays. (See Fig. 1.)

**Note:** Open the inner door after closing all gastight split doors.

3. Lift the front of the tray supports and pull them out. (See Fig. 2.)

4. Lift the humidifying pan cover off from the pins on the rear side. (See Fig. 3.)

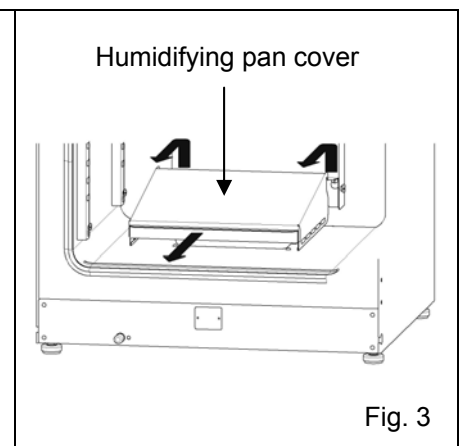
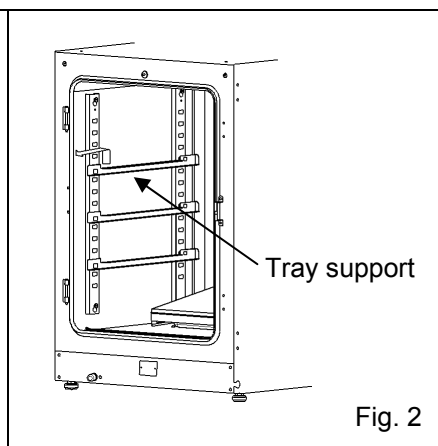
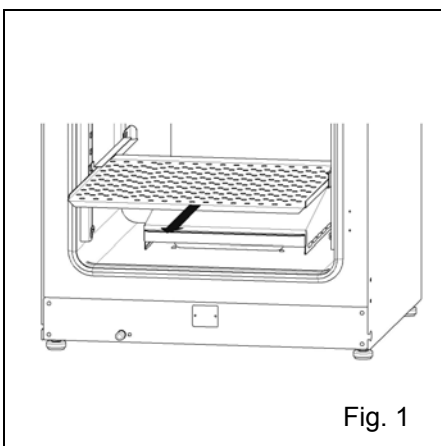

5. Pull out the N<sub>2</sub>/O<sub>2</sub> gas injection nozzle and N<sub>2</sub>/O<sub>2</sub> gas injection nozzle tube. (See Fig. 4.)
6. Pull out the humidifying pan. (See Fig. 5.)
7. Loosen the two screws securing the fan cover and take off the fan cover. (See Fig. 6.)

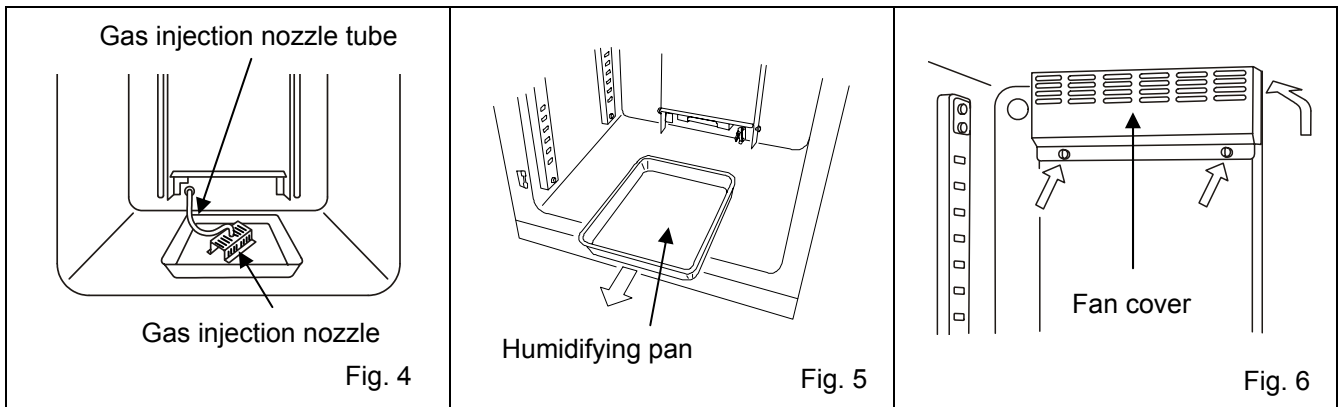

8. Lift the duct and remove it from the pins on the rear side. (See Fig. 7.)
9. Remove the chamber circulation fan by pulling out the central spring and then by pulling out the fan. (See Fig. 8.)
10. Remove the screw securing the clamp for the side support and remove the clamp. (See Fig. 9.)
11. Lift the tray brace off of the pins. (See Fig. 10.)

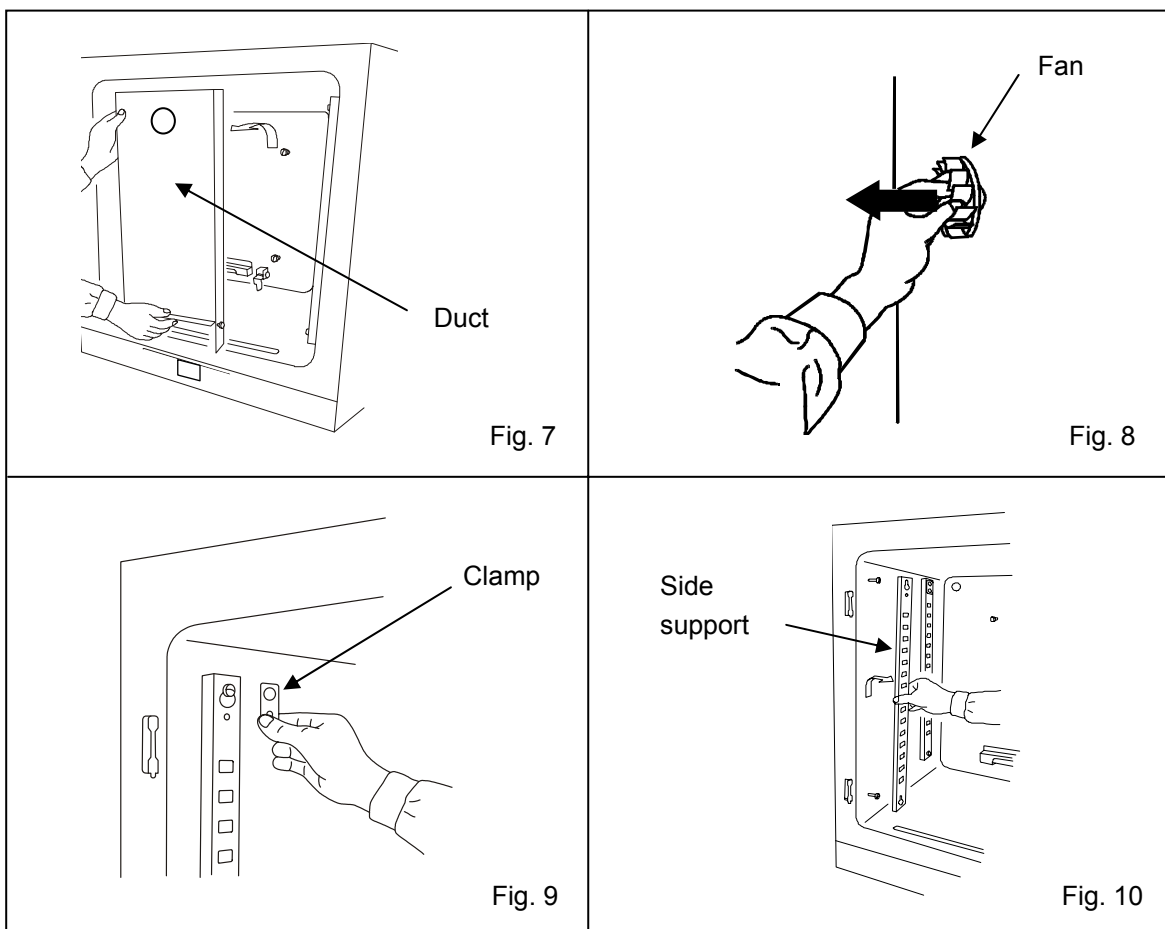

12. Clean all the attachments with a diluted neutral detergent, and then rinse them thoroughly with distilled water.

13. Wipe the trays, the inner attachments such as the chamber circulation fan, and the chamber sides with sterilizing alcohol. Be careful not to leave any residual alcohol.

14. Wipe the water level sensor with sterilizing alcohol. Be careful not to leave any residual alcohol. When cleaning the sensor, take care not to apply excessive force to the lead wires.

15. To reinstall all the attachments, perform the procedure in reverse order from step 14.

**Note:**

- When installing the fan, insert it securely on the motor shaft (See Fig.11). Lightly turn the fan manually to make sure that it does not strike the rear panel. Improper insertion may cause poor performance.
- As shown in Fig. 12, set the tray with only the front edge bent down. If the tray is set in the wrong direction, it may not be level and may become unstable.

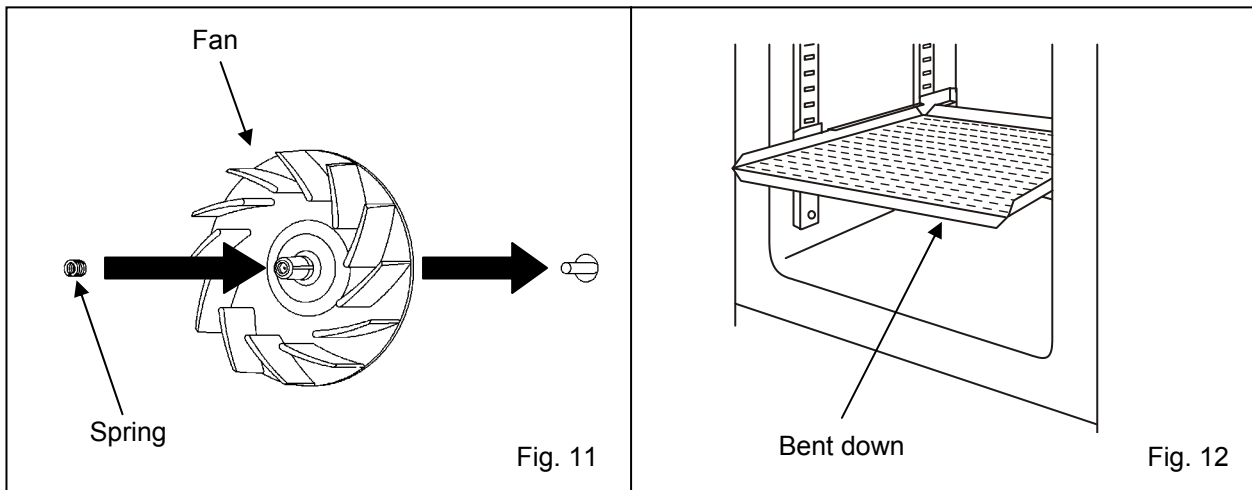



## Filling the humidifying pan

Use the following procedure to fill the humidifying pan or to replace the water.

1. Lift the humidifying pan cover. (See Fig. 1.)
2. Pull the humidifying pan forward. (See Fig. 2.)
3. Dispose of the remaining water in the pan and clean the pan with a neutral dishwashing detergent. Then rinse it thoroughly with distilled water and wipe it with sterilizing alcohol.
4. Wipe all moisture from the bottom of the chamber.
5. Return the pan to the chamber and add sterile distilled water (approx. 1.5 L, preheated to 37°C). (See Fig. 3.)
6. Set the pan with the inner side flush against the back, and replace the cover. Close all gastight split doors, inner door and outer door, and confirm that RH PAN is not displayed in reverse video in the status display area.

### Note:

- Preheat to 37°C the water to be added to the humidifying pan. Adding low-temperature water will lower the temperature and humidity in the chamber.
- If the water level alarm indication "RH PAN" is displayed, use the above procedure to replenish the water.

### **⚠ CAUTION**

When refilling the water in the humidifying pan, **always wipe off any dirt from the water level sensor with sterilizing alcohol**. While doing that, be careful not to apply excessive force to the sensor lead wire.

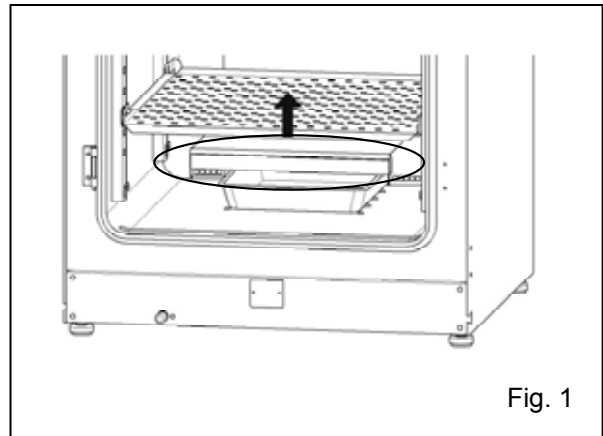

Fig. 1

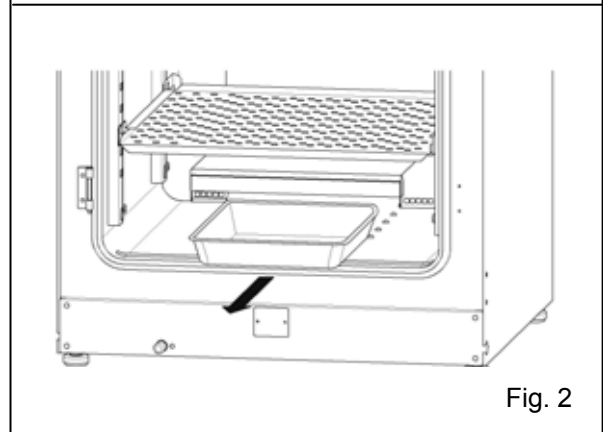

Fig. 2

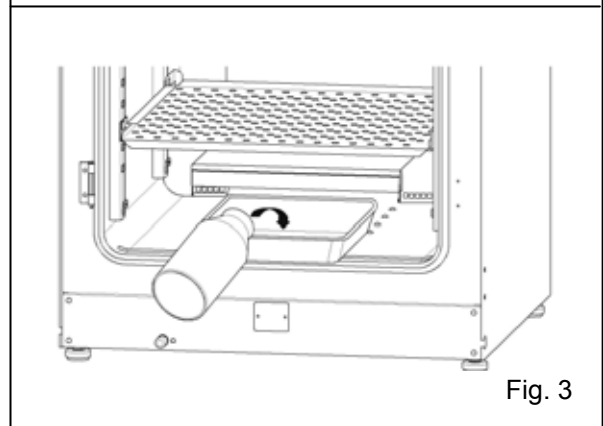

Fig. 3

# H<sub>2</sub>O<sub>2</sub> DECONTAMINATION

When the chamber has been contaminated, or when cleaning the chamber prior to starting a culture, H<sub>2</sub>O<sub>2</sub> decontamination can be performed using the H<sub>2</sub>O<sub>2</sub> Generator.

- The following products must be purchased separately in order to perform H<sub>2</sub>O<sub>2</sub> decontamination. Before performing H<sub>2</sub>O<sub>2</sub> decontamination, check to make sure that these are correctly installed.
  - UV Lamp Expansion Kit (MCO-19UVS) (Not required for the MCO-19M(UV).)
  - H<sub>2</sub>O<sub>2</sub> Decontamination Kit (MCO-HL)
  - H<sub>2</sub>O<sub>2</sub> Generator (MCO-HP)
- The H<sub>2</sub>O<sub>2</sub> decontamination function decontaminates the chamber and the inner attachments. Do not place any objects other than the specified attachments in the chamber during decontamination.
- Before performing H<sub>2</sub>O<sub>2</sub> decontamination, clean the chamber and the inner attachments with sterilizing alcohol.
- The chamber temperature during H<sub>2</sub>O<sub>2</sub> decontamination reaches 45°C. Before performing H<sub>2</sub>O<sub>2</sub> decontamination, set the upper limit temperature alarm to 50°C or higher.
- For the H<sub>2</sub>O<sub>2</sub> reagent, use one bottle of the H<sub>2</sub>O<sub>2</sub> Decontamination Reagent specified by Sanyo (MCO-H202).
- After decontamination, dilute the residual H<sub>2</sub>O<sub>2</sub> Decontamination Reagent in the H<sub>2</sub>O<sub>2</sub> Generator with a large quantity of water and dispose of it, and rinse with distilled water. (Do not wash either the inside or outside of the H<sub>2</sub>O<sub>2</sub> Generator with alcohol.)

## WARNING

Use the reagent specified by Sanyo for H<sub>2</sub>O<sub>2</sub> decontamination. Using a different H<sub>2</sub>O<sub>2</sub> solution may cause explosion or damage to the Incubator, or insufficient decontamination.

**Do not use chemicals other than the H<sub>2</sub>O<sub>2</sub> reagent, such as alcohol.** Doing so may result in damage to the H<sub>2</sub>O<sub>2</sub> Generator.

## WARNING

When performing H<sub>2</sub>O<sub>2</sub> decontamination, **make sure that gastight split doors, inner door and outer door are securely closed.** During H<sub>2</sub>O<sub>2</sub> decontamination, plug the access hole with the silicon cap that is provided. Failure to do so may be harmful to health due to leakage of H<sub>2</sub>O<sub>2</sub> gas.

## CAUTION

H<sub>2</sub>O<sub>2</sub> decontamination can be performed only for the chamber and chamber attachments with standard specifications, and not for any other objects.

 **CAUTION**

Perform H<sub>2</sub>O<sub>2</sub> decontamination with the chamber attachments arranged as specified by Sanyo. Arranging them in a different way may result in insufficient decontamination.

 **CAUTION**

Wear rubber gloves when handling the H<sub>2</sub>O<sub>2</sub> reagent. Direct contact with the H<sub>2</sub>O<sub>2</sub> reagent may result in inflammation of the skin.

 **CAUTION**

After H<sub>2</sub>O<sub>2</sub> decontamination has been completed, residual H<sub>2</sub>O<sub>2</sub> solution will remain on the bottom of the chamber, the H<sub>2</sub>O<sub>2</sub> Generator, and the bottom of the duct. **Wearing protective glasses and rubber gloves, wipe it off with a non-woven cloth.** Failure to do so may result in a deficient culture.

# H<sub>2</sub>O<sub>2</sub> decontamination

Use the following procedure to perform H<sub>2</sub>O<sub>2</sub> decontamination using the H<sub>2</sub>O<sub>2</sub> Generator (MCO-HP).

1. Take out all trays, tray supports, side supports, the humidifying pan cover, the N<sub>2</sub> or O<sub>2</sub> gas injection nozzle, the N<sub>2</sub> or O<sub>2</sub> gas injection nozzle tube, the humidifying pan, the fan cover, and the duct from the chamber. Dispose of the water in the humidifying pan, wipe the inside walls of the chamber with a gauze containing water or alcohol for sterilization.
2. Attach the duct and side supports, and set the tray supports in the 2nd, 5th, 9th holes from the top of the side supports. Then set the trays.
3. Pour one bottle of H<sub>2</sub>O<sub>2</sub> Decontamination Reagent (MCO-H2O2) into the H<sub>2</sub>O<sub>2</sub> Generator. Set the two pins on the H<sub>2</sub>O<sub>2</sub> Generator in the 2 holes on the lower left side of the duct (Fig. 1).
4. Connect the H<sub>2</sub>O<sub>2</sub> Generator and connector on the bottom right of the far side of the chamber with the enclosed cable. Be sure to keep the connector cap (Fig. 1).
5. Set the humidifying pan cover, humidifying pan, fan cover, the N<sub>2</sub> or O<sub>2</sub> gas injection nozzle and the N<sub>2</sub> or O<sub>2</sub> gas injection nozzle tube as shown in Fig. 2, and close the inner door and outer door .  
**Note:** The trays included as accessory are designed to be appropriate for decontamination. If Half Trays (MCO-25ST, optional) or Trays for previous models are used, decontamination may not be sufficiently effective.

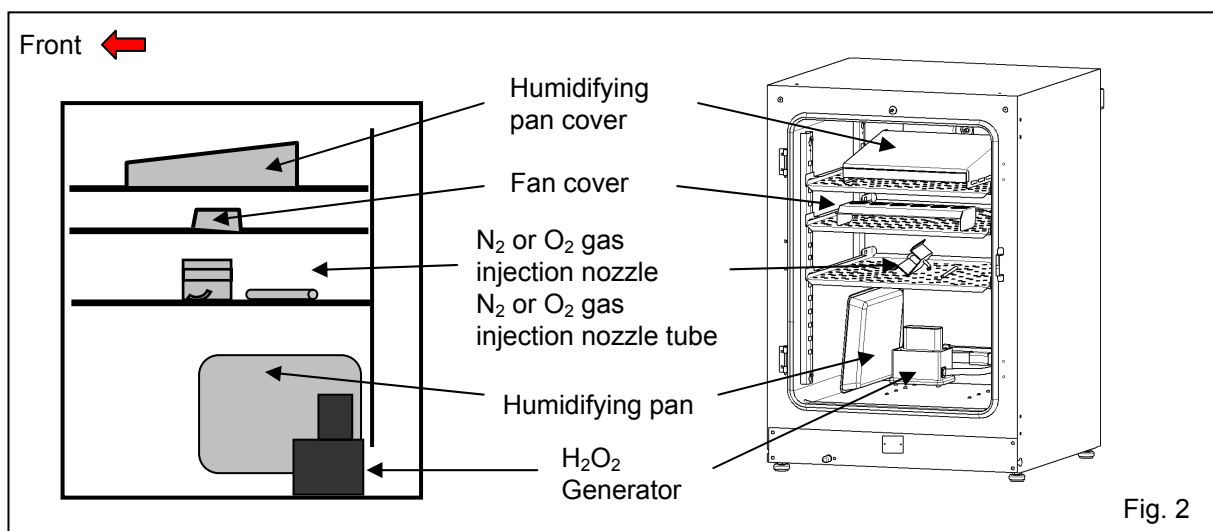
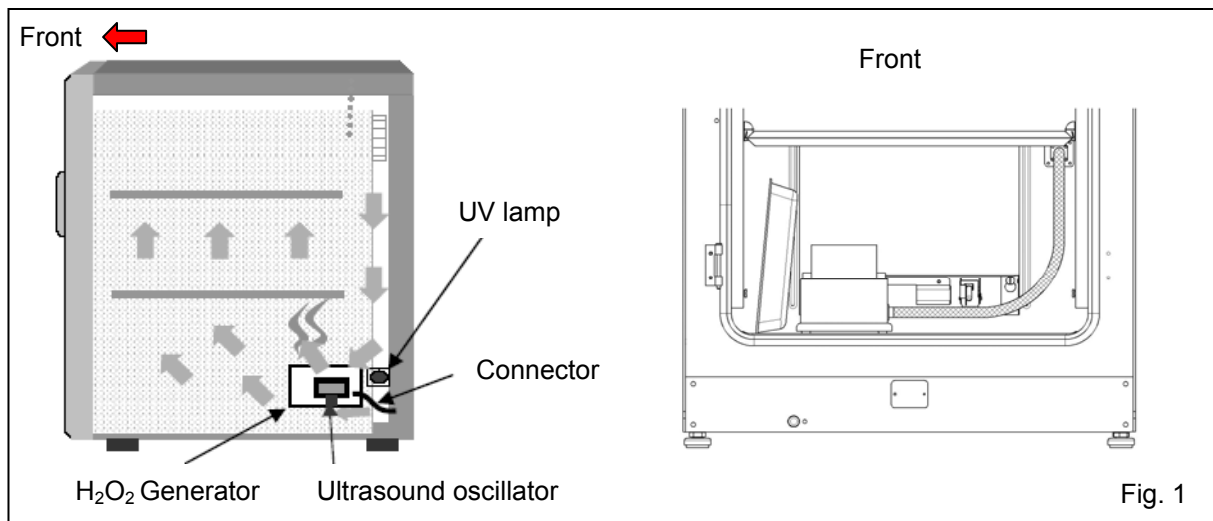

6. Press the H<sub>2</sub>O<sub>2</sub> Key for 3 seconds. The system check will start.

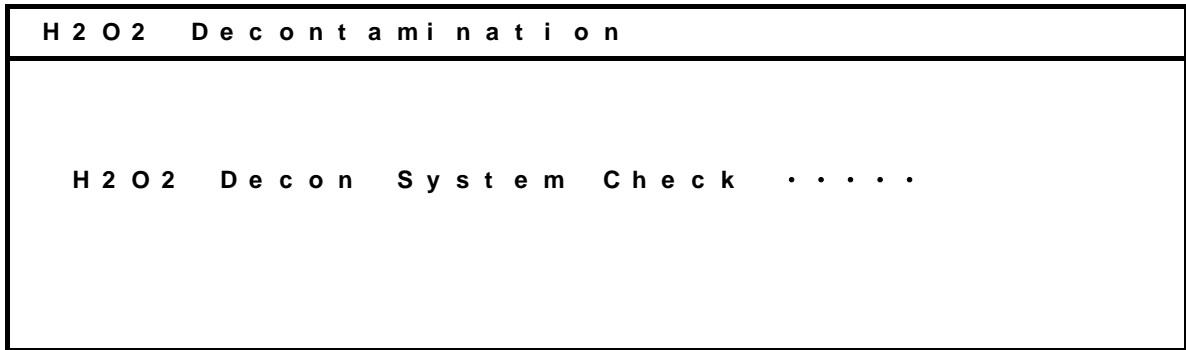

7. If the system is normal, the following display will appear. (If the system is not normal, refer to Table 2 on page 57.) Select **OK** and press the ENTER Key to start H<sub>2</sub>O<sub>2</sub> decontamination. Decontamination will be performed automatically to step 10. The buzzer will sound when decontamination has been completed (It takes about 1 hour 40 minutes after warming-up).

**Note:** The outer door will be locked with an electric lock for safety until the decontamination has been completed.

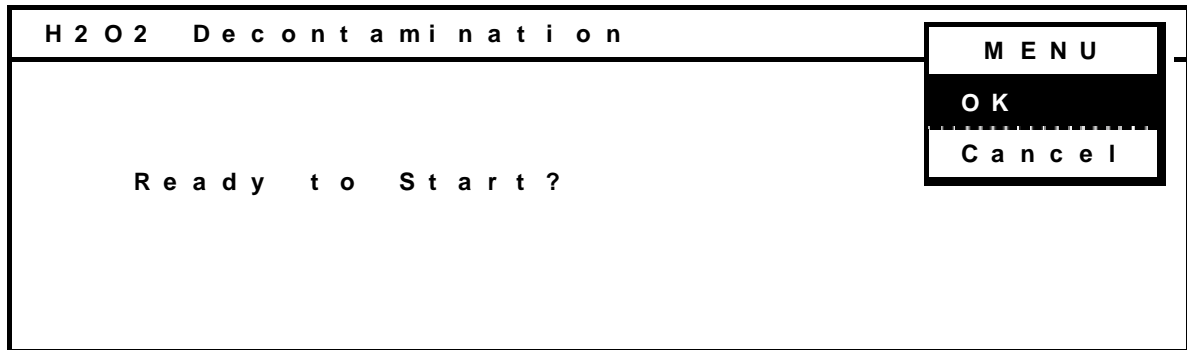

8. During the H<sub>2</sub>O<sub>2</sub> mist generation, "H<sub>2</sub>O<sub>2</sub> Decon" will flash at the top left corner of the screen.

**Note:** H<sub>2</sub>O<sub>2</sub> mist generates from the H<sub>2</sub>O<sub>2</sub> Generator and then quickly changes to a gas.

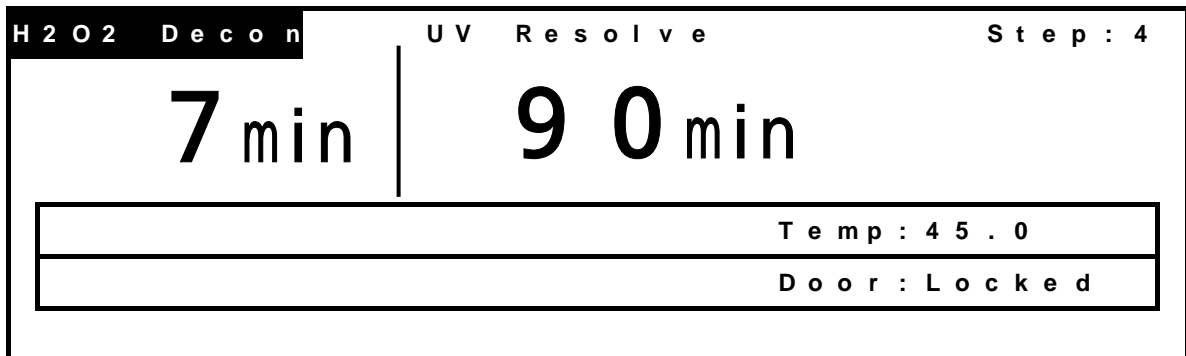

9. After completion of H<sub>2</sub>O<sub>2</sub> mist generation, “UV Resolve” will flash at the top of the screen, and H<sub>2</sub>O<sub>2</sub> gas resolution by UV light will start.



10. After H<sub>2</sub>O<sub>2</sub> gas resolution, H<sub>2</sub>O<sub>2</sub> decontamination has been completed. The following display will appear. Open the outer door and disconnect the cable of H<sub>2</sub>O<sub>2</sub> Generator from the connector in the chamber. Then take out the H<sub>2</sub>O<sub>2</sub> Generator.

**Note:** Always put on protection glasses and rubber gloves when performing decontamination.

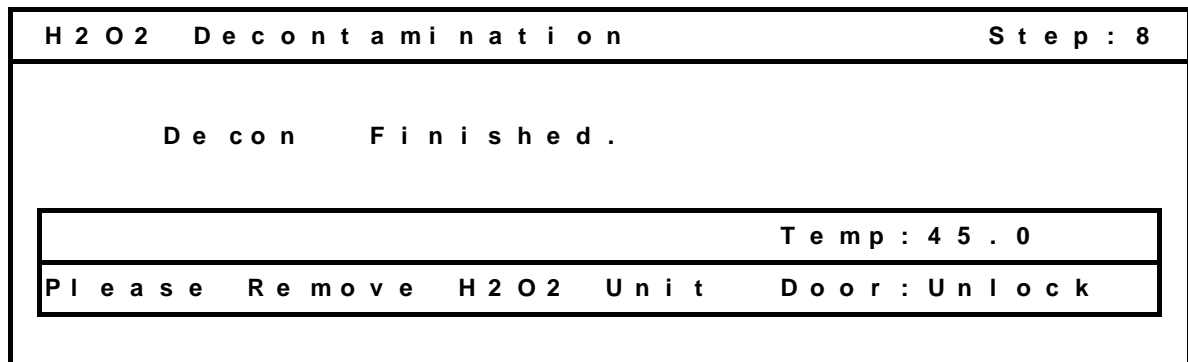

11. The following display will appear. Press the MENU Key to display the menu, select **OK**, and press the ENTER Key to return to the Top Display.

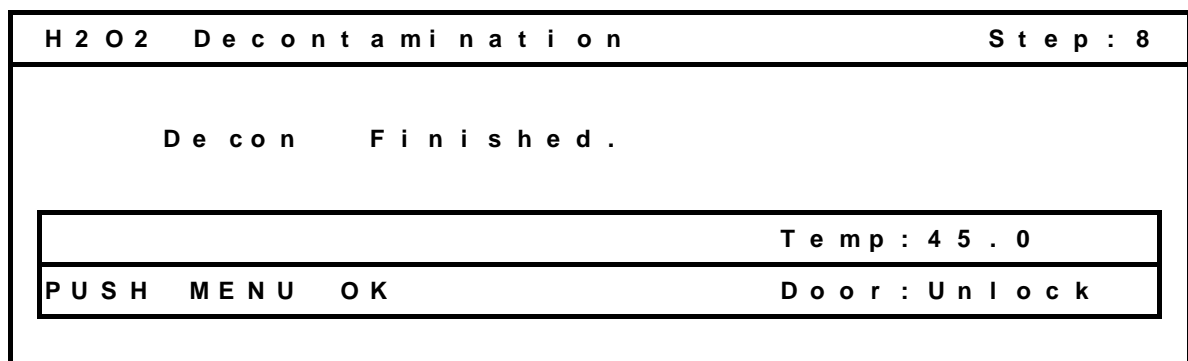

12. Dilute the remaining H<sub>2</sub>O<sub>2</sub> reagent in the H<sub>2</sub>O<sub>2</sub> Generator with a large volume of water and dispose of it. Rinse and wash the H<sub>2</sub>O<sub>2</sub> Generator with distilled water. Then keep the H<sub>2</sub>O<sub>2</sub> Generator in a clean environment outside of the chamber.

**Note:** After H<sub>2</sub>O<sub>2</sub> decontamination, cover the connector on the chamber side with the connector cap.

13. After H<sub>2</sub>O<sub>2</sub> decontamination, surplus H<sub>2</sub>O<sub>2</sub> liquid will remain at the bottom of the chamber and in the bottom part of the H<sub>2</sub>O<sub>2</sub> Generator duct. This solution contains H<sub>2</sub>O<sub>2</sub> at a low concentration (about 1% or less), so put on protective glasses and rubber gloves and wipe it up with a non-woven cloth.

14. Ventilate the chamber sufficiently and place all the attachments back into the chamber.

**Note:** Be sure to attach the connector cap.

### CAUTION

The electric lock will remain locked if power fails during H<sub>2</sub>O<sub>2</sub> decontamination. After the power comes back ON, the H<sub>2</sub>O<sub>2</sub> gas resolution process will start execution and finish automatically. Execute the decontamination again because the decontamination will be incomplete.

### WARNING

Never open the door by unlocking it with the unlock key during H<sub>2</sub>O<sub>2</sub> decontamination or H<sub>2</sub>O<sub>2</sub> gas resolution with the UV lamp. H<sub>2</sub>O<sub>2</sub> gas leakage is potentially harmful to health.

## Precautions when handling H<sub>2</sub>O<sub>2</sub> decontamination reagent

Observe the following precautions when handling the H<sub>2</sub>O<sub>2</sub> Decontamination Reagent (MCO-H2O2).

### ● Handling Precautions

- Wear protective equipment, such as protective glasses and rubber gloves.
- Do not use fire in the area where the reagent is being handled.
- Do not leave any reagent in the container after it has been used or while it is being used.
- Do not place inflammable or combustible materials near the area where the reagent is handled.

### ● Precautions for Storage

- Always close the container cover securely to prevent impurities from becoming mixed in the reagent.
- Check the container to make sure that there is no damage, corrosion, or cracking.
- Store the container with the inlet facing upwards, and make sure that the container will not tip or be knocked over.
  - If possible, store the reagent in a location where water is available and where the floor can be easily washed.

### ● Precautions for Disposal

- Dispose according to the rule in your country.

# ALARMS, SAFETY, AND SELF-DIAGNOSIS

The Incubator supports the following alarms, safety functions, and self-diagnostic functions.

**Table 1: Alarms and Safety Functions for Culture Operations**

Alarm or safety function	Conditions	Display	Buzzer	Safety operation
Upper limit temperature alarm	The chamber temperature exceeds the upper limit alarm temperature set value.	OVERHEAT indicator lights.	Continuous tone	Heater OFF Remote alarm operates
Automatic set temperature alarm	The chamber temperature is out of the automatic set temperature alarm setting range ( $\pm 1.0$ to $\pm 5.0^\circ\text{C}$ ).	<i>Warning :High Temp</i> or <i>Warning :Low Temp</i> is displayed in the message display field.	Intermittent tone after set alarm delay time (0 to 15 min) has elapsed	Remote alarm operates after delay of 0 to 15 min.
Automatic set CO <sub>2</sub> concentration alarm	The chamber CO <sub>2</sub> concentration is out of the automatic set CO <sub>2</sub> concentration alarm setting range ( $\pm 0.5\%$ to $\pm 5.0\%$ ).	<i>Warning :High CO<sub>2</sub> Density</i> or <i>Warning :Low CO<sub>2</sub> Density</i> is displayed in the message display field.	Intermittent tone after set alarm delay time (0 to 15 min) has elapsed	Remote alarm operates after delay of 0 to 15 min.
Automatic set O <sub>2</sub> concentration alarm	The chamber O <sub>2</sub> concentration is out of the automatic set CO <sub>2</sub> concentration alarm setting range ( $\pm 0.5\%$ to $\pm 5.0\%$ ).	<i>Warning :High O<sub>2</sub> Density</i> or <i>Warning :Low O<sub>2</sub> Density</i> is displayed in the message display field.	Intermittent tone after set alarm delay time (0 to 30 min) has elapsed	Remote alarm operates after delay of 0 to 30 min.
Auto-return	There are no key operations for approx. 90 s in a setting mode.	Top screen is displayed.	----	The setting mode is canceled.
Key lock	The key lock is ON.	<i>Key Lock</i> is displayed on the standby operation setting screen.	----	Setting changes are prohibited.
Door alarm	The outer door is open.	<i>Door : Open</i> is displayed in the message display field.	Intermittent tone after set alarm delay time (1 to 30 min) has elapsed	The CO <sub>2</sub> valve is closed. The N <sub>2</sub> /O <sub>2</sub> valve is closed. The heater turns OFF after 1 min.
CO <sub>2</sub> gas cylinder empty	The CO <sub>2</sub> concentration does not increase when the CO <sub>2</sub> valve is opened.	<i>Err01: CO<sub>2</sub> Gas Empty</i> is displayed in the message display field.	Intermittent tone	Remote alarm operates.
N <sub>2</sub> (or O <sub>2</sub> ) gas cylinder empty	The O <sub>2</sub> concentration does not increase when the N <sub>2</sub> /O <sub>2</sub> valve is opened.	<i>Err02: N<sub>2</sub>/O<sub>2</sub> Gas Empty</i> is displayed in the message display field.	Intermittent tone	Remote alarm operates.
CO <sub>2</sub> line changeover	The CO <sub>2</sub> gas supply is switched automatically to the reserve cylinder (only when the MCO-21GC is installed).	<i>Err01: CO<sub>2</sub> Gas Empty</i> is displayed in the message display field. The text flashes for the empty CO <sub>2</sub> gas supply line.	"	The CO <sub>2</sub> gas supply is switched. Remote alarm operates.
N <sub>2</sub> (or O <sub>2</sub> ) line changeover	The N <sub>2</sub> /O <sub>2</sub> gas supply is switched automatically to the reserve cylinder.	<i>Err02: N<sub>2</sub>/O<sub>2</sub> Gas Empty</i> is displayed in the message display field. The text flashes for the empty N <sub>2</sub> /O <sub>2</sub> gas supply line.	"	The N <sub>2</sub> /O <sub>2</sub> gas supply is switched. Remote alarm operates.
Connection mistake of CO <sub>2</sub> line and N <sub>2</sub> (or O <sub>2</sub> ) line	The CO <sub>2</sub> concentration keeps increasing when the CO <sub>2</sub> valve is closed.	<i>Err03: CO<sub>2</sub> Gas Connect Abnormal</i> is displayed in the message display field.	"	The CO <sub>2</sub> valve is closed. The N <sub>2</sub> /O <sub>2</sub> valve is closed.
Selection Mistake of N <sub>2</sub> gas and O <sub>2</sub> gas.	The O <sub>2</sub> concentration keeps keep changing into the opposite direction when the N <sub>2</sub> /O <sub>2</sub> valve is opened.	<i>Err04: N<sub>2</sub>/O<sub>2</sub> Gas Connect Abnormal</i> is displayed in the message display field.	"	The CO <sub>2</sub> valve is closed. The N <sub>2</sub> /O <sub>2</sub> valve is closed.
Chamber temperature sensor error	The chamber temperature sensor is disconnected.	<i>Err05: Temp Sensor Open</i> is displayed in the message display field.	"	The heater turns OFF. Remote alarm operates.
	The chamber temperature sensor is short-circuited.	<i>Err06: Temp Sensor Short</i> is displayed in the message display field.	"	The heater turns OFF. Remote alarm operates.
Sensor box temperature sensor error	The sensor box temperature sensor is disconnected.	<i>Err07: CO<sub>2</sub>S Box Temp Sensor Open</i> is displayed in the message display field.	"	CO <sub>2</sub> valve is closed. Remote alarm operates.
	The sensor box temperature sensor is short-circuited.	<i>Err08: CO<sub>2</sub>S Box Temp Sensor Short</i> is displayed in the message display field.	"	CO <sub>2</sub> valve is closed. Remote alarm operates.
Ambient temperature sensor error	The ambient temperature sensor is disconnected.	<i>Err09: AT Sensor Open</i> is displayed in the message display field.	"	Remote alarm operates.
	The ambient temperature sensor is short-circuited.	<i>Err10: AT Sensor Short</i> is displayed in the message display field.	"	Remote alarm operates.
CO <sub>2</sub> sensor error	The Vref or Vgas output voltage for the CO <sub>2</sub> sensor is abnormal.	<i>Err11: CO<sub>2</sub> Sensor Vref Abnormal</i> or <i>Err12: CO<sub>2</sub> Sensor Vgas Abnormal</i> is displayed in the message display field.	"	CO <sub>2</sub> valve is closed. Remote alarm operates.



Alarm or safety function	Conditions	Display	Buzzer	Safety operation
O <sub>2</sub> sensor error	The measured voltage for the O <sub>2</sub> sensor is abnormal.	<i>Err19: O<sub>2</sub> Sensor Abnormal</i> is displayed in the message display field.	Intermittent tone	N <sub>2</sub> /O <sub>2</sub> valve is closed. Remote alarm operates
Main heater error	Main heater burnout occurs or the main heater SSR is short-circuited when the upper limit temperature alarm operates.	<i>Err13: Main Heater Abnormal</i> is displayed in the message display field.	"	Remote alarm operates.
Bottom heater error	Bottom heater burnout occurs or the bottom heater SSR is short-circuited.	<i>Err14: Humidity Heater Abnormal</i> is displayed in the message display field.	"	Remote alarm operates.
Door heater error	Door heater burnout occurs or the door heater SSR is short-circuited.	<i>Err15: Door Heater Abnormal</i> is displayed in the message display field.	"	Remote alarm operates.
Sensor box heater error	Sensor box heater burnout occurs or the sensor box heater SSR is short-circuited.	<i>Err16: CO<sub>2</sub>S Box Heater Abnormal</i> is displayed in the message display field.	"	Remote alarm operates.
Heater SSR burnout	Main, bottom, door, or sensor box heater SSR burnout occurs.	<i>Err17: Heater SSR Open</i> is displayed in the message display field.	"	Remote alarm operates.
Low humidifying water	The water in the humidifying pan drops to approx. 600 ml.	<i>RH PAN</i> flashes in reverse video in the status display field.	----	----
UV lamp failure	The UV lamp burns out (only for the MCO-19M(UVH)/19M(UV) or when the optional MCO-19UVS is installed).	<i>Err18: UV Lamp Abnormal</i> is displayed in the message display field.	Intermittent tone	Remote alarm operates.
New UV lamp recommended	The accumulated ON time reaches approx. 1,000 hours (only for the MCO-19M(UVH)/19M(UV) or when the optional MCO-19UVS is installed).	<i>Warning :UV Life</i> is displayed in the message display field.	----	----

\* The buzzer can be stopped by pressing the BUZZER Key, but remote alarms will not stop. In addition, a buzzer that sounds because of the upper limit temperature alarm cannot be stopped by pressing the BUZZER Key.

\* Err01 recovery is achieved automatically by correctly connecting the gas and pressing the BUZZER Key to stop the buzzer. In addition, when the MCO-21GC is installed and the gas supply is switched to the reserve gas cylinder, press the BUZZER Key and replace the gas cylinder.

\* Err02 recovery is achieved automatically by correctly connecting the gas and pressing the BUZZER Key to stop the buzzer. In addition, when the gas supply is switched to the reserve gas cylinder, press the BUZZER Key and replace the gas cylinder.

\* For Err03, confirm whether a CO<sub>2</sub> gas cylinder is correctly connected to a connecting port A/B for CO<sub>2</sub> gas pipe. Refer to page 16

\* For Err04, confirm whether a N<sub>2</sub> (or O<sub>2</sub>) gas cylinder is correctly connected to a connecting port A/B for N<sub>2</sub>/O<sub>2</sub> gas pipe. Refer to page 17

\* If an error from Err05 to Err19 occurs (except for the upper limit temperature alarm in Err13 to Err16), then consult a Sanyo sales representative or agent.

**Table 2: Alarm and Safety Functions for H<sub>2</sub>O<sub>2</sub> Decontamination**

Alarm and safety function	Condition	Display	Buzzer	Safety operation
System check error at start of H <sub>2</sub> O <sub>2</sub> decontamination	The H <sub>2</sub> O <sub>2</sub> Generator is not connected.	<i>H2O2 Decon System Error</i> is displayed in the screen center. <i>Err31: H2O2 Unit No Connect</i> is displayed in the message display field.	----	Decontamination mode is cancelled.
	There is no H <sub>2</sub> O <sub>2</sub> solution or the H <sub>2</sub> O <sub>2</sub> level sensor has failed (or is disconnected).	<i>H2O2 Decon System Error</i> is displayed in the screen center. <i>Err32: H2O2 Level is Low</i> is displayed in the message display field.	----	Decontamination mode is cancelled.
	A door is not closed.	<i>H2O2 Decon System Error</i> displayed in the screen center. <i>Err33: Door is Open</i> is displayed in the message display field.	----	Decontamination mode is cancelled.
Failure during H <sub>2</sub> O <sub>2</sub> decontamination	The volume of H <sub>2</sub> O <sub>2</sub> generated is abnormal.	<i>Err34: H2O2 Volume</i> is displayed in the message display field.	Intermittent tone with 15min delay	Moves to UV analysis. Remote alarm operates with 15 min delay.
	Power was interrupted during H <sub>2</sub> O <sub>2</sub> decontamination.	After power is restored, <i>Err35: Power Failed</i> is displayed in the screen message display field. After completion, <i>Decon Failed</i> is displayed in the screen center.	Intermittent tone	Electrically locked during power interruption. After power is restored, moves to UV analysis. Remote alarm operates.
Failure during H <sub>2</sub> O <sub>2</sub> gas analysis by UV	The UV lamp failed during H <sub>2</sub> O <sub>2</sub> gas analysis by UV.	<i>Err36: UV Lamp Failure</i> is displayed in the message display field.	Intermittent tone	UV analysis time is extended. Remote alarm operates.
	Power was interrupted during H <sub>2</sub> O <sub>2</sub> gas analysis by UV.	After power is restored, <i>Err37: Power Failed</i> is displayed in the message display field.	----	Electrically locked during power interruption. After power is restored, UV analysis is repeated.

**Table 3: Alarm and Safety Functions for automatic CO<sub>2</sub> and O<sub>2</sub> density calibration**

Alarm and safety function	Condition	Display	Buzzer	Safety operation
System check error at start/operating of automatic CO <sub>2</sub> and O <sub>2</sub> density calibration	The gas pressure for the standard gas calibration CO <sub>2</sub> gas line is less than the specified pressure.	<i>Std Gas Calib Error</i> is displayed in the screen center. <i>Err41: CO2 Std Gas Empty</i> is displayed in the message display field.	Intermittent tone	The standard gas calibration mode is cancelled. Remote alarm operates.

**Note:**

For models with electric locking, an unlock key is provided in order to unlock the door during a power interruption or in case the electric lock fails. Always store this key in a safe place. It is recommended that you make a note of the key symbol and number in case the key is lost.

 **WARNING**

**Do not use the unlock key to unlock the door during H<sub>2</sub>O<sub>2</sub> decontamination or during H<sub>2</sub>O<sub>2</sub> gas analysis by UV. Doing so may cause harm to health from H<sub>2</sub>O<sub>2</sub> gas leakage.**

# CALIBRATION

## Temperature/CO<sub>2</sub>/O<sub>2</sub> calibration

1. Press the MENU Key from the Top Display to display the menu, select **Tools**, and press the ENTER Key.

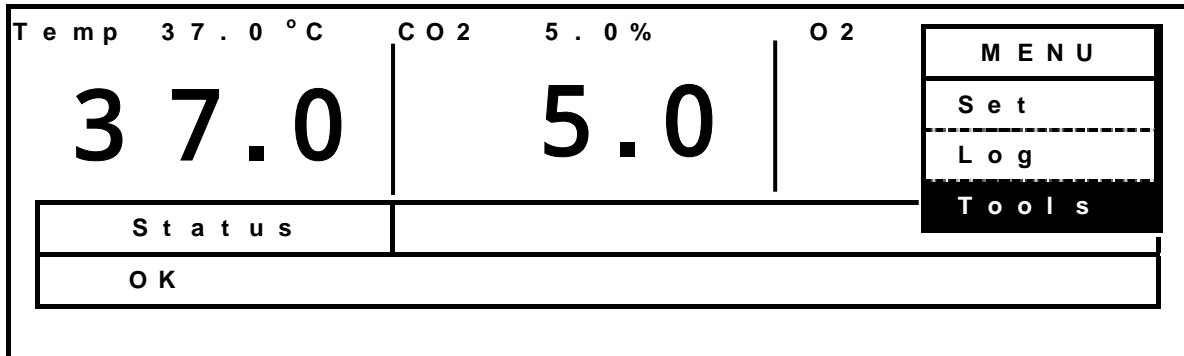

2. Select **Temp/CO<sub>2</sub>/O<sub>2</sub> Calibration** from the Select Tools Display, press the MENU Key to display the menu, select **OK**, and press the ENTER Key.

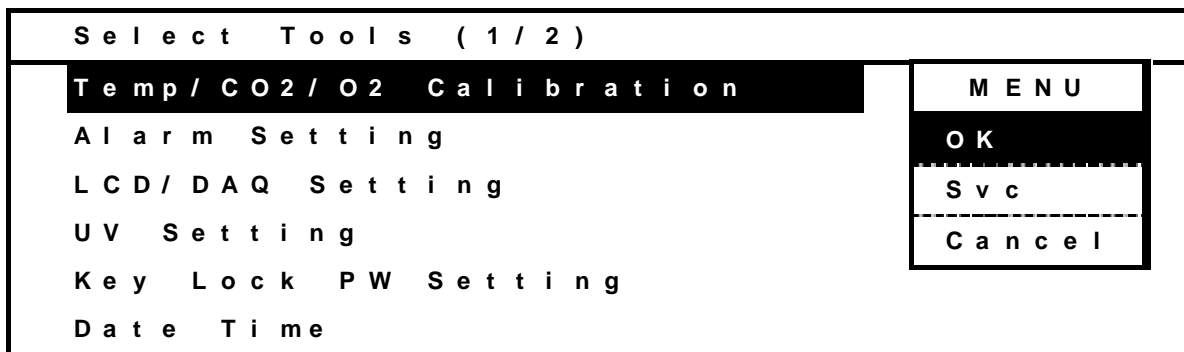

3. The Temp/CO<sub>2</sub>/O<sub>2</sub> Calibration Display will appear.

Example

Enter the value shown below if the displayed chamber temperature is 37.0°C but the actual temperature is 36.5°C.

•Temperature span: Enter 365.

Temp / CO <sub>2</sub> / O <sub>2</sub> Calibration						
			P V		V o l t	
Temp	Span	<b>36.5</b> °C	37.0 °C			0.5 °C
CO <sub>2</sub>	Zero				3.91 V	500
CO <sub>2</sub>	Span	0.0%	5.0%		3.16 V	700
O <sub>2</sub>	Zero					500
O <sub>2</sub>	Span	0.0%	5.0%		58 mV	500

Example

Enter the value shown below if the displayed chamber CO<sub>2</sub> density is 5.0% but the actual CO<sub>2</sub> density is 4.5%.

- CO<sub>2</sub> density span: Enter 045.

T e m p / C O 2 / O 2 C a l i b r a t i o n						
		P V		V o l t		
T e m p	S p a n	0 . 0 ° C	3 7 . 0 ° C			0 . 5 ° C
C O 2	Z e r o			3 . 9 1 V		5 0 0
C O 2	S p a n	4 . 5 %	5 . 0 %	3 . 1 6 V		7 0 0
O 2	Z e r o					5 0 0
O 2	S p a n	0 . 0 %	5 . 0 %	5 8 m V		5 0 0

Example

Enter the value shown below if the displayed chamber O<sub>2</sub> density is 5.0% but the actual O<sub>2</sub> density is 5.5%.

- O<sub>2</sub> density span: Enter 055.

T e m p / C O 2 / O 2 C a l i b r a t i o n						
		P V		V o l t		
T e m p	S p a n	0 . 0 ° C	3 7 . 0 ° C			0 . 5 ° C
C O 2	Z e r o			3 . 9 1 V		5 0 0
C O 2	S p a n	0 . 0 %	5 . 0 %	3 . 1 6 V		7 0 0
O 2	Z e r o					5 0 0
O 2	S p a n	5 . 5 %	5 . 0 %	5 8 m V		5 0 0

4. Press the MENU Key to display the menu, select **OK**, and press the ENTER Key.

5. After the Select Tools Display is displayed, press MENU Key to display the menu, select **Cancel**, and press the ENTER Key to return to the Top Display.

**Note:**

It is important to accurately measure the temperature inside the Incubator when calibrating the temperature. Particularly, the temperature gauge used must have an accuracy of JIS 0.5 Class or better. The temperature must be measured at several points.

The temperature setting can not change by more than  $\pm 1.0^{\circ}\text{C}$  during calibration. If these values are exceeded, an error buzzer will sound, the input data will be ignored, and the Incubator will return to the display mode. If it is necessary to change the temperature by more than  $1.0^{\circ}\text{C}$ , perform calibration in several stages over a period of time.

# TROUBLESHOOTING

If the Incubator does not seem to be working properly, check the following items before calling for service.

Symptom	Items to check and countermeasures
The Incubator does not operate at all.	<ul style="list-style-type: none"> <li>• Is the Incubator plugged in?</li> <li>• Is there a power outage, or has a circuit breaker interrupted the power?</li> </ul>
The key is not working.	<ul style="list-style-type: none"> <li>• Is the key lock function turned OFF?</li> </ul>
An alarm has occurred.	<p>When starting operation:</p> <ul style="list-style-type: none"> <li>• Does the chamber temperature match the set value?</li> <li>• Does the CO<sub>2</sub>/O<sub>2</sub> gas concentration in the chamber match the set value?</li> </ul> <p>(1) Is the secondary pressure for the CO<sub>2</sub> gas pressure regulator at the specified value of 0.03 MPaG (0.3 kgf/cm<sup>2</sup>G, 4.3 psiG)?</p> <p>(2) Is the secondary pressure for the N<sub>2</sub>/O<sub>2</sub> gas pressure regulator at the specified value of 0.05 MPaG (0.5 kgf/cm<sup>2</sup>G, 7.1 psiG)?</p> <p>(3) Is the gas tube properly connected?</p> <p>During operation:</p> <ul style="list-style-type: none"> <li>• Is the upper limit alarm temperature set at least 1°C higher than the chamber set temperature?</li> <li>• Has the temperature setting been changed? Has the door been left open for a long time? Has a low-temperature object been placed in the chamber? If any of these is the case, the alarm will be automatically cleared if you wait.</li> <li>• Has the gas tube come loose, or is there a gas leak?</li> <li>• Has the CO<sub>2</sub> /O<sub>2</sub> gas concentration setting been changed?</li> <li>• Is the gas cylinder empty? Check the primary pressure of the gas cylinder once a week. (When the primary pressure is 3.8 MPa (38 kgf/cm<sup>2</sup>G) or lower, it is a sign that there is little gas remaining. Replace the cylinder soon.)</li> </ul>
The chamber temperature does not match the set value.	<ul style="list-style-type: none"> <li>• Is the ambient temperature less than 5°C different from the set value for the chamber temperature?</li> <li>• Is the outer door closed with the gastight split doors or inner door left open?</li> </ul>
The gas concentration does not match the set value.	<ul style="list-style-type: none"> <li>• Is the secondary pressure for the CO<sub>2</sub> gas pressure regulator at the specified value of 0.03 MPaG (0.3 kgf/cm<sup>2</sup>G, 4.3 psiG)?</li> <li>• Is the secondary pressure for the N<sub>2</sub>/O<sub>2</sub> gas pressure regulator at the specified value of 0.05 MPaG (0.5 kgf/cm<sup>2</sup>G, 7.1 psiG)?</li> <li>• Is the gas tube blocked?</li> </ul>
The chamber temperature does not rise.	<ul style="list-style-type: none"> <li>• Is there enough water in the humidifying pan? (Be sure to use sterile distilled water.)</li> </ul>

Symptom	Items to check and countermeasures
A large quantity of gas is being consumed.	<ul style="list-style-type: none"> <li>• Are the doors being frequently opened and closed?</li> <li>• Check whether gas is leaking from connectors due to deterioration of the gas tube, or whether there may be any pinhole leaks. The gas tube is a replaceable part, and it is recommended that it be replaced once a year.</li> <li>• Is the packing seal for gastight split doors and inner door defective?</li> <li>• Is the access hole open?</li> </ul>
Normal cultures are not possible, and the gas concentration is suspect.	<ul style="list-style-type: none"> <li>• Is the ambient air environment around the Incubator normal? Is there a source of polluted gas in the vicinity?</li> </ul>
The gas concentration is slow to recover.	<ul style="list-style-type: none"> <li>• A HEPA filter is used for the Incubator gas piping. If gas concentration is slow to recover when the CO<sub>2</sub> gas concentration is normal, it is possible that the HEPA filter may be clogged. Consult a Sanyo representative or agent.</li> <li>• Is there little gas remaining in the gas cylinder?</li> <li>• Is the secondary pressure for the CO<sub>2</sub> gas pressure regulator at the specified value of 0.03 MPaG (0.3 kgf/cm<sup>2</sup>G, 4.3 psiG)?</li> <li>• Is the secondary pressure for the N<sub>2</sub>/CO<sub>2</sub> gas pressure regulator at the specified value of 0.05 MPaG (0.5 kgf/cm<sup>2</sup>G, 7.1 psiG)?</li> <li>• Is the gas tube blocked?</li> </ul>
The gas is not being injected.	<ul style="list-style-type: none"> <li>• The control method for the Incubator is the ON-OFF method. Gas is intermittently injected as the gas concentration in the chamber approaches the set value. Injections may be stopped for periods of approximately 60 seconds, but that is not an error.</li> </ul>
The outer door does not open.	<p>MCO-19M(UVH), or when the optional MCO-HL is installed:</p> <ul style="list-style-type: none"> <li>• When the power is OFF, the electric lock is locked and the outer door does not open. Either turn ON the power or use the accessory unlock key to override the electric lock.</li> <li>• During decontamination the outer door is electrically locked and does not open.</li> </ul>
H <sub>2</sub> O <sub>2</sub> decontamination cannot be performed.	<ul style="list-style-type: none"> <li>• If the MCO-19M(UV)/19M is being used, is the optional MCO-HL installed?</li> <li>• If the MCO-19M is being used, are the optional MCO-HL and MCO-19UVS installed?</li> <li>• Is the UV lamp burned out? If the UV lamp is burned out, H<sub>2</sub>O<sub>2</sub> decontamination will not be possible.</li> <li>• Is the H<sub>2</sub>O<sub>2</sub> Generator cable properly connected?</li> <li>• Has the entire bottle of H<sub>2</sub>O<sub>2</sub> Decontamination Reagent been used?</li> <li>• Has the upper limit temperature alarm been set to 50°C or higher?</li> </ul>

**Note:** If the problem still has not been solved after trying the above checks and countermeasures, or for any problems not covered here, contact a Sanyo representative or agent.

# DISPOSING OF THE MULTI-GAS INCUBATOR

When disposing of the multi-gas incubator, contact a Sanyo sales representative or agent.



## **WARNING**

**The incubator must be dismantled and disposed of by qualified personnel only.** If the incubator is left where outsiders enter, it may result unexpected accident (for example, children to become locked inside).

Before disposing a multi-gas incubator with biohazardous danger, decontaminate the multi-gas incubator to the extent possible by the user.

**Note:**

**This symbol mark and recycle system apply only to EU countries. They do not applied to the countries in other areas of the world.**

**Waste Electrical and Electronic Equipment (WEEE) Directive 2002/96/EC**

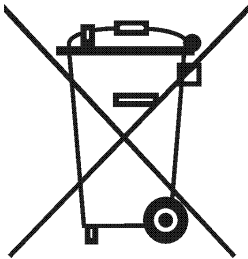

**(English)**

This SANYO product is designed and manufactured with high-quality materials and components that can be recycled and reused.

This symbol means that the electrical and electronic equipment, at their end-of-life, should be disposed of separately from household wastes.

Dispose of this product at your local community waste collection/recycling center.

In the European Union there are separate collection systems for used electrical and electronic products.

Please help us to conserve the environment we live in.

**(German)**

Ihr SANYO Produkt wurde entworfen und hergestellt mit qualitativ hochwertigen Materialien und Komponenten, die recycelt und wiederverwendet werden können.

Dieses Symbol bedeutet, daß elektrische und elektronische Geräte am Ende ihrer Nutzungsdauer von Hausmüll getrennt entsorgt werden sollen.

Bitte entsorgen Sie dieses Gerät bei Ihrer örtlichen kommunalen Sammelstelle oder im Recycling Centre.

In der Europäischen Union gibt es unterschiedliche Sammelsysteme für Elektrik- und Elektronikgeräte.

Helfen Sie uns bitte, die Umwelt zu erhalten, in der wir leben!



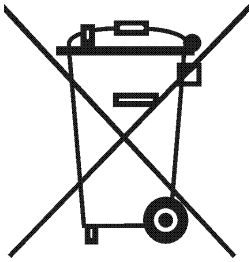

**(French)**

Votre produit Sanyo est conçu et fabriqué avec des matériaux et des composants de qualité supérieure qui peuvent être recyclés et réutilisés.

Ce symbole signifie que les équipements électriques et électroniques en fin de vie doivent être éliminés séparément des ordures ménagères.

Nous vous prions donc de confier cet équipement à votre centre local de collecte/recyclage. Dans l'Union Européenne, il existe des systèmes sélectifs de collecte pour les produits électriques et électroniques usagés.

Aidez-nous à conserver l'environnement dans lequel nous vivons !

Les machines ou appareils électriques et électroniques contiennent fréquemment des matières qui, si elles sont traitées ou éliminées de manière inappropriée, peuvent s'avérer potentiellement dangereuses pour la santé humaine et pour l'environnement.

Cependant, ces matières sont nécessaires au bon fonctionnement de votre appareil ou de votre machine. Pour cette raison, il vous est demandé de ne pas vous débarrasser de votre appareil ou machine usagé avec vos ordures ménagères.

**(Spanish)**

Los productos SANYO están diseñados y fabricados con materiales y componentes de alta calidad, que pueden ser reciclados y reutilizados.

Este símbolo significa que el equipo eléctrico y electrónico, al final de su ciclo de vida, no se debe desechar con el resto de residuos domésticos.

Por favor, deposite su viejo "televisor" en el punto de recogida de residuos o contacte con su administración local.

En la Unión Europea existen sistemas de recogida específicos para residuos de aparatos eléctricos y electrónicos.

Por favor, ayúdenos a conservar el medio ambiente!

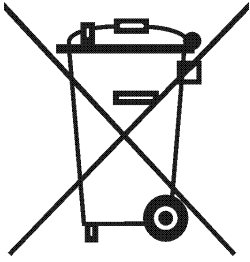

**(Portuguese)**

O seu produto SANYO foi concebido e produzido com materiais e componentes de alta qualidade que podem ser reciclados e reutilizados.

Este símbolo significa que o equipamento eléctrico e electrónico no final da sua vida útil deverá ser descartado separadamente do seu lixo doméstico.

Por favor, entregue este equipamento no seu ponto local de recolha/reciclagem.

Na União Europeia existem sistemas de recolha separados para produtos eléctricos e electrónicos usados.

Por favor, ajude-nos a conservar o ambiente em que vivemos!

**(Italian)**

Il vostro prodotto SANYO è stato costruito da materiali e componenti di alta qualità, che sono riutilizzabili o riciclabili.

Prodotti elettrici ed elettronici portando questo simbolo alla fine dell'uso devono essere smaltiti separatamente dai rifiuti casalinghi.

Vi preghiamo di smaltire questo apparecchio al deposito comunale.  
Nell'Unione Europea esistono sistemi di raccolta differenziata per prodotti elettrici ed elettronici.

Aiutateci a conservare l'ambiente in cui viviamo!

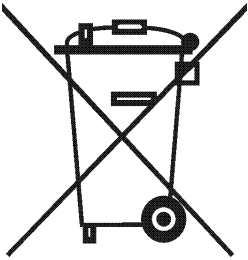

**(Dutch)**

Sanyo producten zijn ontwikkeld en gefabriceerd uit eerste kwaliteit materialen, de onderdelen kunnen worden gerecycled en weer worden gebruikt.

Het symbool betekent dat de elektrische en elektronische onderdelen wanneer deze vernietigd gaan worden, dit separaat gebeurt van het normale huisafval.

Zorg ervoor dat het verwijderen van de apparatuur bij de lokaal erkende instanties gaat gebeuren. In de Europese Unie wordt de gebruikte elektrische en elektronische apparatuur bij de daarvoor wettelijke instanties aangeboden.

Alstublieft help allen mee om het milieu te beschermen.

**(Swedish)**

Din SANYO produkt är designad och tillverkad av material och komponenter med hög kvalitet som kan återvinnas och återanvändas.

Denna symbol betyder att elektriska och elektroniska produkter, efter slutanvändande, skall sorteras och lämnas separat från Ditt hushållsavfall.

Vänligen, lämna denna produkt hos Din lokala mottagningstation för avfall/återvinningsstation.

Inom den Europeiska Unionen finns det separata återvinningssystem för begagnade elektriska och elektroniska produkter.

Vänligen, hjälp oss att bevara miljön vi lever i!

# AUTOMATIC CO<sub>2</sub> CYLINDER CHANGEOVER

An automatic CO<sub>2</sub> cylinder changeover system (MCO-21GC) is available as an optional accessory. This system switches the gas supply lines when one CO<sub>2</sub> gas cylinder becomes empty.

**Note:** The installation of the MCO-21GC must be performed only by qualified service personnel.

Install the MCO-21GC and then perform the following procedure

1. Connect 2 gas tubes to connecting ports A/B for CO<sub>2</sub> gas pipe. Connecting ports for CO<sub>2</sub> gas pipes are located on the left back of the Incubator. (Refer to page 9).

**Note:** Only port A can be used when the MCO-21GC is not installed. There will be 2 ports, ports A and B, after the MCO-21GC is installed.

2. Connect a CO<sub>2</sub> gas cylinder equipped with a gas pressure regulator to each gas tube. Refer to page 16 for information on connecting the gas cylinders. (“Gas cylinder A” is the CO<sub>2</sub> gas cylinder connected to the connecting port A for CO<sub>2</sub> gas pipe, and “gas cylinder B” is the CO<sub>2</sub> gas cylinder connected to the connecting port B for N<sub>2</sub>/O<sub>2</sub> gas pipe.)

3. Open the valves of both gas cylinders.

4. The current CO<sub>2</sub> gas supply line is displayed on the Top Display.

(“A” and “B” will be displayed only when the MCO-21GC is installed. Nothing will be displayed if MCO-21GC is not installed.)

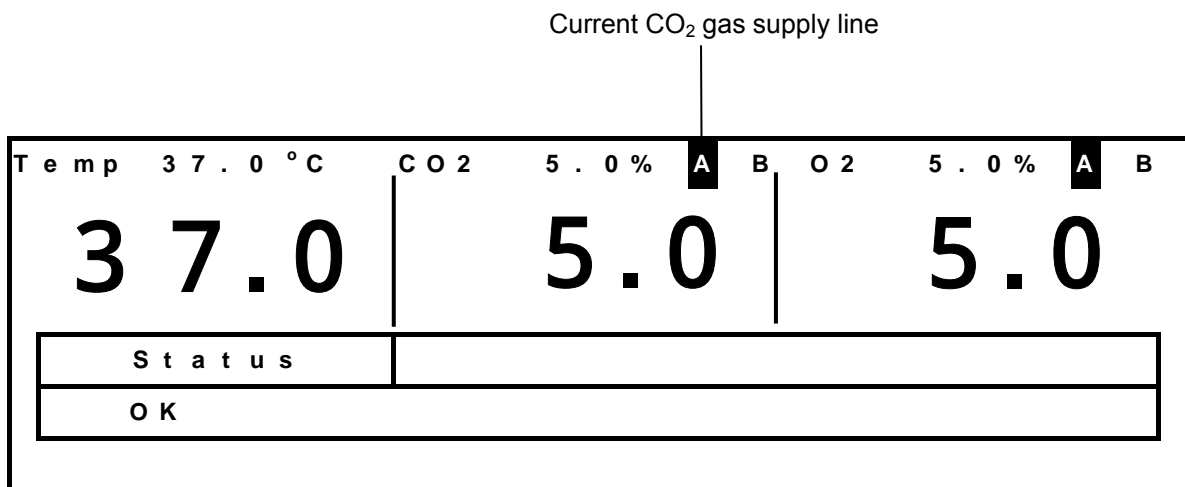

5. The MCO-21GC detects that there is no more CO<sub>2</sub> gas in a cylinder when the CO<sub>2</sub> density in the chamber does not increase for a while even after opening the CO<sub>2</sub> gas valve in the Incubator. It switches the gas supply line when it detects that there is no more gas. At that time, the following indications of switching the gas cylinder are provided.

	Message display field	Display of gas supply
When CO <sub>2</sub> gas supply line switches automatically (Only when MCO-21GC is installed)	Err01: CO <sub>2</sub> Gas Empty is displayed.	The character for gas supply line that is empty blinks. The gas supply line that is currently being used is displayed in reverse video.

To silence the buzzer, press the BUZZER Key. The alarm condition is cleared and normal operation continues.

6. When gas cylinder A is switched to B, remove gas cylinder A and replace it with new one.

**Note:** Be careful when handling the empty CO<sub>2</sub> gas cylinder. Some gas may still be left in the cylinder.

• When gas cylinder B becomes empty, the line is switched to gas cylinder A again.

The MCO-21GC detects that there is no more CO<sub>2</sub> gas in a cylinder when the CO<sub>2</sub> density in the chamber does not increase for a while even after opening the CO<sub>2</sub> gas valve in the Incubator. The supply line may also be switched for other reasons even though there is gas left in the cylinder: blocking or restricting of gas tube, reduction of CO<sub>2</sub> gas pressure, or improper opening of CO<sub>2</sub> gas cylinder. Always check the gas quantity in the cylinder before disconnecting it.

• Use the following procedure to manual switch the line between CO<sub>2</sub> cylinders A and B (only when MCO-21GC is installed). This procedure shows switching the line from CO<sub>2</sub> cylinder B to A as an example.

1. From the Top Display, press the Left Cursor Key for 3 seconds.

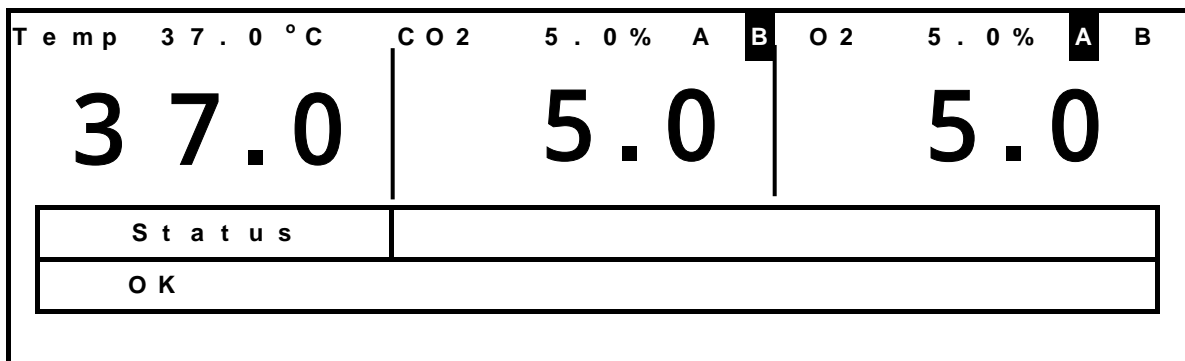

2. The CO<sub>2</sub> gas supply line will be switched from cylinder B to A

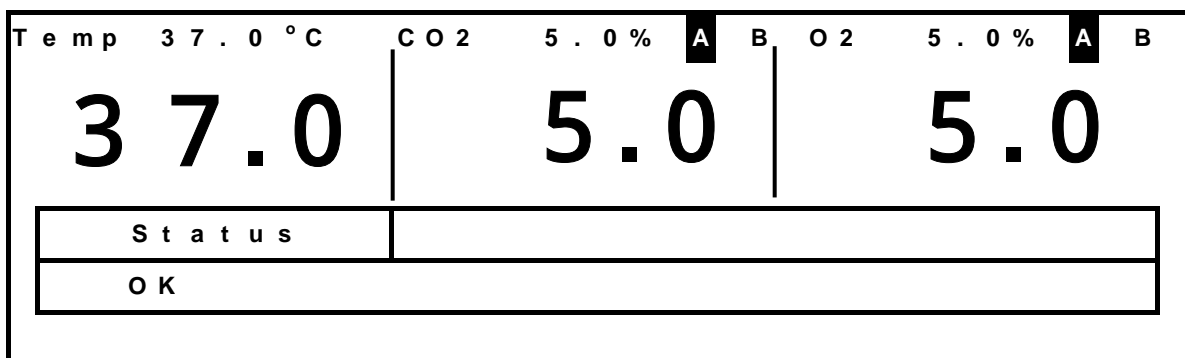

(When the line needs to be switched from cylinder A to B, press the Right Cursor Key for 3 seconds.)

# AUTOMATIC CO<sub>2</sub> AND O<sub>2</sub> DENSITY CALIBRATION

To calibrate the CO<sub>2</sub> and O<sub>2</sub> density, a Semi-automatic one point Gas Calibration Kit (MCO-SG) is available. By connecting a standard gas cylinder that has a density that is the same as the set CO<sub>2</sub> and O<sub>2</sub> density (usually 5% CO<sub>2</sub> and 5% O<sub>2</sub>), the CO<sub>2</sub> sensor and O<sub>2</sub> sensor can be calibrated to maintain the accuracy of the CO<sub>2</sub> and O<sub>2</sub> density display as necessary.

- Setting connected standard gas density

1. Press the MENU Key from the Top Display to display the menu, select **Tools**, and press the ENTER Key.

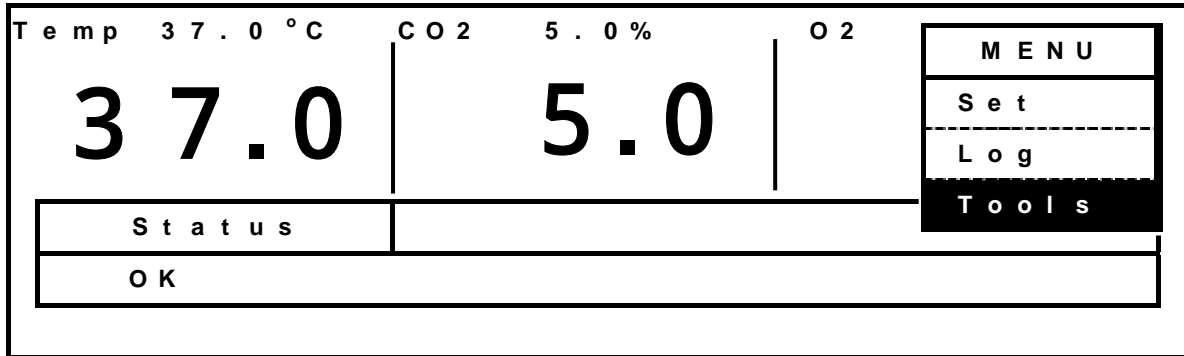

2. Press the Down Cursor Key from the Select Tools (1/2) Display to display the Select Tools (2/2) Display, and then select **Standard Gas Setting**, press the MENU Key to display the menu, select **OK**, and press the ENTER Key.

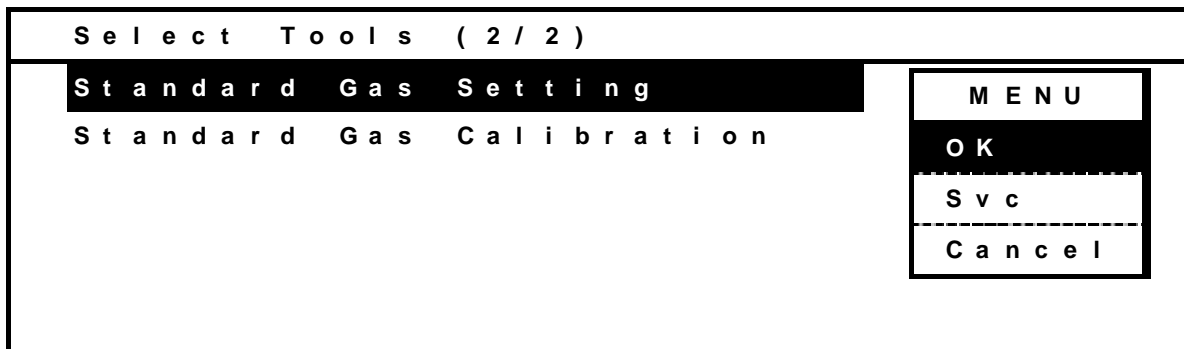
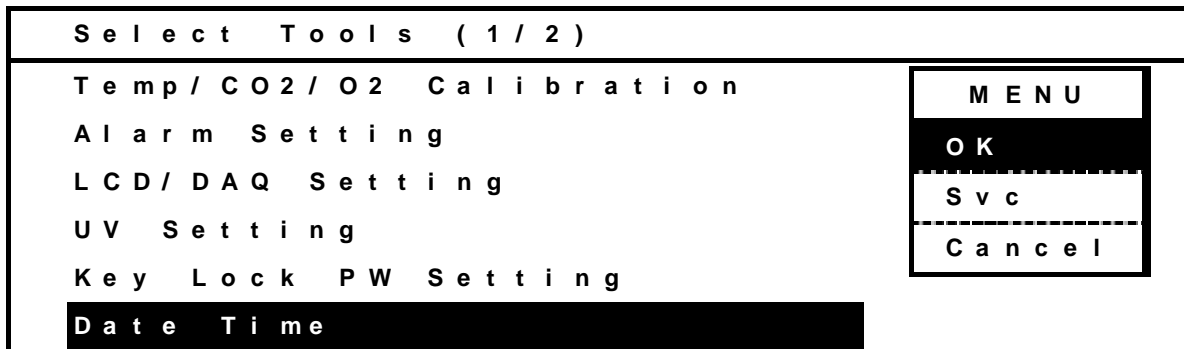

3. Input the CO<sub>2</sub> and O<sub>2</sub> density of standard gas to be used, press the MENU Key to display the menu, select **OK**, and press the ENTER Key.

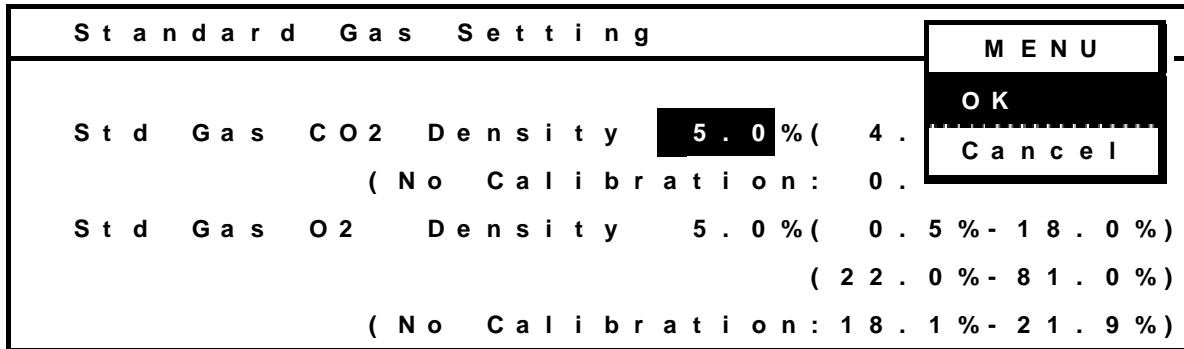

Ex. Standard gas density input

	Standard gas density (For example)	Input value of CO <sub>2</sub> density	Input value of O <sub>2</sub> density
Calibrate both of CO <sub>2</sub> and O <sub>2</sub> density	CO <sub>2</sub> :5% / O <sub>2</sub> :5%	050	050
Calibrate only CO <sub>2</sub> density	CO <sub>2</sub> :5% / O <sub>2</sub> :20%	050	200
Calibrate only O <sub>2</sub> density	CO <sub>2</sub> :0% / O <sub>2</sub> :5%	000	050

• Calibration method for CO<sub>2</sub> and O<sub>2</sub> gas density

1. Select **Standard Gas Calibration** from the Select Tools (2/2) Display, press the MENU Key to display the menu, select **OK**, and press the ENTER Key.

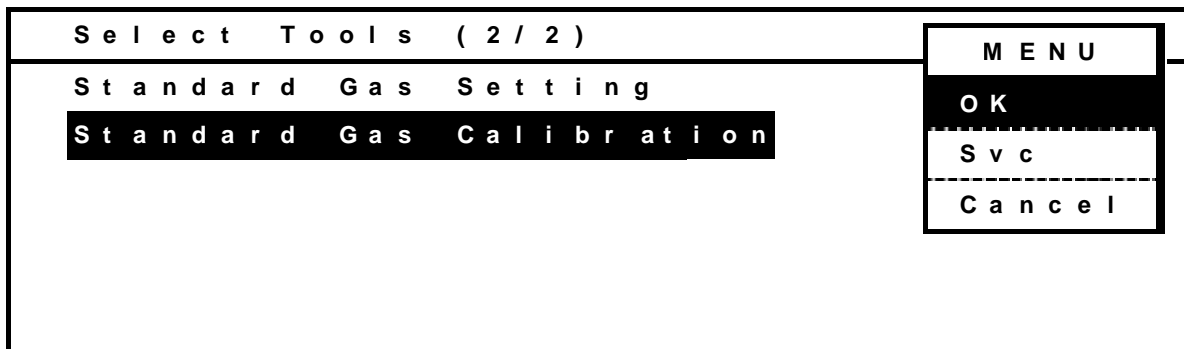

2. The system check will start.

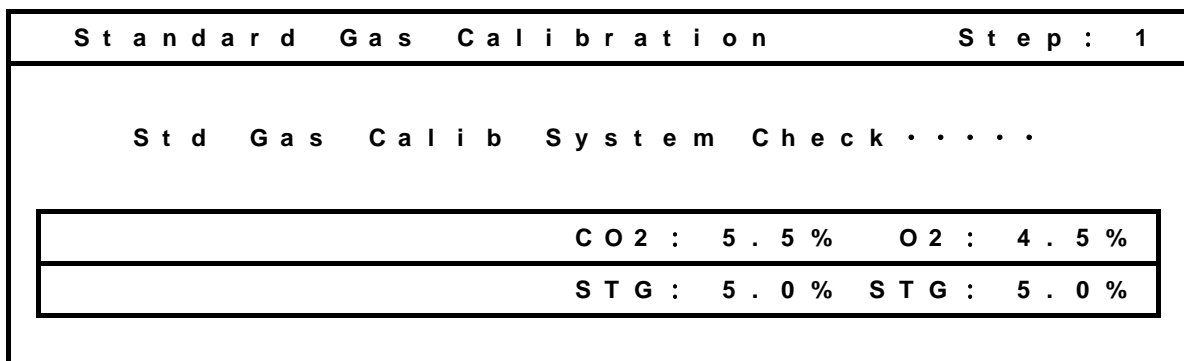

3. If the system is normal, the following display will appear. Select **OK** and press the ENTER Key to start calibrating the CO<sub>2</sub> and O<sub>2</sub> density. After calibration, return to normal cultivating operation.

Standard Gas Calibration		M E N U
Std Gas Calib Start ?		OK
		C a n c e l
CO <sub>2</sub> : 5 . 5 %		O <sub>2</sub> : 4 . 5 %
STG : 5 . 0 %		STG : 5 . 0 %



Standard Gas Calibration		Step : 3
Std Gas Calibrating . . . . .		
CO <sub>2</sub> : 5 . 5 %		O <sub>2</sub> : 4 . 5 %
STG : 5 . 0 %		STG : 5 . 0 %



Temp 37.0 °C	CO <sub>2</sub> 5.0% A B	O <sub>2</sub> 5.0% A B
<b>37.0</b>	<b>5.0</b>	<b>5.0</b>
Status		
OK		



# STACKING INCUBATORS

Use the following procedure to stack Incubators. This work is potentially dangerous, so contact a Sanyo representative or agent.

## CAUTION

- **Select a floor that is strong enough to support the stacked incubators.**
- **Never stack three or more incubators.** Doing so is dangerous.

1. Take out two stacking plates A, two stacking plates B, four protective stickers, and four screws from accessory bag.

### **Note:**

When stacking two incubators, **use two stacking plates (A and B) for each one.** Only one pair of stacking plates is provided per incubator, so take out the stacking plates (A and B) from both incubators. Similarly only 2 protective stickers are provided per incubator

2. Unplug both of the Incubators that are to be stacked.

3. Remove the caps at the two places in the front of the top surface of the Incubator that is to be on the bottom, attach the protective stickers to the four corners on the top surface of the Incubator that is to be on the bottom. (See Fig. A.)

4. Secure stacking plate A with the screws that are provided.

5. Remove the front panel (5 screws) from the Incubator that is to be on the top.

6. Place the upper Incubator on top of the lower one, being careful not to pinch your fingers.

7. Make the lower Incubator level by adjusting the legs, and then level the upper Incubator in the same way.

8. Secure the stacking plate A fixed to the lower incubator to the upper Incubator with the accessory screws.

9. Remove from the back of the lower Incubator the two hooks (4 screws) and remove from the upper Incubator the 2 screws on the lower rear panel.

10. Use the 6 screws that were removed in step 9 to secure stacking plate B to the rear panels of the upper and lower Incubators.

11. Replace the front panel (5 screws) to the upper Incubator.

12. Use the hooks on the back of the upper Incubator to prevent the Incubators from falling over.

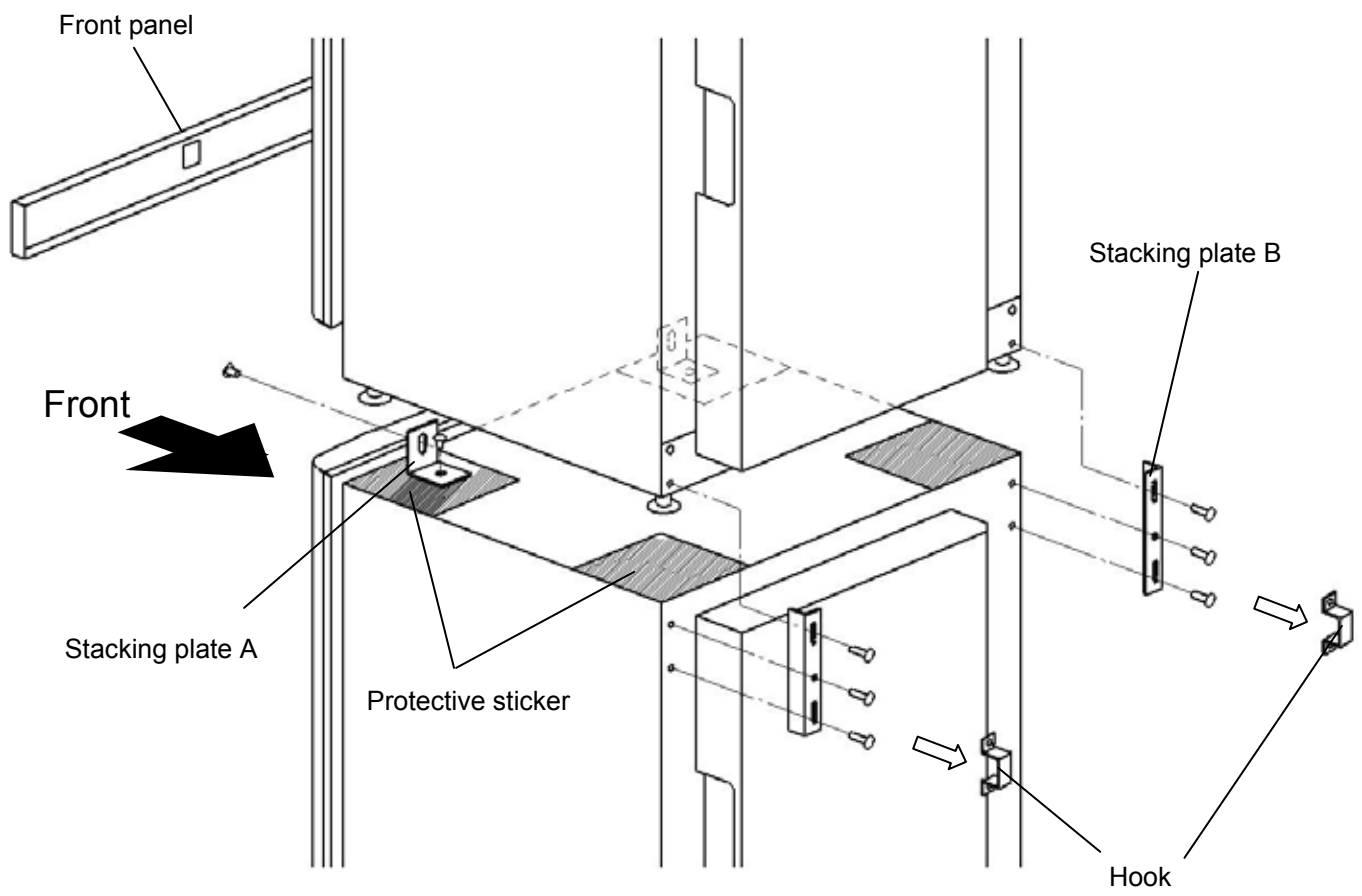

Fig.A

# SPECIFICATIONS

Name	Multi-gas Incubator		
Models	MCO-19M	MCO-19M(UV)	MCO-19M(UVH)
External dimensions	W620 x D710 x H900 mm (W24.4 x D28.0 x H35.4 inch)		
Internal dimensions	W490 x D523 x H665 mm (W19.3 x D20.6 x H26.2 inch)		
Interior volume	162 L (5.72 cu.ft.)		
Exterior	Painted steel		
Interior	Stainless steel containing copper		
Outer door	Painted steel		
Inner door	Stainless steel with gasket		
Gastight split door	4 doors made of tempered glass		
Trays	3 trays made of stainless steel containing copper W450 x D450 x H12 mm (W17.7 x D17.7 x H0.47 inch), Maximum load: 7 kg/tray		
Access port	Inner diameter: 30 mm (1.18 inch), On the back side		
Insulation	Rigid polyurethane foamed-in place		
Heating system	DHA system (heater jacket + air jacket system)		
Heater	314 W		
Humidifying system	Natural evaporation with humidifying pan		
Temperature controller	PID control system		
Temperature display	Digital display		
CO <sub>2</sub> controller	PID control system		
CO <sub>2</sub> density display	Digital display		
O <sub>2</sub> controller	PID control system		
O <sub>2</sub> density display	Digital display		
Air circulation	Fan assisted		
Air filter	0.3 μm, Efficiency: 99.97% or higher		
UV lamp	-----	4W X 1 (ozone-free emission)	
Water level sensor	Optical		
Alarms	Automatic set temperature alarm, Automatic set CO <sub>2</sub> density alarm Automatic set O <sub>2</sub> density alarm, Upper limit temperature alarm various gas/sensor/heater alarms		
Remote alarm contacts	Allowable contact capacity: 30 VDC, 2 A		
CO <sub>2</sub> inlet connection	4 to 6 mm (0.157 to 0.236 inch) diameter tube can be connected		
CO <sub>2</sub> inlet pressure	0.03 MPaG (0.3 kgf/cm <sup>2</sup> G, 4.3 psiG)		
O <sub>2</sub> inlet connection	4 to 6 mm diameter tube can be connected		
O <sub>2</sub> inlet pressure	0.05 MPaG (0.5 kgf/cm <sup>2</sup> G, 7.1 psiG)		
Weight	94 kg		

Name	Multi-gas Incubator		
Models	MCO-19M	MCO-19M(UV)	MCO-19M(UVH)
Accessories	3 trays, 3 sets of tray supports, 3 gas tubes, 1 humidifying pan, 1 gas injection nozzle, 1 gas injection nozzle tube 1 pair of stacking plates A and B, 2 protective stickers, 6 tube bands		
Optional accessories	H <sub>2</sub> O <sub>2</sub> Generator (MCO-HP) H <sub>2</sub> O <sub>2</sub> Decontamination Kit (MCO-HL)		Standard equipment
	UV Lamp Add-on Kit (MCO-19UVS)	Standard equipment	
	H <sub>2</sub> O <sub>2</sub> Decontamination Reagent (MCO-H2O2), Automatic CO <sub>2</sub> Standard Gas Calibration Kit (MCO-SG), Gas Pressure Regulator (MCO-100L), Extra Trays (MCO-47ST, includes 2 tray supports), Half Trays (MCO-25ST), Automatic CO <sub>2</sub> Cylinder Changeover System (MCO-21GC), Roller Base (MCO-18RB), UV lamp replacement kit (MCO-20UV) Stacking spacer (MCO-18SB, when stacking on the MCO-175), Stacking spacer (MCO-21SB, when stacking on the MCO-20AIC) Ethernet (LAN) Interface (MTR-L03), RS232C/RS485 Interface (MTR-480) SANYO Data acquisition software (MTR-5000) 4-20mA Interface (MCO-420MA, USA only)		

**Note:** Designs and specifications are subject to change without notice.

## PERFORMANCE

Temperature control range	Ambient temperature+5 to 50°C (ambient temperature: 5 to 35°C)		
Temperature distribution	± 0.25°C (ambient temperature: 25°C, setting: 37°C, CO <sub>2</sub> : 5%, O <sub>2</sub> : 5%, no load)		
Temperature variation	± 0.1°C (ambient temperature: 25°C, setting: 37°C, CO <sub>2</sub> : 5%, O <sub>2</sub> : 5%, no load)		
CO <sub>2</sub> control range	0 to 20%		
CO <sub>2</sub> variation	± 0.15% (ambient temperature: 25°C, setting: 37°C, CO <sub>2</sub> : 5%, O <sub>2</sub> : 5%, no load)		
O <sub>2</sub> control range	1 to 18% and 22 to 80%		
O <sub>2</sub> variation	± 0.2% (ambient temperature: 25°C, setting: 37°C, CO <sub>2</sub> : 5%, O <sub>2</sub> : 5%, no load)		
Chamber humidity	95% ± 5%		
Applicable environment condition	Temperature: 5 to 35°C, Humidity: 80% max. (The designed performance may not be obtained if the ambient temperature is equal or less than 15°C)		
Noise level	30 dB (A scale)		
Power consumption	Max. 354 W	Max. 335 W	
Heat emission	Max. 1,274 kJ/h	Max. 1,206 kJ/h	
Rated voltage, frequency	110 to 120 V, 60 Hz	220 V, 60 Hz	220 to 240 V, 50 Hz
Amperage	Max. 3.1 A	Max. 1.5 A	Max. 1.5 A

**Note:** The unit with CE mark complies with EC directives.

Based on our measuring method.

Designs and specifications are subject to change without notice.

**⚠ CAUTION**

**Please fill in this form before servicing.  
Hand over this form to the service engineer to keep for his and your safety.**

## Safety check sheet

1. Unit contents

Risk of infection:	Yes	No
Risk of toxicity:	Yes	No
Risk from radioactive sources:	Yes	No

(List all potentially hazardous materials that have been stored in this unit.)

Notes :

2. Contamination of the unit

Unit interior

No contamination	Yes	No
Decontaminated	Yes	No
Contaminated	Yes	No
Others:		

3. Instructions for safe repair/maintenance of the unit

a) The unit is safe to work on	Yes	No
b) There is some danger (see below)	Yes	No

Procedure to be adhered to in order to reduce safety risk indicated in b) below.

Date :

Signature :

Address, Division :

Telephone :

Product name : Multi-gas incubator	Model : MCO-19M(UVH) MCO-19M(UV) MCO-19M	Serial number :	Date of Installation :
---------------------------------------	---	-----------------	------------------------

Please decontaminate the unit yourself before calling the service engineer.

7FB6P101569000  
(26 August 2010)



**SANYO Electric Co., Ltd.**  
5-5, Keihan-Hondori 2-Chome  
Moriguchi City, Osaka 570-8677 Japan  
Printed in Japan

## Free Manuals Download Website

<http://myh66.com>

<http://usermanuals.us>

<http://www.somanuals.com>

<http://www.4manuals.cc>

<http://www.manual-lib.com>

<http://www.404manual.com>

<http://www.luxmanual.com>

<http://aubethermostatmanual.com>

Golf course search by state

<http://golfingnear.com>

Email search by domain

<http://emailbydomain.com>

Auto manuals search

<http://auto.somanuals.com>

TV manuals search

<http://tv.somanuals.com>