

SERVICE MANUAL (Expanded Information)



KS1822



**C1822
CL1822**

SPLIT SYSTEM AIR CONDITIONER

Indoor Unit

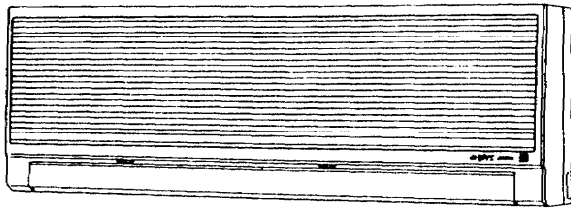

KS1822



Outdoor Unit

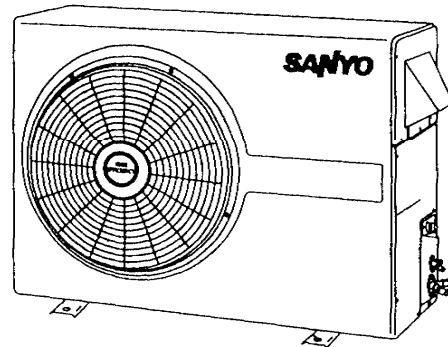

C1822 / CL1822



SERVICE MANUAL

KS1822 — C1822
CL1822

(Expanded Information)

IMPORTANT! Please Read Before Starting

This air conditioning system meets strict safety and operating standards. As the installer or service person, it is an important part of your job to install or service the system so it operates safely and efficiently.

For safe installation and trouble-free operation, you must:

- Carefully read this instruction booklet before beginning
- Follow each installation or repair step exactly as shown
- Observe all local, state, and national electrical codes
- Pay close attention to all warning and caution notices given in this manual



WARNING:

This symbol refers to a hazard or unsafe practice which can result in severe personal injury or death.



CAUTION:

This symbol refers to a hazard or unsafe practice which can result in personal injury or product or property damage.

If Necessary, Get Help

These instructions are all you need for most installation sites and maintenance conditions. If you require help for a special problem, contact our sales/service outlet or your certified dealer for additional instructions.

In Case of Improper Installation

The manufacturer shall in no way be responsible for improper installation or maintenance service, including failure to follow the instructions in this document.

SPECIAL PRECAUTIONS

When Wiring

ELECTRICAL SHOCK CAN CAUSE SEVERE PERSONAL INJURY OR DEATH. ONLY A QUALIFIED, EXPERIENCED ELECTRICIAN SHOULD ATTEMPT TO WIRE THIS SYSTEM.

- Do not supply power to the unit until all wiring and tubing are completed or reconnected and checked.
- Highly dangerous electrical voltages are used in this system. Carefully refer to the wiring diagram and these instructions when wiring. Improper connections and inadequate grounding can cause **accidental injury or death**.
- **Ground the unit** following local electrical codes.
- Connect all wiring tightly. Loose wiring may cause overheating at connection points and a possible fire hazard.

When Transporting

Be careful when picking up and moving the indoor and outdoor units. Get a partner to help, and bend your knees when lifting to reduce strain on your back. Sharp edges or thin aluminum fins on the air conditioner can cut your fingers.

When Installing...

...In a Ceiling or Wall

Make sure the ceiling/wall is strong enough to hold the unit's weight. It may be necessary to construct a strong wood or metal frame to provide added support.

...In a Room

Properly insulate any tubing run inside a room to prevent "sweating" that can cause dripping and water damage to walls and floors.

...In Moist or Uneven Locations

Use a raised concrete pad or concrete blocks to provide a solid, level foundation for the outdoor unit. This prevents water damage and abnormal vibration.

...In an Area with High Winds

Securely anchor the outdoor unit down with bolts and a metal frame. Provide a suitable air baffle.

...In a Snowy Area (for Heat Pump-type Systems)

Install the outdoor unit on a raised platform that is higher than drifting snow. Provide snow vents.

When Connecting Refrigerant Tubing

- Keep all tubing runs as short as possible.
- Use the flare method for connecting tubing.
- Apply refrigerant lubricant to the matching surfaces of the flare and union tubes before connecting them, then tighten the nut with a torque wrench for a leak-free connection.
- Check carefully for leaks before starting the test run.

NOTE:

Depending on the system type, liquid and gas lines may be either narrow or wide. Therefore, to avoid confusion the refrigerant tubing for your particular model is specified as either "narrow" or "wide" rather than as "liquid" or "gas."

When Servicing

- Turn the power OFF at the main power box (mains) before opening the unit to check or repair electrical parts and wiring.
- Keep your fingers and clothing away from any moving parts.
- Clean up the site after you finish, remembering to check that no metal scraps or bits of wiring have been left inside the unit being serviced.

Table of Contents

	Page
1. SPECIFICATIONS	
1-1 Unit Specifications	1
1-2 Major Component Specifications	2
(1) Indoor and Outdoor Units	2
(a) KS1822 (Indoor unit)	
(b) C1822 (Outdoor unit)	
(c) CL1822 (Outdoor unit)	
1-3 Other Component Specifications.....	5
(1) Indoor Unit	5
(2) Outdoor Unit.....	6
2. PERFORMANCE CHARTS	
2-1 Operating Current	7
2-2 Low Pressure	8
3. AIR THROW DISTANCE CHART	9
4. FUNCTION	
4-1 Room Temperature Control	10
4-2 Freeze Prevention	11
4-3 Fan Speed Auto (Indoor Fan)	11
4-4 Outdoor Fan Speed Control (C1822).....	12
4-5 Outdoor Fan Speed Control (CL1822).....	12
5. ELECTRICAL DATA	
● Schematic Diagram.....	13
● Electric Wiring Diagram (PCB Ass'y)	15
6. TROUBLESHOOTING	
6-1 Check before and after troubleshooting.....	19
(1) Check power supply wiring.....	19
(2) Check inter-unit wiring.....	19
(3) Check power supply	19
(4) Check lead wires and connectors in indoor and outdoor units	19
(5) Reference	20
(a) Condition of general cooling operation	
(b) Condition of cooling operation under low ambient temperature	

6-2	Air conditioner does not operate	22
	(1) Circuit breaker trips (or fuse blows).....	22
	(a) When circuit breaker is set to ON, it trips in a few moments	
	(b) Circuit breaker trips several minutes after turning air conditioner ON	
	(2) Neither indoor unit nor outdoor unit runs.....	24
	(a) Power is not supplied	
	(b) Check remote control unit	
	(c) Check OPERATION selector switch in indoor unit	
	(d) Check fuse in indoor unit	
	(e) Check transformer in indoor unit	
	(f) Check fuse on PCB Ass'y in indoor unit	
	(3) Only outdoor unit does not run.....	27
	(a) Check COOL/FAN selector switch of remote control unit	
	(b) Outdoor unit does not run when air conditioner is in following conditions	
	(c) Check relay (RY) in indoor unit	
	(d) Check electro-magnetic contactor (CL1822 only)	
6-3	A particular component of air conditioner does not operate	29
	(1) Only indoor fan does not run	29
	(2) Only outdoor fan does not run.....	29
	(3) Only outdoor fan does not run for CL1822	30
	(4) Only compressor does not run	30
6-4	Air conditioner operates, but abnormalities occur.....	31
	(1) Poor Cooling.....	31
	(2) Excessive Cooling	32
6-5	Indoor (heat exchanger) coil temperature sensor (TH1) is defective	32
	(1) Open.....	32
	(2) Shortage	32

7. CHECKING ELECTRICAL COMPONENTS

7-1	Measurement of Insulation Resistance	33
	(1) Power Supply Wires	33
	(2) Indoor Unit	33
	(3) Outdoor Unit.....	33
	(4) Measurement of Insulation Resistance for Electrical Parts	33
7-2	Checking Continuity of Fuse on PCB Ass'y.....	34
7-3	Checking Motor Capacitor	34
7-4	Appearance of Electrical Parts	35
	(1) Relay	35
	(2) Thermostat	35
	(3) Electro-Magnetic Contactor.....	35
	(4) Relay	35
	(5) SSR (solid state relay)	36

1. SPECIFICATIONS

1-1 Unit Specifications

Model No.		Indoor Unit	KS1822
		Outdoor Unit	C1822 / CL1822
Performance			Cooling
	Capacity	BTU/h	17,000 / 16,500
		kW	4.98 / 4.84
	Air circulation (High)	cu. ft./min.	440 / 420
Moisture removal (High)	pints/h	5.3 / 5.2	
Electrical Rating	Phase, Frequency		Hz
	Voltage rating		V
	Available voltage range		V
	Running amperes		A
	Power input		W
	Power factor		%
	Starting amperes		A
	S. E. E. R.		BTU/Wh
Features	Controls		Microprocessor
	Control unit		Wireless remote control unit
	Temperature control		IC thermostat
	Timer		ON/OFF, 24-hours & Program
	Fan speeds		Indoor / Outdoor
	Air deflector		Horizontal / Vertical
	Air filter		Washable, easy access
	Compressor		Rotary
	Refrigerant amount charged at shipment		lbs. (kg)
	Refrigerant control		Capillary tube
	Refrigerant tubing connections		Flare type
	Operation sound	In-Hi/Me/Lo	dB-A
		Out-Hi	dB-A
	Max. allowable tubing length at shipment		ft. (m)
	Limit of tubing length		ft. (m)
	Limit of elevation difference between the 2 units		ft. (m)
	Refrigerant tube o.d.	Narrow tube	in. (mm)
		Wide tube	in. (mm)
	Refrigerant tube kit		Optional
Accessories		Hanging wall bracket	
Dimensions & Weight			Indoor unit
			Outdoor unit
	Height	in. (mm)	14-3/16 (360)
	Width	in. (mm)	38-31/32 (990)
	Depth	in. (mm)	7-25/32 (198)
	Net weight	lbs. (kg)	30 (13.5)
Shipping volume	cu. ft. (cu. m)	4.8 (0.136)	
Shipping weight	lbs. (kg)	37.4 (17)	

DATA SUBJECT TO CHANGE WITHOUT NOTICE.

Remarks: Rating conditions are: Outside air temperature 95°F DB/75°F WB
Indoor unit entering air temperature 80°F DB/67°F WB

1-2 Major Component Specifications

(1) Indoor and Outdoor Units

(a) KS1822 (Indoor unit)

Unit Model No.				KS1822				
Remote Control Unit				RCS-KS2412W				
Controller PCB				POW-KS1812B				
	Control circuit fuse			250V, 3A				
Fan	Type			Cross-flow				
	Number ... Dia. and length			in. (mm) 1 ... O.D. 4 (100), L 29-9/32 (755)				
Fan Motor	Model ... Number			UF4T-31A6P ... 1				
	No. of pole ... rpm (230V, High)			4 ... 1,590				
	Nominal output			W(H.P.) 30 (1/25)				
	Coil resistance (Ambient temp. 68°F)			Ω				
				WHT - BRN: 102.6				
				WHT - VLT: 37.1				
				VLT - YEL: 30.9				
				YEL - PNK: 69.3				
	Safety devices	Type		Internal				
		Operating temp.	Open	°F	248 ± 9			
Close			°F	171 ± 27				
Run capacitor		μF	1.5					
		VAC	440					
Louver Motor	Model			M2EA24ZA01				
	Rating			208 to 230V, 60Hz				
	No. of pole ... rpm.			8 ... 3				
	Output			W 2.5				
	Coil resistance (at 68°F)			kΩ 16.45 ± 15%				
Heat Exch.	Coil			Aluminum plate fin / Copper tube				
	Rows ... Fins per inch			2 ... 14.1				
	Face area			ft. ² (m ²) 2.08 (0.19)				

DATA SUBJECT TO CHANGE WITHOUT NOTICE.

(b) C1822 (Outdoor unit)

Unit Model No.			C1822			
Fuse			AC 250V, 3A			
Compressor	Type		Rotary (hermetic)			
	Model ... Number		C-2R130H6P ... 1			
	No. of cyl. ... rpm		1 ... 3,500			
	Nominal output		W (H.P.)	1,300 (1-3/4)		
	Compressor lubricant		cc	800		
	Coil resistance (Ambient temp. 77°F)		Ω	C - R: 1.19 C - S: 2.47		
	Safety devices	Type		Internal	External	
		Overload relay models		—	—	
		Operating temp.	Open	°F	311 ± 9	—
			Close	°F	188 ± 20	—
Operating amp. (Ambient temp. 77°F)			—	—		
Run capacitor		μF	30			
		VAC	400			
Crank case heater			—			
Fan	Type		Propeller			
	Number ... Dia.		in. (mm)	1 ... 15-3/4 (400)		
Fan Motor	Model		SFG6S-61B6P			
	No. of pole ... rpm (230V, High)		6 ... 1,030			
	Nominal output		W (H.P.)	60 (1/12)		
	Coil resistance (Ambient temp. 68°F)		Ω	WHT - BRN: 88.2 WHT - YEL: 116.3 WHT - PNK: 116.4		
	Safety devices	Type		Internal		
		Operating temp.	Open	°F	266 ± 14	
			Close	°F	174 ± 27	
	Run capacitor		μF	2.5		
		VAC	440			
Heat Exch.	Coil		Aluminum plate fin / Copper tube			
	Rows ... fins per inch		2 ... 15.9			
	Face area		ft. ² (m ²)	5.57 (0.51)		
External Finish			Acrylic baked-on enamel finish			

DATA SUBJECT TO CHANGE WITHOUT NOTICE.

(c) CL1822 (Outdoor unit)

Unit Model No.				CL1822		
Controller PC3				POW-183CL		
	Control circuit fuse			AC 250V, 5A		
Compressor	Type			Rotary (hermetic)		
	Model ... Number			C-2R130H6P ... 1		
	No. of cyl. ... rpm			1 ... 3,500		
	Nominal output			W (H.P.)	1,300 (1-3/4)	
	Compressor lubricant			cc	800	
	Coil resistance (Ambient temp. 77°F)			Ω	C - R: 1.19 C - S: 2.47	
	Safety devices	Type		Internal		External
		Overload relay models		—		—
		Operating temp.	Open	°F	311 ± 9	—
			Close	°F	188 ± 20	—
	Operating amp. (Ambient temp. 77°F)		—		—	
Run capacitor		μF	30			
		VAC	400			
Crank case heater			230V, 30W			
Fan	Type			Propeller		
	Number ... Dia.			in. (mm)	1 ... 15-3/4 (400)	
Fan Motor	Model			SFG6S-61B6P		
	No. of pole ... rpm (230V, High)			6 ... 1,030		
	Nominal output			W (H.P.)	60 (1/12)	
	Coil resistance (Ambient temp. 68°F)			Ω	WHT - BRN: 88.2 WHT - YEL: 116.3 WHT - PNK: 116.4	
	Safety devices	Type		Internal		
		Operating temp.	Open	°F	266 ± 14	
			Close	°F	174 ± 27	
Run capacitor		μF	2.5			
		VAC	440			
Heat Exch.	Coil			Aluminum plate fin / Copper tube		
	Rows ... fins per inch			2 ... 15.9		
	Face area			ft. ² (m ²)	5.57 (0.51)	
External Finish				Acrylic baked-on enamel finish		

DATA SUBJECT TO CHANGE WITHOUT NOTICE.

1-3 Other Component Specifications

(1) Indoor Unit

Transformer		ATR-H122U
Rated	Primary	AC 220V, 60Hz
	Secondary	10V, 1.2A
	Capacity	12VA
Coil resistance	Ω (at 77°F)	Primary (WHT – WHT): $146 \pm 15\%$ Secondary (BRN – BRN): $0.5 \pm 15\%$
Thermal cut-off temp.		259°F, 2A 250V

Relay		DFU12D1-F(M)
Coil rating		DC 12V
Coil resistance	Ω (at 68°F)	$160 \pm 10\%$
Contact rating		AC 250V, 20A

Thermistor (coil sensor)		PBC-41E-S4			
Resistance	$k\Omega$	14°F	$23.7 \pm 5\%$	77°F	$5.3 \pm 5\%$
		32°F	$15.0 \pm 5\%$	86°F	$4.4 \pm 5\%$
		50°F	$9.7 \pm 5\%$	104°F	$3.1 \pm 5\%$
		68°F	$6.5 \pm 5\%$		

Thermistor (room sensor)		SDT-500B6-2			
Resistance	$k\Omega$	50°F	$10.3 \pm 4\%$	86°F	$4.0 \pm 4\%$
		59°F	$8.0 \pm 4\%$	104°F	$2.6 \pm 4\%$
		68°F	$6.3 \pm 4\%$	122°F	$1.8 \pm 4\%$
		77°F	$5.0 \pm 4\%$		

(2) Outdoor Unit

CL1822

Thermostat		MQT5S 27YZ	
Operating temp.	°F	ON	80 + 0, -5
		OFF	74 + 0, -5

CL1822

Transformer		ATR-J122U	
Rated	Primary	AC 220V, 60Hz	
	Secondary	19V, 0.63A	
	Capacity	12VA	
Coil resistance	Ω (at 77°F)	Primary (WHT - WHT): 147 ± 10%	
		Secondary (BRN - BRN): 1.3 ± 10%	
Thermal cut-off temp.		259°F, 2A 250V	

CL1822

Electro-Magnetic Contactor		CLK-16E3-21	
Coil rating		AC 240V, 60Hz	
Coil resistance	kΩ (at 77°F)	2.5 ± 15%	
Contact rating	(Main)	AC 240V, 18A	
	(Auxiliary)	AC 240V, 3A	

CL1822

Relay		MY2F-T1-USTS	
Coil rating		DC 24V	
Coil resistance	Ω (at 77°F)	650 ± 15%	
Contact rating		AC 240V, 5A	

CL1822

Thermistor (Air and coil sensor)		PBC-41E-S8, PBC-41E-S15			
Resistance	kΩ	14°F	23.7 ± 5%	77°F	5.3 ± 5%
		32°F	15.0 ± 5%	86°F	4.4 ± 5%
		50°F	9.7 ± 5%	104°F	3.1 ± 5%
		68°F	6.5 ± 5%		

CL1822

SSR (solid state relay)		G3L-205TL-TS1	
Input	Rating voltage	DC 12V	
	Control voltage range	DC 0 to 6.4V	
Load voltage range		AC 75 to 264V, 60Hz	

2. PERFORMANCE CHARTS

2-1 Operating Current

Operating current characteristics versus outdoor ambient temperature and indoor temperature
(Indoor relative humidity: 50%, Indoor fan speed: High)

230V

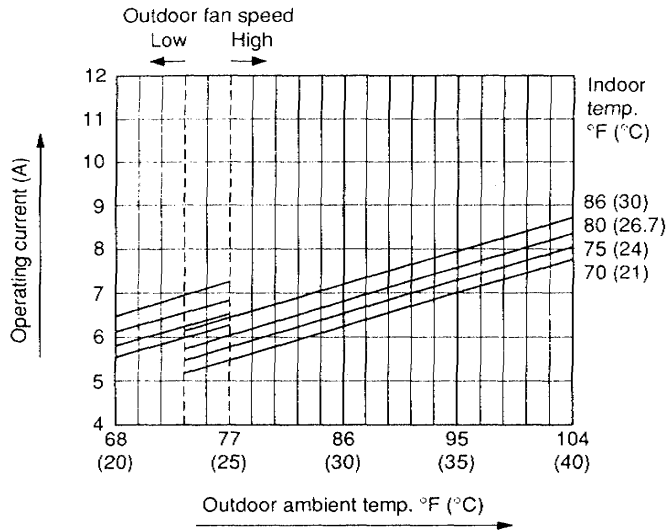

208V

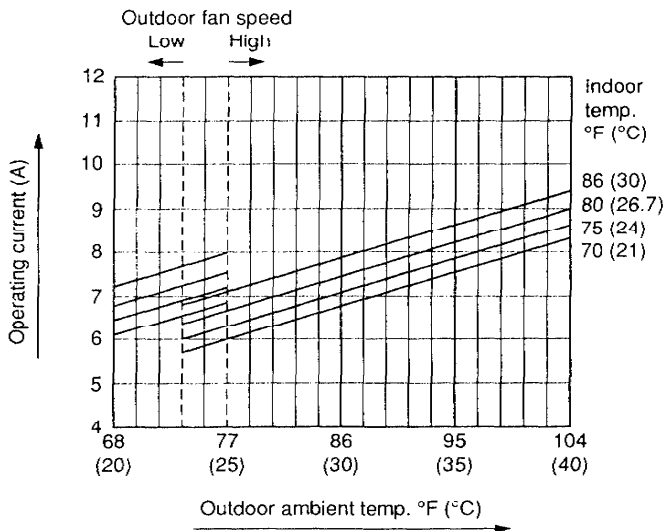

2-2 Low Pressure

■ KS1822 / C1822

● Low Pressure

Low pressure characteristics versus outdoor ambient temperature and indoor temperature
(Indoor relative humidity: 50%, Indoor fan speed: High)

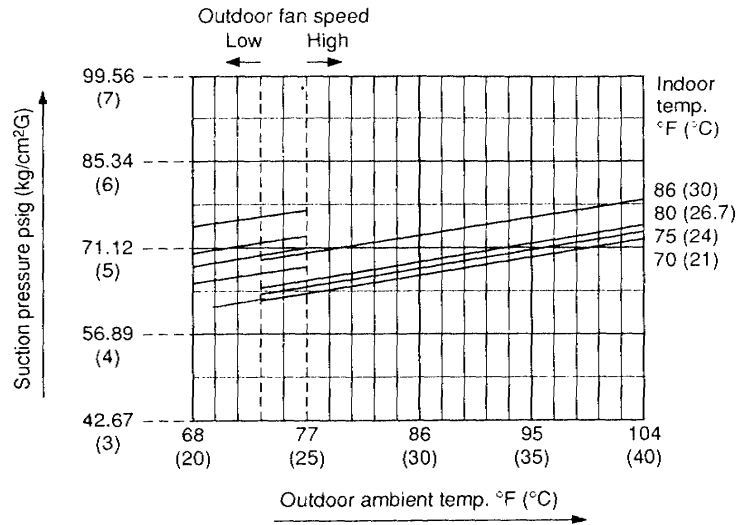

● Low Pressure

Low pressure characteristics versus outdoor ambient temperature and indoor temperature
(Indoor relative humidity: 50%, Indoor fan speed: High)

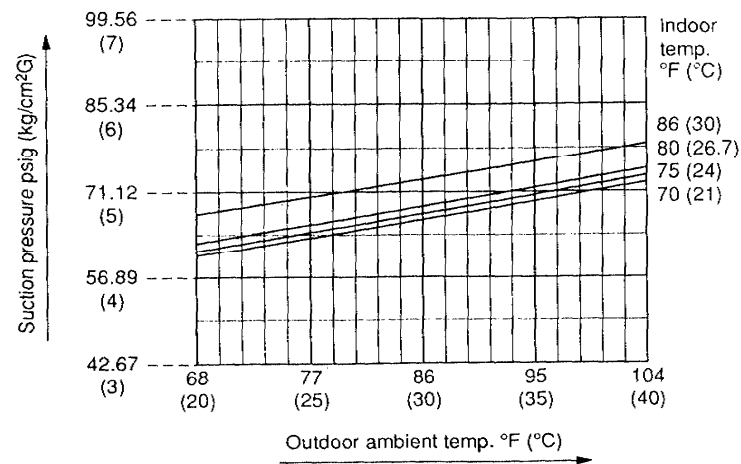

3. AIR THROW DISTANCE CHART

Model: KS1822

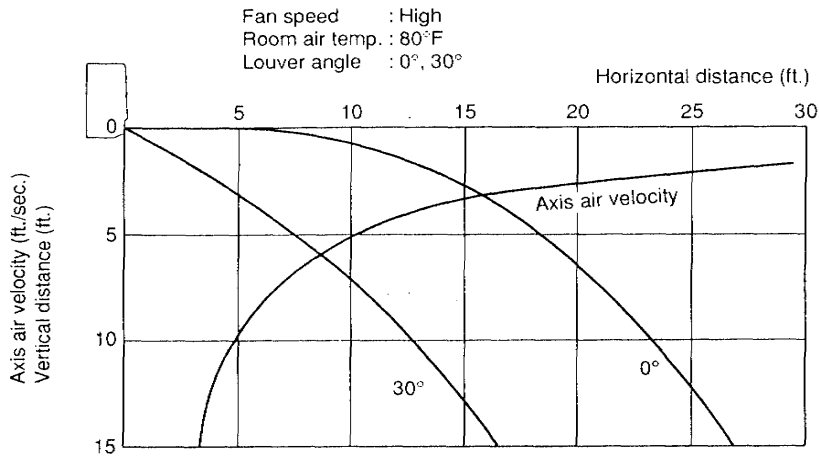

4-2 Freeze Prevention

- This function prevents freezing of the indoor heat exchange coil.
- When the compressor has been running for 10 minutes or more and the temperature of the indoor heat exchange coil falls below 27°F, the control circuit stops the compressor for at least 6 minutes.

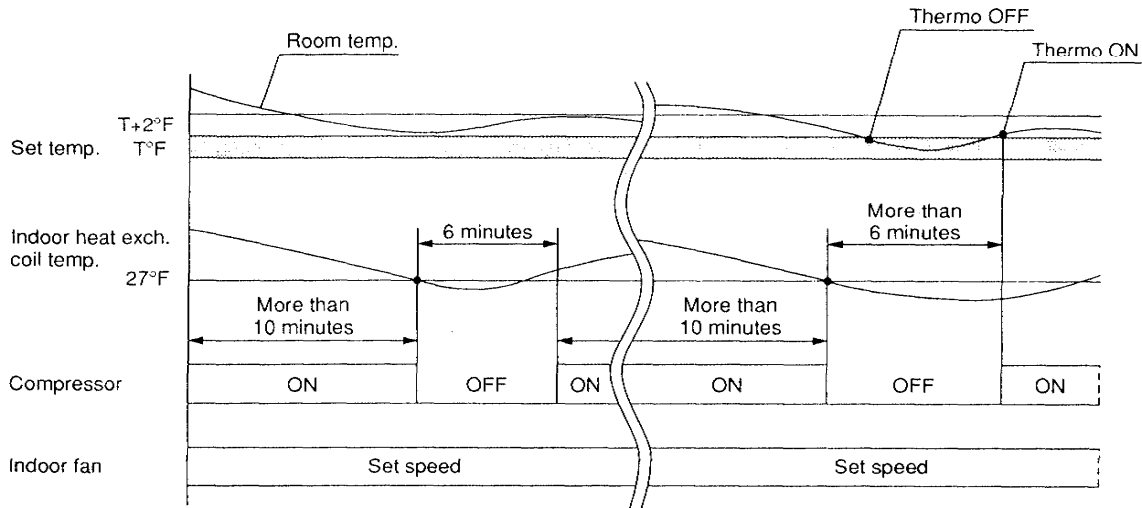

4-3 Fan Speed Auto (Indoor Fan)

- The fan speed does not change within 1 minute.
- The number shows temperature for REMOCON sensor.

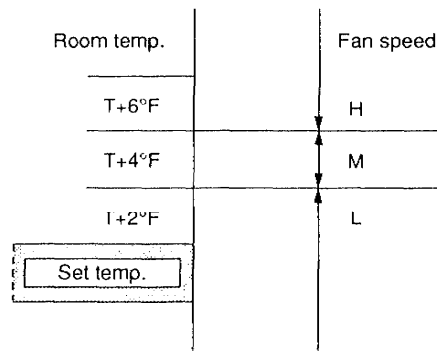

4-4 Outdoor Fan Speed Control (C1822)

- In low temperature areas, the outdoor fan goes automatically to LOW to prevent freezing.
- When the outdoor air temperature falls below 74°F, the outdoor fan is set to LOW.
- When the outdoor air temperature rises to 80°F, the outdoor fan is set to HIGH.

4-5 Outdoor Fan Speed Control (CL1822)

- When the outdoor air temperature falls below 66°F, the outdoor fan speed switches from HIGH to relative adjustment.
- The speed of fan rotation follows an oblique line under the outdoor and indoor air temperature conditions as shown in the diagram below.

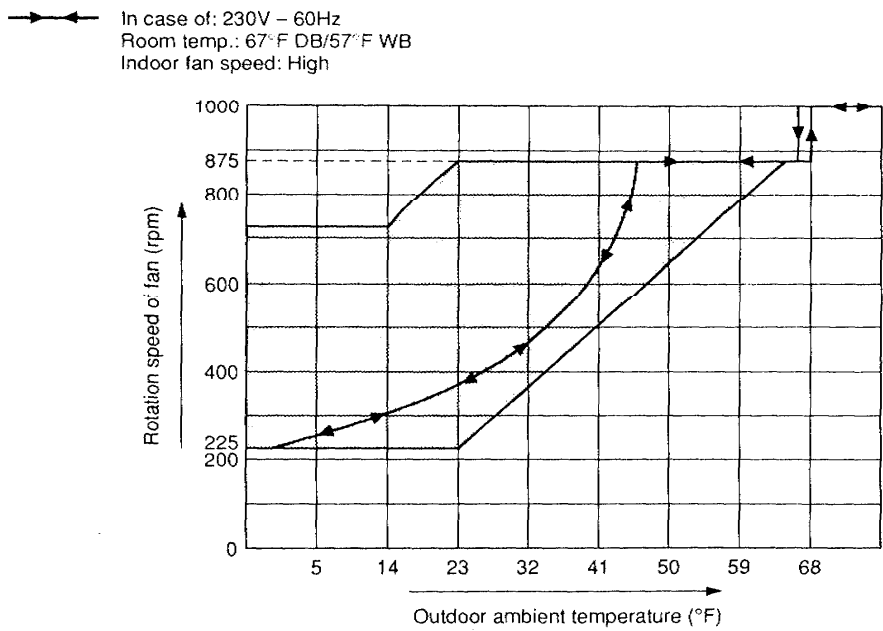

5. ELECTRICAL DATA

● Schematic Diagram

KS1822 / C1822

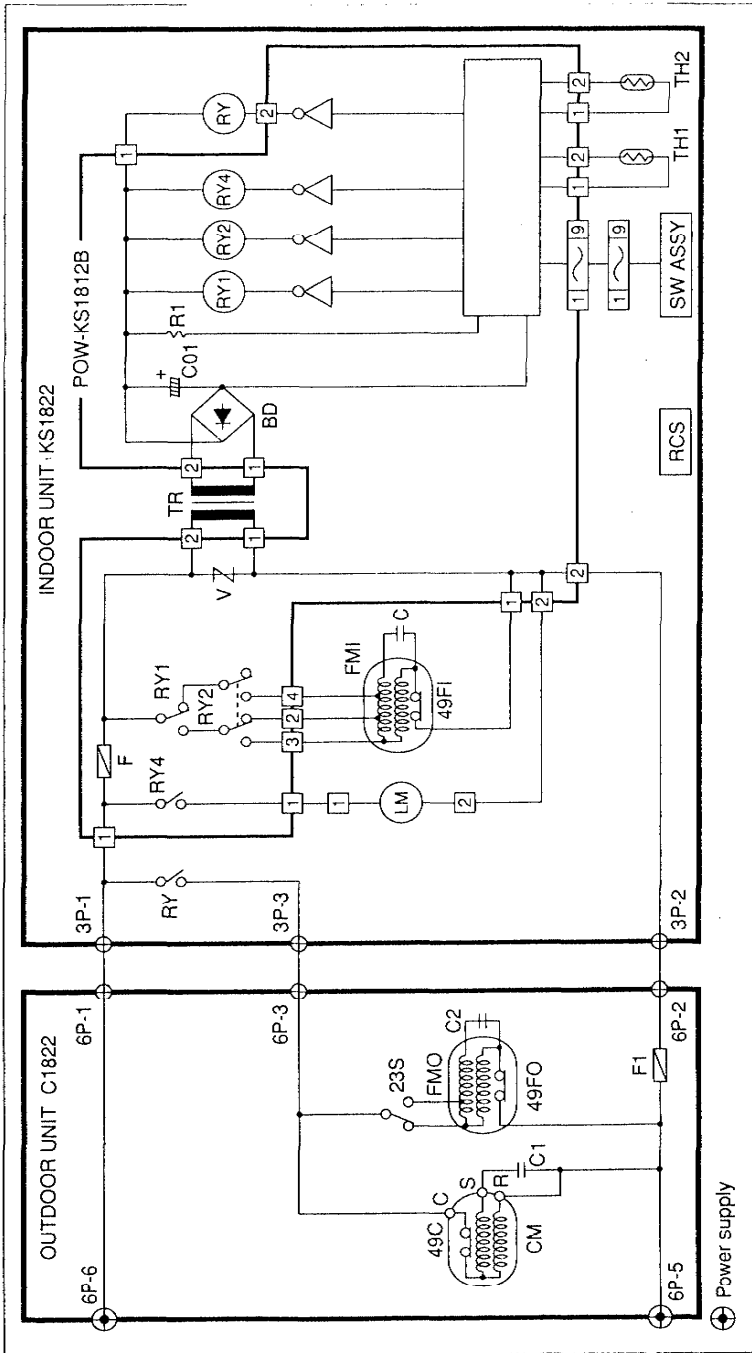

Symbol	Description	Symbol	Description
OUTDOOR UNIT		TR	TRANSFORMER
CM	COMPRESSOR MOTOR	RY	POWER RELAY
49C	COMPRESSOR MOTOR INTERNAL PROTECTOR	TH1	THERMISTOR (COIL TEMP. SENSOR)
23S	THERMOSTAT	TH2	THERMISTOR (ROOM TEMP. SENSOR)
FMO	OUTDOOR FAN MOTOR	SW ASSY	SWITCH ASSY SW-KS2412W
49FO	OUTDOOR FAN MOTOR INTERNAL PROTECTOR	RCS	WIRELESS REMOTE CONTROL UNIT RCS-KS2412W
C1, C2	CAPACITOR	POW-KS1812B	CONTROLLER PCB ASSY
F1	FUSE 250V, 3A	F	FUSE 250V, 3A
INDOOR UNIT		V	VARIABLE
LM	LOLVER MOTOR	BD	BRIDGE DIODE
FMI	INDOOR FAN MOTOR	CU1	CAPACITOR
49FI	INDOOR FAN MOTOR INTERNAL PROTECTOR	R1	RESISTOR
C	CAPACITOR	RY1, RY2, RY4	AUXILIARY RELAY

● Schematic Diagram

KS1822 / CL1822

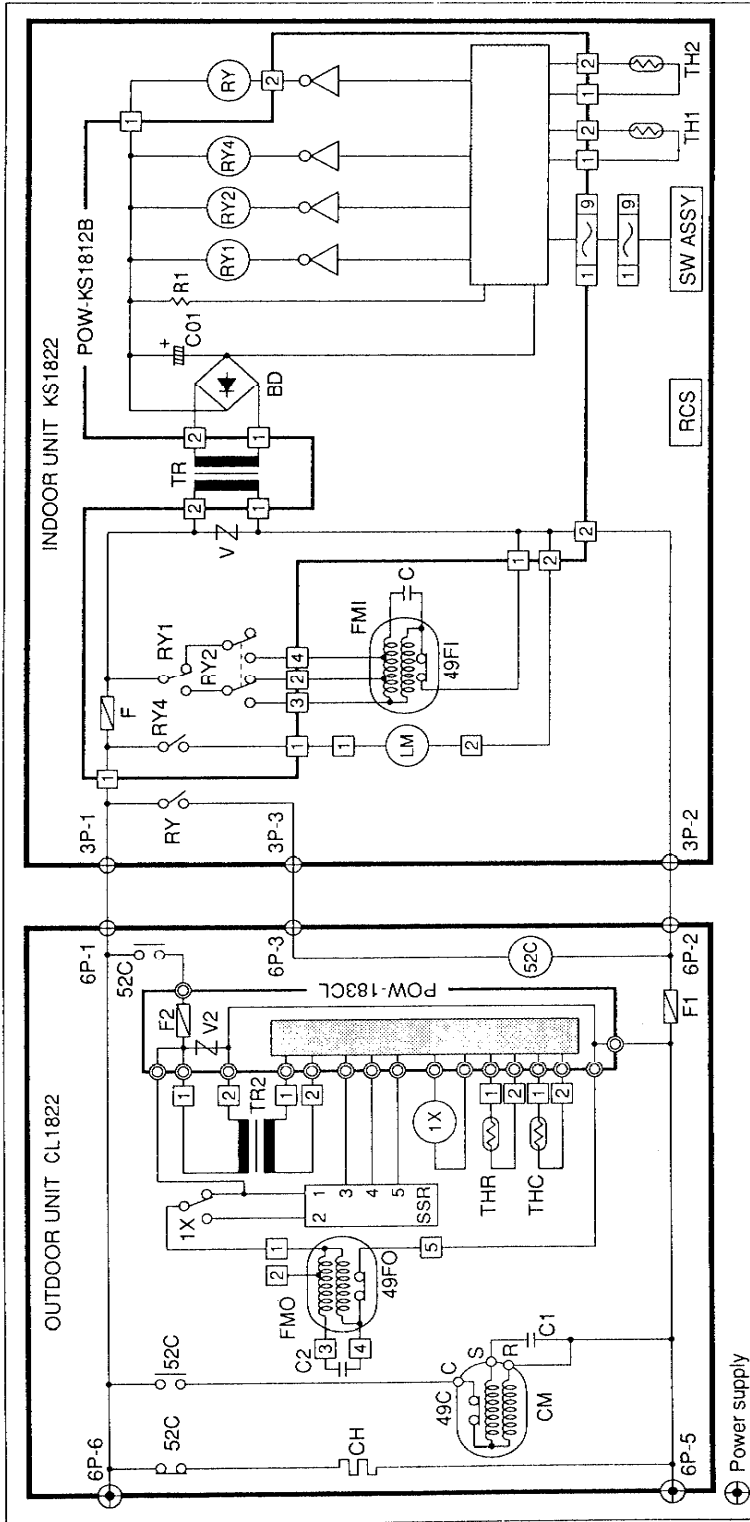

Symbol	Description	Symbol	Description
INDOOR UNIT		INDOOR UNIT	
LM	LOUVER MOTOR	LM	LOUVER MOTOR
FMI	INDOOR FAN MOTOR	FMI	INDOOR FAN MOTOR
49FI	INDOOR FAN MOTOR INTERNAL PROTECTOR	49FI	INDOOR FAN MOTOR INTERNAL PROTECTOR
C	CAPACITOR	C	CAPACITOR
TR	TRANSFORMER	TR	TRANSFORMER
RY	RELAY	RY	RELAY
TH1	THERMISTOR (COIL TEMP. SENSOR)	TH1	THERMISTOR (COIL TEMP. SENSOR)
TH2	THERMISTOR (ROOM TEMP. SENSOR)	TH2	THERMISTOR (ROOM TEMP. SENSOR)
SW ASSY	SWITCH ASSY SW-KS2412W	SW ASSY	SWITCH ASSY SW-KS2412W
RCS	WIRELESS REMOTE CONTROL UNIT RCS-KS212W	RCS	WIRELESS REMOTE CONTROL UNIT RCS-KS212W
POW-KS1812B	CONTROLLER PCB ASSY	POW-KS1812B	CONTROLLER PCB ASSY
F	FUSE 250V 3A	F	FUSE 250V 3A
V	VARISTOR	V	VARISTOR
BD	BRIDGE DIODE	BD	BRIDGE DIODE
CU1	CAPACITOR	CU1	CAPACITOR
R1	RESISTOR	R1	RESISTOR
RY1, RY2, RY4	AUXILIARY RELAY	RY1, RY2, RY4	AUXILIARY RELAY
OUTDOOR UNIT		OUTDOOR UNIT	
CH	CRANK CASE HEATER	CH	CRANK CASE HEATER
CM	COMPRESSOR MOTOR	CM	COMPRESSOR MOTOR
49C	COMPRESSOR MOTOR INTERNAL PROTECTOR	49C	COMPRESSOR MOTOR INTERNAL PROTECTOR
FM	OUTDOOR FAN MOTOR	FM	OUTDOOR FAN MOTOR
49FO	OUTDOOR FAN MOTOR INTERNAL PROTECTOR	49FO	OUTDOOR FAN MOTOR INTERNAL PROTECTOR
C1, C2	CAPACITOR	C1, C2	CAPACITOR
SSR	SOLID STATE RELAY	SSR	SOLID STATE RELAY
TR2	TRANSFORMER	TR2	TRANSFORMER
IX	RELAY	IX	RELAY
THR	THERMISTOR (AIR SENSOR)	THR	THERMISTOR (AIR SENSOR)
THC	THERMISTOR (COIL SENSOR)	THC	THERMISTOR (COIL SENSOR)
52C	ELECTRO-MAGNETIC CONTACTOR	52C	ELECTRO-MAGNETIC CONTACTOR
F1	FUSE 250V 3A	F1	FUSE 250V 3A
POW-183CL	CONTROLLER PCB ASSY	POW-183CL	CONTROLLER PCB ASSY
F2	FUSE 250V 5A	F2	FUSE 250V 5A
V2	VARISTOR	V2	VARISTOR

● Electric Wiring Diagram (PCB Assy)
 KS1822 / C1822

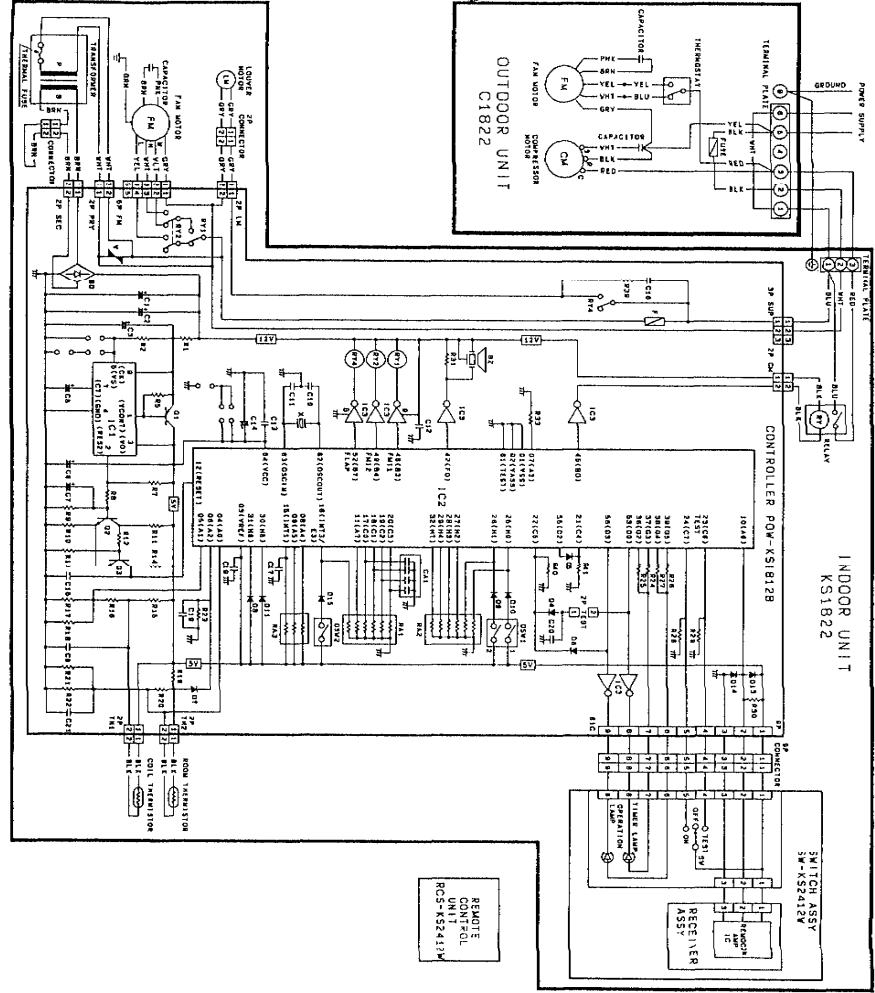

POW-KS1812B

Symbol	Description	Specifications
BZ101	BUZZER	PKM24SP3805
C1	CAPACITOR	2200 μ F 25V
C2	CAPACITOR	1 μ F 50V
C3	CAPACITOR	10 μ F 50V
C5	CAPACITOR	1 μ F 50V
C6	CAPACITOR	220 μ F 16V
C7	CAPACITOR	1 μ F 50V
C9	CAPACITOR	0.1 μ F 50V
C10	CAPACITOR	0.00003 μ F 50V
C11	CAPACITOR	0.00003 μ F 50V
C12	CAPACITOR	0.022 μ F 50V
C13	CAPACITOR	0.1 μ F 50V
C14	CAPACITOR	100 μ F 10V
C15	CAPACITOR	0.022 μ F 50V
C16	CAPACITOR	0.01 μ F 250V
C17	CAPACITOR	0.0047 μ F 50V
C18	CAPACITOR	0.022 μ F 50V
C19	CAPACITOR	0.022 μ F 50V
C20	CAPACITOR	0.022 μ F 50V
C21	CAPACITOR	0.1 μ F 50V
CA1	CAPACITOR	0.0047 μ F-4 50V
D4	DIODE	DS446
D5	DIODE	DS446
D6	DIODE	DS446
D7	DIODE	DS446
D8	DIODE	DS446
D9	DIODE	DS446
D10	DIODE	DS446
D11	DIODE	DS446
D13	DIODE	DS446
D14	DIODE	DS446
D15	DIODE	DS446
DSW1	SWITCH	SSGM 2P
DSW2	SWITCH	JKS1120-0401
DB	BRIDGE DIODE	DBA10C
F	FUSE	250V, 3A
IC1	IC	LA5693D
IC2	IC	TMS73C161-C76577
IC3	IC	LB1234
Q1	TRANSISTOR	2SA1289
Q2	TRANSISTOR	2SC536-E
Q3	TRANSISTOR	2SC536-E

POW-KS1812B

Symbol	Description	Specifications
R1	RESISTOR (CARBON)	5.6 Ω \pm 5% 1/2W
R2	RESISTOR (CARBON)	27K Ω \pm 5% 1/4W
R5	RESISTOR (CARBON)	390 Ω \pm 5% 1/4W
R7	RESISTOR (CARBON)	1K Ω \pm 5% 1/4W
R8	RESISTOR (CARBON)	27K Ω \pm 5% 1/4W
R9	RESISTOR (CARBON)	22K Ω \pm 5% 1/4W
R10	RESISTOR (CARBON)	560 Ω \pm 5% 1/4W
R11	RESISTOR (CARBON)	4.7K Ω \pm 5% 1/4W
R12	RESISTOR (CARBON)	5.6K Ω \pm 5% 1/4W
R13	RESISTOR (CARBON)	8.2K Ω \pm 5% 1/4W
R14	RESISTOR (CARBON)	4.7K Ω \pm 5% 1/4W
R15	RESISTOR (METAL)	12K Ω \pm 1% 1/4W
R16	RESISTOR (METAL)	750 Ω \pm 1% 1/4W
R17	RESISTOR (METAL)	6.8K Ω \pm 1% 1/4W
R18	RESISTOR (METAL)	10K Ω \pm 1% 1/4W
R19	RESISTOR (METAL)	180 Ω \pm 1% 1/4W
R20	RESISTOR (METAL)	15K Ω \pm 1% 1/4W
R21	RESISTOR (METAL)	6.2K Ω \pm 1% 1/4W
R22	RESISTOR (METAL)	11K Ω \pm 1% 1/4W
R23	RESISTOR (CARBON)	100K Ω \pm 5% 1/4W
R24	RESISTOR (CARBON)	270 Ω \pm 5% 1/4W
R25	RESISTOR (CARBON)	270 Ω \pm 5% 1/4W
R26	RESISTOR (CARBON)	270 Ω \pm 5% 1/4W
R27	RESISTOR (CARBON)	270 Ω \pm 5% 1/4W
R28	RESISTOR (CARBON)	5.6K Ω \pm 5% 1/4W
R29	RESISTOR (CARBON)	5.6K Ω \pm 5% 1/4W
R30	RESISTOR (CARBON)	100K Ω \pm 5% 1/4W
R31	RESISTOR (CARBON)	6.8K Ω \pm 5% 1/4W
R33	RESISTOR (CARBON)	56K Ω \pm 5% 1/4W
R39	RESISTOR (METAL)	100 Ω \pm 1% 1W
R40	RESISTOR (CARBON)	56K Ω \pm 5% 1/4W
R41	RESISTOR (CARBON)	56K Ω \pm 5% 1/4W
RA1	RESISTOR	56K Ω -6 \pm 5% 1/4W
RA2	RESISTOR	56K Ω -6 \pm 5% 1/4W
RA3	RESISTOR	20K Ω -3 \pm 5% 1/4W
RY1	RELAY	LZG-12HE
RY2	RELAY	VB12TBU
RY4	RELAY	LZG-12HE
V	VARIATOR	SNP001KD14
X	CRYSTAL	CSA-4MG
3P SUP	CONNECTOR	2-173270-3
5P FM	CONNECTOR	2-173270-5
2P PRY	CONNECTOR	8-173270-2
2P SEC	CONNECTOR	5273-02A
2P TEST	CONNECTOR	NHK-P2T-N
2P TH1	CONNECTOR	8-171825-2
2P TH2	CONNECTOR	2-171825-2
2P CM	CONNECTOR	5273-02A-BL
2P LM	CONNECTOR	2-173270-2

POW-183CL

Symbol	Description	Specifications
B0	BRIDGE DIODE	DBA10C
C1	CAPACITOR	470µF 50V
C2	CAPACITOR	22µF 25V
C3	CAPACITOR	0.047µF 50V
C4	CAPACITOR	0.047µF 50V
C5	CAPACITOR	0.022µF 50V
C6	CAPACITOR	22µF 25V
C7	CAPACITOR	22µF 25V
C8	CAPACITOR	22µF 25V
C9	CAPACITOR	22µF 25V
C10	CAPACITOR	22µF 25V
C11	CAPACITOR	470µF 16V
C12	CAPACITOR	100µF 16V
C13	CAPACITOR	22µF 25V
C14	CAPACITOR	22µF 25V
C15	CAPACITOR	100µF 16V
C16	CAPACITOR	22µF 25V
C1	CAPACITOR	0.22µF 630V
C01	CAPACITOR	0.033µF 630V
C02	CAPACITOR	0.033µF 630V
D1	DIODE	DSF10C
D2 to D12	DIODE	DS446
FUSE	FUSE	250V, 5A
IC1	IC	NJM2902
IC2	IC	LA6339
IC3	IC	NJM2902
Q1	TRANSISTOR	2SC 3400
Q2	TRANSISTOR	2SC2274E
L1	FILTER COIL	SN12-500
L2	FILTER COIL	SN12-500
R1	RESISTOR (OXIDE)	240Ω ±5% 2W
R2	RESISTOR (CARBON)	5.6KΩ ±5% 1/4W
R3	RESISTOR (CARBON)	18KΩ ±5% 1/4W
R4	RESISTOR (CARBON)	3.3KΩ ±5% 1/4W
R5	RESISTOR (CARBON)	22KΩ ±5% 1/4W
R6	RESISTOR (CARBON)	5.1KΩ ±5% 1/4W
R7	RESISTOR (CARBON)	22KΩ ±5% 1/4W
R8	RESISTOR (CARBON)	10KΩ ±5% 1/4W
R9	RESISTOR (CARBON)	910KΩ ±5% 1/4W
R10	RESISTOR (CARBON)	1MΩ ±5% 1/4W
R11	RESISTOR (CARBON)	150KΩ ±5% 1/4W
R12	RESISTOR (CARBON)	300KΩ ±5% 1/4W
R13	RESISTOR (CARBON)	5.6KΩ ±5% 1/4W

POW-183CL

Symbol	Description	Specifications
R14	RESISTOR (CARBON)	7.5KΩ ±5% 1/4W
R15	RESISTOR (CARBON)	1.2KΩ ±5% 1/4W
R16	RESISTOR (CARBON)	7.5KΩ ±5% 1/4W
R17	RESISTOR (CARBON)	2.2KΩ ±1% 1/4W
R18	RESISTOR (METAL)	27KΩ ±1% 1/4W
R19	RESISTOR (METAL)	10KΩ ±1% 1/4W
R20	RESISTOR (CARBON)	56KΩ ±5% 1/4W
R21	RESISTOR (METAL)	27KΩ ±1% 1/4W
R22	RESISTOR (METAL)	100KΩ ±1% 1/4W
R23	RESISTOR (METAL)	27KΩ ±1% 1/4W
R24	RESISTOR (METAL)	8.2KΩ ±1% 1/4W
R25	RESISTOR (CARBON)	51KΩ ±5% 1/4W
R26	RESISTOR (CARBON)	13KΩ ±5% 1/4W
R27	RESISTOR (CARBON)	13KΩ ±5% 1/4W
R28	RESISTOR (METAL)	27KΩ ±1% 1/4W
R29	RESISTOR (METAL)	12KΩ ±1% 1/4W
R30	RESISTOR (CARBON)	68KΩ ±5% 1/4W
R31	RESISTOR (METAL)	1.5KΩ ±1% 1/4W
R32	RESISTOR (METAL)	27KΩ ±1% 1/4W
R33	RESISTOR (CARBON)	36KΩ ±5% 1/4W
R34	RESISTOR (CARBON)	120KΩ ±5% 1/4W
R35	RESISTOR (METAL)	510KΩ ±1% 1/4W
R36	RESISTOR (METAL)	12KΩ ±1% 1/4W
R37	RESISTOR (METAL)	36KΩ ±1% 1/4W
R38	RESISTOR (METAL)	1.8KΩ ±1% 1/4W
R39	RESISTOR (CARBON)	75KΩ ±5% 1/4W
R40	RESISTOR (METAL)	560Ω ±1% 1/4W
R41	RESISTOR (METAL)	300Ω ±1% 1/4W
R42		
R43	RESISTOR (CARBON)	100Ω ±5% 1/4W
R44	RESISTOR (METAL)	82KΩ ±1% 1/4W
R45		
R46		
R47	RESISTOR (CARBON)	10Ω ±5% 1/4W
R48	RESISTOR (METAL)	10KΩ ±1% 1/4W
R49	RESISTOR (METAL)	820Ω ±1% 1/4W
R50	RESISTOR (CARBON)	22KΩ ±5% 1/4W
R51	RESISTOR (CARBON)	150KΩ ±5% 1/4W
R52	RESISTOR (CARBON)	200Ω ±5% 1/4W
R53	RESISTOR (CARBON)	4.7KΩ ±5% 1/4W
R54	RESISTOR (CARBON)	75KΩ ±5% 1/4W
V	VARISTOR	SNR-A420K
ZD1	ZENER DIODE	G7B-12C
ZD2	ZENER DIODE	GZA5, 6Y

6. TROUBLESHOOTING

6-1 Check before and after troubleshooting.

(1) Check power supply wiring.

- Check that power supply wires are correctly connected to terminals No. 5 and No. 6 on the 6P terminal plate in the outdoor unit.

(2) Check inter-unit wiring.

- Check that inter-unit wires are correctly connected to indoor unit from outdoor unit.

Power supply:
60Hz, single-phase, 230/208V

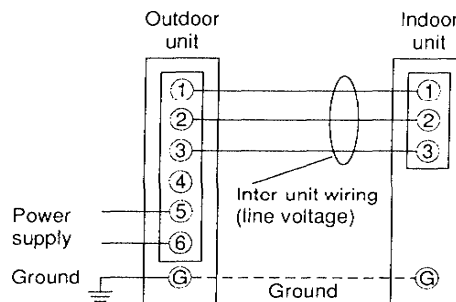

(3) Check power supply.

- Check that voltage is in specified range ($\pm 10\%$ of the rating).
- Check that power is being supplied.



WARNING:

If the following troubleshooting must be done with power being supplied, be careful about any uninsulated live part that can cause **ELECTRIC SHOCK**.

(4) Check lead wires and connectors in indoor and outdoor units.

- Check that coating of lead wires is not damaged.
- Check that lead wires and connectors are connected firmly.
- Check that wiring is correct.

(5) Reference

(a) Condition of general cooling operation

- ON/OFF operation button..... ON
- COOL/FAN selector switch COOL
- SWEEP button..... ON
- Indoor fan speed HIGH
- Thermo..... ON
- Outdoor air temperature..... above 79°F

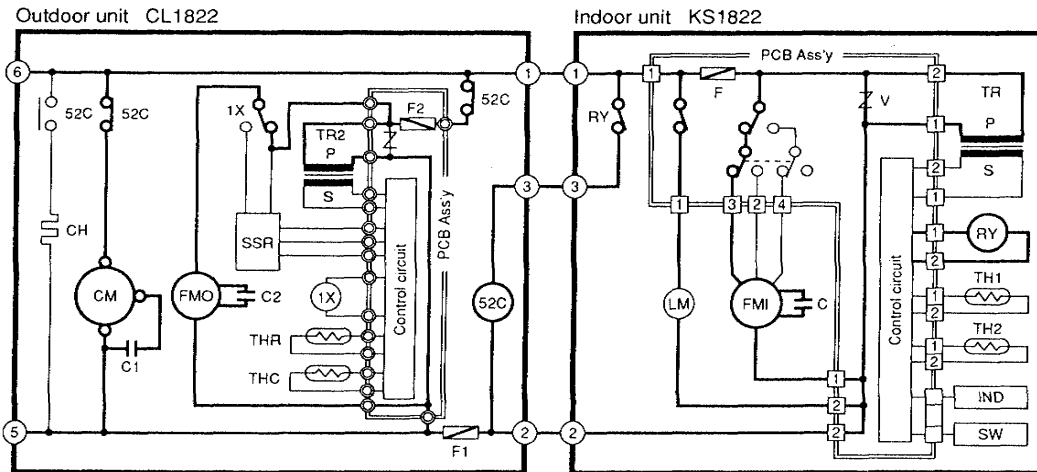
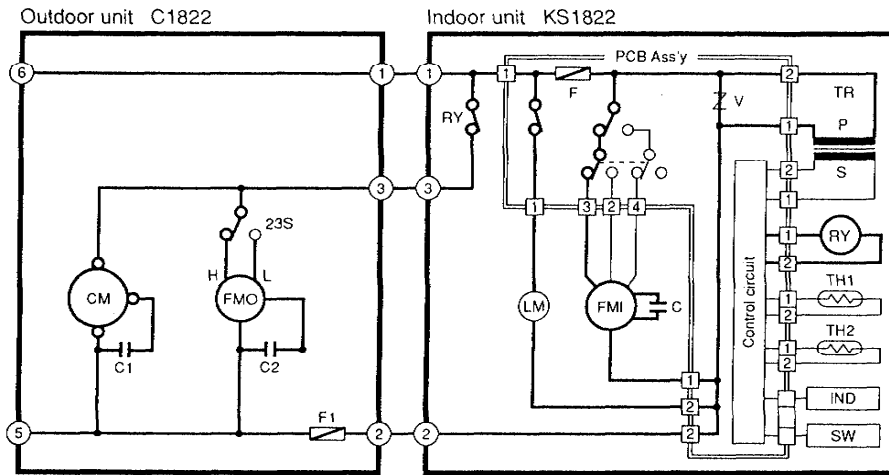

(b) Condition of cooling operation under low ambient temperature

- ON/OFF operation button..... ON
- COOL/FAN selector switch COOL
- SWEEP button ON
- Indoor fan speed LOW
- Thermo..... ON
- Outdoor air temperature..... below 68°F

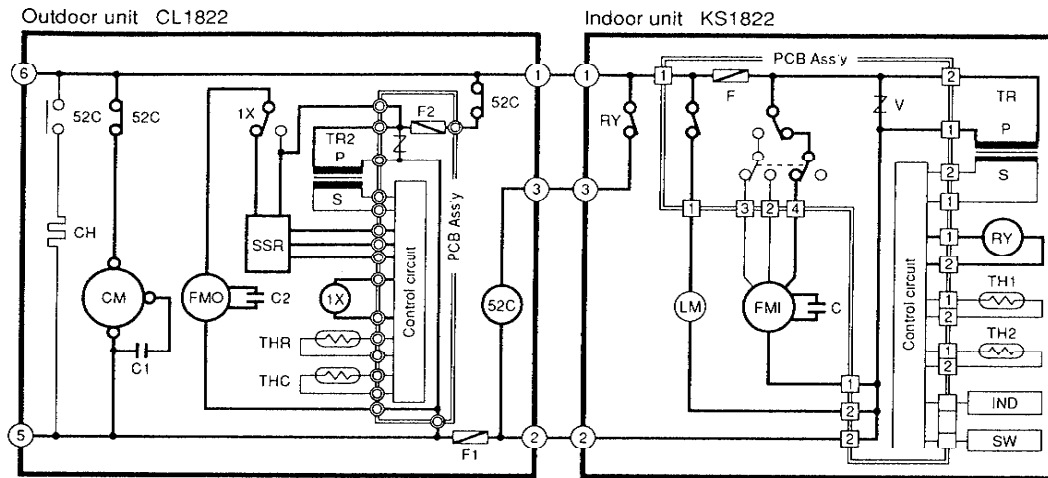

6-2 Air conditioner does not operate.

(1) Circuit breaker trips (or fuse blows).

(a) When circuit breaker is set to ON, it trips in a few moments (resetting is not possible).

- There is a possibility of ground fault.
- Measure insulation resistance.

If resistance value is $1M\Omega$ or less, insulation is defective ("NO").

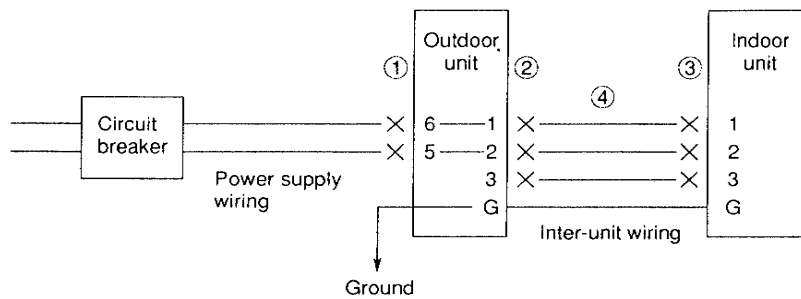

* Set circuit breaker to OFF.

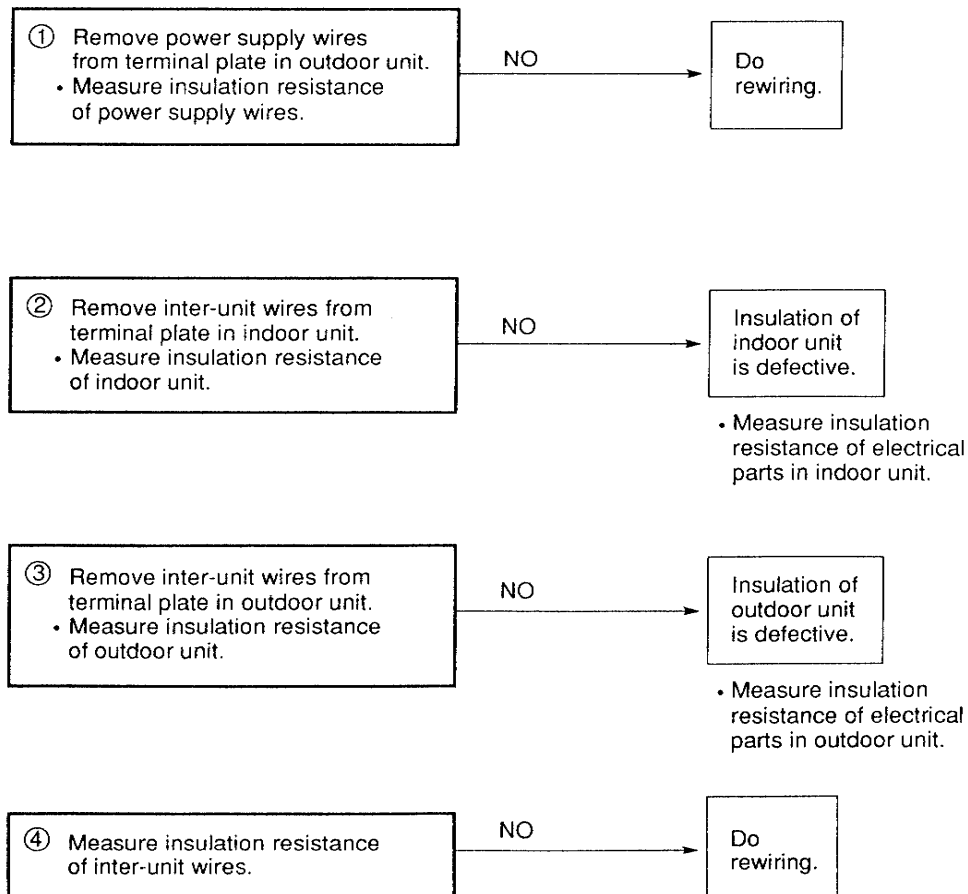

(b) Circuit breaker trips in several minutes after turning air conditioner ON.

- There is a possibility of short circuit.

• Check capacity of circuit breaker.
Is capacity of circuit breaker suitable?

Replace it with suitable one (larger capacity).

• Measure resistance of compressor motor winding.

• Measure resistance of outdoor fan motor winding. ➔ Only C1822

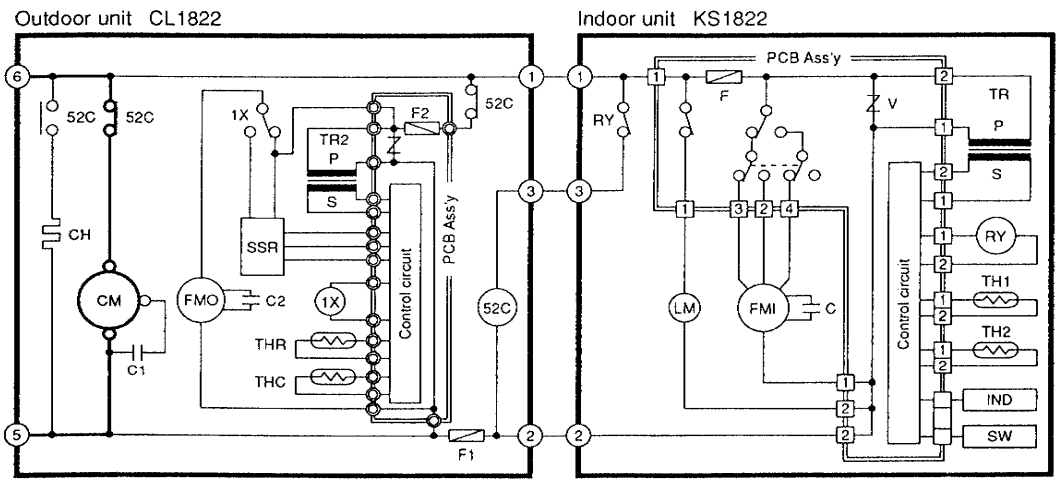
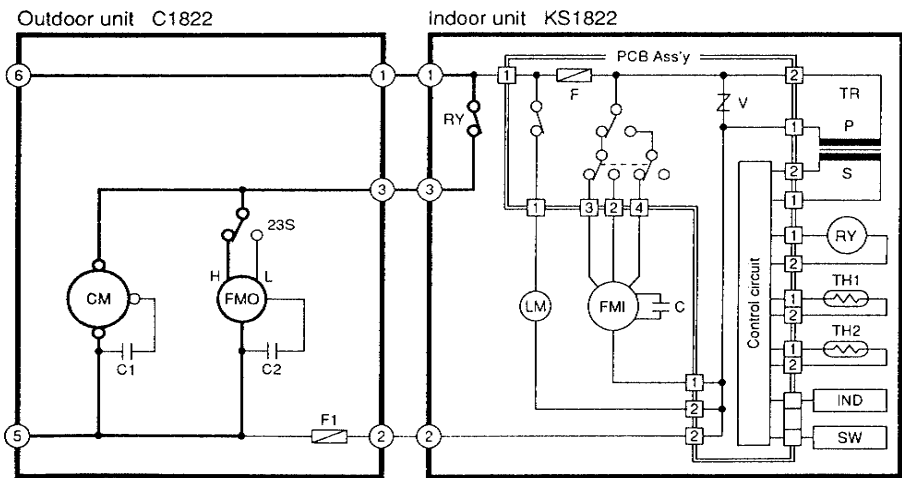

(2) Neither indoor unit nor outdoor unit runs.

(a) Power is not supplied.

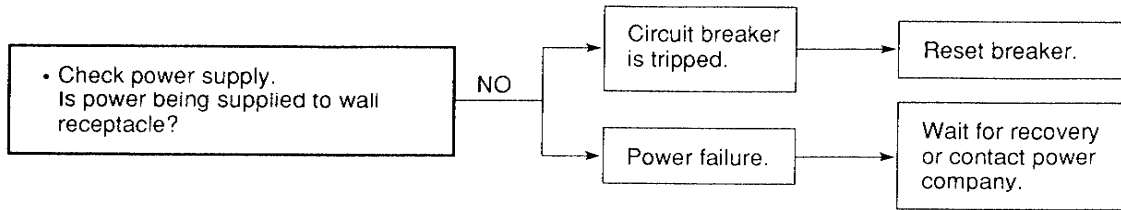

(b) Check remote control unit.

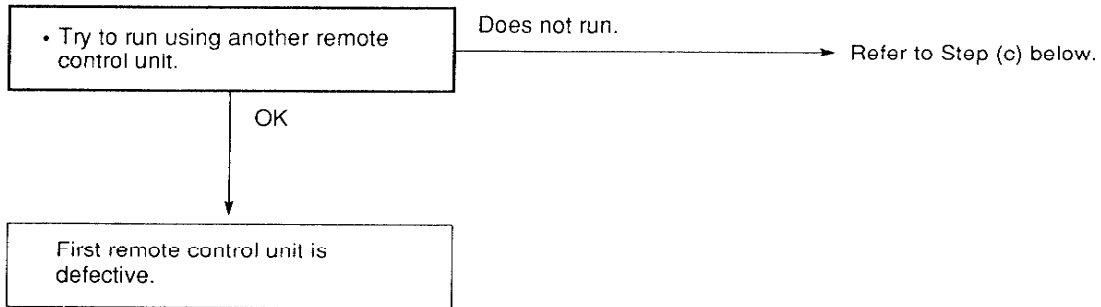

(c) Check OPERATION selector switch in indoor unit.

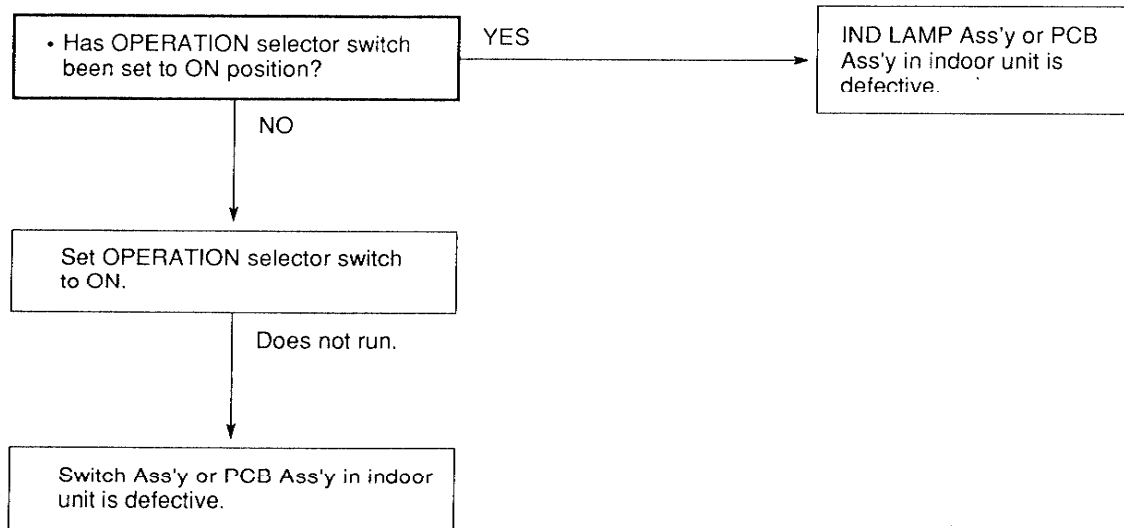

(Neither indoor unit nor outdoor unit runs.) (cont'd)

(d) Check fuse in indoor unit.

• Check fuse in indoor unit for continuity.

If fuse blows,

• Measure resistance of louver motor winding.

OK

• Measure coil resistance of electro-magnetic contactor.

➡ Only CL1822

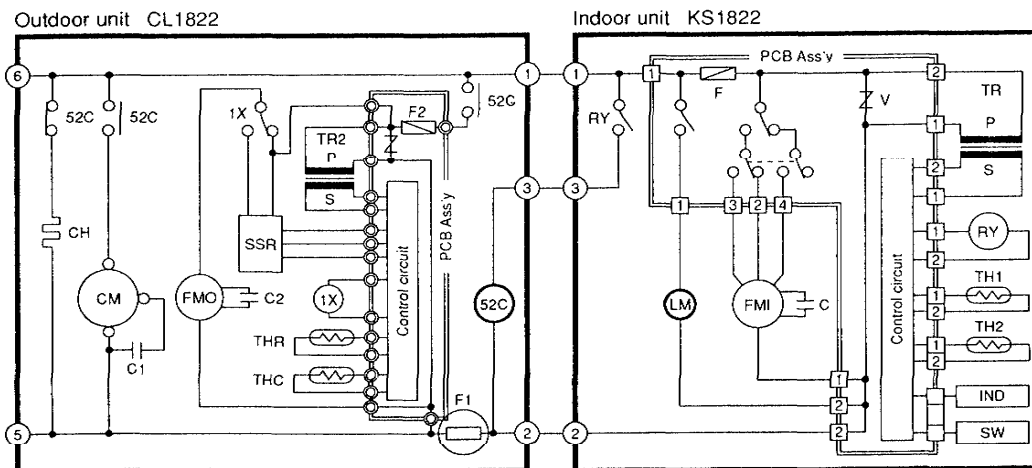
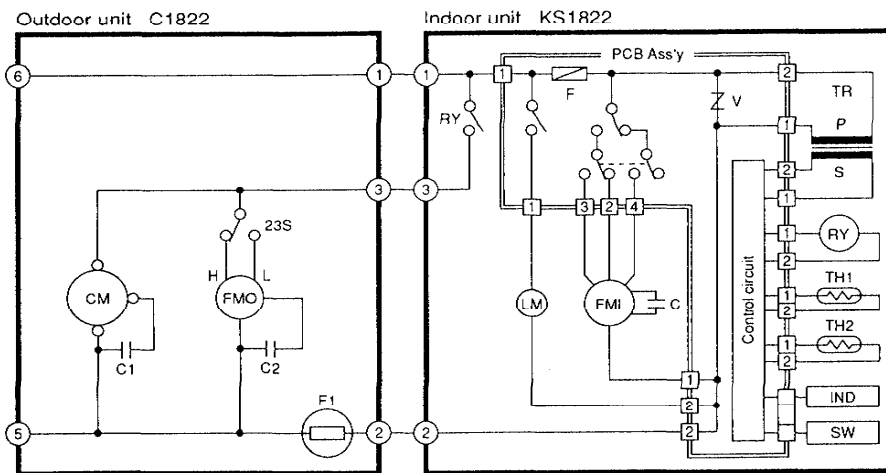

(Neither indoor unit nor outdoor unit runs.) (cont'd)

(e) Check transformer in indoor unit.

- Measure resistance of primary and secondary winding.

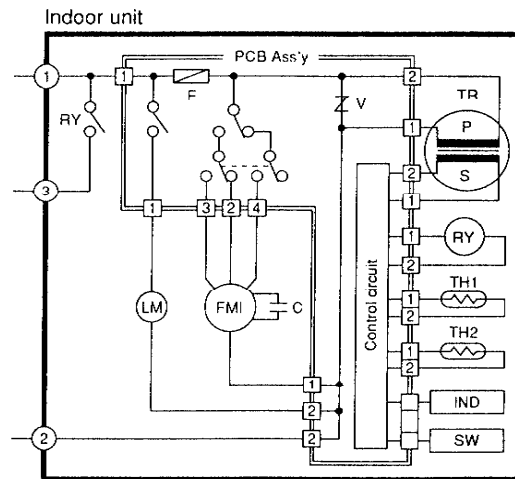

(f) Check fuse on PCB Ass'y in indoor unit.

- Check fuse on PCB Ass'y in indoor unit for continuity.

If fuse blows,

- Measure resistance of primary winding of transformer.

OK

- Measure resistance of indoor fan motor winding.

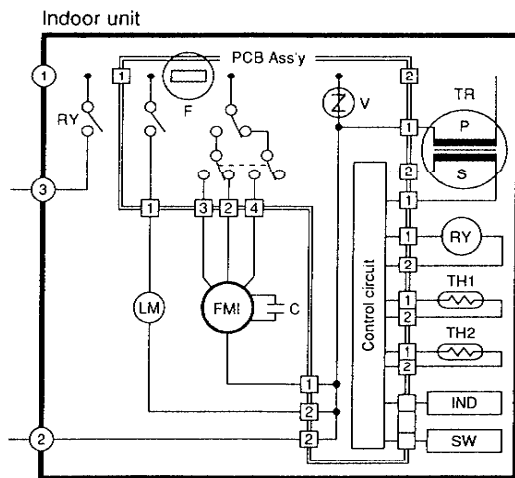

(3) Only outdoor unit does not run.

(a) Check COOL/FAN selector switch of remote control unit.



(b) Outdoor unit does not run when air conditioner is in following conditions.

- During thermo OFF (when the room temperature is below the setting temperature).
- During freeze prevention (for at least 6 minutes).

• Check setting temperature

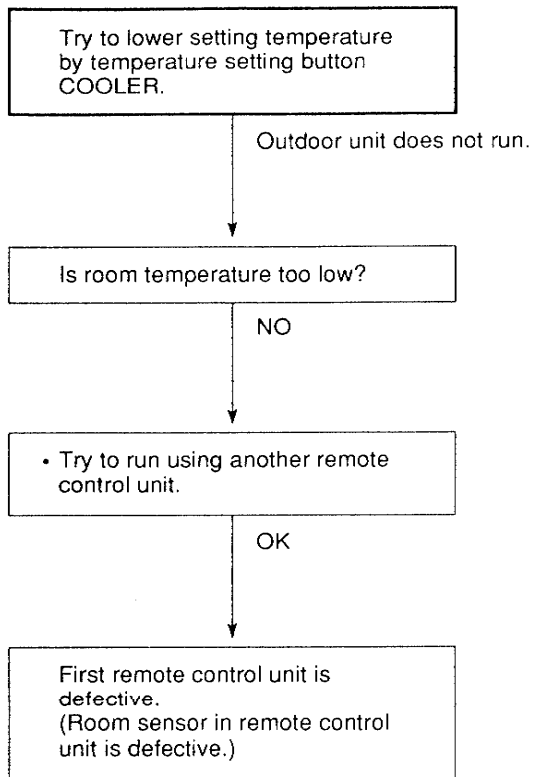

6-3 A particular component of air conditioner does not operate.

(1) Only indoor fan does not run.

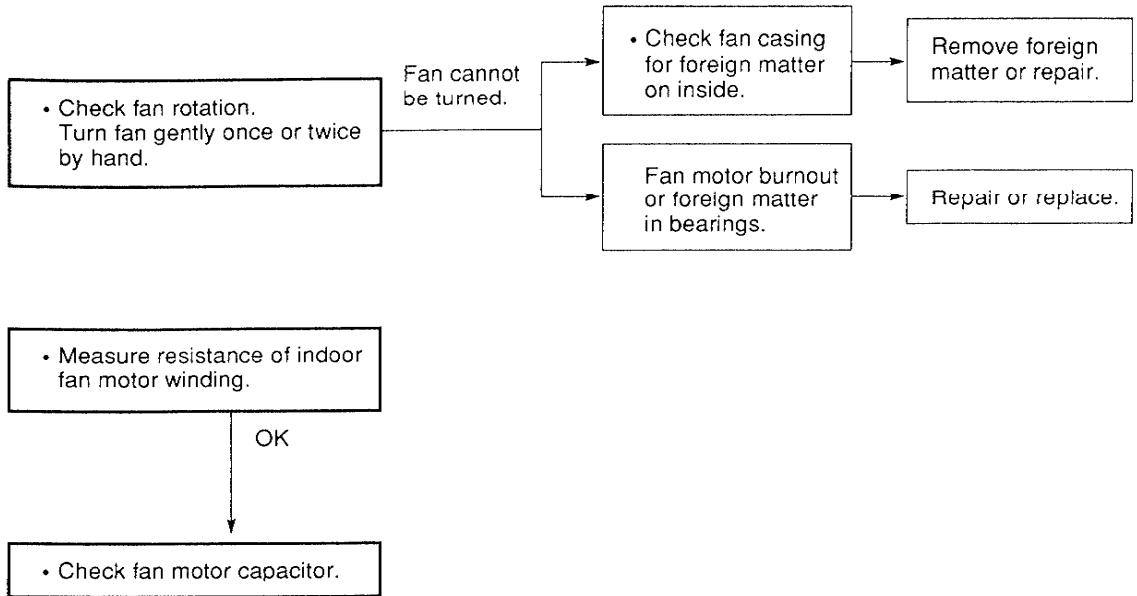

(2) Only outdoor fan does not run.

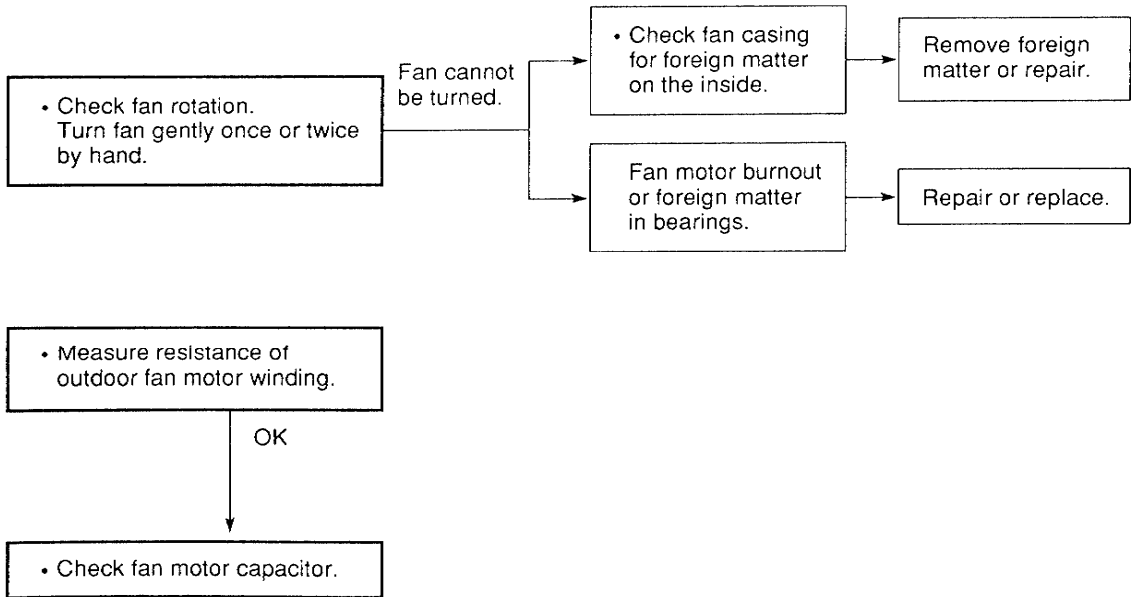

(3) Only outdoor fan does not run for CL1822.

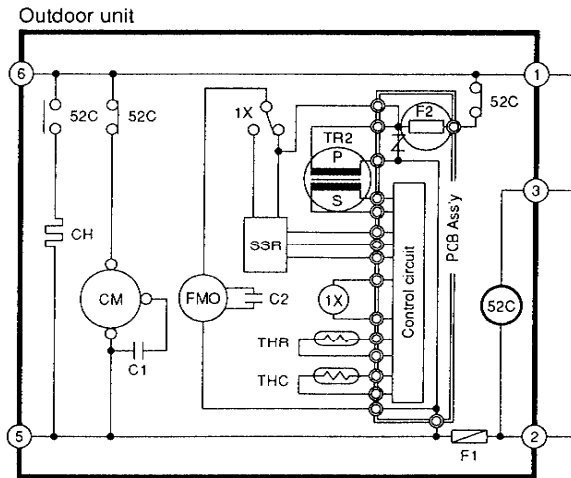
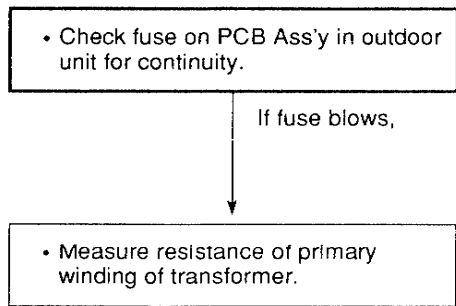

(4) Only compressor does not run.

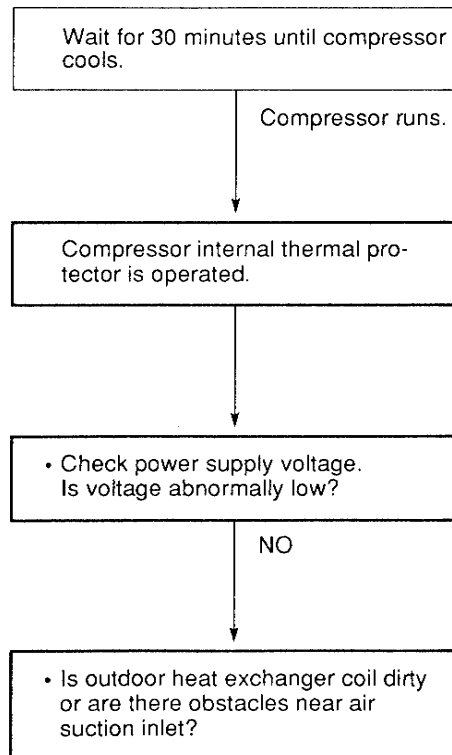
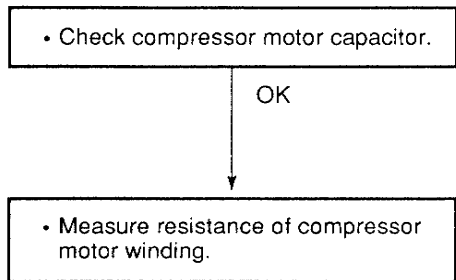

6-4 Air conditioner operates, but abnormalities occur.

(1) Poor Cooling

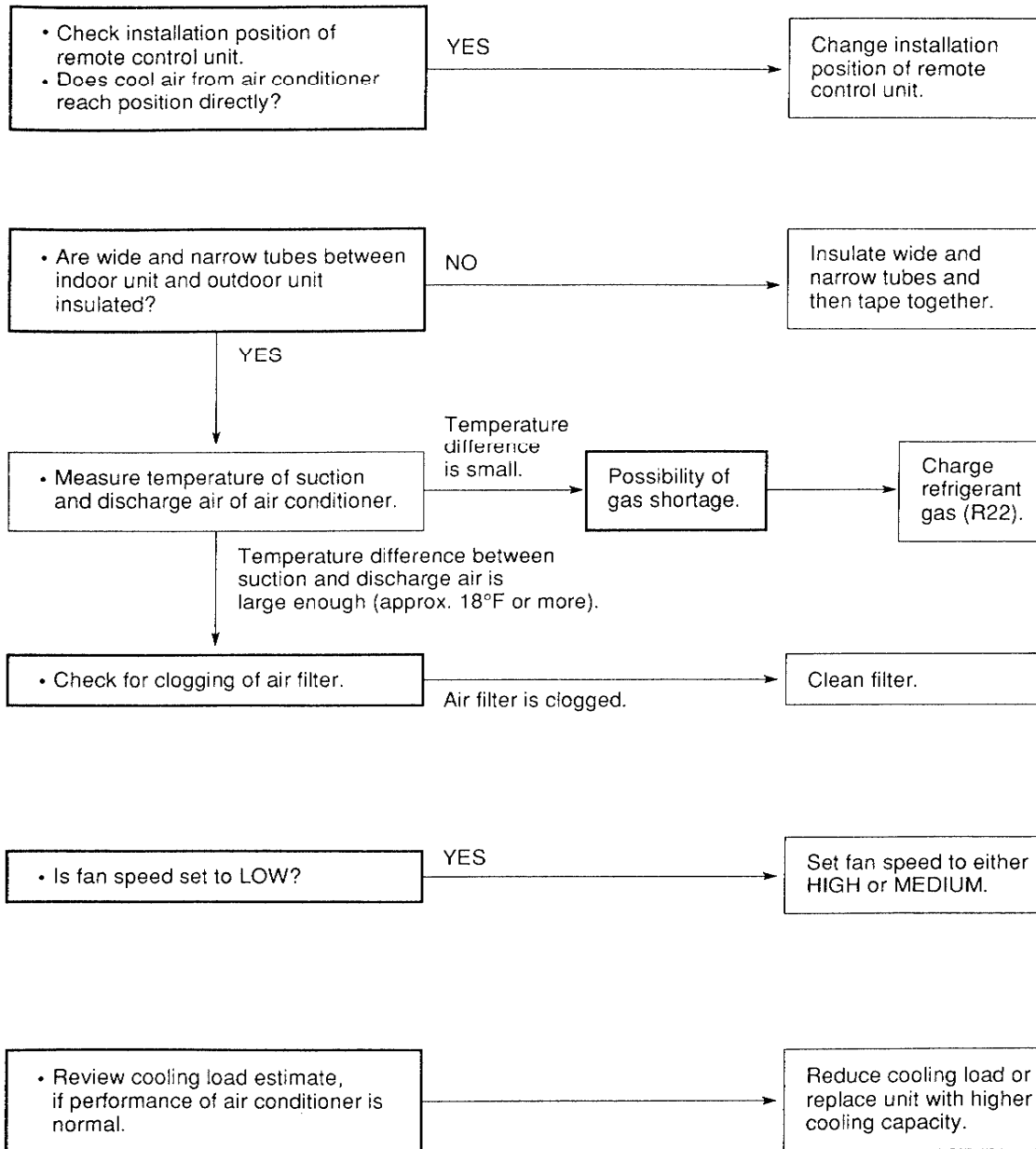

(2) Excessive Cooling

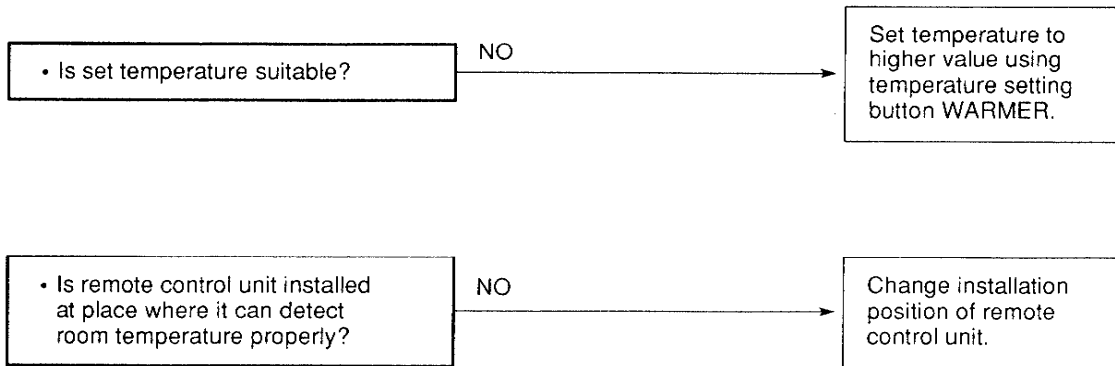

6-5 Indoor (heat exchanger) coil temperature sensor (TH1) is defective.

(1) Open

Even though the air conditioner does not thermo OFF, compressor and outdoor fan repeat ON for 10 minutes and OFF for 6 minutes.

(2) Shortage

When dehumidified water freezes in the indoor coil, the freeze prevention function does not work.

7. CHECKING ELECTRICAL COMPONENTS

7-1 Measurement of Insulation Resistance

- The insulation is in good condition if the resistance exceeds 1 MΩ.

(1) Power Supply Wires

Clamp the grounded wire of the power supply wires with the lead clip of the insulation resistance tester and measure the resistance by placing a probe on either of the power wires. (Fig. 1)

Then measure the resistance between the grounded wire and the other power wires. (Fig. 1)

(2) Indoor Unit

Clamp an aluminum plate fin or copper tube with the lead clip of the insulation resistance tester and measure the resistance by placing a probe on ①, and then ② on the terminal plate. (Fig. 2)

(3) Outdoor Unit

Clamp a metallic part of the unit with the lead clip of the insulation resistance tester and measure the resistance by placing a probe on ⑤, and then ⑥ on the terminal plate. (Fig. 2)

(4) Measurement of Insulation Resistance for Electrical Parts

Disconnect the lead wires of the desired electric part from terminal plate, PCB Ass'y, capacitor, etc. Similarly disconnect the connector. Then measure the insulation resistance. (Figs. 1 to 4)

Refer to Electric Wiring Diagram.

Note: If the probe cannot enter the poles because the hole is too narrow then use a probe with a thinner pin.

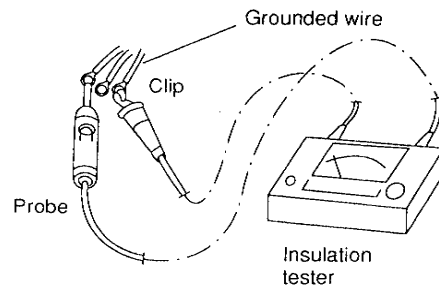

Fig. 1

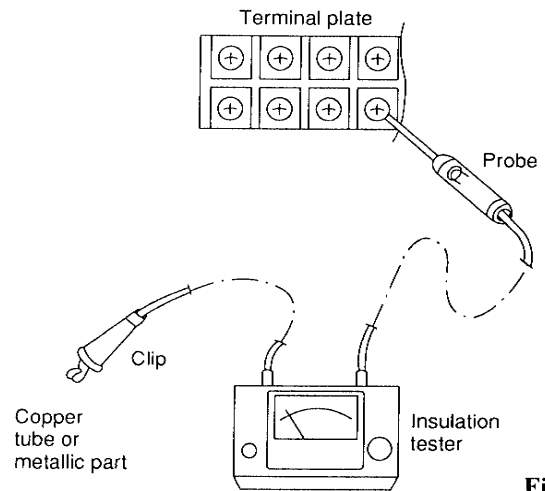

Fig. 2

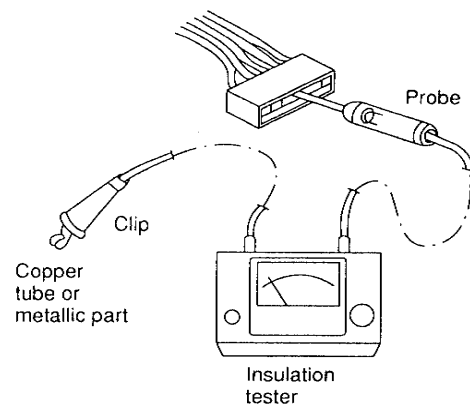

Fig. 3

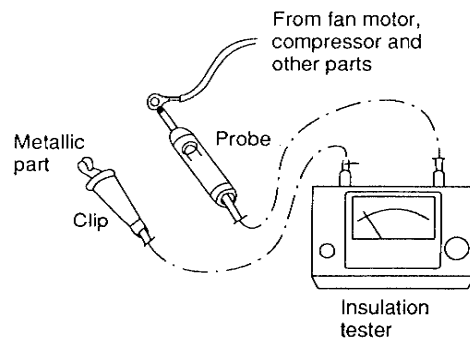

Fig. 4

7-2 Checking Continuity of Fuse on PCB Ass'y

- Check for continuity using a multimeter as shown in Fig. 5.

Note:

Method Used to Replace Fuse on PCB Ass'y

1. Remove the PCB Ass'y from the electrical component box.
2. Pull out the fuse at the metal clasp using pliers while heating the soldered leads on the back side of the PCB Ass'y with a soldering iron (30W or 60W). (Fig. 6)
3. Remove the fuse ends one by one. For replacement, insert a fuse of the same rating and solder it. (Allow time to radiate heat during soldering so that the fuse does not melt.)



CAUTION:

When replacing the fuse, be sure not to break down the varistor.

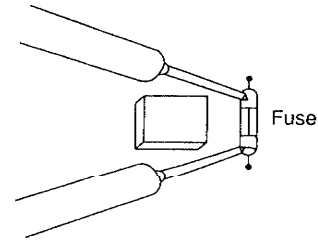

Fig. 5

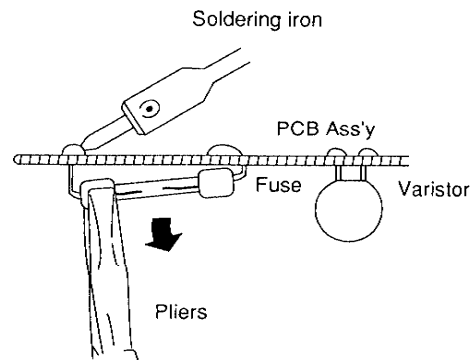

Fig. 6

7-3 Checking Motor Capacitor

Remove the lead wires from the capacitor terminals, and then place a probe on the capacitor terminals as shown in Fig. 7. Observe the deflection of the pointer, setting the resistance measuring range of the multimeter to the maximum value.

The capacitor is "good" if the pointer bounces to a great extent and then gradually returns to its original position.

The range of deflection and deflection time differ according to the capacity of the capacitor.

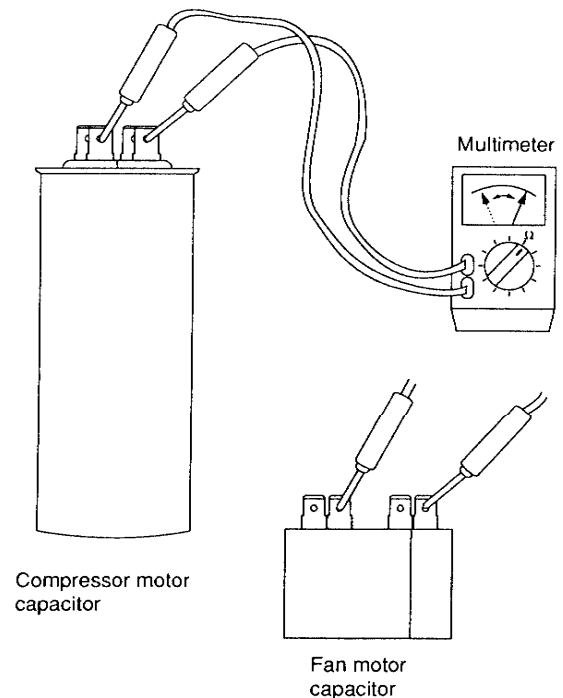

Fig. 7

7-4 Appearance of Electrical Parts

(1) Relay

DFU12D1-F (M)

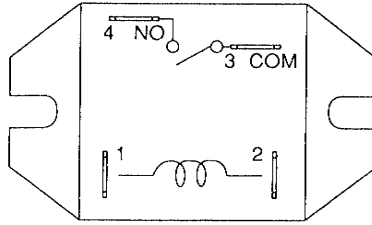

Fig. 8

(2) Thermostat

MQT5S 27YZ

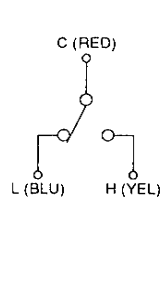

Fig. 9

(3) Electro-Magnetic Contactor

CLK-16E3-21

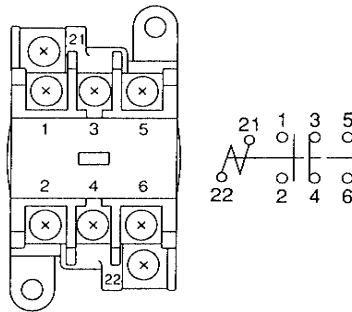

Fig. 10

(4) Relay

MY2F-T1-USTS

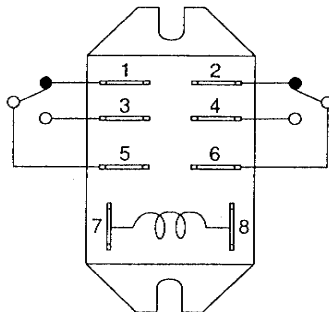

Fig. 11

(4) SSR (solid state relay)

G3L-205TL-TS1

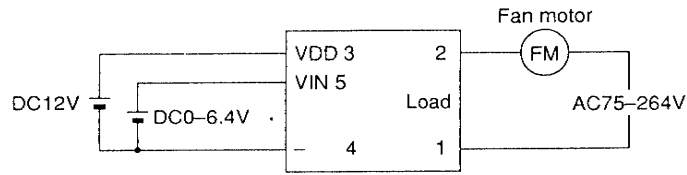
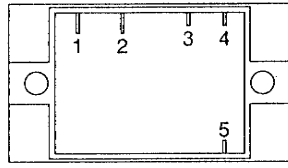

Fig. 12

Free Manuals Download Website

<http://myh66.com>

<http://usermanuals.us>

<http://www.somanuals.com>

<http://www.4manuals.cc>

<http://www.manual-lib.com>

<http://www.404manual.com>

<http://www.luxmanual.com>

<http://aubethermostatmanual.com>

Golf course search by state

<http://golfingnear.com>

Email search by domain

<http://emailbydomain.com>

Auto manuals search

<http://auto.somanuals.com>

TV manuals search

<http://tv.somanuals.com>