

2004 Saturn L-Series Owner Manual

Seats and Restraint Systems	1-1	Driving Your Vehicle	4-1
Front Seats	1-3	Your Driving, the Road, and Your Vehicle	4-2
Rear Seats	1-8	Towing	4-32
Safety Belts	1-11	Service and Appearance Care	5-1
Child Restraints	1-35	Service	5-3
Air Bag Systems	1-62	Fuel	5-5
Restraint System Check	1-72	Checking Things Under the Hood	5-10
Features and Controls	2-1	Bulb Replacement	5-46
Keys	2-3	Windshield Wiper Blade Replacement	5-53
Doors and Locks	2-9	Tires	5-54
Windows	2-16	Appearance Care	5-82
Theft-Deterrent Systems	2-18	Vehicle Identification	5-90
Starting and Operating Your Vehicle	2-19	Electrical System	5-91
Mirrors	2-33	Capacities and Specifications	5-98
OnStar® System	2-40	Maintenance Schedule	6-1
Storage Areas	2-41	Maintenance Schedule	6-2
Sunroof	2-45	Customer Assistance and Information	7-1
Instrument Panel	3-1	Customer Assistance and Information	7-2
Instrument Panel Overview	3-2	Reporting Safety Defects	7-9
Climate Controls	3-17	Index	1
Warning Lights, Gages, and Indicators	3-25		
Audio System(s)	3-41		



SATURN and the SATURN Emblem are registered trademarks of Saturn Corporation. GM and the GM Emblem are registered trademarks of General Motors Corporation.

This manual includes the latest information at the time it was printed. We reserve the right to make changes after that time without further notice.

Please keep this manual in your vehicle, so it will be there if you ever need it when you're on the road. If you sell the vehicle, please leave this manual in it so the new owner can use it.

Canadian Owners

A French language copy of this manual can be obtained from your dealer or from:

Helm, Incorporated
P.O. Box 07130
Detroit, MI 48207

How to Use This Manual

Many people read the owner manual from beginning to end when they first receive their new vehicle. If you do this, it can help you learn about the features and controls for the vehicle. Pictures and words work together in the owner manual to explain things.

Index

A good place to look for what you need is the Index in back of the manual. It is an alphabetical list of what is in the manual, and the page number where you will find it.

Litho in U.S.A.
Part No. 04LSERIES B FIRST EDITION

© Copyright General Motors Corporation 11/04/03
All Rights Reserved

Safety Warnings and Symbols

You will find a number of safety cautions in this book. We use a box and the word CAUTION to tell you about things that could hurt you if you were to ignore the warning.

 **CAUTION:**

These mean there is something that could hurt you or other people.

In the caution area, we tell you what the hazard is. Then we tell you what to do to help avoid or reduce the hazard. Please read these cautions. If you don't, you or others could be hurt.

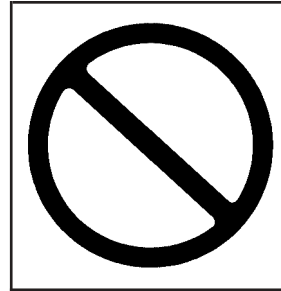

You will also find a circle with a slash through it in this book. This safety symbol means "Don't," "Don't do this" or "Don't let this happen."

Vehicle Damage Warnings

Also, in this manual you will find these notices:

Notice: These mean there is something that could damage your vehicle.

A notice tells about something that can damage your vehicle. Many times, this damage would not be covered by your vehicle's warranty, and it could be costly. But the notice will tell you what to do to help avoid the damage.

When you read other manuals, you might see CAUTION and NOTICE warnings in different colors or in different words.

There are also warning labels on your vehicle. They use the same words, CAUTION or NOTICE.

































Vehicle Symbols

The vehicle has components and labels that use symbols instead of text. Symbols are shown along with the text describing the operation or information relating to a specific component, control, message, gage, or indicator.

If you need help figuring out a specific name of a component, gage, or indicator, reference the following topics:

- Seats and Restraint Systems in Section 1
- Features and Controls in Section 2
- Instrument Panel Overview in Section 3
- Climate Controls in Section 3
- Warning Lights, Gages, and Indicators in Section 3
- Audio System(s) in Section 3
- Engine Compartment Overview in Section 5

These are some examples of symbols that may be found on the vehicle:

CAUTION POSSIBLE INJURY		LATCH BOTH LAP AND SHOULDER BELTS TO PROTECT OCCUPANT DO NOT TWIST SAFETY BELT WHEN ATTACHING	 	MASTER LIGHTING SWITCH		ENGINE COOLANT TEMP		FUSE BOX ACCESS			
PROTECT EYES BY SHIELDING		FASTEN SEAT BELTS		AIR BAG		TURN SIGNALS		BATTERY CHARGING SYSTEM		ENGINE COOLANT FAN	
CAUSTIC BATTERY ACID COULD CAUSE BURNS		MOVE SEAT FULLY REARWARD SECURE CHILD SEAT		DO NOT INSTALL A REAR-FACING CHILD RESTRAINT IN THIS SEATING POSITION		PARKING LAMPS		BRAKE		FUEL	
AVOID SPARKS OR FLAMES		PULL BELT OUT COMPLETELY THEN SECURE CHILD SEAT		DO NOT INSTALL A FORWARD-FACING CHILD RESTRAINT IN THIS SEATING POSITION		HAZARD WARNING FLASHER		COOLANT		OWNER'S MANUAL	
SPARK OR FLAME COULD EXPLODE BATTERY		POWER WINDOW		DOOR LOCK UNLOCK		DAYTIME RUNNING LAMPS		ENGINE OIL PRESSURE		SERVICE MANUAL	
						FOG LAMPS		ANTI-LOCK BRAKES			

 **NOTES**

Section 1 Seats and Restraint Systems

Front Seats	1-3	Child Restraints	1-35
Manual Seats	1-3	Older Children	1-35
Driver Seat Height Adjuster	1-3	Infants and Young Children	1-38
Six-Way Power Driver Seat	1-4	Child Restraint Systems	1-42
Manual Lumbar	1-4	Where to Put the Restraint	1-44
Heated Seats	1-5	Top Strap	1-46
Reclining Seatbacks	1-5	Top Strap Anchor Location	1-47
Head Restraints	1-7	Lower Anchorages and Top Tethers for Children (LATCH System)	1-50
Rear Seats	1-8	Securing a Child Restraint Designed for the LATCH System	1-52
Split Folding Rear Seat	1-8	Securing a Child Restraint in a Rear Seat Position (Sedan)	1-52
Safety Belts	1-11	Securing a Child Restraint in a Rear Outside Seat Position (Wagon)	1-54
Safety Belts: They Are for Everyone	1-11	Securing a Child Restraint in a Center Rear Seat Position (Wagon)	1-56
Questions and Answers About Safety Belts	1-15	Securing a Child Restraint in the Right Front Seat Position	1-58
How to Wear Safety Belts Properly	1-16	Air Bag Systems	1-62
Driver Position	1-16	Where Are the Air Bags?	1-64
Safety Belt Use During Pregnancy	1-24	When Should an Air Bag Inflate?	1-67
Right Front Passenger Position	1-25		
Rear Seat Passengers	1-25		
Rear Safety Belt Comfort Guides for Children and Small Adults	1-33		
Safety Belt Extender	1-35		

Section 1 Seats and Restraint Systems

What Makes an Air Bag Inflate?	1-68	Restraint System Check	1-72
How Does an Air Bag Restrain?	1-68	Checking Your Restraint Systems	1-72
What Will You See After an Air Bag Inflates?	1-69	Replacing Restraint System Parts After	
Servicing Your Air Bag-Equipped Vehicle	1-71	a Crash	1-73
Adding Equipment to Your Air Bag-Equipped			
Vehicle	1-72		

Front Seats

Manual Seats

CAUTION:

You can lose control of the vehicle if you try to adjust a manual driver's seat while the vehicle is moving. The sudden movement could startle and confuse you, or make you push a pedal when you do not want to. Adjust the driver's seat only when the vehicle is not moving.

Lift the bar located under the front of the seat to unlock it. Slide the seat to where you want it and release the bar. Try to move the seat with your body to be sure the seat is locked in place.

Driver Seat Height Adjuster



If your vehicle has this feature, the driver's seat height adjuster is located on the outside of the seat.

Pull lever up to raise or lower seat to a comfortable height.

Six-Way Power Driver Seat



If your vehicle has this feature, the control is located on the outboard side of the driver's seat. To adjust the seat do any of the following:

- Move the seat forward or rearward by pressing the center switch forward or rearward.
- Move the entire seat up or down by pressing the DOWN/UP switch.
- Adjust the seatback by pressing the RECLINE switch forward or rearward.

See *Reclining Seatbacks* on page 1-5, later in this section, for more information.

Manual Lumbar



If your vehicle has this feature, the knob is located on the inboard side of the driver's seatback.

Turn the knob forward or rearward to increase or decrease the lumbar support.

Heated Seats



If your vehicle has this feature, the thumbwheel controls for both driver and passenger heated seats are located in the center of the instrument panel.

Move the thumbwheel to the first circle to warm the seat to a lower temperature and to the second circle for a higher temperature. An indicator light tells you that the heating system is on. This feature will only work when the ignition is on.

Reclining Seatbacks



To adjust the seatback on a manual seat, lift the lever on the outer side of the seat and move the seatback to where you want it. Then release the lever to lock the seatback in place.



On a power driver's seat, adjust the seatback by pressing the RECLINE switch forward or rearward.



But don't have a seatback reclined if your vehicle is moving.

CAUTION:

Sitting in a reclined position when your vehicle is in motion can be dangerous. Even if you buckle up, your safety belts can not do their job when you are reclined like this.

The shoulder belt can not do its job because it will not be against your body. Instead, it will be in front of you. In a crash you could go into it, receiving neck or other injuries.

The lap belt can not do its job either. In a crash the belt could go up over your abdomen. The belt forces would be there, not at your pelvic bones. This could cause serious internal injuries.

For proper protection when the vehicle is in motion, have the seatback upright. Then sit well back in the seat and wear your safety belt properly.

Head Restraints



Your vehicle has adjustable head restraints on the front seats. Slide an adjustable head restraint up or down so that the top of the restraint is closest to the top of your head. This position reduces the chance of neck injury in a crash.

The adjustable head restraints tilt forward and rearward also.

Rear Seats

Split Folding Rear Seat

Your vehicle is equipped with a split folding rear seat. A split folding rear seat enables you to carry long cargo by folding down part or all of the rear seat.

Sedan



On sedans, you can fold either the driver's or passenger's right side of the seatback separately or both sides together. Lift the lever on the corner of the seatback.

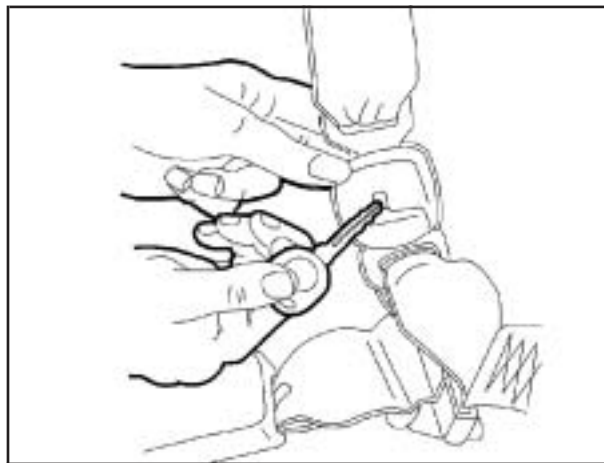

If your vehicle is equipped with this feature, remove the rear center lap-shoulder belt latch. Push the release button up into the slot with a key to remove the lap-shoulder belt latch.

Make sure the front seat is not reclined. If it is, the rear seatback won't fold down all the way.

⚠ CAUTION:

A safety belt that is improperly routed, not properly attached, or twisted will not provide the protection needed in a crash. The person wearing the belt could be seriously injured. After raising the rear seatback, always check to be sure that the safety belts are properly routed and attached, and are not twisted.

⚠ CAUTION:

If the seatback is not locked, it could move forward in a sudden stop or crash. That could cause injury to the person sitting there. Always press rearward on the seatback to be sure it is locked.

To raise the seatback up, follow these steps:

1. Raise the seatback up and make sure it latches. Push and pull the top of the seatback to ensure that all of the latches are secure.
2. Reconnect the center safety belt latch plate to the buckle.

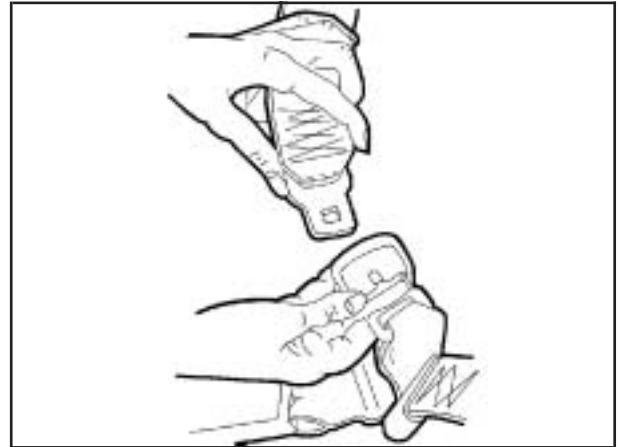

Make sure the safety belt label is pointing to the release button, and that both the safety belt label and release button are facing the front of the vehicle. Make sure the belt is not twisted. Push and pull on the latch plate to ensure the belt is secure.

Wagon

On wagons, you can fold either the passenger's side of the seatback or the entire seatback.



To fold down the passenger's side of the seatback, pull the lever on the corner of the seatback. To lower the entire rear seatback, pull the lever on the corner of the driver's side seatback.

CAUTION:

If the seatback is not locked, it could move forward in a sudden stop or crash. That could cause injury to the person sitting there. Always press rearward on the seatback to be sure it is locked.

When the seatback is put in an upright position, be sure the latches engage by pushing rearward with your hand over the latch locations. Then push and pull at the top of the seatback to ensure that all latches are secure.

Safety Belts

Safety Belts: They Are for Everyone

This part of the manual tells you how to use safety belts properly. It also tells you some things you should not do with safety belts.

CAUTION:

Do not let anyone ride where he or she can not wear a safety belt properly. If you are in a crash and you are not wearing a safety belt, your injuries can be much worse. You can hit things inside the vehicle or be ejected from it. You can be seriously injured or killed. In the same crash, you might not be, if you are buckled up. Always fasten your safety belt, and check that your passengers' belts are fastened properly too.

CAUTION:

It is extremely dangerous to ride in a cargo area, inside or outside of a vehicle. In a collision, people riding in these areas are more likely to be seriously injured or killed. Do not allow people to ride in any area of your vehicle that is not equipped with seats and safety belts. Be sure everyone in your vehicle is in a seat and using a safety belt properly.



Your vehicle has a light that comes on as a reminder to buckle up. See *Safety Belt Reminder Light* on page 3-28.

In most states and in all Canadian provinces, the law says to wear safety belts. Here's why: *They work.*

You never know if you'll be in a crash. If you do have a crash, you don't know if it will be a bad one.

A few crashes are mild, and some crashes can be so serious that even buckled up, a person wouldn't survive. But most crashes are in between. In many of them, people who buckle up can survive and sometimes walk away. Without belts they could have been badly hurt or killed.

After more than 30 years of safety belts in vehicles, the facts are clear. In most crashes buckling up does matter... a lot!

Why Safety Belts Work

When you ride in or on anything, you go as fast as it goes.

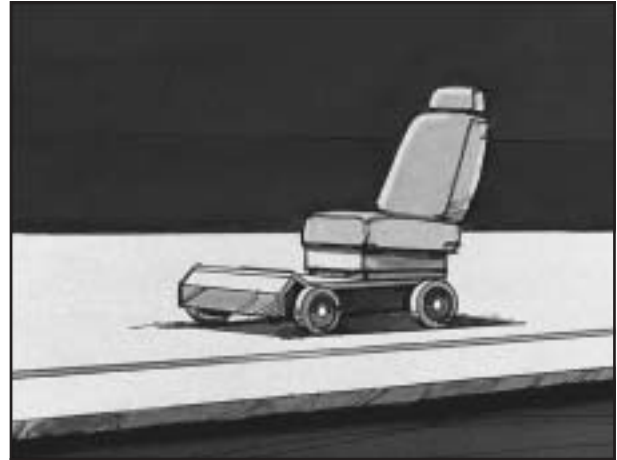

Take the simplest vehicle. Suppose it's just a seat on wheels.



Put someone on it.

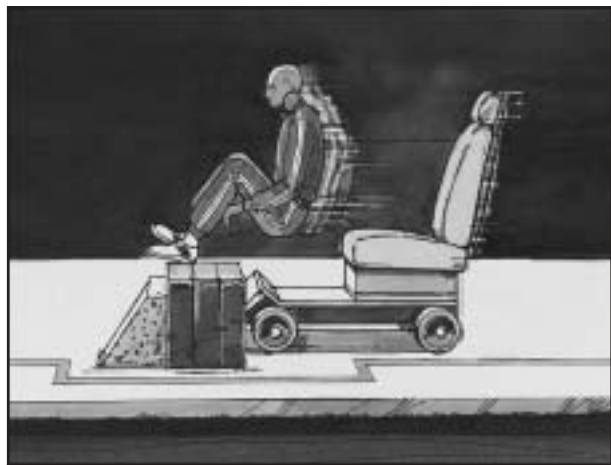

Get it up to speed. Then stop the vehicle. The rider doesn't stop.



The person keeps going until stopped by something. In a real vehicle, it could be the windshield...



or the instrument panel...



or the safety belts!

With safety belts, you slow down as the vehicle does. You get more time to stop. You stop over more distance, and your strongest bones take the forces. That's why safety belts make such good sense.

Questions and Answers About Safety Belts

Q: Won't I be trapped in the vehicle after an accident if I'm wearing a safety belt?

A: You *could* be – whether you're wearing a safety belt or not. But you can unbuckle a safety belt, even if you're upside down. And your chance of being conscious during and after an accident, so you *can* unbuckle and get out, is *much* greater if you are belted.

Q: If my vehicle has air bags, why should I have to wear safety belts?

A: Air bags are in many vehicles today and will be in most of them in the future. But they are supplemental systems only; so they work *with* safety belts – not instead of them. Every air bag system ever offered for sale has required the use of safety belts. Even if you're in a vehicle that has air bags, you still have to buckle up to get the most protection. That's true not only in frontal collisions, but especially in side and other collisions.

Q: If I'm a good driver, and I never drive far from home, why should I wear safety belts?

A: You may be an excellent driver, but if you're in an accident – even one that isn't your fault – you and your passengers can be hurt. Being a good driver doesn't protect you from things beyond your control, such as bad drivers.

Most accidents occur within 25 miles (40 km) of home. And the greatest number of serious injuries and deaths occur at speeds of less than 40 mph (65 km/h).

Safety belts are for everyone.

How to Wear Safety Belts Properly

This part is only for people of adult size.

Be aware that there are special things to know about safety belts and children. And there are different rules for smaller children and babies. If a child will be riding in your vehicle, see *Older Children on page 1-35* or *Infants and Young Children on page 1-38*. Follow those rules for everyone's protection.

First, you'll want to know which restraint systems your vehicle has.

We'll start with the driver position.

Driver Position

This part describes the driver's restraint system.

Lap-Shoulder Belt

The driver has a lap-shoulder belt. Here is how to wear it properly.

1. Close and lock the door.
2. Adjust the seat so you can sit up straight. To see how, see "Seats" in the Index.



3. Pick up the latch plate and pull the belt across you. Do not let it get twisted.
The shoulder belt may lock if you pull the belt across you very quickly. If this happens, let the belt go back slightly to unlock it. Then pull the belt across you more slowly.
4. Push the latch plate into the buckle until it clicks. Pull up on the latch plate to make sure it is secure.
Make sure the release button on the buckle is positioned so you would be able to unbuckle the safety belt quickly if you ever had to. If the belt is not long enough, see *Safety Belt Extender on page 1-35*



5. To make the lap part tight, pull down on the buckle end of the belt as you pull up on the shoulder belt.

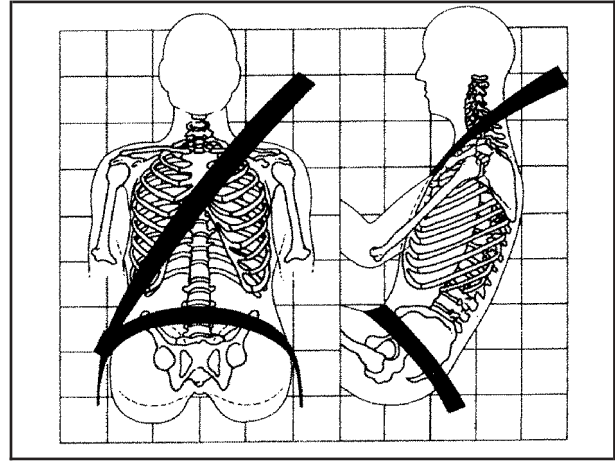

The lap part of the belt should be worn low and snug on the hips, just touching the thighs. In a crash, this applies force to the strong pelvic bones. And you would be less likely to slide under the lap belt. If you slid under it, the belt would apply force at your abdomen. This could cause serious or even fatal injuries. The shoulder belt should go over the shoulder and across the chest. These parts of the body are best able to take belt restraining forces.

The safety belt locks if there is a sudden stop or crash, or if you pull the belt very quickly out of the retractor.

Shoulder Belt Height Adjuster



Before you begin to drive, move the shoulder belt adjuster to the height that is right for you.

To move it down, press down on the indented part of the height adjuster and move the height adjuster to the desired position. You can move the adjuster up just by pushing up on the bottom of the height adjuster. After you move the adjuster to where you want it, try to move it down without pressing down on the indented part to make sure it has locked into position.

Adjust the height so that the shoulder portion of the belt is centered on your shoulder. The belt should be away from your face and neck, but not falling off your shoulder.

Q: What's wrong with this?

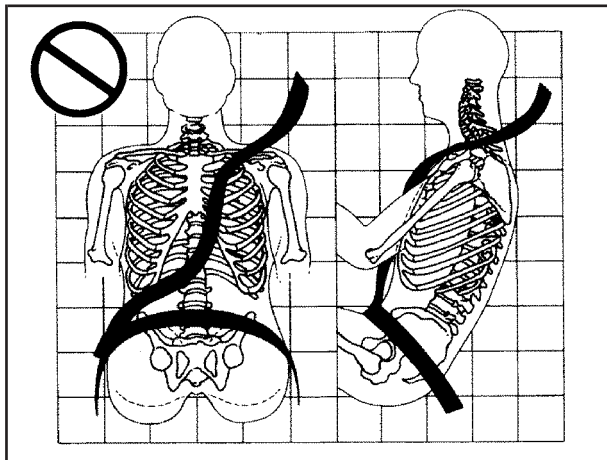

A: The shoulder belt is too loose. It will not give nearly as much protection this way.

⚠ CAUTION:

You can be seriously hurt if your shoulder belt is too loose. In a crash, you would move forward too much, which could increase injury. The shoulder belt should fit against your body.

Q: What's wrong with this?

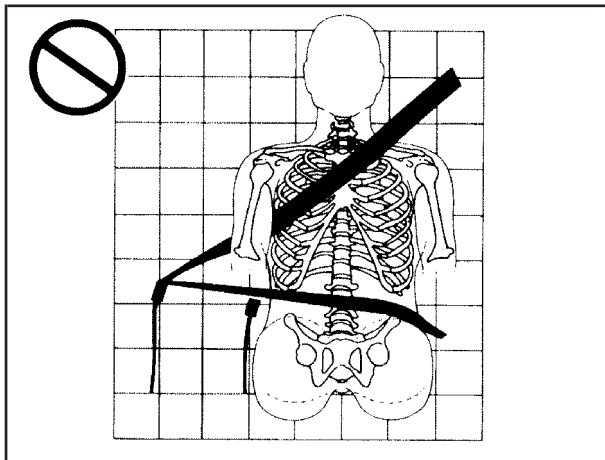

A: The belt is buckled in the wrong place.

⚠ CAUTION:

You can be seriously injured if your belt is buckled in the wrong place like this. In a crash, the belt would go up over your abdomen. The belt forces would be there, not at the pelvic bones. This could cause serious internal injuries. Always buckle your belt into the buckle nearest you.

Q: What's wrong with this?

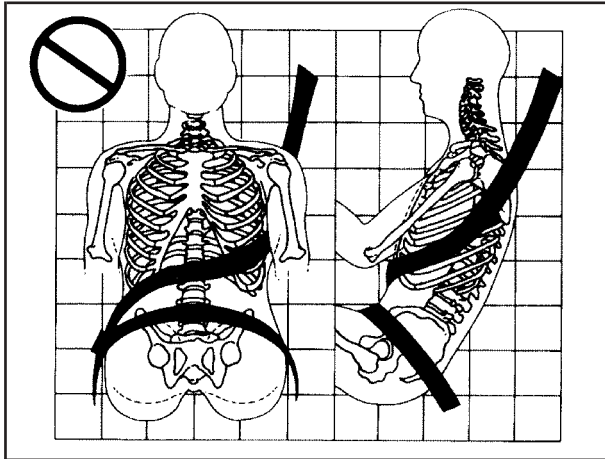

A: The shoulder belt is worn under the arm. It should be worn over the shoulder at all times.

⚠ CAUTION:

You can be seriously injured if you wear the shoulder belt under your arm. In a crash, your body would move too far forward, which would increase the chance of head and neck injury. Also, the belt would apply too much force to the ribs, which are not as strong as shoulder bones. You could also severely injure internal organs like your liver or spleen.

Q: What's wrong with this?

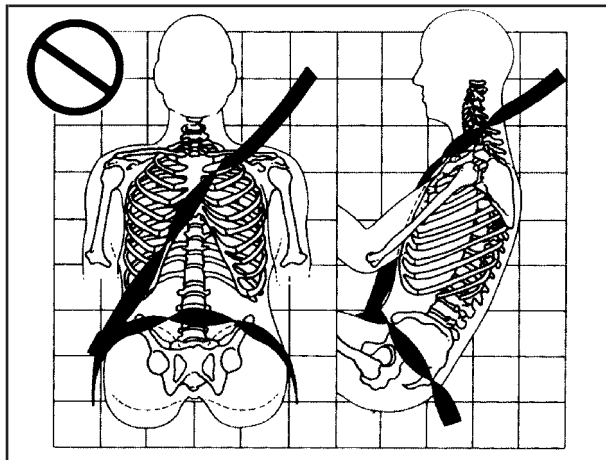

A: The belt is twisted across the body.

⚠ CAUTION:

You can be seriously injured by a twisted belt. In a crash, you wouldn't have the full width of the belt to spread impact forces. If a belt is twisted, make it straight so it can work properly, or ask your retailer to fix it.



To unlatch the belt, just push the button on the buckle. The belt should go back out of the way.

Before you close the door, be sure the belt is out of the way. If you slam the door on it, you can damage both the belt and your vehicle.

Safety Belt Use During Pregnancy

Safety belts work for everyone, including pregnant women. Like all occupants, they are more likely to be seriously injured if they don't wear safety belts.

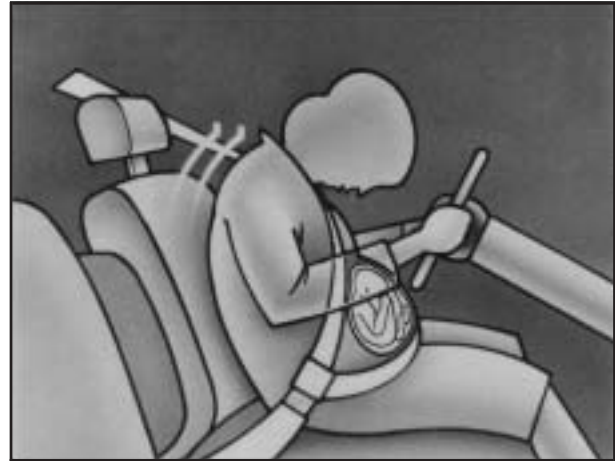

A pregnant woman should wear a lap-shoulder belt, and the lap portion should be worn as low as possible, below the rounding, throughout the pregnancy.

The best way to protect the fetus is to protect the mother. When a safety belt is worn properly, it's more likely that the fetus won't be hurt in a crash. For pregnant women, as for anyone, the key to making safety belts effective is wearing them properly.

Right Front Passenger Position

To learn how to wear the right front passenger's safety belt properly, see *Driver Position on page 1-16*.

The right front passenger's safety belt works the same way as the driver's safety belt – except for one thing. If you ever pull the shoulder portion of the belt out all the way, you will engage the child restraint locking feature. If this happens, just let the belt go back all the way and start again.

Rear Seat Passengers

It is very important for rear seat passengers to buckle up! Accident statistics show that unbelted people in the rear seat are hurt more often in crashes than those who are wearing safety belts.

Rear passengers who are not safety belted can be thrown out of the vehicle in a crash. And they can strike others in the vehicle who are wearing safety belts.

Rear Seat Passenger Positions (Sedan)

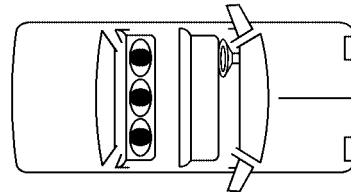

Lap-Shoulder Belt

All rear seating positions have lap-shoulder belts. Here is how to wear one properly.



1. Pick up the latch plate and pull the belt across you. Do not let it get twisted.

The shoulder belt may lock if you pull the belt across you very quickly. If this happens, let the belt go back slightly to unlock it. Then pull the belt across you more slowly.

2. Push the latch plate into the buckle until it clicks. Pull up on the latch plate to make sure it is secure.

When the shoulder belt is pulled out all the way, it will lock. If it does, let it go back all the way and start again.

Make sure the release button on the buckle is positioned so you would be able to unbuckle the safety belt quickly if you ever had to.



3. To make the lap part tight, pull down on the buckle end of the belt as you pull up on the shoulder part.

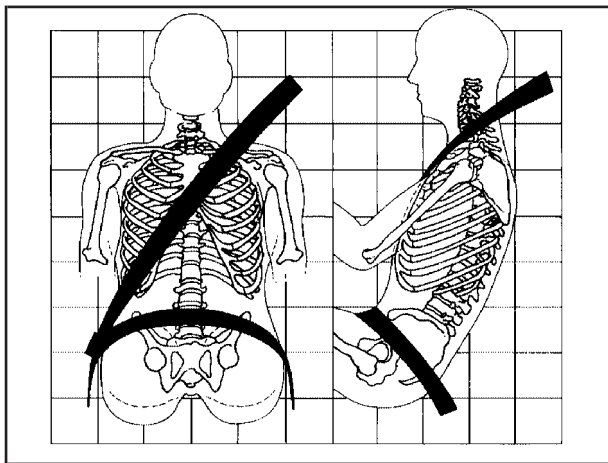

The lap part of the belt should be worn low and snug on the hips, just touching the thighs. In a crash this applies force to the strong pelvic bones.

And you would be less likely to slide under the lap belt. If you slid under it, the belt would apply force at your abdomen. This could cause serious or even fatal injuries. The shoulder belt should go over the shoulder and across the chest. These parts of the body are best able to take belt restraining forces.

The safety belt locks if there is a sudden stop or a crash, or if you pull the belt very quickly out of the retractor.

⚠ CAUTION:

You can be seriously hurt if your shoulder belt is too loose. In a crash, you would move forward too much, which could increase injury. The shoulder belt should fit against your body.



Rear Seat Outside Passenger Positions (Wagon)

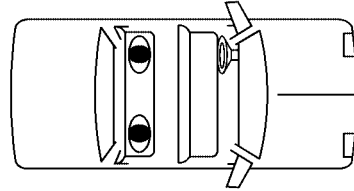

To unlatch the belt, just push the button on the buckle.

Lap-Shoulder Belt

The positions next to the windows have lap-shoulder belts. Here is how to wear one properly.



1. Pick up the latch plate and pull the belt across you. Do not let it get twisted.

The shoulder belt may lock if you pull the belt across you very quickly. If this happens, let the belt go back slightly to unlock it. Then pull the belt across you more slowly.

2. Push the latch plate into the buckle until it clicks. Pull up on the latch plate to make sure it is secure.

When the shoulder belt is pulled out all the way, it will lock. If it does, let it go back all the way and start again.

Make sure the release button on the buckle is positioned so you would be able to unbuckle the safety belt quickly if you ever had to.



3. To make the lap part tight, pull down on the buckle end of the belt as you pull up on the shoulder part.

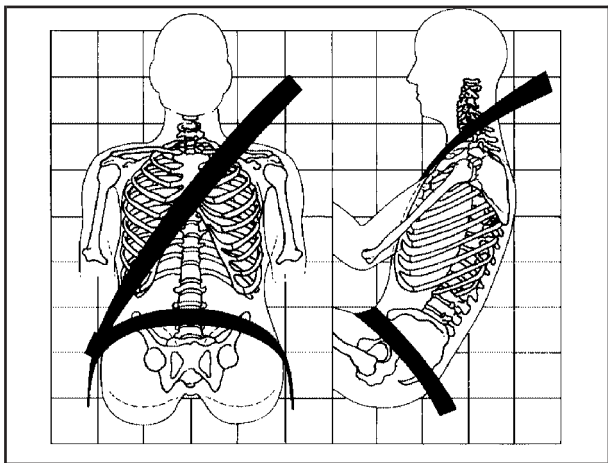

The lap part of the belt should be worn low and snug on the hips, just touching the thighs. In a crash this applies force to the strong pelvic bones.

And you would be less likely to slide under the lap belt. If you slid under it, the belt would apply force at your abdomen. This could cause serious or even fatal injuries. The shoulder belt should go over the shoulder and across the chest. These parts of the body are best able to take belt restraining forces.

The safety belt locks if there is a sudden stop or a crash, or if you pull the belt very quickly out of the retractor.

⚠ CAUTION:

You can be seriously hurt if your shoulder belt is too loose. In a crash, you would move forward too much, which could increase injury. The shoulder belt should fit against your body.



Center Rear Passenger Position (Wagon)

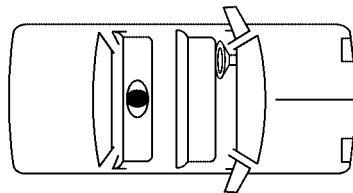

To unlatch the belt, just push the button on the buckle.

Lap Belt

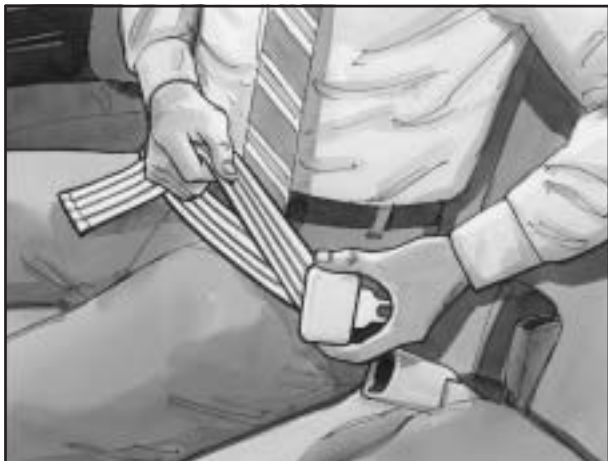

When you sit in the center seating position, you have a lap safety belt, which has no retractor. To make the belt longer, tilt the latch plate and pull it along the belt.



To make the belt shorter, pull its free end as shown until the belt is snug.

Buckle, position and release is the same way as the lap part of a lap-shoulder belt. Make sure the release button on the buckle is positioned so you would be able to unbuckle the safety belt quickly if you ever had to.

Rear Safety Belt Comfort Guides for Children and Small Adults

If you would like to have rear shoulder belt comfort guides installed on your vehicle, contact your retailer.

Rear shoulder belt comfort guides will provide added safety belt comfort for older children who have outgrown booster seats and for small adults. When installed on a shoulder belt, the comfort guide better positions the belt away from the neck and head.

There is one guide available for each outside passenger position in the rear seat. To provide added safety belt comfort for children who have outgrown child restraints and booster seats and for smaller adults, the comfort guides may be installed on the shoulder belts. Here is how to install a comfort guide and use the safety belt:



1. Pull the elastic cord out from between the edge of the seatback and the interior body to remove the guide from its storage clip.



2. Slide the guide under and past the belt. The elastic cord must be under the belt. Then, place the guide over the belt, and insert the two edges of the belt into the slots of the guide.
3. Be sure that the belt is not twisted and it lies flat. The elastic cord must be under the belt and the guide on top.

4. Buckle, position and release the safety belt as described in *Rear Seat Passengers on page 1-25*. Make sure that the shoulder belt crosses the shoulder.

To remove and store the comfort guides, squeeze the belt edges together so that you can take them out of the guides. Pull the guide upward to expose its storage clip, and then slide the guide onto the clip. Turn the guide and clip inward and slide them in between the seatback and the interior body, leaving only the loop of elastic cord exposed.

Safety Belt Extender

If the vehicle's safety belt will fasten around you, you should use it.

But if a safety belt is not long enough to fasten, your retailer will order you an extender. When you go in to order it, take the heaviest coat you will wear, so the extender will be long enough for you. The extender will be just for you, and just for the seat in your vehicle that you choose. Do not let someone else use it, and use it only for the seat it is made to fit. To wear it, just attach it to the regular safety belt.

Child Restraints

Older Children



Older children who have outgrown booster seats should wear the vehicle's safety belts. If you have the choice, a child should sit next to a window so the child can wear a lap-shoulder belt and get the additional restraint a shoulder belt can provide.

Q: What is the proper way to wear safety belts?

A: If possible, an older child should wear a lap-shoulder belt and get the additional restraint a shoulder belt can provide. The shoulder belt should not cross the face or neck. The lap belt should fit snugly below the hips, just touching the top of the thighs. It should never be worn over the abdomen, which could cause severe or even fatal internal injuries in a crash.

Accident statistics show that children are safer if they are restrained in the rear seat.

In a crash, children who are not buckled up can strike other people who are buckled up, or can be thrown out of the vehicle. Older children need to use safety belts properly.



 **CAUTION:**

Never do this.

Here two children are wearing the same belt. The belt can not properly spread the impact forces. In a crash, the two children can be crushed together and seriously injured. A belt must be used by only one person at a time.

Q: What if a child is wearing a lap-shoulder belt, but the child is so small that the shoulder belt is very close to the child's face or neck?

A: For **Sedan Models:** If the child is sitting in a seat next to a window, move the child toward the center of the vehicle. If the child is sitting in the center rear seat passenger position, move the child toward the safety belt buckle. In either case, be sure that the shoulder belt still is on the child's shoulder, so that in a crash the child's upper body would have the restraint that belts provide.

For **Wagon Models:** Move the child toward the center of the vehicle, but be sure that the shoulder belt still is on the child's shoulder, so that in a crash the child's upper body would have the restraint that belts provide. If the child is sitting in a rear seat outside position, see *Rear Safety Belt Comfort Guides for Children and Small Adults* on page 1-33. If the child is so small that the shoulder belt is still very close to the child's face or neck, you might want to place the child in the center seat position, the one that has only a lap belt.



⚠ CAUTION:

Never do this.

Here a child is sitting in a seat that has a lap-shoulder belt, but the shoulder part is behind the child. If the child wears the belt in this way, in a crash the child might slide under the belt. The belt's force would then be applied right on the child's abdomen. That could cause serious or fatal injuries.

Wherever the child sits, the lap portion of the belt should be worn low and snug on the hips, just touching the child's thighs. This applies belt force to the child's pelvic bones in a crash.

Infants and Young Children

Everyone in a vehicle needs protection! This includes infants and all other children. Neither the distance traveled nor the age and size of the traveler changes the need, for everyone, to use safety restraints. In fact, the law in every state in the United States and in every Canadian province says children up to some age must be restrained while in a vehicle.

Every time infants and young children ride in vehicles, they should have the protection provided by appropriate restraints. Young children should not use the vehicle's adult safety belts alone, unless there is no other choice. Instead, they need to use a child restraint.



⚠ CAUTION:

People should never hold a baby in their arms while riding in a vehicle. A baby does not weigh much -- until a crash. During a crash a baby will become so heavy it is not possible to hold it. For example, in a crash at only 25 mph (40 km/h), a 12-lb. (5.5 kg) baby will suddenly become a 240-lb. (110 kg) force on a person's arms. A baby should be secured in an appropriate restraint.



⚠ CAUTION:

Children who are up against, or very close to, any air bag when it inflates can be seriously injured or killed. Air bags plus lap-shoulder belts offer outstanding protection for adults and older children, but not for young children and infants. Neither the vehicle's safety belt system nor its air bag system is designed for them. Young children and infants need the protection that a child restraint system can provide.

Q: What are the different types of add-on child restraints?

A: Add-on child restraints, which are purchased by the vehicle's owner, are available in four basic types. Selection of a particular restraint should take into consideration not only the child's weight, height and age but also whether or not the restraint will be compatible with the motor vehicle in which it will be used.

For most basic types of child restraints, there are many different models available. When purchasing a child restraint, be sure it is designed to be used in a motor vehicle. If it is, the restraint will have a label saying that it meets federal motor vehicle safety standards.

The restraint manufacturer's instructions that come with the restraint, state the weight and height limitations for a particular child restraint. In addition, there are many kinds of restraints available for children with special needs.

 **CAUTION:**

Newborn infants need complete support, including support for the head and neck. This is necessary because a newborn infant's neck is weak and its head weighs so much compared with the rest of its body. In a crash, an infant in a rear-facing seat settles into the restraint, so the crash forces can be distributed across the strongest part of an infant's body, the back and shoulders. Infants always should be secured in appropriate infant restraints.

 **CAUTION:**

The body structure of a young child is quite unlike that of an adult or older child, for whom the safety belts are designed. A young child's hip bones are still so small that the vehicle's regular safety belt may not remain low on the hip bones, as it should. Instead, it may settle up around the child's abdomen. In a crash, the belt would apply force on a body area that is unprotected by any bony structure. This alone could cause serious or fatal injuries. Young children always should be secured in appropriate child restraints.

Child Restraint Systems

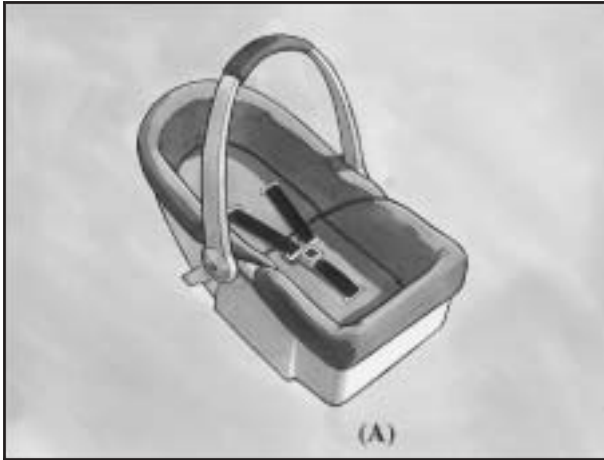

An infant car bed (A), a special bed made for use in a motor vehicle, is an infant restraint system designed to restrain or position a child on a continuous flat surface. Make sure that the infant's head rests toward the center of the vehicle.

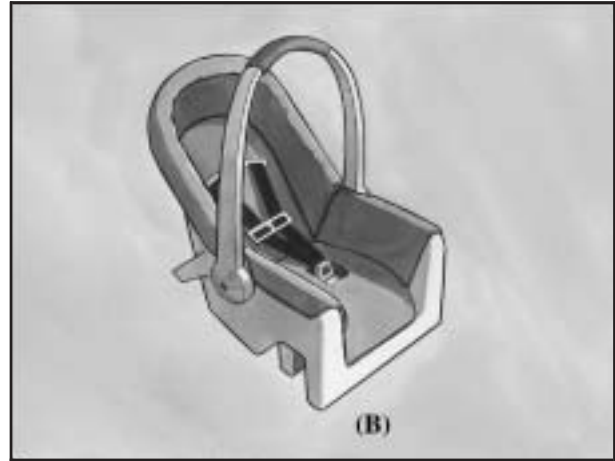

A rear-facing infant seat (B) provides restraint with the seating surface against the back of the infant. The harness system holds the infant in place and, in a crash, acts to keep the infant positioned in the restraint.

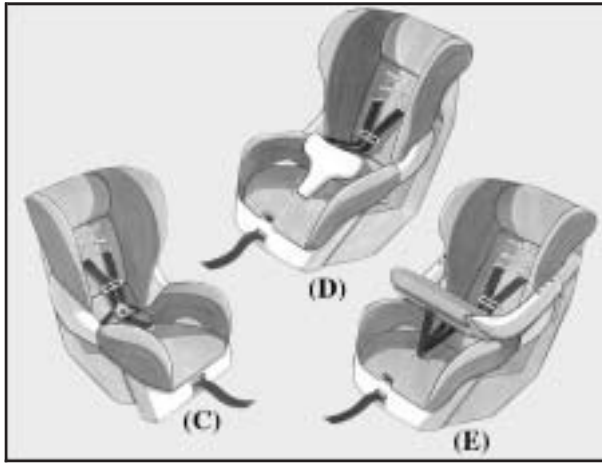

A forward-facing child seat (C-E) provides restraint for the child's body with the harness and also sometimes with surfaces such as T-shaped or shelf-like shields.

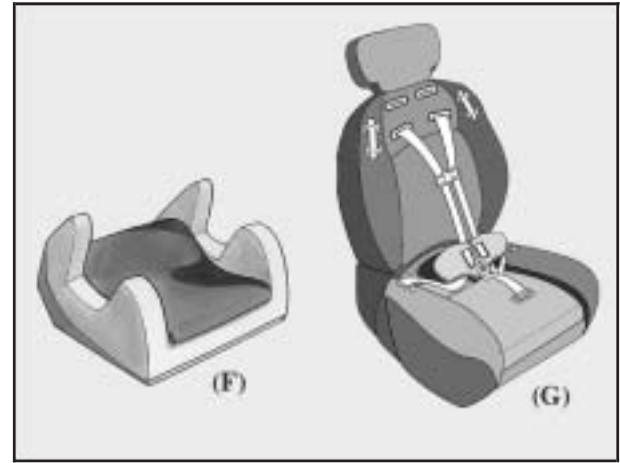

A booster seat (F-G) is a child restraint designed to improve the fit of the vehicle's safety belt system. Some booster seats have a shoulder belt positioner, and some high-back booster seats have a five-point harness. A booster seat can also help a child to see out the window.

Q: How do child restraints work?

A: A child restraint system is any device designed for use in a motor vehicle to restrain, seat, or position children. A built-in child restraint system is a permanent part of the motor vehicle. An add-on child restraint system is a portable one, which is purchased by the vehicle's owner.

For many years, add-on child restraints have used the adult belt system in the vehicle. To help reduce the chance of injury, the child also has to be secured within the restraint. The vehicle's belt system secures the add-on child restraint in the vehicle, and the add-on child restraint's harness system holds the child in place within the restraint.

One system, the three-point harness, has straps that come down over each of the infant's shoulders and buckle together at the crotch. The five-point harness system has two shoulder straps, two hip straps and a crotch strap. A shield may take the place of hip straps. A T-shaped shield has shoulder straps that are attached to a flat pad which rests low against the child's body. A shelf- or armrest-type shield has straps that are attached to a wide, shelf-like shield that swings up or to the side.

When choosing a child restraint, be sure the child restraint is designed to be used in a vehicle. If it is, it will have a label saying that it meets federal motor vehicle safety standards.

Then follow the instructions for the restraint. You may find these instructions on the restraint itself or in a booklet, or both. These restraints use the belt system or the LATCH system in your vehicle, but the child also has to be secured within the restraint to help reduce the chance of personal injury. When securing an add-on child restraint, refer to the instructions that come with the restraint which may be on the restraint itself or in a booklet, or both, and to this manual. The child restraint instructions are important, so if they are not available, obtain a replacement copy from the manufacturer.

Where to Put the Restraint

Accident statistics show that children are safer if they are restrained in the rear rather than the front seat. We, therefore, recommend that child restraints be secured in a rear seat, including an infant riding in a rear-facing infant seat, a child riding in a forward-facing child seat and an older child riding in a booster seat. *Never* put a rear-facing child restraint in the front passenger seat.

Here is why:

 **CAUTION:**

A child in a rear-facing child restraint can be seriously injured or killed if the right front passenger's air bag inflates. This is because the back of the rear-facing child restraint would be very close to the inflating air bag. Always secure a rear-facing child restraint in a rear seat.

If you secure a forward-facing child restraint in the right front seat, always move the front passenger seat as far back as it will go. It is better to secure the child restraint in a rear seat.

 **CAUTION:**

A child in a child restraint in the center front seat can be badly injured or killed by the right front passenger's air bag if it inflates. Never secure a child restraint in the center front seat. It is always better to secure a child restraint in the rear seat.

If you secure a forward-facing child restraint in the right front passenger seat, always move the front passenger seat as far back as it will go. It is better to secure the child restraint in a rear seat.

Wherever you install it, be sure to secure the child restraint properly.

Keep in mind that an unsecured child restraint can move around in a collision or sudden stop and injure people in the vehicle. Be sure to properly secure any child restraint in your vehicle – even when no child is in it.

Top Strap

Some child restraints have a top strap, or “top tether.” It can help restrain the child restraint during a collision. For it to work, a top strap must be properly anchored to the vehicle. Some top strap-equipped child restraints are designed for use with or without the top strap being anchored. Others require the top strap always to be anchored. Be sure to read and follow the instructions for your child restraint. If yours requires that the top strap be anchored, don’t use the restraint unless it is anchored properly.

If the child restraint does not have a top strap, one can be obtained, in kit form, for many child restraints. Ask the child restraint manufacturer whether or not a kit is available.

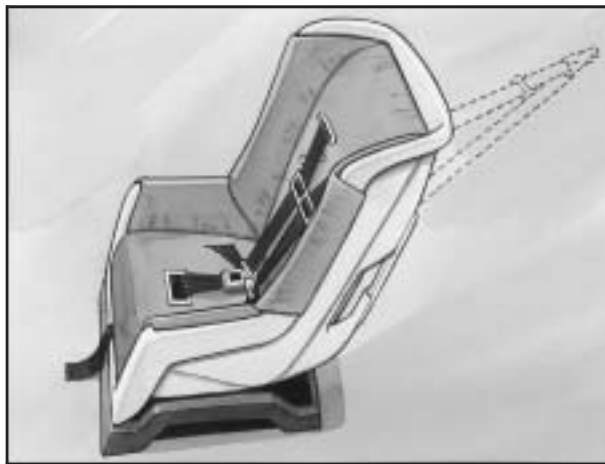

In Canada, the law requires that forward-facing child restraints have a top strap, and that the strap be anchored. In the United States, some child restraints also have a top strap. If your child restraint has a top strap, it should be anchored.

Anchor the top strap to an anchor point specified in *Top Strap Anchor Location* on page 1-47. Be sure to use an anchor point located on the same side of the vehicle as the seating position where the child restraint will be placed.

 **CAUTION:**

Each top tether bracket is designed to anchor only one child restraint. Attaching more than one child restraint to a single bracket could cause the anchor to come loose or even break during a crash. A child or others could be injured if this happens. To help prevent injury to people and damage to your vehicle, attach only one child restraint per bracket.

Once you have the top strap anchored, you'll be ready to secure the child restraint itself. Tighten the top strap when and as the child restraint manufacturer's instructions say.

Top Strap Anchor Location

Your vehicle has top strap anchors installed for the rear seating positions only.

Do not secure a child restraint with a top strap in the right front passenger's position if a national or local law requires that the top strap be anchored, or if the instructions that come with the child restraint say that the top strap must be anchored. There is no place to anchor the top strap in this position.

Sedan



The anchors are located behind the rear seat on the filler panel. In order to get to one of these brackets, you will have to open the trim cover. The trim cover is marked with the symbol for child seat top tether anchor.

Wagon

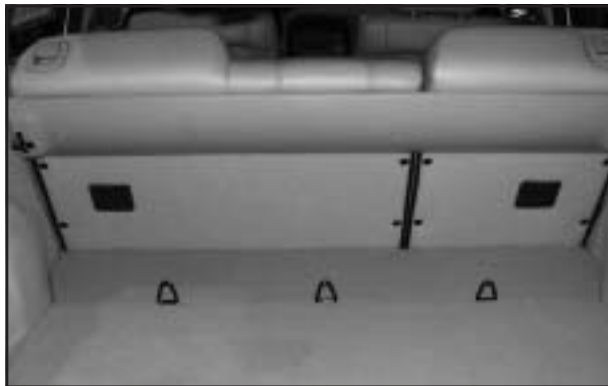

Anchor brackets are located on the floor in the cargo area.

 **CAUTION:**

Routing the top strap for a child restraint over or under the cargo shade could cause the shade to come loose and even break. If this happens, the shade could be thrown about the vehicle in a collision or sudden maneuver. You or others could be injured. When anchoring a top strap to an anchor bracket, be sure to remove the cargo shade from your vehicle. See “Cargo Shade” in the Index.

 **CAUTION:**

Each top tether is designed to anchor only one child restraint. Attaching more than one child restraint to a single bracket could cause the anchor to come loose or even break during a crash. A child or others could be injured if this happens. To help prevent injury to people and damage to your vehicle, attach only one child restraint per bracket.

Lower Anchorages and Top Tethers for Children (LATCH System)

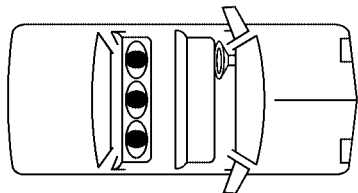

Your vehicle has the LATCH system. You'll find anchors (A) for all three rear seating positions.

This system, designed to make installation of child restraints easier, does not use the vehicle's safety belts. Instead, it uses vehicle anchors (A, B) and child restraint attachments to secure the restraints. Some restraints also use another vehicle anchor to secure a top tether strap (C).

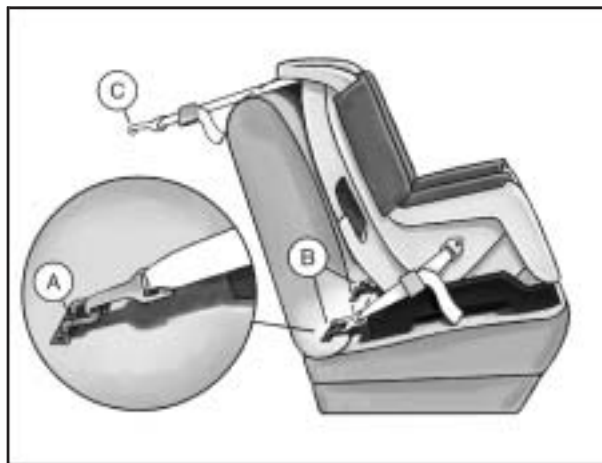

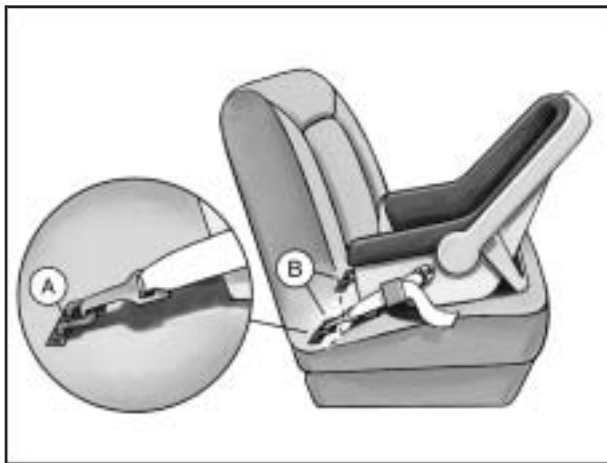

In order to use the LATCH system in your vehicle, you need a child restraint designed for that system.



To assist you in locating the lower anchors for this child restraint system, each seating position with the LATCH system has a label on the seatback at each lower anchor position.

The labels are located near the base of all three rear seating positions.

CAUTION:

If a LATCH-type child restraint is not attached to its anchorage points, the restraint will not be able to protect the child correctly. In a crash, the child could be seriously injured or killed. Make sure that a LATCH-type child restraint is properly installed using the anchorage points, or use the vehicle's safety belts to secure the restraint, following the instructions that came with that restraint, and also the instructions in this manual.

Securing a Child Restraint Designed for the LATCH System

1. Find the LATCH anchorages for the seating position you want to use, where the bottom of the seatback meets the back of the seat cushion. See *Lower Anchorages and Top Tethers for Children (LATCH System)* on page 1-50.
2. Put the child restraint on the seat.
3. Attach and tighten the LATCH attachments on the child restraint to the LATCH anchorages in the vehicle. The child restraint instructions will show you how.
4. If the child restraint is forward-facing, attach and tighten the top tether to the top tether anchorage. The child restraint instructions will show you how. Also see *Top Strap* on page 1-46.
5. Push and pull the child restraint in different directions to be sure it is secure.

To remove the child restraint, simply unhook the top tether from the top tether anchorage and then disconnect the LATCH attachments from the LATCH anchorages.

Securing a Child Restraint in a Rear Seat Position (Sedan)

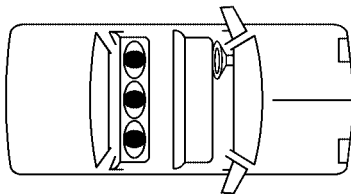

If your child restraint is equipped with the LATCH system, see *Lower Anchorages and Top Tethers for Children (LATCH System)* on page 1-50. See *Top Strap* on page 1-46 if the child restraint has one.

If your child restraint does not have the LATCH system, you will be using the lap-shoulder belt. Be sure to follow the instructions that came with the child restraint. Secure the child in the child restraint when and as the instructions say.

1. Put the restraint on the seat.
2. Pick up the latch plate, and run the lap and shoulder portions of the vehicle's safety belt through or around the restraint. The child restraint instructions will show you how.



3. Buckle the belt. Make sure the release button is positioned so you would be able to unbuckle the safety belt quickly if you ever had to.



4. Pull the rest of shoulder belt all the way out of the retractor to set the lock.



Securing a Child Restraint in a Rear Outside Seat Position (Wagon)

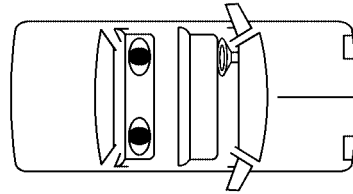

If your child restraint is equipped with the LATCH system, see *Lower Anchorages and Top Tethers for Children (LATCH System)* on page 1-50. See *Top Strap* on page 1-46 if the child restraint has one.

If your child restraint does not have the LATCH system, you will be using the lap-shoulder belt to secure the child restraint in this position. Be sure to follow the instructions that came with the child restraint. Secure the child in the child restraint when and as the instructions say.

5. To tighten the belt, pull up on the shoulder belt while you push down on the child restraint. If you are using a forward-facing child restraint, you may find it helpful to use your knee to push down on the child restraint as you tighten the belt.
6. Push and pull the child restraint in different directions to be sure it is secure.

To remove the child restraint, just unbuckle the vehicle's safety belt and let it go back all the way. The safety belt will move freely again and be ready to work for an adult or larger child passenger.

1. Put the restraint on the seat.
2. Pick up the latch plate, and run the lap and shoulder portions of the vehicle's safety belt through or around the restraint. The child restraint instructions will show you how.



3. Buckle the belt. Make sure the release button is positioned so you would be able to unbuckle the safety belt quickly if you ever had to.



4. Pull the rest of shoulder belt all the way out of the retractor to set the lock.



Securing a Child Restraint in a Center Rear Seat Position (Wagon)

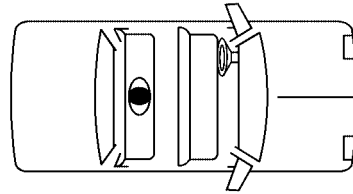

If your child restraint is equipped with the LATCH system, see *Lower Anchorages and Top Tethers for Children (LATCH System)* on page 1-50. See *Top Strap* on page 1-46 if the child restraint has one.

If your child restraint does not have the LATCH system, you will be using the lap belt. Be sure to follow the instructions that came with the child restraint. Secure the child restraint when and as the instructions say.

5. To tighten the belt, pull up on the shoulder belt while you push down on the child restraint. If you are using a forward-facing child restraint, you may find it helpful to use your knee to push down on the child restraint as you tighten the belt.
6. Push and pull the child restraint in different directions to be sure it is secure.

To remove the child restraint, just unbuckle the vehicle's safety belt and let it go back all the way. The safety belt will move freely again and be ready to work for an adult or larger child passenger.



1. Make the belt as long as possible by tilting the latch plate and pulling it along the belt.
2. Put the restraint on the seat.



3. Run the vehicle's safety belt through or around the restraint. The child restraint instructions will show you how.

4. Buckle the belt. Make sure the release button is positioned so you would be able to unbuckle the safety belt quickly if you ever had to.
5. To tighten the belt, pull its free end while you push down on the child restraint. If you are using a forward-facing child restraint, you may find it helpful to use your knee to push the child restraint as you tighten the belt.
6. Push and pull the child restraint in different directions to be sure it is secure.

To remove the child restraint, just unbuckle the vehicle's safety belt. It will be ready to work for an adult or larger child passenger.

Securing a Child Restraint in the Right Front Seat Position

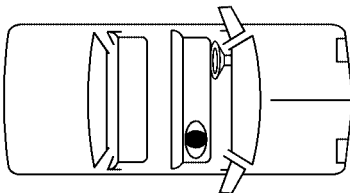

If your child restraint is equipped with the LATCH system, see *Lower Anchorages and Top Tethers for Children (LATCH System)* on page 1-50. See *Top Strap* on page 1-46 if the child restraint has one.

There is no top strap anchor in the right front passenger's position. Do not secure a child seat in this position if a national or local law requires that the top strap be anchored, or if the instructions that come with the child restraint say that the top strap must be anchored.

Your vehicle has a right front passenger air bag. *Never* put a rear-facing child restraint in this seat. Here is why:

 **CAUTION:**

A child in a rear-facing child restraint can be seriously injured or killed if the right front passenger's air bag inflates. This is because the back of the rear-facing child restraint would be very close to the inflating air bag. Always secure a rear-facing child restraint in a rear seat.

A rear seat is a safer place to secure a forward-facing child restraint. If you need to secure a forward-facing child restraint in the right front seat, you will be using the lap-shoulder belt to secure the child restraint. Be sure to follow the instructions that came with the child restraint. Secure the child in the child restraint when and as the instructions say.

1. Because your vehicle has a right front passenger air bag, always move the seat as far back as it will go before securing a forward-facing child restraint. See *Manual Seats on page 1-3*.
2. Put the child restraint on the seat.
3. Pick up the latch plate, and run the lap and shoulder portions of the vehicle's safety belt through or around the restraint. The child restraint instructions will show you how.



4. Buckle the belt. Make sure the release button is positioned so you would be able to unbuckle the safety belt quickly if you ever had to.



5. Pull the rest of the shoulder belt all the way out of the retractor to set the lock.



6. To tighten the belt, push down on the child restraint, pull the shoulder portion of the belt to tighten the lap portion of the belt and feed the shoulder belt back into the retractor. You may find it helpful to use your knee to push down on the child restraint as you tighten the belt.
7. Push and pull the child restraint in different directions to be sure it is secure.

To remove the child restraint, just unbuckle the vehicle's safety belt and let it go back all the way. The safety belt will move freely again and be ready to work for an adult or larger child passenger.

Air Bag Systems

This part explains the frontal and side impact air bag systems.

Your vehicle has four air bags:

- A frontal air bag for the driver and another frontal air bag for the right front passenger,
- A roof-mounted side impact air bag for the driver and passenger directly behind the driver, and
- A roof-mounted side impact air bag for the right front passenger and the person seated directly behind that passenger.

Frontal air bags are designed to help reduce the risk of injury from the force of an inflating air bag. But these air bags must inflate very quickly to do their job and comply with federal regulations.

Here are the most important things to know about the air bag systems:

CAUTION:

You can be severely injured or killed in a crash if you are not wearing your safety belt – even if you have air bags. Wearing your safety belt during a crash helps reduce your chance of hitting things inside the vehicle or being ejected from it. Air bags are designed to work with safety belts but do not replace them.

Frontal air bags for the driver and right front passenger are designed to deploy only in moderate to severe frontal and near frontal crashes. They are not designed to inflate in rollover, rear or low-speed frontal crashes, or in many side crashes. And, for some unrestrained occupants, frontal air bags may provide less protection in frontal crashes than more forceful air bags have provided in the past.

The side impact air bags are designed to inflate only in moderate to severe crashes where something hits the side of your vehicle.

CAUTION: (Continued)

CAUTION: (Continued)

They are not designed to inflate in frontal, in rollover or in rear crashes.

Everyone in your vehicle should wear a safety belt properly – whether or not there is an air bag for that person.

 **CAUTION:**

Both frontal and side impact air bags inflate with great force, faster than the blink of an eye. If you're too close to an inflating air bag, as you would be if you were leaning forward, it could seriously injure you. Safety belts help keep you in position for air bag inflation before and during a crash. Always wear your safety belt even with frontal air bags. The driver should sit as far back as possible while still maintaining control of the vehicle. Occupants should not lean on or sleep against the door.

 **CAUTION:**

Anyone who is up against, or very close to, any air bag when it inflates can be seriously injured or killed. Air bags plus lap-shoulder belts offer the best protection for adults, but not for young children and infants. Neither the vehicle's safety belt system nor its air bag system is designed for them. Young children and infants need the protection that a child restraint system can provide. Always secure children properly in your vehicle. To read how, see the part of this manual called "Older Children" or "Infants and Young Children."



There is a air bag readiness light on the instrument panel, which shows the air bag symbol.

The system checks the air bag electrical system for malfunctions. The light tells you if there is an electrical problem. See *Air Bag Readiness Light* on page 3-28 for more information.

Where Are the Air Bags?



The driver's frontal air bag is in the middle of the steering wheel.



The right front passenger's frontal air bag is in the instrument panel on the passenger's side.



If your vehicle has a side impact air bag for the driver and the person seated directly behind the driver, it is in the ceiling above the side windows.



If your vehicle has a side impact air bag for the right front passenger and the person seated directly behind that passenger, it is in the ceiling above the side windows.

CAUTION:

If something is between an occupant and an air bag, the bag might not inflate properly or it might force the object into that person causing severe injury or even death. The path of an inflating air bag must be kept clear. Don't put anything between an occupant and an air bag, and don't attach or put anything on the steering wheel hub or on or near any other air bag covering. And, because your vehicle has side impact air bags, never secure anything to the roof of your vehicle by routing the rope or tiedown through any door or window opening. If you do, the path of an inflating side impact air bag will be blocked. The path of an inflating air bag must be kept clear.

When Should an Air Bag Inflate?

The driver's and right front passenger's frontal air bags are designed to inflate in moderate to severe frontal or near-frontal crashes. But they are designed to inflate only if the impact speed is above the system's designed "threshold level."

If the front of your vehicle goes straight into a wall that does not move or deform, the threshold level is about 9 to 15 mph (14 to 24 km/h). The threshold level can vary, however, with specific vehicle design, so that it can be somewhat above or below this range. If your vehicle strikes something that will move or deform, such as a parked car, the threshold level will be higher.

The driver's and right front passenger's frontal air bags are not designed to inflate in rollovers, rear impacts, or in many side impacts because inflation would not help the occupant.

Side impact air bags are designed to inflate in moderate to severe side crashes. A side impact air bag will inflate if the crash severity is above the system's designed "threshold level." The threshold level can vary with specific vehicle design. Side impact air bags are not designed to inflate in frontal or near-frontal impacts, rollovers or rear impacts, because inflation would not help the occupant. A side impact air bag will only deploy on the side of the vehicle that is struck.

In any particular crash, no one can say whether an air bag should have inflated simply because of the damage to a vehicle or because of what the repair costs were. For frontal air bags, inflation is determined by the angle of the impact and how quickly the vehicle slows down in frontal and near-frontal impacts. For side impact air bags, inflation is determined by the location and severity of the impact.

What Makes an Air Bag Inflate?

In an impact of sufficient severity, the air bag sensing system detects that the vehicle is in a crash. For both frontal and side impact air bags, the sensing system triggers a release of gas from the inflator, which inflates the air bag. The inflator, air bag, and related hardware are all part of the air bag modules inside the steering wheel and in the instrument panel in front of the right front passenger. For vehicles with side impact air bags, the air bag modules are located in the ceiling of the vehicle, near the side windows.

How Does an Air Bag Restrain?

In moderate to severe frontal or near frontal collisions, even belted occupants can contact the steering wheel or the instrument panel. In moderate to severe side collisions, even belted occupants can contact the inside of the vehicle. The air bag supplements the protection provided by safety belts. Air bags distribute the force of the impact more evenly over the occupant's upper body, stopping the occupant more gradually. But the frontal air bags would not help you in many types of collisions, including rollovers, rear impacts, and many side impacts, primarily because an occupant's motion is not toward the air bag. Side impact air bags would not help you in many types of collisions, including frontal or near frontal collisions, rollovers, and rear impacts, primarily because an occupant's motion is not toward those air bags. Air bags should never be regarded as anything more than a supplement to safety belts, and then only in moderate to severe frontal or near-frontal collisions for the driver's and right front passenger's frontal air bags, and only in moderate to severe side collisions for vehicles with a driver's and right front passenger's side impact air bag.

What Will You See After an Air Bag Inflates?

After the air bag inflates, it quickly deflates, so quickly that some people may not even realize the air bag inflated. Some components of the air bag module will be hot for a short time. These components include the steering wheel hub for the driver's frontal air bag and the instrument panel for the right front passenger's frontal air bag. For vehicles with side impact air bags, the ceiling of your vehicle near the side windows will be hot. The parts of the bag that come into contact with you may be warm, but not too hot to touch. There will be some smoke and dust coming from the vents in the deflated air bags. Air bag inflation does not prevent the driver from seeing or being able to steer the vehicle, nor does it stop people from leaving the vehicle.

CAUTION:

When an air bag inflates, there is dust in the air. This dust could cause breathing problems for people with a history of asthma or other breathing trouble. To avoid this, everyone in the vehicle should get out as soon as it is safe to do so. If you have breathing problems but can not get out of the vehicle after an air bag inflates, then get fresh air by opening a window or a door. If you experience breathing problems following an air bag deployment, you should seek medical attention.

Your vehicle has a feature that will automatically unlock the doors and turn the interior dome lamp on and flash the daytime running lights on and off when the air bags inflate (if battery power is available). You can lock the doors again and turn the interior lamps off by using the door lock and interior lamp controls.

You must first turn your ignition key to the following ignition switch positions:

1. Turn the ignition key to the OFF position.
2. Turn the ignition key to the RUN position.
3. Turn the ignition key to the OFF position.

In many crashes severe enough to inflate an air bag, windshields are broken by vehicle deformation. Additional windshield breakage may also occur from the right front passenger air bag.

- Air bags are designed to inflate only once. After an air bag inflates, you will need some new parts for your air bag system. If you do not get them, the air bag system will not be there to help protect you in another crash. A new system will include air bag modules and possibly other parts. The service manual for your vehicle covers the need to replace other parts.

- Your vehicle is equipped with a crash sensing and diagnostic module, which records information about the air bag system. The module records information about the readiness of the system, when the system commands air bag inflation and driver's safety belt usage at deployment.
- Let only qualified technicians work on your air bag system. Improper service can mean that your air bag system will not work properly. See your retailer for service.

Notice: If you damage the covering for the driver's or the right front passenger's air bag, or the side impact air bag covering on the ceiling near the side windows, the bag may not work properly. You may have to replace the air bag module in the steering wheel, both the air bag module and the instrument panel for the right front passenger's air bag, or side impact air bag module and ceiling covering for the roof-mounted side impact air bag. Do not open or break the air bag coverings.

Servicing Your Air Bag-Equipped Vehicle

Air bags affect how your vehicle should be serviced. There are air bag system parts in several places around your vehicle. You don't want the system to inflate while someone is working on your vehicle. Your retailer and the Saturn Service Manual have information about servicing your vehicle and the air bag systems. To purchase a service manual, see *Service Publications Ordering Information on page 7-10*.

CAUTION:

For up to one minute after the ignition key is turned off and the battery is disconnected, an air bag can still inflate during improper service. You can be injured if you are close to an air bag when it inflates. Avoid wires wrapped with yellow tape, yellow coverings, or yellow connectors. They are probably part of the air bag systems. Be sure to follow proper service procedures, and make sure the person performing work for you is qualified to do so.

Air bag systems do not need regular maintenance.

Adding Equipment to Your Air Bag-Equipped Vehicle

Q: If I add a luggage carrier or sunroof to the roof of my vehicle, will it keep the roof-mounted side impact air bags from working properly?

A: As long as the luggage carrier or sunroof is properly installed so that the vehicle's basic structure isn't changed, it's not likely to keep the roof-mounted side impact air bags from working properly in a crash.

Restraint System Check

Checking Your Restraint Systems

Now and then, make sure the safety belt reminder light and all your belts, buckles, latch plates, retractors and anchorages are working properly. Look for any other loose or damaged safety belt system parts. If you see anything that might keep a safety belt system from doing its job, have it repaired.

Torn or frayed safety belts may not protect you in a crash. They can rip apart under impact forces. If a belt is torn or frayed, get a new one right away.

Also look for any opened or broken air bag covers, and have them repaired or replaced. (The air bag system does not need regular maintenance.)

Replacing Restraint System Parts After a Crash

CAUTION:

A crash can damage the restraint systems in your vehicle. A damaged restraint system may not properly protect the person using it, resulting in serious injury or even death in a crash. To help make sure your restraint systems are working properly after a crash, have them inspected and any necessary replacements made as soon as possible.

If you've had a crash, do you need new belts or LATCH system parts?

After a very minor collision, nothing may be necessary. But if the belts were stretched, as they would be if worn during a more severe crash, then you need new parts.

If the LATCH system was being used during a more severe crash, you may need new LATCH system parts.

If belts are cut or damaged, replace them. Collision damage also may mean you will need to have LATCH system, safety belt or seat parts repaired or replaced. New parts and repairs may be necessary even if the belt or LATCH system wasn't being used at the time of the collision.

If your seat adjuster won't work after a crash, the special part of the safety belt that goes through the seat to the adjuster may need to be replaced.

If an air bag inflates, you'll need to replace air bag system parts. See the part about the air bag system earlier in this manual.

NOTES

Section 2 Features and Controls

Keys	2-3	Starting Your Engine	2-21
Remote Keyless Entry System	2-4	Engine Coolant Heater	2-22
Remote Keyless Entry System Operation	2-5	Automatic Transaxle Operation	2-23
Doors and Locks	2-9	Parking Brake	2-27
Door Locks	2-9	Shifting Into Park (P) (Automatic Transaxle)	2-28
Power Door Locks	2-10	Shifting Out of Park (P)	2-30
Delayed Locking	2-10	Parking Over Things That Burn	2-30
Programmable Automatic Door Locks	2-11	Engine Exhaust	2-31
Rear Door Security Locks	2-11	Running Your Engine While You Are Parked	2-32
Lockout Protection	2-12	Mirrors	2-33
Leaving Your Vehicle	2-12	Manual Rearview Mirror	2-33
Trunk/Liftgate	2-13	Manual Rearview Mirror with OnStar®	2-33
Windows	2-16	Automatic Dimming Rearview Mirror with OnStar®, Compass and Temperature Display	2-34
Manual Windows	2-17	Automatic Dimming Rearview Mirror with Compass and Temperature Display	2-36
Power Windows	2-17	Outside Remote Control Mirror	2-38
Sun Visors	2-18	Outside Power Mirrors	2-39
Theft-Deterrent Systems	2-18	Outside Convex Mirror	2-39
Passlock®	2-18	Outside Heated Mirrors	2-39
Starting and Operating Your Vehicle	2-19	OnStar® System	2-40
New Vehicle Break-In	2-19		
Ignition Positions	2-20		

Section 2 Features and Controls

Storage Areas	2-41	Load Floor Storage Box	2-42
Glove Box	2-41	Roof Rack System	2-42
Center Console Storage Area	2-41	Cargo Cover	2-43
Assist Handles	2-41	Sunroof	2-45

Keys

CAUTION:

Leaving children in a vehicle with the ignition key is dangerous for many reasons. They could operate the power windows or other controls or even make the vehicle move. The children or others could be badly injured or even killed. Do not leave the keys in a vehicle with children.



One key is used for the ignition and all of the locks.

Key code information can be obtained only at the retailer where your vehicle was purchased. These code numbers can be used to make new keys. Additional keys that are needed can be made at any retail service facility provided you have the key code information. Store this information in a safe place, but not in your vehicle.

Have extra keys made. Your service parts department can make extra keys for you.

Notice: If you ever lock your keys in your vehicle, you may have to damage the vehicle to get in. Be sure you have spare keys.

Remote Keyless Entry System

The remote keyless entry system operates on a radio frequency subject to Federal Communications Commission (FCC) Rules and with Industry Canada.

This device complies with Part 15 of the FCC Rules. Operation is subject to the following two conditions:

1. This device may not cause interference, and
2. This device must accept any interference received, including interference that may cause undesired operation of the device.

This device complies with RSS-210 of Industry Canada. Operation is subject to the following two conditions:

1. This device may not cause interference, and
2. This device must accept any interference received, including interference that may cause undesired operation of the device.

Changes or modifications to this system by other than an authorized service facility could void authorization to use this equipment.

At times you may notice a decrease in range. This is normal for any remote keyless entry system. If the transmitter does not work or if you have to stand closer to your vehicle for the transmitter to work, try this:

- Check the distance. You may be too far from your vehicle. You may need to stand closer during rainy or snowy weather.
- Check the location. Other vehicles or objects may be blocking the signal. Take a few steps to the left or right, hold the transmitter higher, and try again.
- Check to determine if battery replacement or resynchronization is necessary. See “Battery Replacement” and “Resynchronization” under *Remote Keyless Entry System Operation on page 2-5*.
- If you are still having trouble, see your Saturn retailer or authorized service provider for service.

Remote Keyless Entry System Operation

With this feature, you can lock and unlock the doors or the trunk from about 26 feet (8 m) away using the remote keyless entry transmitter supplied with your vehicle.



LOCK: Press this button on the remote keyless entry transmitter to lock the doors. This also arms the theft-deterrent system. See “Theft-Deterrent System” following for information on arming the theft-deterrent system.

Your vehicle can be programmed so that the parking lamps will flash and/or the horn will sound when you lock the doors with the remote keyless entry transmitter. See your retailer for more information on programming this feature.

UNLOCK: Press this button on the remote keyless entry transmitter to unlock the driver's door. This also disarms the theft-deterrent system. See "Theft-Deterrent System" following for information on disarming the theft-deterrent system. Press the button again within 5 seconds to unlock the rest of the doors.

 **(Panic Alarm):** Press the button with the horn symbol when the ignition is turned off. The horn will sound and the parking lamps and dome lamp will flash for up to two minutes. To stop the panic alarm, press this button again.

 **(Trunk):** Press this button to open the trunk or liftgate. The trunk or liftgate will not open when this button is pressed if the vehicle is moving.

Theft-Deterrent System

The remote keyless entry transmitter is used to arm/disarm the theft-deterrent system. Your vehicle's theft-deterrent system can be programmed to three different modes.

Active Arming: The system will arm when the lock button on the remote keyless entry transmitter is pressed. The system will disarm when the unlock button is pressed.

Passive Arming: The system will arm itself one minute after the ignition is turned off and the driver's door has been opened and closed. If the lock button on the transmitter is pressed before the minute has passed, the system will arm immediately. The system will disarm when the unlock button is pressed.

Security System Disable: The system will not arm.

To change the mode that your vehicle is programmed to, do the following:

1. Turn the ignition to RUN or ACC.
2. Press the panic alarm button on the transmitter slowly four times within five seconds.
3. You must complete one of the following within three seconds to change the mode.
 - To select the active arming mode, press the lock button on the transmitter.
 - To select the passive arming mode, press the trunk release button on the transmitter.
 - To select the security system disable mode, press the unlock button on the transmitter.

A chime will sound once the mode has been selected.

If you accidentally set off the alarm when entering/exiting the vehicle, you can shut it off by pressing any button on the remote keyless entry transmitter other than the panic alarm button.

If you hear three horn chirps when you press the unlock button on the transmitter, that means the vehicle's alarm was triggered while you were away.

Matching Transmitter(s) to Your Vehicle

Each remote keyless entry transmitter is coded to prevent another transmitter from unlocking your vehicle. If a transmitter is lost or stolen, a replacement can be purchased through your retailer. Remember to bring any remaining transmitters with you when you go to your retailer. When the retailer matches the replacement transmitter to your vehicle, any remaining transmitters must also be matched. Once your retailer has coded the new transmitter, the lost transmitter will not unlock your vehicle. Each vehicle can have a maximum of four transmitters matched to it.

Battery Replacement

Under normal use, the battery in your remote keyless entry transmitter should last about four years.

You can tell the battery is weak if the transmitter won't work at the normal range in any location. If you have to get close to your vehicle before the transmitter works, it's probably time to change the battery.

Notice: When replacing the battery, use care not to touch any of the circuitry. Static from your body transferred to these surfaces may damage the transmitter.

1. Use a flat thin object to pry open the transmitter.



Resynchronization

This is used to keep the transmitter of the vehicle communicating with the receiver of the vehicle. Resynchronization may be required due to the security method used by this system.

Your vehicle has an automatic resynchronization function built into the system. If your transmitter is not working properly and you have to manually resynchronize, press the lock and unlock buttons at the same time for seven seconds while you are near your vehicle. The doors will lock or unlock, depending on their starting position. If they do not, contact your retailer for service.

2. Once the transmitter is separated, use a pencil or similar object to remove the old battery. Do not use a metal object.
3. Insert the new battery as the instructions under the cover indicate.
4. Snap the transmitter back together tightly to be sure no moisture can enter.
5. Check the operation of the transmitter.

If the transmitter does not work, try synchronizing your transmitter with your receiver. See "Resynchronization" for more information.

Doors and Locks

Door Locks

CAUTION:

Unlocked doors can be dangerous.

- Passengers — especially children — can easily open the doors and fall out of a moving vehicle. When a door is locked, the handle will not open it. You increase the chance of being thrown out of the vehicle in a crash if the doors are not locked. So, wear safety belts properly and lock the doors whenever you drive.
- Young children who get into unlocked vehicles may be unable to get out. A child can be overcome by extreme heat and can suffer permanent injuries or even death from heat stroke. Always lock your vehicle whenever you leave it.
- Outsiders can easily enter through an unlocked door when you slow down or stop your vehicle. Locking your doors can help prevent this from happening.

There are several ways to lock and unlock your vehicle.

From the outside, you can use your door key to lock or unlock a front door.

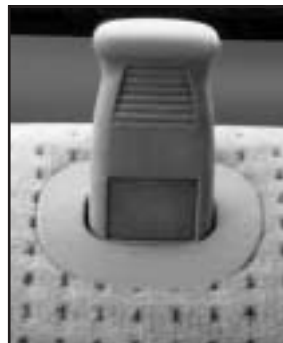

To manually lock or unlock the door from the inside, move the door lock pin on the door down or up. The unlocked door indicator on the door pin will be hidden when the door is locked.

Power Door Locks



Press the bottom half of the switch on either front door to lock all of the doors. Push the top half of the switch to unlock all of the doors. The unlocked door indicators on the manual door lock pins will be hidden when the doors are locked.

Delayed Locking

A chime will sound three times to indicate a door is open when you try to lock the doors with the remote keyless entry transmitter or the power door lock switch. The doors will not lock, and the remote keyless entry system will not arm until all the doors are closed and five seconds have passed.

The delayed locking feature can be overridden by pressing the lock button on the remote keyless entry, or the door lock switch, a second time. The doors will lock immediately and when all doors are closed the remote keyless entry system will arm after 30 seconds.

To get the horn to chirp if a door was open during the arming process, you must press the lock button on your transmitter twice after the doors are closed.

Programmable Automatic Door Locks

With this feature, all the doors will lock as the transaxle is shifted out of PARK (P) if the ignition key is in the RUN position and all doors are closed. The doors will automatically lock if the vehicle is going faster than 3 mph (5 km/h).

In the following two situations, when a door is opened, all doors will lock again:

- The brake pedal is applied, a door is opened and then closed, and the brake pedal is released.
- A door is opened and closed without the brake pedal applied while the vehicle is moving faster than 3 mph (5 km/h).

When programmed, all doors will unlock when the key is removed from the ignition.

The programmable unlocking feature can be programmed on or off by turning the ignition key to RUN and pressing the unlock power door lock switch for eight seconds. The horn will chirp once when this feature is on and will chirp twice when it is off.

Rear Door Security Locks

Your vehicle has rear door security locks that prevent passengers from opening the rear doors from the inside.

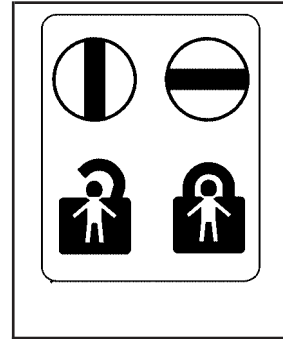

The rear door security locks are located on the inside edge of each rear door. You must open the rear doors to access them.

To set the secondary locks, do the following:

1. Insert the key into the lock next to the rear door security lock label and turn it clockwise for the driver's side and counterclockwise for the passenger's side.
2. Close the door.

When you want to open a rear door when the security lock is on, do the following:

1. Unlock the door using the remote keyless entry transmitter, the front door power lock switch, or by lifting the rear door manual lock.
2. Open the door from the outside.

To cancel the rear door security lock, do the following:

1. Unlock the door and open it from the outside.
2. Insert the key into the slot next to the rear door security lock label and turn it counterclockwise for the driver's side and clockwise for the passenger's side.

Lockout Protection

If you press the power door lock switch when the key is in the ignition and any door is open, all the doors will lock and only the driver's door will unlock. Be sure to remove the key from the ignition when locking your vehicle.

Leaving Your Vehicle

If you are leaving the vehicle, open your door and set the locks from the inside. Then get out and close the door.

Trunk/Liftgate

CAUTION:

It can be dangerous to drive with the trunk or liftgate open because carbon monoxide (CO) gas can come into your vehicle. You can not see or smell CO. It can cause unconsciousness and even death. If you must drive with the trunk or liftgate open or if electrical wiring or other cable connections must pass through the seal between the body and the trunk or liftgate:

- Make sure all other windows are shut.
- Turn the fan on your heating or cooling system to its highest speed and select the control setting that will force outside air into your vehicle. See *Climate Control System on page 3-17*.
- If you have air outlets on or under the instrument panel, open them all the way.

See *Engine Exhaust on page 2-31*.

Trunk (Sedan)



To open the trunk on your sedan from outside of your vehicle you may either insert the key into the lock cylinder and turn the key clockwise, or press the trunk release button.

To open the trunk on your sedan from inside your vehicle, push the trunk release button located on the instrument panel to the left of the steering wheel.

Your trunk release button will not function if the vehicle is moving.

Liftgate Release (Wagon)

Unlock the liftgate by doing any of the following:

- Press the unlock button on your remote keyless entry transmitter twice.
- Press the liftgate button on your transmitter.
- Press the interior door unlock switch.
- Enable the automatic door unlocking feature.
- Insert the key into the liftgate and turn it clockwise to open the liftgate.

Once the liftgate is unlocked, it can be opened by pressing the liftgate key cylinder button.

The liftgate will lock automatically when closed and the vehicle detects a speed greater than 3 mph (5 km).

CAUTION:

It can be dangerous to drive with the trunk or liftgate open because carbon monoxide (CO) gas can come into your vehicle. You can not see or smell CO. It can cause unconsciousness and even death. If you must drive with the trunk or liftgate open or if electrical wiring or other cable connections must pass through the seal between the body and the trunk or liftgate:

- **Make sure all other windows are shut.**
- **Turn the fan on your heating or cooling system to its highest speed and select the control setting that will force outside air into your vehicle. See *Climate Control System on page 3-17*.**
- **If you have air outlets on or under the instrument panel, open them all the way.**

See *Engine Exhaust on page 2-31*.

Emergency Trunk Release Handle (Sedan)

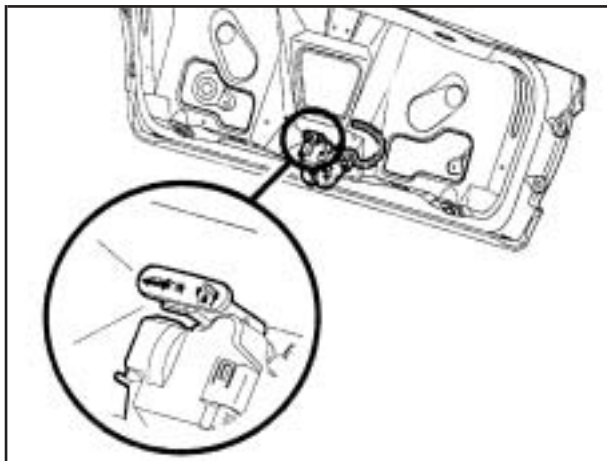

There is a glow-in-the-dark trunk release handle located inside the trunk near the bottom edge of the trunk lid. This handle will glow following exposure to light.

Notice: Using the emergency trunk release handle as a tie-down or anchor point when securing items in the trunk may damage it. Use the emergency trunk release handle only to help you open the trunk lid.

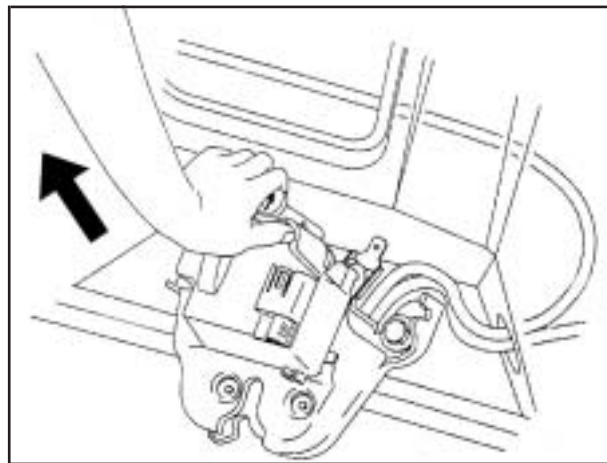

Pull the t-shaped trunk release handle straight back to open the trunk from the inside.

Trap-Resistant Trunk Kit

To help prevent a child from becoming trapped in your trunk, you can order a trap-resistant trunk kit from your retailer. This kit includes:

- A modified trunk latch.
- A lighted release handle.

See your retailer for additional information.

Windows

CAUTION:

Leaving children, helpless adults, or pets in a vehicle with the windows closed is dangerous. They can be overcome by the extreme heat and suffer permanent injuries or even death from heat stroke. Never leave a child, a helpless adult, or a pet alone in a vehicle, especially with the windows closed in warm or hot weather.



Manual Windows

On a vehicle with manual windows, use the window crank to open and close each window.

Power Windows



Switches are located on each side of the shift lever on the console. To open a window press the switch down and lift up to close it.

The power windows can operate only when the ignition key is in the RUN or the ACC position.

A rear window switch is located on each rear door. Press the bottom half of the switch to open the window and the top to close it.

Express-Down Window

The driver's window switch has an express-down feature that is labeled AUTO. Press the switch all the way down and hold it there momentarily, and the driver's window will go all the way down. To stop the automatic function, lift the switch all the way up and release it.

Window Lock Out

The driver's window controls also include a lock-out switch. Press the window lock switch to the left to stop rear passengers from using their window switches. The driver can still control all the windows with the lock on. Press the right side of the window lock button to return to normal window operation.

Sun Visors

To block out glare swing the visors down or to the side.

Visor Vanity Mirrors

Your vehicle has covered visor vanity mirrors. Some models have illuminated visor vanity mirrors for the driver only or for the driver and right front passenger. When you lift the cover the light will automatically come on, even when the ignition is off.

Theft-Deterrent Systems

Vehicle theft is big business, especially in some cities. Although your vehicle has a number of theft-deterrent features, we know that nothing we put on it can make it impossible to steal.

Passlock[®]

Your vehicle is equipped with the Passlock[®] theft-deterrent system.



This light will come on for the theft-deterrent system.

Passlock[®] is a passive theft-deterrent system. Passlock[®] enables fuel if the ignition lock cylinder is turned with a valid key. If a correct key is not used or the ignition lock cylinder is tampered with, fuel is disabled.

During normal operation, the security light will go off approximately five seconds after the key is turned to the RUN ignition position following an engine start.

If the engine stalls and the security light flashes, wait until the light stops flashing before trying to restart the engine. Remember to release the key from START as soon as the engine starts.

If the engine is running and the security light comes on, you will be able to restart the engine if you turn the engine off. However, your Passlock® system is not working properly and must be serviced by your retailer. Your vehicle is not protected by Passlock® at this time. You may also want to check the fuses, see *Fuses and Circuit Breakers on page 5-92*. See your retailer for service. Also, see *Roadside Assistance Program on page 7-6* for more information.

Starting and Operating Your Vehicle

New Vehicle Break-In

Notice: Your vehicle does not need an elaborate “break-in.” But it will perform better in the long run if you follow these guidelines:

- Do not drive at any one speed — fast or slow — for the first 500 miles (805 km). Do not make full-throttle starts.
- Avoid making hard stops for the first 200 miles (322 km) or so. During this time your new brake linings are not yet broken in. Hard stops with new linings can mean premature wear and earlier replacement. Follow this breaking-in guideline every time you get new brake linings.
- Do not tow a trailer during break-in. See *Towing a Trailer on page 4-40* for more information.

Ignition Positions

With the key in the ignition switch, you can turn the switch to four positions.



OFF: This position locks your steering column in a vehicle with a manual transmission. It is a theft-deterrent feature. You will only be able to remove your key when the ignition is turned to OFF.

Notice: If your key seems stuck in LOCK and you can not turn it, be sure you are using the correct key; if so, is it all the way in? If it is, then turn the steering wheel left and right while you turn the key hard. Turn the key only with your hand. Using a tool to force it could break the key or the ignition switch. If none of these works, then your vehicle needs service.

ACC (Accessory): This is the position in which you can operate your electrical accessories. With the key in this position, the ignition and automatic transaxle will unlock. Use this position if your vehicle must be pushed or towed.

RUN: This is the position for driving to which the switch returns after you start the engine and release the switch. The switch stays in RUN when the engine is running. But even when the engine is not running, you can use RUN to operate your electrical accessories and to display some instrument panel cluster messages and warning lights.

START: This position starts the engine. When the engine starts, release the key. The ignition switch will return to RUN for normal driving.

Starting Your Engine

Automatic Transaxle

Move your shift lever to PARK (P) or NEUTRAL (N). Your engine won't start in any other position — that is a safety feature. To restart when you're already moving, use NEUTRAL (N) only.

Notice: Shifting into PARK (P) with the vehicle moving could damage the transaxle. Shift into PARK (P) only when your vehicle is stopped.

Starting Your Engine

1. With your foot off the accelerator pedal, turn your ignition key to START. When the engine starts, let go of the key. The idle speed will go down as your engine gets warm.

Notice: Holding your key in START for longer than 15 seconds at a time will cause your battery to be drained much sooner. And the excessive heat can damage your starter motor. Wait about 15 seconds between each try to help avoid draining your battery or damaging your starter.

2. If it does not start, wait about 15 seconds and try again to start the engine by turning the ignition key to START. Wait about 15 seconds between each try.

When your engine has run about 10 seconds to warm up, your vehicle is ready to be driven. Don't race your engine when it's cold.

If the weather is below freezing (32°F or 0°C), let the engine run for a few minutes to warm up.

3. If your engine still will not start (or starts but then stops), it could be flooded with too much gasoline. Try pushing your accelerator pedal all the way to the floor and holding it there as you hold the key in START for about three seconds. If the vehicle starts briefly but then stops again, do the same thing, but this time keep the pedal down for five or six seconds. This clears the extra gasoline from the engine.

Notice: Your engine is designed to work with the electronics in your vehicle. If you add electrical parts or accessories, you could change the way the engine operates. Before adding electrical equipment, check with your dealer. If you do not, your engine might not perform properly.

Engine Coolant Heater

If your vehicle has this feature, in very cold weather, -20°F (-29°C) or colder, the engine coolant heater can help. You'll get easier starting and better fuel economy during engine warm-up. Usually, the coolant heater should be plugged in a minimum of four hours prior to starting your vehicle. At temperatures above 32°F (0°C), use of the coolant heater is not required.

To Use the Engine Coolant Heater

1. Turn off the engine.
2. Open the hood and unwrap the electrical cord. The electrical cord is located in front of the engine coolant surge tank on the passenger's side.
3. Plug it into a normal, grounded 110-volt AC outlet.

CAUTION:

Plugging the cord into an ungrounded outlet could cause an electrical shock. Also, the wrong kind of extension cord could overheat and cause a fire. You could be seriously injured. Plug the cord into a properly grounded three-prong 110-volt AC outlet. If the cord will not reach, use a heavy-duty three-prong extension cord rated for at least 15 amps.

4. Before starting the engine, be sure to unplug and store the cord as it was before to keep it away from moving engine parts. If you do not, it could be damaged.

How long should you keep the coolant heater plugged in? The answer depends on the outside temperature, the kind of oil you have, and some other things. Instead of trying to list everything here, we ask that you contact your retailer in the area where you'll be parking your vehicle. The retailer can give you the best advice for that particular area.

Automatic Transaxle Operation



Your vehicle is equipped with an automatic transaxle, the shift lever is located on the console between the seats.

There are several positions for the shift lever.

PARK (P): This position locks your front wheels. It's the best position to use when you start your engine because your vehicle can't move easily.

CAUTION:

It is dangerous to get out of your vehicle if the shift lever is not fully in PARK (P) with the parking brake firmly set. Your vehicle can roll.

Do not leave your vehicle when the engine is running unless you have to. If you have left the engine running, the vehicle can move suddenly. You or others could be injured. To be sure your vehicle will not move, even when you are on fairly level ground, always set your parking brake and move the shift lever to PARK (P). See *Shifting Into Park (P) (Automatic Transaxle)* on page 2-28. If you are pulling a trailer, see *Towing a Trailer* on page 4-40.

Ensure the shift lever is fully in PARK (P) before starting the engine. Your vehicle has an automatic transaxle shift lock control system. You have to fully apply your regular brakes before you can shift from PARK (P) when the ignition key is in RUN. If you cannot shift out of PARK (P), ease pressure on the shift lever – push the shift lever all the way into PARK (P) and also release the shift lever button on floor shift console models as you maintain brake application.

Then move the shift lever into the gear you wish. Press the shift lever button before moving the shift lever. See *Shifting Out of Park (P)* on page 2-30.

REVERSE (R): Use this gear to back up.

Notice: Shifting to REVERSE (R) while your vehicle is moving forward could damage the transaxle. The repairs would not be covered by your warranty. Shift to REVERSE (R) only after your vehicle is stopped.

To rock your vehicle back and forth to get out of snow, ice or sand without damaging your transaxle, see *If You Are Stuck: In Sand, Mud, Ice or Snow* on page 4-30.

NEUTRAL (N): In this position, your engine doesn't connect with the wheels. To restart when you're already moving, use NEUTRAL (N) only. Also, use NEUTRAL (N) when your vehicle is being towed.

 **CAUTION:**

Shifting into a drive gear while your engine is running at high speed is dangerous. Unless your foot is firmly on the brake pedal, your vehicle could move very rapidly. You could lose control and hit people or objects. Do not shift into a drive gear while your engine is running at high speed.

Notice: Shifting out of PARK (P) or NEUTRAL (N) with the engine racing may damage the transaxle. The repairs would not be covered by your warranty. Be sure the engine is not racing when shifting your vehicle.

AUTOMATIC OVERDRIVE (D): This position is for normal driving with the automatic transaxle. If you need more power for passing, and you're:

- Going less than about 35 mph (55 km/h), push your accelerator pedal about halfway down.
- Going about 35 mph (55 km/h), push your accelerator all the way down.

Notice: If your vehicle seems to start up rather slowly, or if it seems not to shift gears as you go faster, something may be wrong with a transaxle system sensor. If you drive very far that way, your vehicle can be damaged. So, if this happens, have your vehicle serviced right away. Until then, you can use **SECOND (2)** when you are driving less than 35 mph (55 km/h) and **THIRD (3)** for higher speeds.

THIRD (3): This position is also used for normal driving, however, it offers more power and lower fuel economy than **AUTOMATIC OVERDRIVE (D)**. Here are some times you might choose **THIRD (3)** instead of **AUTOMATIC OVERDRIVE (D)**:

- When driving on hilly, winding roads.
- When going down a steep hill.

SECOND (2): This position gives you more power, but lower fuel economy than **THIRD (3)**. You can use **SECOND (2)** on hills. It can help control your speed as you go down steep mountain roads, but then you would also want to use your brakes off and on.

Notice: Driving in **SECOND (2)** for more than 25 miles (40 km) or at speeds over 55 mph (90 km/h) may damage the transaxle. Also, shifting into **SECOND (2)** at speeds above 65 mph (105 km/h) can cause damage. Drive in **THIRD (3)** or **AUTOMATIC OVERDRIVE (D)** instead of **SECOND (2)**.

FIRST (1): This position gives you even more power but lower fuel economy than **SECOND (2)**. You can use it on very steep hills, or in deep snow or mud. If the shift lever is put in **FIRST (1)**, the transaxle will not shift into first gear until the vehicle is going slowly enough.

Notice: Spinning the tires or holding the vehicle in one place on a hill using only the accelerator pedal may damage the transaxle. If you are stuck, do not spin the tires. When stopping on a hill, use the brakes to hold the vehicle in place.

Shift Lock Release

If you ever hold the brake pedal down, but still cannot shift out of PARK (P), try this:

1. Turn the ignition to OFF and remove the key.



2. Carefully pry the shift lock override cover from the floor shift console.



3. Lift up and forward to disengage.

4. While maintaining brake application, pull up and hold the white lever and then move the shift lever into the desired gear position.
5. Have the vehicle fixed as soon as possible.

Parking Brake

The parking brake lever is located between the bucket seats.

When parking your vehicle, set the parking brake before shifting your automatic transaxle into PARK (P).



To set the parking brake, hold the brake pedal down and pull up on the parking brake lever. If the ignition is on, the brake system warning light will come on.



To release the parking brake, hold the brake pedal down. Pull the parking brake lever up until you can press the release button. Hold the release button in as you move the brake lever all the way down.

Notice: Driving with the parking brake on can overheat the brake system and cause premature wear or damage to brake system parts. Verify that the parking brake is fully released and the brake warning light is off before driving.

If you are towing a trailer and parking on a hill, see *Towing a Trailer* on page 4-40 for more information.

Shifting Into Park (P) (Automatic Transaxle)

CAUTION:

It can be dangerous to get out of your vehicle if the shift lever is not fully in PARK (P) with the parking brake firmly set. Your vehicle can roll. If you have left the engine running, the vehicle can move suddenly. You or others could be injured. To be sure your vehicle will not move, even when you are on fairly level ground, use the steps that follow. If you are pulling a trailer, see *Towing a Trailer on page 4-40*.



1. Hold the brake pedal down and set the parking brake.
2. Move the shift lever into the PARK (P) position like this:
 - Hold in the button on the shift lever.
3. Turn the ignition key to OFF.
4. Remove the key and take it with you. If you can leave your vehicle with the ignition key in your hand, your vehicle is in PARK (P).

Leaving Your Vehicle With the Engine Running

CAUTION:

It can be dangerous to leave your vehicle with the engine running. Your vehicle could move suddenly if the shift lever is not fully in PARK (P) with the parking brake firmly set. And, if you leave the vehicle with the engine running, it could overheat and even catch fire. You or others could be injured. Do not leave your vehicle with the engine running.

If you have to leave your vehicle with the engine running, be sure your vehicle is in PARK (P) and your parking brake is firmly set before you leave it. After you've moved the shift lever into PARK (P), hold the regular brake pedal down. Then, see if you can move the shift lever away from PARK (P) without first pushing the button. If you can, it means that the shift lever wasn't fully locked into PARK (P).

Torque Lock

If you are parking on a hill and you don't shift your transaxle into PARK (P) properly, the weight of the vehicle may put too much force on the parking pawl in the transaxle. You may find it difficult to pull the shift lever out of PARK (P). This is called "torque lock." To prevent torque lock, set the parking brake and then shift into PARK (P) properly before you leave the driver's seat. To find out how, see *Shifting Into Park (P) (Automatic Transaxle)* on page 2-28.

When you are ready to drive, move the shift lever out of PARK (P) *before* you release the parking brake.

If torque lock does occur, you may need to have another vehicle push yours a little uphill to take some of the pressure from the parking pawl in the transaxle, so you can pull the shift lever out of PARK (P).

Shifting Out of Park (P)

Your vehicle has an automatic transaxle shift lock control system. You have to fully apply your regular brakes before you can shift from PARK (P) when the ignition is in RUN. See *Automatic Transaxle Operation* on page 2-23.

If you cannot shift out of PARK (P), ease pressure on the shift lever and push the shift lever all the way into PARK (P), while pressing the button on the shift lever and maintaining brake application. Then move the shift lever into the gear you wish.

If you ever hold the brake pedal down but still can't shift out of PARK (P), try this:

1. Turn the key to OFF.
2. Apply and hold the brake until the end of Step 4.
3. Shift to NEUTRAL (N).
4. Start the vehicle and then shift to the drive gear you want.
5. Have your vehicle fixed as soon as you can.

Parking Over Things That Burn



CAUTION:

Things that can burn could touch hot exhaust parts under your vehicle and ignite. Do not park over papers, leaves, dry grass or other things that can burn.

Engine Exhaust

CAUTION:

Engine exhaust can kill. It contains the gas carbon monoxide (CO), which you can not see or smell. It can cause unconsciousness and death.

You might have exhaust coming in if:

- Your exhaust system sounds strange or different.
- Your vehicle gets rusty underneath.

CAUTION: (Continued)

CAUTION: (Continued)

- Your vehicle was damaged in a collision.
- Your vehicle was damaged when driving over high points on the road or over road debris.
- Repairs were not done correctly.
- Your vehicle or exhaust system had been modified improperly.

If you ever suspect exhaust is coming into your vehicle:

- Drive it only with all the windows down to blow out any CO; and
- Have your vehicle fixed immediately.

Running Your Engine While You Are Parked

It is better not to park with the engine running. But if you ever have to, here are some things to know.

CAUTION:

Idling the engine with the climate control system off could allow dangerous exhaust into your vehicle. See the earlier Caution under *Engine Exhaust on page 2-31*.

Also, idling in a closed-in place can let deadly carbon monoxide (CO) into your vehicle even if the climate control fan is at the highest setting. One place this can happen is a garage. Exhaust — with CO — can come in easily. **NEVER** park in a garage with the engine running.

Another closed-in place can be a blizzard. See *Winter Driving on page 4-26*.

CAUTION:

It can be dangerous to get out of your vehicle if the shift lever is not fully in PARK (P) with the parking brake firmly set. Your vehicle can roll. Do not leave your vehicle when the engine is running unless you have to. If you have left the engine running, the vehicle can move suddenly. You or others could be injured. To be sure your vehicle will not move, even when you are on fairly level ground, always set your parking brake and move the shift lever to PARK (P).

Follow the proper steps to be sure your vehicle will not move. See *Shifting Into Park (P) (Automatic Transaxle) on page 2-28*.

If you are parking on a hill and if you are pulling a trailer, also see *Towing a Trailer on page 4-40*.

Mirrors

Manual Rearview Mirror

While you are sitting in a comfortable driving position, adjust the mirror so you can see clearly behind your vehicle. Grip the mirror in the center to move it up or down and side to side. The day/night adjustment, located at the bottom of the mirror, allows you to adjust the mirror to avoid glare from the lamps behind you. Pull the tab forward for daytime use; push it back for night use.

Manual Rearview Mirror with OnStar®

If your vehicle has this feature, this mirror has a lever located at the bottom of the mirror. It is used to change the mirror from day to night position. To reduce glare from headlamps behind you while driving at night, pull the lever toward you. To return the mirror to the day position, return the lever to its original position.



There are also three OnStar® buttons located at the bottom of the mirror face. See your retailer for more information on the system and how to subscribe to OnStar®. See *OnStar® System on page 2-40* for more information about the services OnStar® provides.

Automatic Dimming Rearview Mirror with OnStar®, Compass and Temperature Display

Your vehicle may have this feature. When on, an automatic dimming mirror automatically dims to the proper level to minimize glare from lights behind you after dark.



The mirror also includes a dual display in the upper right corner of the mirror face. The compass reading and the outside temperature will both appear in the display at the same time.

 **(On/Off):** This is the on/off button.

Temperature and Compass Display

Press the on/off button, located to the far left, briefly to turn the comp/temp display on or off.

If the display reads CAL, you will need to calibrate the compass. For more information on calibration, see “Compass Calibration” later in this section.

To set the readings to appear in either Fahrenheit or Celsius do the following:

1. Press and hold the on/off button for approximately four seconds until either a flashing °F, or °C appears.
2. Press the button again to change the display to the desired unit of measurement. After approximately four seconds the unit of measurement will be set and the compass/temperature display will return.

Automatic Dimming Mirror Operation

The automatic dimming mirror function is turned on automatically each time the ignition is started. To operate the automatic dimming mirror do the following:

1. Make sure the indicator light, located to the left of the on/off button, is lit. If it's not, press and hold the on/off button for approximately six seconds until the light comes on, indicating that the mirror is in automatic dimming mode.
2. Turn off the automatic dimming mirror function by pressing and holding the on/off button for approximately six seconds until the indicator light turns off.

Compass Calibration

The compass may need calibration from time to time.

In order to calibrate, CAL must be displayed in the mirror compass windows. If CAL is not displayed, push in the on/off button for about nine seconds or until CAL is displayed.

The compass can be calibrated by driving the vehicle in circles at five mph (8 km/h) or less until the display reads a direction.

Compass Variance

Compass variance is the difference between earth's magnetic north and true geographic north. If not adjusted to account for compass variance, your compass could give false readings.

The mirror is set in zone eight upon leaving the factory. It will be necessary to adjust the compass to compensate for compass variance if you live outside of zone eight. Under certain circumstances, as during a long distance cross-country trip, it will be necessary to adjust for compass variance.

To adjust for compass variance do the following:

1. Find your current location and variance zone number on the following zone map.

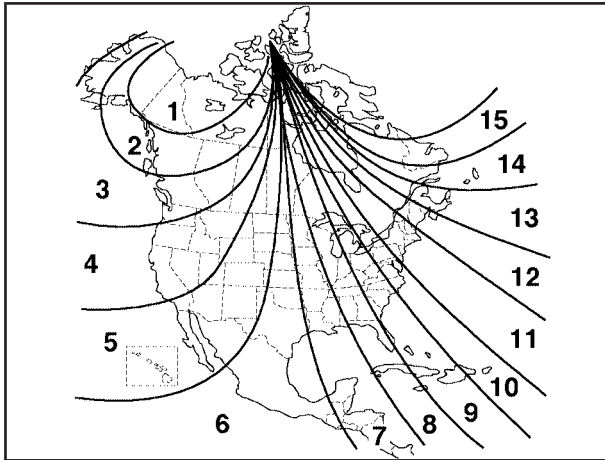

2. Press and hold the on/off button until a zone number appears in the display. The compass is now in zone mode.

3. Keep pressing the on/off button until the desired zone number appears in the display. Release the button. After approximately four seconds of inactivity, the new zone number will be locked in and the comp/temp display will return.

Cleaning the Mirror

When cleaning the mirror, use a paper towel or similar material dampened with glass cleaner. Do not spray glass cleaner directly on the mirror as that may cause the liquid cleaner to enter the mirror housing.

Automatic Dimming Rearview Mirror with Compass and Temperature Display

If your vehicle is equipped with an automatic dimming mirror it will automatically dim to the proper level to minimize glare from lights behind you after dark.

The mirror also includes a display in the upper right corner of the mirror face. The compass reading and the outside temperature will both appear in the display at the same time.

Temperature Display

The temperature can be displayed by pressing the TEMP button. Pressing the TEMP button once briefly, will toggle the temperature reading from Fahrenheit (°F), Celsius (°C), to off.

Automatic Dimming Mirror Operation

Press the COMP button to turn the automatic dimming feature on and off. An indicator light on the bottom of the mirror face will be on when the automatic dimming feature is on.

Compass Operation

Press the COMP button once briefly to turn the compass on or off.

When compass feature is on, the compass will show the direction the vehicle is traveling, with a maximum of two characters.

Compass Calibration

The compass may need calibration from time to time.

In order to calibrate, CAL must be displayed in the mirror compass windows. If CAL is not displayed, push in the COMP button for approximately six seconds or until CAL is displayed.

The compass can be calibrated by driving the vehicle in circles at five mph (8 km/h) or less until the display reads a direction.

Compass Variance

Compass variance is the difference between earth's magnetic north and true geographic north. If not adjusted to account for compass variance, your compass could give false readings.

The mirror is set in zone eight upon leaving the factory. It will be necessary to adjust the compass to compensate for compass variance if you live outside zone eight. Under certain circumstances, as during a long distance cross-country trip, it will be necessary to adjust for compass variance.

To adjust for compass variance:

1. Find your current location and variance zone number on the following zone map.

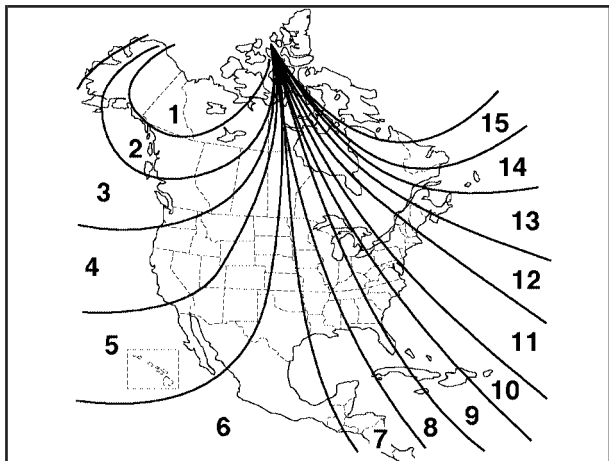

2. Press and hold the COMP button for five seconds until a zone number appears in the display.
3. Press the COMP button on the bottom of the mirror until the new zone number appears in the display. After you stop pressing the button, the display will show a compass direction within a few seconds.

Cleaning the Mirror

Use a paper towel or similar material dampened with glass cleaner. Do not spray glass cleaner directly on the mirror as that may cause the liquid cleaner to enter the mirror housing.

Outside Remote Control Mirror

To adjust the driver's side outside mirror, move the knob located on the driver's door. To adjust the passenger's side outside mirror, move the knob located on the passenger's door. Adjust each mirror so you can see the side of your vehicle and the area beside and behind your vehicle.

Outside Power Mirrors



The outside power mirror control is located on the driver's door.

Use the selector switch located above the round touch pad to choose either the left or right outside mirror. To adjust the mirror press the round touch pad in the desired direction.

Adjust each mirror so you can see the side of your vehicle and the area beside and behind your vehicle, while you are sitting in a comfortable driving position.

Outside Convex Mirror

Your passenger's side mirror is convex. A convex mirror's surface is curved so you can see more from the driver's seat.

CAUTION:

A convex mirror can make things (like other vehicles) look farther away than they really are. If you cut too sharply into the right lane, you could hit a vehicle on your right. Check your inside mirror or glance over your shoulder before changing lanes.

Outside Heated Mirrors

When you operate the rear window defogger, it also warms both outside rearview mirrors to help clear them of fog or ice. See *Climate Control System on page 3-17* or *Automatic Climate Control System on page 3-20*.

OnStar® System



OnStar® uses global positioning system (GPS) satellite technology, wireless communications, and call centers to provide you with a wide range of safety, security, information and convenience services.

A complete OnStar® user's guide and the terms and conditions of the OnStar® Subscription Service Agreement are included in your vehicle's glove box literature. For more information, visit www.onstar.com, contact OnStar® at 1-888-4-ONSTAR (1-888-466-7827), or press the blue OnStar® button to speak to an OnStar® advisor 24 hours a day, 7 days a week.

A completed Subscription Service Agreement is required prior to delivery of OnStar® services and prepaid calling minutes are also required for OnStar® Personal Calling and OnStar® Virtual Advisor use. Terms and conditions of the Subscription Service Agreement can be found at www.onstar.com.

OnStar® Services

One of the following plans is normally included for a specific duration with each vehicle equipped with OnStar®. You can upgrade or extend your OnStar® service plan to meet your needs.

Safe and Sound Plan

- Automatic Notification of Air Bag Deployment
- Emergency Services
- Roadside Assistance
- Stolen Vehicle Assistance
- AccidentAssist
- Remote Door Unlock
- Remote Diagnostics
- Online Concierge

Directions and Connections Plan

- All Safe and Sound Plan services
- Route Support
- RideAssist
- Information and Convenience Services

Luxury and Leisure Plan

- All Directions and Connections Plan services
- Personal Concierge

OnStar® Personal Calling

With OnStar® Personal Calling, you have a safer way to stay connected while driving. It's a hands-free wireless phone that's integrated into your vehicle. You can place calls nationwide using voice-activated dialing with no contracts and no additional roaming charges. To find out more about OnStar® Personal Calling, refer to the OnStar® user's guide in your vehicle's glove box, or call OnStar® at 1-888-4-ONSTAR (1-888-466-7827).

OnStar® Virtual Advisor

With OnStar® Virtual Advisor you can listen to the news, entertainment and informative topics, such as traffic and weather reports. You are able to listen and reply to your e-mail through your vehicle's speakers.

Storage Areas

Glove Box

Use the key to lock and unlock the glove box. To open, lift the latch.

Center Console Storage Area

Your vehicle may be equipped with a center console. To open the console's storage area, pull up on the latch located in the front of the console lid.

Assist Handles

A handle above the front passenger's door and both rear doors can be used when getting in and out of your vehicle. The assist handle provides assistance, but should not be used to support all or even a substantial portion of a person's weight.

Load Floor Storage Box

Some wagon models have a load floor storage box, which is located in the rear of the vehicle. This storage space is designed to hold small items.

Roof Rack System

Your vehicle may have the roof rack system to load things on.

CAUTION:

If you try to carry something on top of your vehicle that is longer or wider than the luggage carrier — like paneling, plywood, a mattress and so forth — the wind can catch it as you drive along. This can cause you to lose control.

CAUTION: (Continued)

CAUTION: (Continued)

What you are carrying could be violently torn off, and this could cause you or other drivers to have a collision, and of course damage your vehicle. You may be able to carry something like this inside. But, never carry something longer or wider than the luggage carrier on top of your vehicle.

Notice: Loading cargo on the luggage carrier that weighs more than 100 lbs. (45 kg) or hangs over the rear or sides of the vehicle may damage your vehicle. Load cargo so that it rests on the slats as far forward as possible and against the side rails, making sure to fasten it securely.

Do not exceed the maximum vehicle capacity when loading your vehicle. For more information on vehicle capacity and loading, see *Loading Your Vehicle on page 4-34*.

To prevent damage or loss of cargo as you're driving, check frequently to ensure your cargo is securely fastened.

Cargo Cover

Wagon models are equipped with a rear compartment cargo shade. The cargo shade will help to hide valuables placed in the rear compartment of your vehicle.

Here's how to use the cargo shade:

1. Open the liftgate.
2. Grasp the handle on the shade and pull it toward you.



3. Hook the slides of the shade into the notches on either side of the liftgate opening.

If your cargo shade becomes soiled, it may be cleaned using the same method as outlined in the vinyl cleaning section in this handbook. See *Cleaning the Inside of Your Vehicle on page 5-82* for more information.

Removing the Cargo Cover

To remove the cargo shade:

1. Unhook the shade and allow it to retract all the way.



2. Grasp the shade on the driver's side of the vehicle and move it toward the passenger's side, compressing the spring.
3. Lift up the end of the shade on the driver's side of the vehicle and remove the cargo shade from the vehicle.

CAUTION:

An improperly stored cargo shade could be thrown about the vehicle during a collision or sudden maneuver. You or others could be injured. If you remove the shade, always store it outside of the vehicle. When you put it back, always be sure that it is securely installed.

Installing the Cargo Shade

To install the cargo shade:

1. Insert one end of the shade into the slot on the passenger's side of the vehicle.
2. Move the shade toward the passenger's side to compress the spring, and lower the shade into the slot on the driver's side of the vehicle.

After you've installed the cargo shade, check to make sure it's secure by trying to lift the shade up without moving it toward the driver's or passenger's side. If you can lift the cargo shade up, it isn't secure.

Sunroof

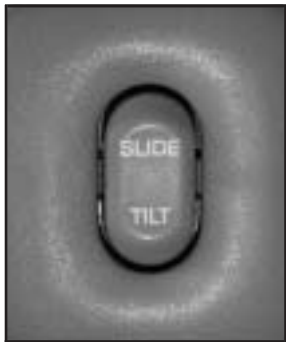

If your vehicle has this feature, the switch will be located above your rearview mirror. Your ignition key must be in the RUN or ACC position to operate the sunroof.

To open the sunroof three-quarters of the way, press and hold the SLIDE portion of the switch. To open the sunroof all the way, press and hold the SLIDE portion of the switch again. To close the sunroof, press and hold the TILT portion of the switch.

To place the sunroof in the vent position when the sunroof is closed, press and hold the TILT portion of the switch. The rear of the sunroof will be raised to provide ventilation. To close the sunroof from the vent position, press and hold the SLIDE portion of the switch.

 **NOTES**

Section 3 Instrument Panel

Instrument Panel Overview	3-2	Traction Control System (TCS) Warning Light	3-32
Hazard Warning Flashers	3-4	Engine Coolant Temperature Warning Light	3-32
Other Warning Devices	3-5	Engine Coolant Temperature Gage	3-33
Horn	3-5	Low Coolant Warning Light	3-33
Tilt Wheel	3-5	Malfunction Indicator Lamp	3-34
Turn Signal/Multifunction Lever	3-6	Oil Pressure Light	3-37
Windshield Wiper Lever	3-8	Change Engine Oil Light	3-38
Cruise Control	3-10	Security Light	3-38
Exterior Lamps	3-13	Reduced Engine Power Light	3-38
Interior Lamps	3-15	Daytime Running Lamps Indicator Light	3-39
Accessory Power Outlets	3-16	Low Washer Fluid Warning Light	3-39
Ashtrays and Cigarette Lighter	3-17	Trunk Ajar Light	3-39
Climate Controls	3-17	Service Vehicle Soon Light	3-39
Climate Control System	3-17	Fuel Gage	3-40
Automatic Climate Control System	3-20	Low Fuel Warning Light	3-40
Outlet Adjustment	3-24	Audio System(s)	3-41
Passenger Compartment Air Filter	3-24	Setting the Time	3-41
Warning Lights, Gages, and Indicators	3-25	AM-FM Radio	3-42
Instrument Panel Cluster	3-26	Radio with CD	3-45
Speedometer and Odometer	3-27	Radio with Cassette and CD	3-50
Tachometer	3-27	Rear Seat Entertainment System	3-59
Safety Belt Reminder Light	3-28	Theft-Deterrent Feature	3-69
Air Bag Readiness Light	3-28	Radio Reception	3-71
Battery Warning Light	3-29	Care of Your Cassette Tape Player	3-72
Brake System Warning Light	3-30	Care of Your CDs and DVDs	3-73
Anti-Lock Brake System Warning Light	3-31	Care of Your CD and DVD Player	3-73
		Fixed Mast Antenna	3-73

Instrument Panel Overview

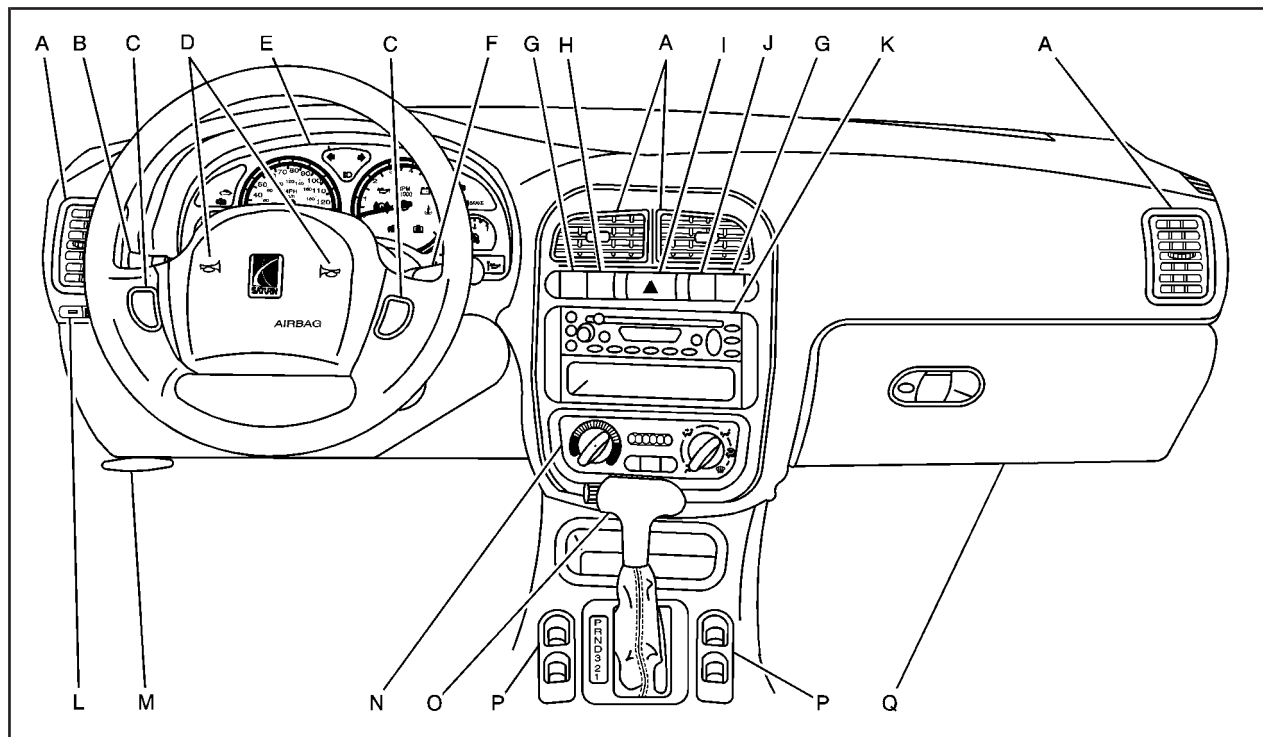

The main components of the instrument panel are the following:

- A. Air Outlets. See *Outlet Adjustment on page 3-24*.
- B. Turn Signal/Multifunction Lever. See *Turn Signal/Multifunction Lever on page 3-6*.
- C. Cruise Control (If Equipped). See *Cruise Control on page 3-10*.
- D. Horn. See *Horn on page 3-5*.
- E. Instrument Panel Cluster. See *Instrument Panel Cluster on page 3-26*.
- F. Windshield Wiper Lever. See *Windshield Wiper Lever on page 3-8*.
- G. Heated Seats (If Equipped). See *Heated Seats on page 1-5*.
- H. Fog Lamps (If Equipped). See *Interior Lamps on page 3-15*.
- I. Hazard Warning Flasher Button. See *Hazard Warning Flashers on page 3-4*.
- J. Traction Control. See *Traction Control System (TCS) Warning Light on page 3-32*.
- K. Audio System. See *Audio System(s) on page 3-41*.
- L. Trunk Release Button/Dimmer Switch. See *Trunk/Liftgate on page 2-13 /Interior Lamps on page 3-15*.
- M. Hood Release. See *Hood Release on page 5-10*.
- N. Climate Control. See *Climate Control System on page 3-17*.
- O. Automatic Transaxle Shift Lever. See *Automatic Transaxle Operation on page 2-23*.
- P. Power Windows. See *Power Windows on page 2-17*.
- Q. Glove Box. See *Glove Box on page 2-41*.

Hazard Warning Flashers

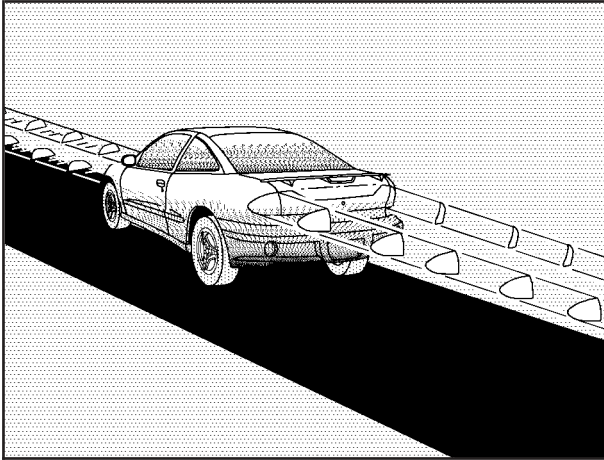

Your hazard warning flashers let you warn others. They also let police know you have a problem. Your front and rear turn signal lamps will flash on and off.

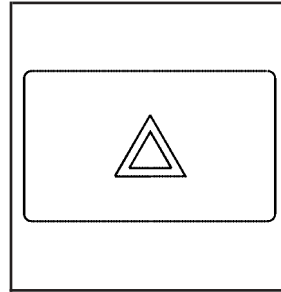

The hazard warning flasher button is located near the center of the instrument panel.

Your hazard warning flashers work no matter what position your key is in, and even if the key is not in.

Press the button to make the front and rear turn signal lamps flash on and off. Press the button again to turn the flashers off.

When the hazard warning flashers are on, your turn signals will not work. Make sure the hazard warning flasher switch is all the way to the left for normal turn signal operation.

Other Warning Devices

If you carry reflective triangles, you can set one up at the side of the road about 300 feet (100 m) behind your vehicle.

Horn

You can sound the horn by pressing the center of your steering wheel.

Tilt Wheel

Your vehicle may have a tilt wheel which allows you to adjust the steering wheel before you drive. You can raise it to the highest level to give your legs more room when you exit and enter the vehicle.

The lever that allows you to tilt the steering wheel is located on the left side of the steering column.



To tilt the wheel, hold the wheel and pull the lever. Then, move the wheel to a comfortable position and release the lever to lock the wheel in place.

Turn Signal/Multifunction Lever

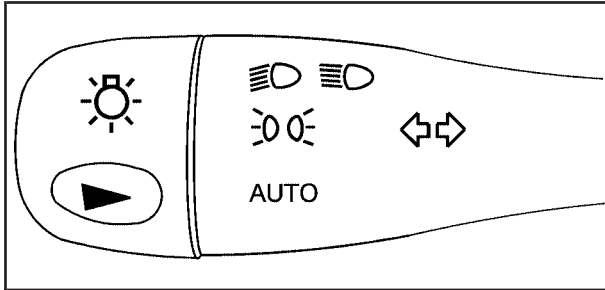

The lever on the left side of the steering column includes the following:

- Turn and Lane-Change Signals
- Headlamps
- Headlamp High/Low-Beam Changer
- Flash-to-Pass Feature

For additional information on the exterior lamps, see *Exterior Lamps* on page 3-13.

Turn and Lane-Change Signals

The turn signal has two upward (for right) and two downward (for left) positions. These positions allow you to signal a turn or a lane change.

To signal a turn, move the lever all the way up or down. When the turn is finished, the lever will return automatically.

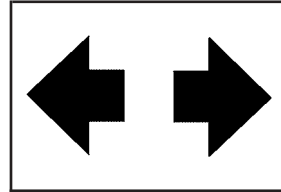

An arrow on the instrument panel cluster will flash in the direction of the turn or lane change.

To signal a lane change, raise or lower the lever until the arrow starts to flash. Hold it there until you complete the lane change. The lever will return by itself when you release it.

As you signal a turn or a lane change, if the arrows flash rapidly, a signal bulb may be burned out and other drivers won't see your turn signal.

If a bulb is burned out, replace it to help avoid an accident. If the arrows do not go on at all when you signal a turn, check the fuse, see *Fuses and Circuit Breakers* on page 5-92 and for burned-out bulbs.

Headlamp High/Low-Beam Changer

To change the headlamps from low beam to high or high beam to low, pull the turn signal lever all the way towards you. Then release it.

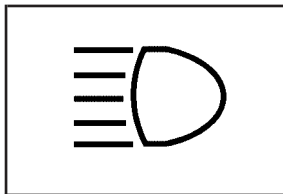

When the high beams are on, this light on the instrument panel cluster will also be on.

Flash-to-Pass

This feature lets you use your high-beam headlamps to signal a driver in front of you that you want to pass.

To use it, pull the turn signal/multifunction lever toward you until the high-beam headlamps come on, then release the lever to turn them off.

Headlamps

The exterior lamp control is located in the middle of the turn signal/multifunction lever.

 **(Exterior Lamp Control):** Turn the control with this symbol on it to operate the exterior lamps.

The exterior lamp control has the following four positions:

AUTO (Automatic): Turn the control to this position to put the headlamps in automatic mode. AUTO mode will turn the exterior lamps on and off depending upon how much light is available outside of the vehicle.

 **(Parking Lamps):** Turn the control to this position to turn on the parking lamps together with the following:

- Sidemarkers Lamps
- Taillamps
- License Plate Lamps
- Instrument Panel Lights

 **(Headlamps):** Turning the control to this position turns on the headlamps, together with the previously listed lamps and lights.

Lamps On Reminder

If you open the driver's door with the ignition off and the lamps on, you will hear a warning chime.

Windshield Wiper Lever

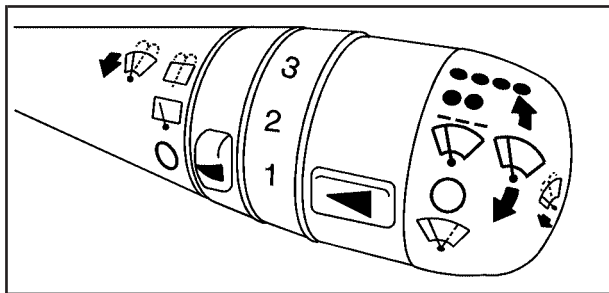



The lever on the right side of the steering column operates the windshield wipers.

 : Pull the lever down and release it for a single wiping cycle. The lever will return to its original position. For more cycles, hold the lever down before releasing it.

 : Put the lever in this position to turn off the wipers.

 : Put the lever in this position to set a delay between wipes. Turn the band on the lever to set the length of the delay (1, 2, or 3).

 : Put the lever in this position for slow, steady wiping cycles.

 : Put the lever in this position for rapid wiping cycles.

Be sure to clear ice and snow from the wiper blades before using them. If they're frozen to the windshield, gently loosen or thaw them. If the blades do become damaged, install new blades or blade inserts.

Heavy snow or ice can overload the wiper motor. A circuit breaker will stop the motor until it cools down. Clear away snow or ice to prevent an overload.

Windshield Washer

CAUTION:



In freezing weather, do not use your washer until the windshield is warmed. Otherwise the washer fluid can form ice on the windshield, blocking your vision.

Pull the windshield wiper lever toward you to operate the windshield wipers. Washer fluid will squirt onto the windshield and the wipers will run for a few cycles to clear the windshield. For more wash cycles, pull the lever toward you and hold it there.

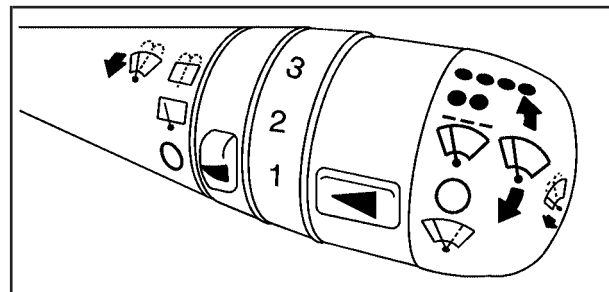
Rear Window Wiper/Washer (Wagon)



There is a band on the wiper lever to operate the rear wiper/washer.

-  : Put the band in this position to turn off the rear wiper.
-  : Put the band in this position to turn on the rear wiper. This position will be slow, steady wiping cycles.
-  (**Wash**): Hold the band in this position to spray washer fluid on the rear window. The rear wiper will also come on. Release the band when enough fluid has been sprayed on the window. The rear wiper will stay on until you turn the band to OFF.

Cruise Control

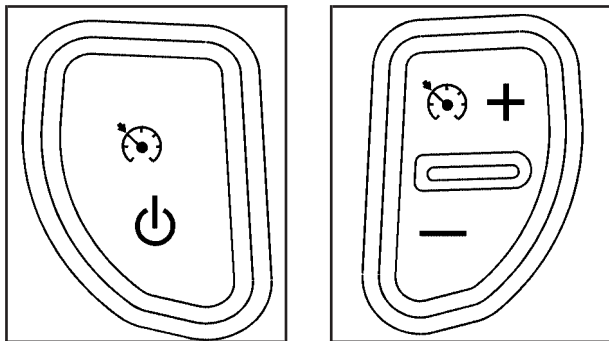

The buttons for the cruise control are located on the steering wheel.

 **(Cruise On/Off):** Push this button to turn the system on and off.

 **(Resume/Accelerate):** Push this button to make the vehicle resume a previously set speed or to accelerate when cruise is already active.

-(Set/Coast): Press this button to set the speed or to decrease the speed when cruise is already active.

With cruise control, you can maintain a speed of about 25 mph (40 km/h) or more without keeping your foot on the accelerator. This can really help on long trips. Cruise control does not work at speeds below about 25 mph (40 km/h).

If you apply your brakes, the cruise control will shut off.

CAUTION:

Cruise control can be dangerous where you can not drive safely at a steady speed. So, do not use your cruise control on winding roads or in heavy traffic.

Cruise control can be dangerous on slippery roads. On such roads, fast changes in tire traction can cause needless wheel spinning, and you could lose control. Do not use cruise control on slippery roads.

If your vehicle is in cruise control when the traction control system begins to limit wheel spin, the cruise control will automatically disengage. See *Traction Control System (TCS) on page 4-9*. When road conditions allow you to safely use it again, you may turn the cruise control back on.

Setting Cruise Control

CAUTION:

If you leave your cruise control on when you are not using cruise, you might hit a button and go into cruise when you do not want to. You could be startled and even lose control. Keep the cruise control switch off until you want to use cruise control.

1. Press the cruise on/off button. The indicator light will come on.
2. Get up to the speed you want.
3. Press the set/coast button.
4. Take your foot off the accelerator pedal.

Resuming a Set Speed

Suppose you set your cruise control at a desired speed and then you apply the brake. This, of course, disengages the cruise control. But you don't need to reset it.

Once you're going about 25 mph (40 km/h) or more, you can press the cruise control res/accel button.

You will go right back up to your chosen speed and stay there.

If you hold the res/accel button the vehicle will keep going faster until you release the button or apply the brake. So unless you want to go faster, do not hold the res/accel button.

Increasing Speed While Using Cruise Control

There are two ways to go to a higher speed:

- Use the accelerator pedal to get to the higher speed. Press the set/coast button, then release the button and the accelerator pedal. You'll now cruise at the higher speed.
- Press the res/accel button. Hold it there until you get up to the speed you want, and then release the button. To increase your speed in very small amounts, press the button briefly. Each time you do this, your vehicle will go about 1 mph (1.6 km/h) faster.

Reducing Speed While Using Cruise Control

There are two ways to reduce your speed while using cruise control:

- Press set/coast button until you reach the lower speed you want, then release it.
- To slow down in very small amounts, briefly press the set/coast button. Each time you do this, you will go about 1 mph (1.6 km/h) slower.

Passing Another Vehicle While Using Cruise Control

Use the accelerator pedal to increase your speed. When you take your foot off the pedal, your vehicle will slow down to the cruise control speed you set earlier.

Using Cruise Control on Hills

How well your cruise control will work on hills depends upon your speed, load and the steepness of the hills. When going up steep hills, you may have to step on the accelerator pedal to maintain your speed. When going downhill, you may have to brake or shift to a lower gear to keep your speed down. Applying the brake or shifting into a lower gear will take you out of cruise control. If you need to apply the brake or shift to a lower gear due to the grade of the downhill slope, you may not want to attempt to use your cruise control feature.

Ending Cruise Control

To end a cruise control session, step lightly on the brake pedal.

Stepping on the brake will end the current cruise control session only. Press the cruise on/off button to turn off the system completely.

Erasing Speed Memory

When you turn off the cruise control or the ignition, your cruise control set speed memory is erased.

Exterior Lamps

Headlamps

See *Turn Signal/Multifunction Lever on page 3-6* for more information on the headlamps.

Daytime Running Lamps

Daytime Running Lamps (DRL) can make it easier for others to see the front of your vehicle during the day. DRL can be helpful in many different driving conditions, but they can be especially helpful in the short periods after dawn and before sunset. Fully functional daytime running lamps are required on all vehicles first sold in Canada.

The DRL system will make your low-beam headlamps come on at a reduced brightness in daylight when the following conditions are met:

- The ignition is on,
- the exterior lamp band is in the AUTO position,
- the transaxle is not in PARK (P),
- the light sensor determines it is daytime, and
- the parking brake is released.

When the DRL are on, the low-beam headlamps will be on at a reduced brightness. The taillamps, sidemarker and other lamps will not be on. The instrument panel will not be lit up either.

When you turn the exterior lamp band to the headlamp position, your low-beam headlamps will come on. The other lamps that come on with your headlamps will also come on.

When you turn off the headlamps, the regular lamps will go off, and your low-beam headlamps will come on to the reduced brightness.

To idle your vehicle with the DRL off, move the shift lever to PARK (P). The DRL will stay off until you move the shift lever out of PARK (P).

As with any vehicle, you should turn on the regular headlamp system when you need it.

Automatic Headlamp System

When it is dark enough outside, the headlamps will come on automatically.



Your vehicle has a light sensor located on top of the instrument panel. Make sure it is not covered, or the headlamps will be on when you don't need them.

The system may also turn on the headlamps when driving through a parking garage or tunnel.

Fog Lamps

If your vehicle has this feature, use your fog lamps for better visibility in foggy or misty conditions.



The button for your fog lamps is located in the instrument panel above the radio.

Push the button to turn the fog lamps on or off.

When using fog lamps, the parking lamps or low-beam headlamps must be on.

A light on the button will come on when the fog lamps are actually on. Fog lamps will go off whenever the high-beam headlamps come on. When the high-beam headlamps go off, the fog lamps will come on again.

Interior Lamps

Instrument Panel Brightness

This feature controls the brightness of the instrument panel lights.



The thumbwheel for this feature is located on the instrument panel to the left of the steering column.

Turn the thumbwheel up to brighten the lights or down to dim them.

Entry Lighting

If the dome lamp is in the DOOR position, the lamps inside your vehicle will come on when any door is opened. In addition, the light will come on when the remote keyless entry unlock button is pressed. It will stay on for 20 seconds or until a door is opened. After the door is opened the light will remain on and stay on for 20 seconds after the doors are closed, or until you put the key in the ignition and turn the key to RUN. The light will then gradually dim until it is no longer lit.

Dome Lamp

The dome lamp switch has three positions.

ON: The lamp will stay on as long as the switch is in this position.

DOOR: The lamp will come on when a door is opened. See "Entry Lighting" for more information.

OFF: The lamp will not come on as long as the switch is in this position.

Map Lamps

Your vehicle may have map lamps on the rearview mirror. Press the button next to the lamp to turn it on and off.

Battery Run-Down Protection

Your vehicle is equipped with a battery saver feature designed to protect your vehicle's battery.

When any interior lamp is left on and the ignition is turned off, the battery rundown protection system will automatically turn the lamp off after 20 minutes.

Accessory Power Outlets

The accessory power outlets can be used to connect electrical equipment such as a cellular phone or CB radio.

The accessory power outlets are located in the front and rear of the center console.

To use the outlet, remove the cover. When not in use, always cover the outlet with the protective cap.

Notice: Leaving electrical equipment on for extended periods will drain the battery. Always turn off electrical equipment when not in use and do not plug in equipment that exceeds the maximum amperage rating.

Certain electrical accessories may not be compatible with the accessory power outlet and could result in blown vehicle or adapter fuses. If you experience a problem, see your dealer for additional information on the accessory power outlet.

Notice: Adding any electrical equipment to your vehicle may damage it or keep other components from working as they should. The repairs would not be covered by your warranty. Check with your dealer before adding electrical equipment.

When adding electrical equipment, be sure to follow the installation instructions included with the equipment.

Notice: Improper use of the power outlet can cause damage not covered by your warranty. Do not hang any type of accessory or accessory bracket from the plug because the power outlets are designed for accessory power plugs only.

Ashtrays and Cigarette Lighter

Your vehicle may have an ashtray and cigarette lighter. To use the lighter, just push it in all the way and let go. When it's ready, it will pop back out by itself.

Notice: Holding a cigarette lighter in while it is heating will not allow the lighter to back away from the heating element when it is hot. Damage from overheating may occur to the lighter or heating element, or a fuse could be blown. Do not hold a cigarette lighter in while it is heating.

To remove the ashtray, lift it straight up. To reinstall it, press the ashtray down firmly until it is fully seated.

Notice: If you put papers or other flammable items in the ashtray, hot cigarettes or other smoking materials could ignite them and possibly damage your vehicle. Never put flammable items in the ashtray.

Climate Controls

Climate Control System

With this system you can control the heating, cooling and ventilation for your vehicle.



Operation

To change the current mode, turn the right knob to select one of the following:

 **(Vent):** This mode directs air to the instrument panel outlets.

 **(Bi-Level):** This mode directs half of the air to the instrument panel outlets, and then directs most of the remaining air to the floor outlets. Some air may be directed toward the side windows.

 **(Floor):** This mode directs most of the air to the floor outlets with some air directed to the side window outlets.

The right knob can also be used to select defog or defrost modes. Information on defogging and defrosting can be found later in this section.

 **(Fan):** Turn the knob in the center of the system clockwise or counterclockwise to increase or decrease the fan speed. The fan must be on to run the air-conditioning compressor.

Temperature Control: Turn the left knob clockwise or counterclockwise to increase or decrease the temperature inside your vehicle.

 **(Recirculation):** This mode keeps outside air from coming in the vehicle. It can be used to prevent outside air and odors from entering your vehicle or to help cool the air inside your vehicle more quickly. Press this button to turn the recirculation mode on or off. When the button is pressed, an indicator light above the button will come on to let you know that it is activated. The air-conditioning compressor comes on. The recirculation mode can be used with vent, bi-level, or floor modes, but it cannot be used with the defog or defrost modes. When you switch to the defog or defrost modes the system will automatically move from recirculation to outside air. When you move the mode knob back to another mode, the system will move back into recirculation. When the car is turned off and back on the system will default to outside air automatically.

AC (Air Conditioning): Press this button to turn the air-conditioning system on or off. When A/C is pressed, an indicator light above the button will come on to let you know that air conditioning is activated.

On hot days, open the windows to let hot inside air escape; then close them. This helps to reduce the time it takes for your vehicle to cool down. It also helps the system to operate more efficiently.

For quick cool down on hot days, do the following:

1. Select the vent mode.
2. Select the highest fan speed.
3. Select A/C.
4. Select the recirculation mode.
5. Select the coolest temperature.

Using these settings together for long periods of time may cause the air inside of your vehicle to become too dry. To prevent this from happening, after the air in your vehicle has cooled, turn the recirculation mode off.

The air-conditioning system removes moisture from the air, so you may sometimes notice a small amount of water dripping underneath your vehicle while idling or after turning off the engine. This is normal.

Defogging and Defrosting

Fog on the inside of windows is a result of high humidity (moisture) condensing on the cool window glass. This can be minimized if the climate control system is used properly. There are two modes to choose from to clear fog or frost from your windshield. Use the defog mode to clear the windows of fog or moisture and warm the passengers. Use the defrost mode to remove fog or frost from the windshield more quickly.

Turn the right knob to select the defog or defrost mode.

 **(Defog):** This mode directs half of the air to the windshield and half to the floor outlets with a small amount directed to the side windows. When you select this mode, the system turns off recirculation automatically and runs the air-conditioning compressor unless the outside temperature is at or below freezing. The recirculation mode cannot be selected while in the defog mode. Do not drive the vehicle until all the windows are clear.

 **(Defrost):** This mode directs most of the air to the windshield with some air directed to the floor vents. In this mode, the system will automatically force outside air into your vehicle and run the air-conditioning compressor. Recirculation cannot be selected while in the defrost mode.

Rear Window Defogger

The rear window defogger uses a warming grid to remove fog or frost from the rear window.

 **REAR:** Press this button to turn the rear window defogger on or off. An indicator light above the button will come on to let you know that the rear window defogger is activated. Be sure to clear as much snow from the rear window as possible.

The rear window defogger will turn off approximately 15 minutes after the button is pressed. If turned on again, the defogger will only run for approximately seven minutes before turning off. The defogger can also be turned off by pressing the button again or by turning off the engine.

If your vehicle has heated outside mirrors, the mirrors will also heat when the rear defogger is on. See *Outside Heated Mirrors* on page 2-39 for more information.

Notice: Don't use anything sharp on the inside of the rear window. If you do, you could cut or damage the warming grid, and the repairs wouldn't be covered by your warranty. Do not attach a temporary vehicle license, tape, a decal or anything similar to the defogger grid.

Automatic Climate Control System

If your vehicle has this system, you can control the heating, cooling and ventilation in your vehicle automatically.



Automatic Operation

To switch the temperature display from degrees Fahrenheit to degrees Celsius, press and hold the AUTO, ECON, and MODE buttons at the same time.

AUTO (Automatic): When automatic operation is active the system will control the inside temperature, the air delivery, and the fan speed.

OFF: Press this button to turn off the entire climate control system. Outside air will still enter the vehicle.

Use the steps below to place the entire system in automatic mode:

1. Put the fan knob on AUTO and press the AUTO button.

When AUTO is selected, the display will change to show the current set temperature, delivery mode and fan speed.

When auto is selected, the air conditioning operation and air inlet will be automatically controlled. The air conditioning compressor will run when as necessary. The air inlet will normally be set to outside air. If it's hot outside, the air inlet may automatically switch to recirculate inside air to help quickly cool down your vehicle. The light on the button will illuminate in recirculation.

2. Set the temperature.

To find your comfort setting, start with a 71°F (22°C) temperature setting and allow about two to three minutes for the system to regulate. Turn the temperature knob to adjust the temperature setting as necessary. If you choose the temperature setting of 60°F (15°C) the system will remain at the maximum cooling setting. If you choose the temperature setting of 90°F (32°C) the system will remain at the maximum heat setting. Choosing either maximum setting will not cause the vehicle to heat or cool any faster.

Be careful not to cover the sensor located on the top of the instrument panel near the windshield. This sensor regulates air temperature based on sun load, and also turns on your headlamps. See "Sensor" later in this section for more information.

To avoid blowing cold air in cold weather, the system will delay turning on the fan until warm air is available. The length of delay depends on the engine coolant temperature. Pressing the fan switch will override this delay and change the fan to a selected speed.

Manual Operation

You may manually adjust the air delivery mode or fan speed.

OFF: Press this button to turn off the entire climate control system. Outside air will still enter the vehicle.

 **(Fan):** The knob with the fan symbol allows you to manually adjust the fan speed. Turn it clockwise and counterclockwise to increase and decrease the fan speed. If the fan knob is on AUTO the system will automatically control the fan speed.

MODE: Press this button to manually change the direction of the airflow in your vehicle; keep pressing the button until the desired mode appears on the display.

Select from the following modes:

 **(Vent):** This setting will deliver air to the instrument panel outlets.

 **(Bi-Level):** This setting will deliver warmer air to the floor and cooler air to the instrument panel outlets.

 **(Floor):** This setting will deliver air to the floor outlets.

For information on the defog and defrost modes see “Defogging and Defrosting” later in this section.

 **(Recirculation):** Press this button to limit the amount of outside air entering your vehicle. The light on the recirculation button will glow. This is helpful when you are trying to limit odors entering your vehicle and for maximum air conditioning performance in hot weather. Press this button again to allow outside air to enter the vehicle. The light on the recirculation button will go off.

If you select recirculation while in defrost or defog, the system will not switch to that mode. This is to prevent fogging.

When the weather is cool or damp, operating the system in recirculation for extended periods of time may cause fogging of the vehicle’s windows. To clear the fog, select either defog or front defrost. The air conditioning compressor will run automatically to help dehumidify the air.

ECON: Pressing this button will disable the air conditioning compressor. A/C OFF will be displayed on the screen. Press the button again to allow for automatic operation of the air conditioning compressor.

Sensor



A sensor located on top of the instrument panel is used by the automatic climate control system to adjust the automatic operation of the system. Do not cover this sensor.

Defogging and Defrosting

You can use either defog or front defrost to clear fog or frost from your windshield. Use the defog mode to clear the windows of fog or moisture. Use the front defrost button to defrost the front windshield.

 **(Defog):** Use this setting to clear the windows of fog or moisture. Press the mode button to select this setting. This setting will deliver air to the floor and windshield outlets. The air conditioning compressor will automatically run to help dehumidify the air and dry the windshield.

 **(Defrost):** Press the front defrost button to defrost the windshield and side windows. The air conditioning compressor will automatically run to help dehumidify the air and dry the windshield. To turn defrost off, press the AUTO or MODE button.

Rear Window Defogger

The rear window defogger uses a warming grid to remove fog from the rear window.

 **(Rear):** Press this button to turn the rear window defogger on or off. An indicator light in the button will come on to let you know that the rear window defogger is activated.

The rear window defogger will turn off approximately 15 minutes after the button is pressed. If you need additional warming time, press the button again.

If your vehicle is equipped with heated mirrors this button will activate them.

Notice: Using a razor blade or sharp object to clear the inside rear window may damage the rear window defogger. Repairs would not be covered by your warranty. Do not clear the inside of the rear window with sharp objects.

Outlet Adjustment

Use the louvers located on the air outlets to change the direction of the airflow.

Operation Tips

- Clear away any ice, snow or leaves from the air inlets at the base of the vehicle that may block the flow of air into your vehicle.
- Use of non-GM approved hood deflectors may adversely affect the performance of the system.
- Keep the path under the front seats clear of objects to help circulate the air inside of your vehicle more effectively.

Passenger Compartment Air Filter

Your vehicle may be equipped with a passenger compartment air filter. It is located underneath the hood just below the windshield wiper arm on the passenger's side of the vehicle.

The filter traps most of the pollen from air entering the Climate Control System. Like your engine's air cleaner/filter, it may need to be changed periodically to insure system performance. For information on how often to change the passenger compartment air filter, see *Scheduled Maintenance on page 6-4*.

For the type of filter to use, see *Normal Maintenance Replacement Parts on page 6-13*.

To change the passenger compartment air filter, use the following steps:

1. Open the hood. Locate the passenger compartment air filter access panel.
2. Peel back the hood weatherstrip from the passenger's side of the vehicle halfway to center.



3. Use a tool to open the passenger compartment air filter access door.
4. Remove any leaves or other debris from the filter area.



5. Release the two locking tabs and pull the filter out.
6. Reverse the steps to install the new air filter.

Warning Lights, Gages, and Indicators

This part describes the warning lights and gages that may be on your vehicle. The pictures will help you locate them.

Warning lights and gages can signal that something is wrong before it becomes serious enough to cause an expensive repair or replacement. Paying attention to your warning lights and gages could also save you or others from injury.

Warning lights come on when there may be or is a problem with one of your vehicle's functions. As you will see in the details on the next few pages, some warning lights come on briefly when you start the engine just to let you know they're working. If you are familiar with this section, you should not be alarmed when this happens.

Gages can indicate when there may be or is a problem with one of your vehicle's functions. Often gages and warning lights work together to let you know when there's a problem with your vehicle.

When one of the warning lights comes on and stays on when you are driving, or when one of the gages shows there may be a problem, check the section that tells you what to do about it. Please follow this manual's advice. Waiting to do repairs can be costly — and even dangerous. So please get to know your warning lights and gages. They're a big help.

Instrument Panel Cluster

The instrument cluster is designed to let you know at a glance how the vehicle is running. You will know how fast you are going, about how much fuel you have used, and many other things you will need to know to drive safely and economically.

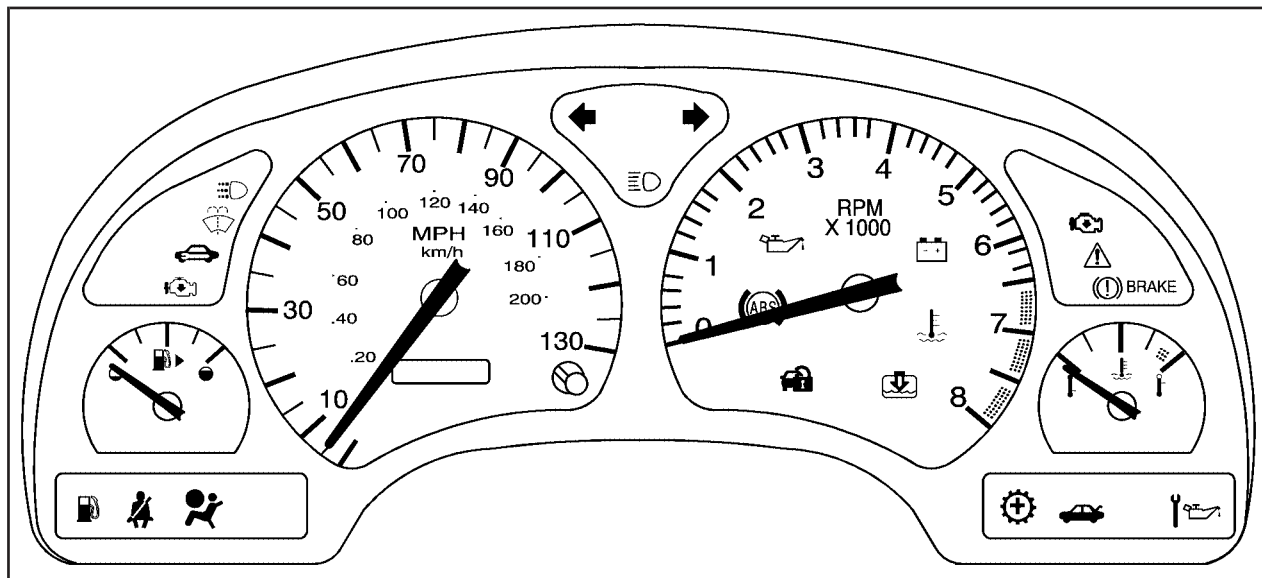

Speedometer and Odometer

Your speedometer lets you see your speed in both miles per hour (mph) and kilometers per hour (km/h).

Your odometer shows how far your vehicle has been driven, in either miles or kilometers.

Your vehicle has a tamper-resistant odometer. You may wonder what happens if your vehicle needs a new odometer installed. If the new one can be set to the mileage total of the old odometer, then that will be done. If it can't, it will be set at zero and a label must be put on the driver's door to show the old mileage reading when the new odometer was installed. If the mileage is unknown, the label should then indicate "previous mileage unknown".

Trip Odometer

Your trip odometer shows how far your vehicle has been driven since the trip odometer was last reset. To reset the trip odometer to zero, press and hold the trip/reset button for about two seconds.

Tachometer

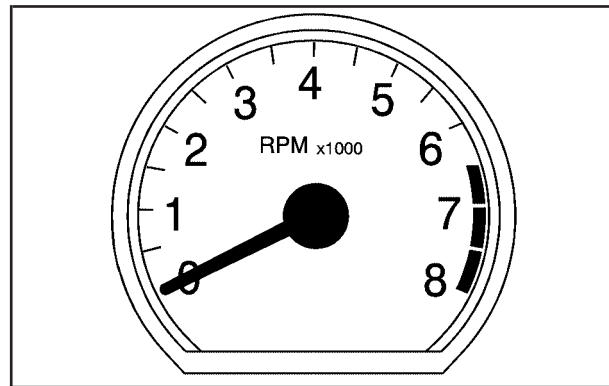

The tachometer displays the engine speed in revolutions per minute (rpm).

Notice: If you operate the engine with the tachometer in the shaded warning area, your vehicle could be damaged, and the damages would not be covered by your warranty. Do not operate the engine with the tachometer in the shaded warning area.

The maximum rpm is limited in PARK (P) and NEUTRAL (N) to 4000 rpm by the vehicle's computer. This is to prevent engine damage.

Safety Belt Reminder Light

When the key is turned to RUN or START, a chime will come on for several seconds to remind people to fasten their safety belts, unless the driver's safety belt is already buckled.



The safety belt light will also come on and stay on for several seconds, then it will flash for several more.

If the driver's belt is already buckled, neither the chime nor the light will come on.

Air Bag Readiness Light

There is an air bag readiness light on the instrument panel, which shows the air bag symbol. The system checks the air bag's electrical system for malfunctions. The light tells you if there is an electrical problem. The system check includes the air bag sensor, the air bag modules, the wiring and the crash sensing and diagnostic module. For more information on the air bag system, see *Air Bag Systems on page 1-62*.

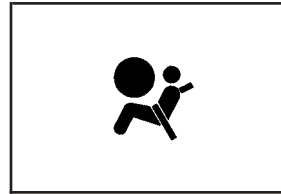

This light will come on when you start your vehicle, and it will flash for a few seconds. Then the light should go out. This means the system is ready.

If the air bag readiness light stays on after you start the vehicle or comes on when you are driving, your air bag system may not work properly. Have your vehicle serviced right away.

CAUTION:

If the air bag readiness light stays on after you start your vehicle, it means the air bag system may not be working properly. The air bags in your vehicle may not inflate in a crash, or they could even inflate without a crash. To help avoid injury to yourself or others, have your vehicle serviced right away if the air bag readiness light stays on after you start your vehicle.

The air bag readiness light should flash for a few seconds when you turn the ignition key to RUN. If the light doesn't come on then, have it fixed so it will be ready to warn you if there is a problem.

Battery Warning Light

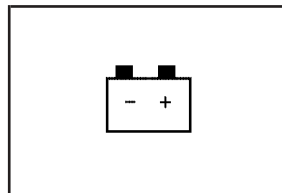

The battery warning light will come on briefly as a check, when you turn on the ignition. Then it should go out when the engine is started.

If the light does not come on when you start your vehicle, have your vehicle serviced right away. This condition may indicate your battery warning light is not functioning properly. If this light comes on while you are driving, be sure to turn off accessories such as the radio and climate control system. Have your vehicle serviced right away.

Brake System Warning Light

Your vehicle's hydraulic brake system is divided into two parts. If one part isn't working, the other part can still work and stop you. For good braking, though, you need both parts working well.

If the brake system warning light comes on, there is a brake problem. Have your brake system inspected right away.



The BRAKE light is located in the instrument panel cluster.

This light should come on briefly when you turn the ignition key to RUN. If it doesn't come on then, have it fixed so it will be ready to warn you if there's a problem.

When the ignition is on, the BRAKE light will come on when you set your parking brake. The light will stay on if your parking brake doesn't release fully.

A chime will also sound if the parking brake is not fully released and the vehicle is moving. If it stays on after your parking brake is fully released, it means you have a brake problem.

The BRAKE light will also come on to indicate a low brake fluid level. See *Brakes* on page 5-36 for more information.

If the light comes on while you are driving, pull off the road and stop carefully. You may notice that the pedal is harder to push. Or, the pedal may go closer to the floor. It may take longer to stop. If the light is still on, have the vehicle towed for service. See *Towing Your Vehicle* on page 4-32.

CAUTION:

Your brake system may not be working properly if the brake system warning light is on. Driving with the brake system warning light on can lead to an accident. If the light is still on after you have pulled off the road and stopped carefully, have the vehicle towed for service.

Anti-Lock Brake System Warning Light

If your vehicle has anti-lock brakes, the anti-lock brake system (ABS) warning light will come on briefly, as a check, when you start your vehicle. If it does not, have your vehicle serviced so that the light works properly when it needs to.

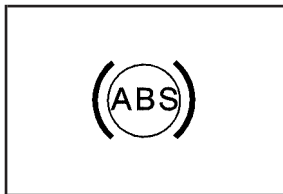

The ABS light is located in the instrument panel cluster, to the left of the engine coolant temperature gage.

If the light stays on longer than a few seconds after you start your engine, or comes on and stays on while you are driving, try resetting the system.

To reset the system, do the following:

1. If you are driving, pull over when it is safe to do so.
2. Be sure the vehicle is in PARK (P).
3. Turn off the ignition.
4. Then restart the engine.

If the light remains on after resetting the system or comes on again while driving, your vehicle needs service. If the ABS light is on, but the regular brake system warning light is not on, you do not have anti-lock brakes, but you still have regular brakes. Have your vehicle serviced right away. If both brake lights are on, you do not have anti-lock brakes, and there's a problem with your regular brakes as well. Have your vehicle towed for service. See *Towing Your Vehicle on page 4-32*.

Traction Control System (TCS) Warning Light



The Traction Control System (TCS) light will come on when the system is limiting wheel spin.

You may feel or hear the system working, but this is normal. The roads may be slippery if this light comes on. Adjust your driving accordingly.

The light will stay on for a few seconds after the system stops limiting wheel spin. This light should also come on for a few seconds when you start your vehicle. If it does not, have your vehicle serviced.

Engine Coolant Temperature Warning Light

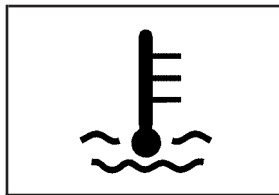

The engine coolant temperature warning light will come on when the engine has overheated.

If this happens you should pull over and turn off the engine as soon as possible. See *Engine Overheating on page 5-26* for more information.

Notice: Driving with the engine coolant temperature warning light on could cause your vehicle to overheat. See “Engine Overheating” under *Engine Coolant on page 5-23*. Your vehicle could be damaged, and it might not be covered by your warranty. Never drive with the engine coolant temperature warning light on.

This light will also come on when starting your vehicle. If it doesn't, have your vehicle serviced.

Engine Coolant Temperature Gage

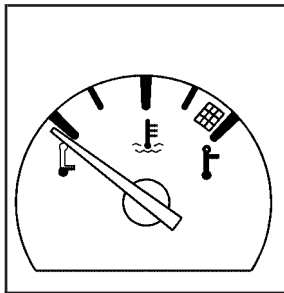

This gage measures the temperature of the vehicle's engine. If the indicator needle moves into the shaded area, the engine is too hot. A temperature indicator light will turn on and a chime will sound.

If you have been operating your vehicle under normal driving conditions, and the temperature indicator light comes on, you should pull off the road, stop your vehicle and turn off the engine as soon as possible.

Low Coolant Warning Light

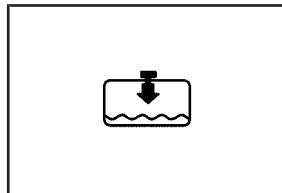

This light comes on briefly when you turn your ignition on.

If this light comes on and stays on, the coolant level in your vehicle is low. If the light is on along with an overheat warning, you may have a serious overheating problem. See *Engine Coolant Temperature Gage* on page 3-33.

Notice: Driving with the low coolant warning light on could cause your vehicle to overheat. See “Engine Overheating” under *Engine Coolant* on page 5-23. Your vehicle could be damaged and the damages might not be covered by your warranty.

See *Engine Coolant* on page 5-23 for information on what to do. Your vehicle should be serviced as soon as possible.

Malfunction Indicator Lamp

Service Engine Soon Light

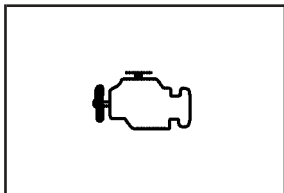

Your vehicle is equipped with a computer which monitors operation of the fuel, ignition and emission control systems.

This system is called OBD II (On-Board Diagnostics-Second Generation) and is intended to assure that emissions are at acceptable levels for the life of the vehicle, helping to produce a cleaner environment. The SERVICE ENGINE SOON light comes on to indicate that there is a problem and service is required. Malfunctions often will be indicated by the system before any problem is apparent. This may prevent more serious damage to your vehicle. This system is also designed to assist your service technician in correctly diagnosing any malfunction.

Notice: If you keep driving your vehicle with this light on, after a while, your emission controls may not work as well, your fuel economy may not be as good and your engine may not run as smoothly. This could lead to costly repairs that may not be covered by your warranty.

Notice: Modifications made to the engine, transaxle, exhaust, intake or fuel system of your vehicle or the replacement of the original tires with other than those of the same Tire Performance Criteria (TPC) can affect your vehicle's emission controls and may cause this light to come on. Modifications to these systems could lead to costly repairs not covered by your warranty. This may also result in a failure to pass a required Emission Inspection/Maintenance test.

This light should come on, as a check to show you it is working, when the ignition is on and the engine is not running. If the light does not come on, have it repaired. This light will also come on during a malfunction in one of two ways:

- **Light Flashing** — A misfire condition has been detected. A misfire increases vehicle emissions and may damage the emission control system on your vehicle. Diagnosis and service may be required.
- **Light On Steady** — An emission control system malfunction has been detected on your vehicle. Diagnosis and service may be required.

If the Light Is Flashing

The following may prevent more serious damage to your vehicle:

- Reducing vehicle speed.
- Avoiding hard accelerations.
- Avoiding steep uphill grades.
- If you are towing a trailer, reduce the amount of cargo being hauled as soon as it is possible.

If the light stops flashing and remains on steady, see “If the Light Is On Steady” following.

If the light continues to flash, when it is safe to do so, *stop the vehicle*. Find a safe place to park your vehicle. Turn the key off, wait at least 10 seconds and restart the engine. If the light remains on steady, see “If the Light Is On Steady” following. If the light is still flashing, follow the previous steps, and see your retailer for service as soon as possible.

If the Light Is On Steady

You may be able to correct the emission system malfunction by considering the following:

Did you recently put fuel into your vehicle?

If so, reinstall the fuel cap, making sure to fully install the cap. See *Filling Your Tank on page 5-8*. The diagnostic system can determine if the fuel cap has been left off or improperly installed. A loose or missing fuel cap will allow fuel to evaporate into the atmosphere. A few driving trips with the cap properly installed should turn the light off.

Did you just drive through a deep puddle of water?

If so, your electrical system may be wet. The condition will usually be corrected when the electrical system dries out. A few driving trips should turn the light off.

Have you recently changed brands of fuel?

If so, be sure to fuel your vehicle with quality fuel. See *Gasoline Octane on page 5-5*. Poor fuel quality will cause your engine not to run as efficiently as designed. You may notice this as stalling after start-up, stalling when you put the vehicle into gear, misfiring, hesitation on acceleration or stumbling on acceleration. (These conditions may go away once the engine is warmed up.) This will be detected by the system and cause the light to turn on.

If you experience one or more of these conditions, change the fuel brand you use. It will require at least one full tank of the proper fuel to turn the light off.

If none of the above steps have made the light turn off, your retailer can check the vehicle. Your retailer has the proper test equipment and diagnostic tools to fix any mechanical or electrical problems that may have developed.

Emissions Inspection and Maintenance Programs

Some state/provincial and local governments have or may begin programs to inspect the emission control equipment on your vehicle. Failure to pass this inspection could prevent you from getting a vehicle registration.

Here are some things you need to know in order to help your vehicle pass an inspection:

Your vehicle will not pass this inspection if the SERVICE ENGINE SOON light is on or not working properly.

Your vehicle will not pass this inspection if the OBD (on-board diagnostic) system determines that critical emission control systems have not been completely diagnosed by the system. The vehicle would be considered not ready for inspection. This can happen if you have recently replaced your battery or if your battery has run down. The diagnostic system is designed to evaluate critical emission control systems during normal driving. This may take several days of routine driving. If you have done this and your vehicle still does not pass the inspection for lack of OBD system readiness, your retailer can prepare the vehicle for inspection.

Oil Pressure Light

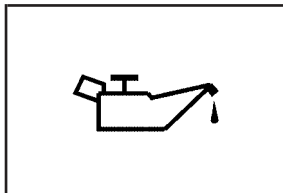

If you have a low engine oil pressure problem, this light will stay on after you start your engine, or come on when you are driving. This indicates that your engine is not receiving enough oil.

The engine could be low on oil, or could have some other oil problem. Have it fixed immediately.

The oil light may also come on when the ignition is on but the engine is not running, the light will come on as a test to show you it is working, but the light will go out when you turn the ignition to START. If it doesn't come on with the ignition on, you may have a problem with the fuse or bulb. Have it fixed right away.

CAUTION:

Do not keep driving if the oil pressure is low. If you do, your engine can become so hot that it catches fire. You or others could be burned. Check your oil as soon as possible and have your vehicle serviced.

Notice: Lack of proper engine oil maintenance may damage the engine. The repairs would not be covered by your warranty. Always follow the maintenance schedule in this manual for changing engine oil.

Change Engine Oil Light

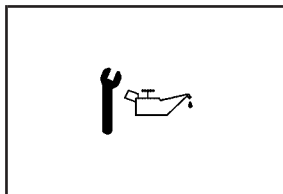

If this light comes on and stays on, it means that service is required for your vehicle.

See *Scheduled Maintenance on page 6-4 Engine Oil on page 5-16* for more information.

Security Light

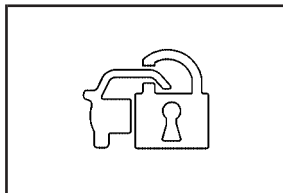

Your vehicle is equipped with a Passlock[®] theft-deterrent system. With this system, the security light will flash as you open the door if your ignition is off.

For more information, see *Passlock[®] on page 2-18*.

Reduced Engine Power Light

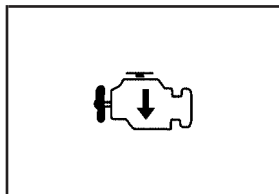

This light will come on briefly when you start the engine.

This light is displayed when a noticeable reduction in the vehicle's performance may occur. Stop the vehicle and turn off the ignition. Wait for 10 seconds and restart your vehicle. This may correct the condition.

The vehicle may be driven at a reduced speed when the reduced engine power light is on but acceleration and speed may be reduced. The performance may be reduced until the next time you drive your vehicle. If this light stays on, see your retailer as soon as possible for diagnosis and repair.

Daytime Running Lamps Indicator Light

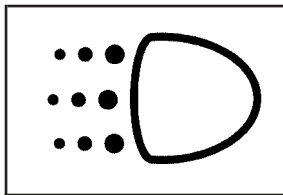

This light is located on the instrument panel cluster. It goes on whenever the Daytime Running Lamps are on.

See *Daytime Running Lamps* under *Exterior Lamps* on page 3-13 for further information.

Low Washer Fluid Warning Light



This light will come on when your vehicle is low on windshield washer fluid.

For more information, see *Windshield Washer Fluid* on page 5-35.

Trunk Ajar Light

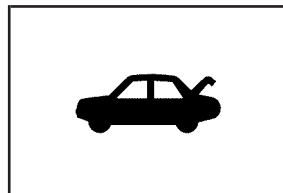

If this light comes on, your trunk or liftgate is ajar. Try closing the trunk or liftgate again. Never drive with the trunk or liftgate open.

Service Vehicle Soon Light

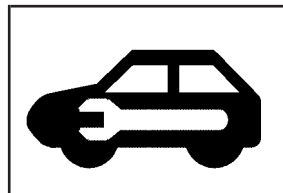

This light will come on if you have certain non-emission related vehicle problems.

Take your vehicle in for service as soon as possible.

Fuel Gage

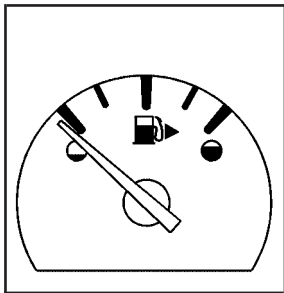

When the ignition is on, the fuel gage tells you about how much fuel you have left in your tank.

When the indicator nears empty, the low fuel light will come on. You still have a little fuel left, but you should get more soon. See *Low Fuel Warning Light* on page 3-40 for more information.

Here are four things that some owners ask about. None of these show a problem with your fuel gage:

- At the service station, the fuel pump shuts off before the gage reads full.
- It takes a little more or less fuel to fill up than the gage indicated. For example, the gage may have indicated the tank was half full, but it actually took a little more or less than half the tank's capacity to fill the tank.

- The gage moves a little when you turn a corner or speed up.
- The gage takes a few seconds to stabilize after the ignition is turned on, and will go back to empty when you turn the ignition off.

For your fuel tank capacity, see *Capacities and Specifications* on page 5-98.

Low Fuel Warning Light

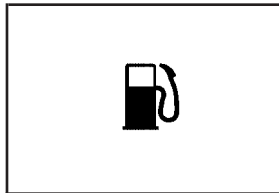

The light next to the fuel gage will come on briefly when you are starting the engine.

This light also comes on when the fuel tank is low on fuel. When you add fuel the light should go off. If it doesn't, have your vehicle serviced.

Audio System(s)

Notice: Before adding any sound equipment to your vehicle, like a tape player, CB radio, mobile telephone, or two-way radio, make sure that it can be added by checking with your dealer. Also, check federal rules covering mobile radio and telephone units. If sound equipment can be added, it is very important to do it properly. Added sound equipment may interfere with the operation of your vehicle's engine, radio, or other systems, and even damage them. Your vehicle's systems may interfere with the operation of sound equipment that has been added improperly.

Notice: Getting suntan lotion, hand lotion, or hand cleaner on the radio, will soften the paint, and the paint will eventually begin to peel. Repairs will not be covered by your vehicle's warranty. Try not to get suntan lotion, hand lotion, or hand cleaner on the radio. If you do, wipe the lotion or cleaner off immediately.

Figure out which audio system is in your vehicle, find out what your audio system can do, and how to operate all of its controls.

Setting the Time

Press and hold the RCL button and at the same time press the HR arrow or the MIN arrow until the correct hour and minute appear on the display. The time can be set with the ignition on or off.

AM-FM Radio



Playing the Radio

ON (Power): Push this knob to turn the system on and off.

VOL (Volume): Turn this knob to increase or to decrease the volume.

RCL (Recall): Press this knob to switch the display between the radio station frequency and the time. When the ignition is off, press this knob to display the time.

Finding a Station

AM FM: Press this button to switch between FM1, FM2, or AM. The display will show the selection.

▼ **TUNE** ▲: Press either arrow to select radio stations.

▼ **SEEK** ▲: Press the up or down arrow to go to the next or to the previous station and stay there.

The radio will only seek stations with a strong signal that are in the selected band.

SCN (Scan): Press this button to scan stations. The radio will go to a station, play for a few seconds, then go on to the next station. Press this button again to stop scanning.

The radio will only scan stations with a strong signal that are in the selected band.

Setting Preset Stations

Up to 18 stations (six FM1, six FM2, and six AM) can be programmed on the six numbered pushbuttons, by performing the following steps:

1. Turn the radio on.
2. Press AM FM to select FM1, FM2, or AM.
3. Tune in the desired station.
4. Press and hold one of the six numbered pushbuttons until you hear a beep. Whenever that numbered pushbutton is pressed, the station that was set will return.
5. Repeat the steps for each pushbutton.

If the battery has been disconnected or a radio fuse has been removed, the preset stations and time of day will need to be reset.

Using Automatic Set

Use this feature to automatically save the radio preset pushbuttons with the stations with the strongest radio signals.

A.SET (Automatic Set): Press this button to have the radio automatically select the first 12 strongest radio stations for FM and the six strongest radio stations for AM.

To select the stations, perform the following:

1. Press AM FM to select FM1, FM2, or AM.
2. Press and hold AM FM until you hear a beep.

The radio will begin to search the current band. The radio will store the stations, starting from the lowest frequency, to each preset pushbutton. A.SET will appear on the display when the radio is finished storing the stations.

Cancelling Automatic Set

The radio retains the previously stored stations so they can be recalled when automatic set is canceled.

Press and hold A.SET until you hear a beep. A.SET will no longer appear on the display.

Setting the Tone (Bass/Treble)

BASS: Press this knob lightly so it extends. Turn the knob to increase or to decrease the bass.

TREB (Treble): Press the BASS knob lightly so it extends, then pull then knob out slightly. Turn the knob to increase or to decrease the treble. If a station is weak or noisy, decrease the treble.

Push the knob back into it's stored position when not in use.

Adjusting the Speakers (Balance/Fade)

BAL (Balance): To adjust the balance between the right and the left speakers, pull the VOL knob out slightly. Turn the knob to move the sound toward the right or the left speakers.

Push the knob back into it's stored position when not in use.

FADE: To adjust the fade between the front and the rear speakers, turn the ring around the VOL knob.

Radio with CD



Playing the Radio

PUSH ON (Power): Press this knob to turn the system on and off.

VOL (Volume): Turn this knob to increase or to decrease volume.

RCL (Recall): Press this knob to switch the display between the radio station frequency and the time. Time display is available with the ignition turned off.

Finding a Station

AM FM: Press this button to switch between FM1, FM2, or AM. The display will show your selection.

▼ **TUNE** ▲: Press the up or down arrow to select radio stations.

▼ **SEEK** ▲: Press the up or down arrow to go to the next or to the previous station and stay there.

The radio will seek only to stations that are in the selected band and only to those with a strong signal.

SCN (Scan): Press this button to scan stations. The radio will go to a station, play for a few seconds, then go on to the next station. Press this button again to stop scanning.

The radio will scan only to stations that are in the selected band and only to those with a strong signal.

Setting Preset Stations

The six numbered pushbuttons let you return to your favorite stations. You can set up to 18 stations (six FM1, six FM2, and six AM) by performing the following steps:

1. Turn the radio on.
2. Press AM FM to select FM1, FM2, or AM.
3. Tune in the desired station.
4. Press and hold one of the six numbered pushbuttons until you hear a beep. Whenever you press that numbered pushbutton, the station you set will return.
5. Repeat the steps for each pushbutton.

If the battery has been disconnected or a radio fuse has been removed, the preset stations and time of day will need to be reset.

Using Automatic Set

Use this feature to automatically save the radio preset pushbuttons with the stations with the strongest radio signals.

A.SET (Automatic Set): Press this button to have the radio automatically select the first 12 strongest radio stations for FM and the six strongest radio stations for AM.

To select the stations, perform the following:

1. Press AM FM to select FM1, FM2, or AM.
2. Press and hold AM FM until you hear a beep.

The radio will begin to search the current band. The radio will store the stations, starting from the lowest frequency, to each preset pushbutton. A.SET will appear on the display when the radio is finished storing the stations.

Cancelling Automatic Set

The radio retains the previously stored stations so they can be recalled when automatic set is canceled.

Press and hold A.SET until you hear a beep. A.SET will no longer appear on the display.

Setting the Tone (Bass/Treble)

MODE: Press this button until BAS or TRE appears on the display. Press the plus or minus buttons to increase or to decrease. The display will show the bass or the treble level. If a station is weak or noisy, you may want to decrease the treble.

Adjusting the Speakers (Balance/Fade)

MODE: To adjust the balance between the right and the left speakers, press this button until BAL appears on the display. Press the plus or minus buttons to move the sound toward the right or the left speakers.

To adjust the fade between the front and the rear speakers, press this button until FAD appears on the display. Press the plus or minus buttons to move the sound toward the front or the rear speakers.

Playing a CD

Insert a CD partway into the slot, label side up. The player will pull it in and the CD should begin playing. The CD symbol will appear on the display. You can insert a CD with the ignition off.

If you turn off the ignition or radio with a CD in the player, it will stay in the player. When you turn on the ignition or radio, the CD will start playing where it stopped, if it was the last selected audio source.

As each new track starts to play, the track number will appear on the display.

The CD player can play the smaller 8 cm single CDs with an adapter ring. Full-size CDs and the smaller CDs are loaded in the same manner.

If playing a CD-R the sound quality may be reduced due to CD-R quality, the method of recording, the quality of the music that has been recorded, and the way the CD-R has been handled. You may experience an increase in skipping, difficulty in finding tracks and/or difficulty in loading and ejecting. If these problems occur try a known good CD.

Do not add paper labels to CDs, they could get caught in the CD player.

Do not play 3 inch CDs without a standard adapter CD.

If an error appears on the display, see "CD Messages" later in this section.

1 PRV (Previous): Press this pushbutton to go to the start of the current track if more than eight seconds have played. If you hold this pushbutton or press it more than once, the player will continue moving backward through the CD.

2 NXT (Next): Press this pushbutton to go to the next track. If you hold this pushbutton or press it more than once, the player will continue moving forward through the CD.

3 REV (Reverse): Press and hold this pushbutton to reverse quickly within a track. Release it to play the track. The display will show the elapsed time of the track.

4 FWD (Forward): Press and hold this pushbutton to advance quickly within a track. Release it to play the track. The display will show the elapsed time of the track.

5 RDM (Random): Press this pushbutton to hear the tracks in random, rather than sequential, order. RDM will appear on the display. Press RDM again to turn off random play.

6 RPT (Repeat): Press this pushbutton to hear a track over again. RPT will appear on the display. The current track will continue to repeat. Press RPT again to turn off repeat play.

▲ TUNE SEEK ▼ : Press the up arrow to go to the start of the current or of the previous track. Press the down arrow to go to the start of the next track. If you hold either arrow or press it more than once, the player will continue moving backward or forward through the CD.

RCL (Recall): Press this button to see the track number. Press this button again to see how long the current track has been playing.

AM FM: Press this button to listen to the radio when a CD is playing. The inactive CD will remain safely inside the radio for future listening.

CD: Press this button to play a CD when listening to the radio. The CD symbol will appear on the display when a CD is loaded.

EJ (Eject): Press this button to eject a CD. Eject may be activated with either the ignition or radio off.

CD Messages

If ERR appears on the display and the CD comes out, it could be for one of the following reasons:

- It is very hot. When the temperature returns to normal, the CD should play.
- You are driving on a very rough road. When the road becomes smooth, the CD should play.
- The CD is dirty, scratched, wet, or upside down.
- The air is very humid. If so, wait about an hour and try again.
- There may have been a problem while burning the CD.
- The label may be caught in the CD player.

If the CD is not playing correctly, for any other reason, try a known good CD.

If any error occurs repeatedly or if an error cannot be corrected, contact your retailer. If your radio displays an error message, write it down and provide it to your retailer when reporting the problem.

Radio with Cassette and CD



Single CD Player Audio System Shown — Six-CD
CD Player Similar

Playing the Radio

PUSH ON (Power): Press this knob to turn the system on and off.

VOL (Volume): Turn this knob to increase or to decrease volume.

RCL (Recall): Press this knob to switch the display between the radio station frequency and the time. Time display is available with the ignition turned off.

Finding a Station

AM FM: Press this button to switch between FM1, FM2, or AM. The display will show your selection.

▼ TUNE ▲: Press the up or down arrow to select radio stations.

▼ SEEK SCAN ▲: Press the up or down arrow to go to the next or to the previous station and stay there.

To scan stations, press and hold either arrow until you hear a beep. SCAN will appear on the display. The radio will go to a station, play for a few seconds, then go on to the next station. Press either arrow again to stop scanning.

The radio will seek and scan only to stations that are in the selected band and only to those with a strong signal.

Setting Preset Stations

The six numbered pushbuttons let you return to your favorite stations. You can set up to 18 stations (six FM1, six FM2, and six AM) by performing the following steps:

1. Turn the radio on.
2. Press AM FM to select FM1, FM2, or AM.
3. Tune in the desired station.
4. Press the AUTO TONE arrow to select the equalization.
5. Press and hold one of the six numbered pushbuttons until you hear a beep. Whenever you press that numbered pushbutton, the station you set will return and the equalization that you selected will be automatically stored for that pushbutton.
6. Repeat the steps for each pushbutton.

If the battery has been disconnected or a radio fuse has been removed, the preset stations and time of day will need to be reset.

Using Automatic Set

Use this feature to automatically save the radio preset pushbuttons with the stations with the strongest radio signals.

A.SET (Automatic Set): Press this button to have the radio automatically select the first 12 strongest radio stations for FM and the six strongest radio stations for AM.

To select the stations, perform the following:

1. Press AM FM to select FM1, FM2, or AM.
2. Press and hold AM FM until you hear a beep.

The radio will begin to search the current band.

The radio will store the stations, starting from the lowest frequency, to each preset pushbutton. A.SET will appear on the display when the radio is finished storing the stations.

Cancelling Automatic Set

The radio retains the previously stored stations so they can be recalled when automatic set is canceled.

Press and hold A.SET until you hear a beep. A.SET will no longer appear on the display.

Setting the Tone (Bass/Treble)

BASS/TREB (Treble): Press and release this knob until BASS or TREB appears on the display. Turn the knob to increase or to decrease. The display will show the bass or the treble level. If a station is weak or noisy, you may want to decrease the treble.

▼ **AUTO TONE** ▲ (Automatic Tone): Press either arrow to select customized equalization settings designed for country/western, jazz, news, pop, rock, and classical. There is also a flat setting that has been factory tuned for the best overall performance.

To return the bass and treble to the manual mode, press either arrow until CSTM is displayed.

Adjusting the Speakers (Balance/Fade)

FADE/BAL (Balance): To adjust the balance between the right and the left speakers, press and release this knob until BAL appears on the display. Turn the knob to move the sound toward the right or the left speakers.

To adjust the fade between the front and the rear speakers, press and release this knob until FADE appears on the display. Turn the knob to move the sound toward the front or the rear speakers.

Playing a Cassette Tape

Your tape player is built to work best with tapes that are up to 30 to 45 minutes long on each side. Tapes longer than that are so thin they may not work well in this player. The longer side with the tape visible should face to the right. If the ignition is on, the tape can be inserted and will begin playing. The tape symbol will appear on the display whenever a tape is inserted. If you hear nothing but a garbled sound, the tape may not be inserted squarely. Press EJ to remove the tape and start over.

While the tape is playing, use the VOL, BASS/TREB/FADE/BAL, and AUTO TONE controls just as you do for the radio. The tape symbol will appear on the display and an arrow showing which side of the tape is playing.

If you turn off the ignition or radio with a tape in the player, it will stay in the player. When you turn on the ignition or radio, the tape will start playing where it stopped, if it was the last selected audio source.

Your tape bias is automatically set when a metal or chrome tape is inserted.

If an error appears on the display, see "Cassette Tape Messages" later in this section.

1 PREV (Previous): Press this pushbutton to go to the beginning of the current selection. Press this pushbutton again to go to the previous selection on the tape.

2 NEXT: Press this pushbutton to go to the next selection on the tape. The radio will play while the tape advances.

3 SIDE: Press this pushbutton to play the other side of the tape.

4  (Dolby®): Press this button to remove background noise. The double-D symbol will appear on the display.

Dolby® Noise Reduction is manufactured under a license from Dolby® Laboratories Licensing Corporation. Dolby® and the double-D symbol are trademarks of Dolby® Laboratories Licensing Corporation.

6 RPT (Repeat): Press this pushbutton to hear a selection over again. RPT will appear on the display. The current selection will continue to repeat. Press this pushbutton again to off repeat play.

▼ REW (Rewind): Press the down arrow to rewind quickly within the tape. Press it again to return to playing speed. The radio will play while the tape rewinds.

▲ FF (Fast Forward): Press the up arrow to advance quickly within the tape. Press it again to return to playing speed. The radio will play while the tape advances.

AM FM: Press this button to listen to the radio when a tape is playing. The inactive tape will remain safely inside the radio for future listening.

CD TP (Tape) / AUX (Auxiliary): Press this button to play a tape when listening to the radio. Press this button to switch between the tape, CD, and DVD (if equipped) if loaded. The inactive tape, CD, or DVD will remain safely inside the radio for future listening.

EJ (Eject): Press this button, located to the left of the cassette tape slot, to eject a tape. Eject may be activated with the radio off.

Cassette Tape Messages

ERR (Error): If this message appears on the display, the tape will not play because of one of the following errors.

- The tape is tight and the player cannot turn the tape hubs. Remove the tape. Hold the tape with the open end down and try to turn the right hub counterclockwise with a pencil. Turn the tape over and repeat. If the hubs do not turn easily, your tape may be damaged and should not be used in the player. Try a new tape to make sure your player is working properly.
- The tape is broken. Try a new tape.
- The tape is wrapped around the tape head. Attempt to get the cassette out. Try a new tape.

CLEAN: If this message appears on the display, the cassette tape player needs to be cleaned. It will still play tapes, but you should clean it as soon as possible to prevent damage to the tapes and player. See *Care of Your Cassette Tape Player* on page 3-72.

If any error occurs repeatedly or if an error cannot be corrected, contact your retailer. If your radio displays an error message, write it down and provide it to your retailer when reporting the problem.

CD Adapter Kits

It is possible to use a portable CD player adapter kit with your cassette tape player. Insert the adapter as you would insert a normal tape and the adapter should begin playing. The display and radio buttons will function the same.

If the adapter cassette will not play, press the SIDE pushbutton to reverse the adapter. If the adapter still will not play, refer to the directions that came with the adapter.

Playing the Single CD Player

Insert a CD partway into the slot, label side up. The player will pull it in and the CD should begin playing. The CD symbol will appear on the display. You can insert a CD with the ignition off.

If you turn off the ignition or radio with a CD in the player, it will stay in the player. When you turn on the ignition or radio, the CD will start playing where it stopped, if it was the last selected audio source.

As each new track starts to play, the track number will appear on the display.

The CD player can play the smaller 8 cm single CDs with an adapter ring. Full-size CDs and the smaller CDs are loaded in the same manner.

If playing a CD-R the sound quality may be reduced due to CD-R quality, the method of recording, the quality of the music that has been recorded, and the way the CD-R has been handled. You may experience an increase in skipping, difficulty in finding tracks and/or difficulty in loading and ejecting. If these problems occur try a known good CD.

Do not add paper labels to CDs, they could get caught in the CD player.

Do not play 3 inch CDs without a standard adapter CD.

If an error appears on the display, see "CD Messages" later in this section.

1 PREV (Previous): Press this pushbutton to go to the start of the current track. If you hold this pushbutton or press it more than once, the player will continue moving backward through the CD.

2 NEXT: Press this pushbutton to go to the next track. If you hold this pushbutton or press it more than once, the player will continue moving forward through the CD.

5 RDM (Random): Press this pushbutton to hear the tracks in random, rather than sequential, order. RDM will appear on the display. Press RDM again to turn off random play. When in random play, press the PREV pushbutton to repeat the current track one time.

6 RPT (Repeat): Press this pushbutton to hear a track over again. RPT will appear on the display. The current track will continue to repeat. Press RPT again to turn off repeat play.

▼ **REW (Rewind):** Press and hold the down arrow to rewind quickly within a track. Release it to play the passage. The display will show the elapsed time of the track.

▲ **FF (Fast Forward):** Press and hold the up arrow to advance quickly within a track. Release it to play the passage. The display will show the elapsed time of the track.

▲ **SEEK ▼** : Press the up arrow to go to the start of the current or of the previous track. Press the down arrow to go to the start of the next track. If you hold either arrow or press it more than once, the player will continue moving backward or forward through the CD.

RCL (Recall): Press this button to see the track number. Press this button again to see how long the current track has been playing.

AM FM: Press this button to listen to the radio when a CD is playing. The inactive CD will remain safely inside the radio for future listening.

CD TP (Tape): Press this button to play a CD when listening to the radio. Press this button to switch between the tape, CD, and DVD (if equipped) if loaded. The inactive tape, CD, or DVD will remain safely inside the radio for future listening.

EJ (Eject): Press this button, located to the left of the CD slot, to eject a CD. Eject may be activated with either the ignition or radio off.

If you eject a CD, but decide that you want to listen to it, press the CD/TP button. This will pull the CD back in and it will begin to play.

Playing the Six-Disc CD Player

If you turn off the ignition or radio with a CD in the player, it will stay in the player. When you turn on the ignition or radio, the CD will start playing where it stopped, if it was the last selected audio source.

As each new track starts to play, the track number will appear on the display.

The CD player can play the smaller 8 cm single CDs with an adapter ring. Full-size CDs and the smaller CDs are loaded in the same manner.

If playing a CD-R the sound quality may be reduced due to CD-R quality, the method of recording, the quality of the music that has been recorded, and the way the CD-R has been handled. You may experience an increase in skipping, difficulty in finding tracks and/or difficulty in loading and ejecting. If these problems occur try a known good CD.

Do not add paper labels to CDs, they could get caught in the CD player.

Do not play 3 inch CDs without a standard adapter CD.

If an error appears on the display, see “CD Messages” later in this section.

LD/EJ (Load/Eject): Press the LD side of this button to load CDs into the CD player. This CD player will hold up to six CDs.

To load or eject one CD, do the following:

1. Turn the ignition on.
2. Press and release the LD/EJ button. NUM will appear on the display. Flashing numbers at the bottom of the display indicate empty CD slots.

3. Press the pushbutton (1-6) for the CD slot to load or to eject. WAIT will appear on the display.
If a CD is already loaded the CD will eject.
If the CD slot is empty, LOAD will appear on the display, and a CD can be loaded.
4. Load a CD. Insert the CD partway into the slot, label side up. The player will pull the CD in.

If you select an equalization setting for your CD, it will be activated each time you play a CD.

If the radio is on or off, the CD will begin to play automatically.

To load or eject all CDs, do the following:

1. Turn the ignition on.
2. Press and hold the LD/EJ button.
If any CDs are loaded, EJT will appear on the display and the CDs will begin to eject.
When all slots are empty, LOAD will appear on the display.
3. Load, up to six CDs, in order, starting with slot 1.
Loading will continue until all six CDs are loaded or load is stopped by pressing any other radio button.

You can cancel the loading or the ejecting of a CD by pressing the LD/EJ button once, if in NUM selection, or twice, if the CD is already loading or ejecting.

1 PREV (Previous): Press this pushbutton to go to the start of the current track. If you hold this pushbutton or press it more than once, the player will continue moving backward through the CD.

2 NEXT: Press this pushbutton to go to the next track. If you hold this pushbutton or press it more than once, the player will continue moving forward through the CD.

5 RDM (Random): Press this pushbutton once to hear the tracks on the current CD in random, rather than sequential, order. RDM will appear on the display.

Press this pushbutton twice to hear the tracks on all of the CDs loaded in random, rather than sequential, order. ALL RDM will appear on the display.

Press this pushbutton a third time to turn off random play.

6 RPT (Repeat): Press this pushbutton to hear a track over again. RPT will appear on the display. The current track will continue to repeat. Press RPT again to turn off repeat play.

▼ **REW (Rewind)**: Press and hold the down arrow to rewind quickly within a track. Release it to play the passage. The display will show the elapsed time of the track.

▲ **FF (Fast Forward)**: Press and hold the up arrow to advance quickly within a track. Release it to play the passage. The display will show the elapsed time of the track.

▲ **CD SEEK ▼**: Press the up arrow to go to the previous CD. Press the down arrow to go to the next CD.

RCL (Recall): Press this button to see the track number, press this button again to see how long the current track has been playing.

AM FM: Press this button to listen to the radio when a CD is playing. The inactive CD will remain safely inside the radio for future listening.

AUX (Auxiliary): Press this button to play a CD when listening to the radio. Press this button to switch between the tape, CD, and DVD (if equipped) if loaded. The inactive tape, CD, or DVD will remain safely inside the radio for future listening.

CD Messages

If ERR appears on the display and the CD comes out, it could be for one of the following reasons:

- It is very hot. When the temperature returns to normal, the CD should play.
- You are driving on a very rough road. When the road becomes smooth, the CD should play.
- The CD is dirty, scratched, wet, or upside down.
- It is very humid. If so, wait about an hour and try again.
- There may have been a problem while burning the CD.
- The label may be caught in the CD player.

If the CD is not playing correctly, for any other reason, try a known good CD.

If any error occurs repeatedly or if an error cannot be corrected, contact your retailer. If your radio displays an error message, write it down and provide it to your retailer when reporting the problem.

Rear Seat Entertainment System

Your vehicle may have a DVD Rear Seat Entertainment (RSE) system. The RSE system works with the vehicles audio system and includes a DVD radio, a video display screen, two sets of wireless headphones, and a remote control.

Before You Drive

The RSE is designed for rear seat passengers only. The driver cannot safely view the video screen while driving and should not try to do so.

In severe or extreme weather conditions the RSE system may or may not work until the temperature is within the operating range. The operating range for the RSE system is above -4°F (-20°C) or below 140°F (60°C). If the temperature of your vehicle is outside of this range, heat or cool the vehicle until the temperature is within the operating range of the RSE system.

Headphones

The RSE system includes two sets of wireless headphones. The headphones are used to listen to the DVD radio or an auxiliary device connected to the RCA jacks. The wireless headphones have an ON/OFF switch and a volume control.

To use the headphones, turn the switch to ON. An indicator light located on the headphones will illuminate. If the light does not illuminate, the batteries may need to be replaced. See "Battery Replacement" later in this section for more information. Switch the headphones to OFF when not in use.

The transmitters are located in the display above the video screen. The headphones will shut off automatically to save the battery power if the DVD system is shut off or if the headphones are out of range of the transmitters for more than three minutes. If you move too far forward or step out of the vehicle, the headphones will lose the audio signal.

To adjust the volume on the headphones, use the volume control located on the right side.

Notice: Do not store the headphones in heat or direct sunlight. This could damage the headphones and repairs would not be covered by your warranty. Keep the headphones stored in a cool, dry place.

Battery Replacement

To change the batteries, do the following:

1. Slide open the battery door located on the left side of the headphones.
2. Replace the two AAA batteries in the compartment. Make sure that they are installed correctly, using the diagram on the inside of the battery compartment.
3. Slide the battery door shut.

If the headphones are to be stored for a long period of time, remove the batteries and keep them in a cool, dry place.

Stereo RCA Jacks

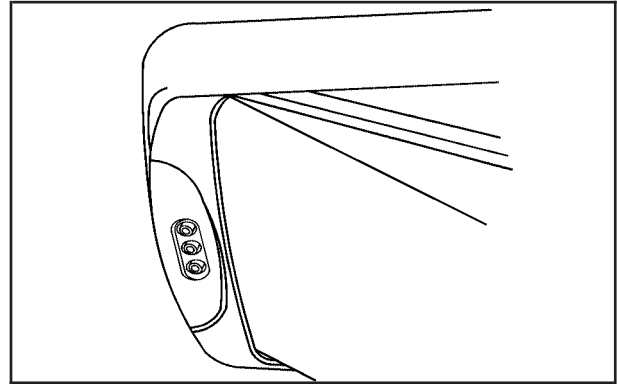

The RCA jacks are located behind the video screen on the overhead console. The RCA jacks allow audio or video signals to be connected from an auxiliary device such as a camcorder or a video game unit to the RSE. Adapter connectors or cables may be required to connect the auxiliary device to the RCA jacks. Refer to the manufacturer's instructions for proper usage.

The RCA jacks are color coded to match typical home entertainment system equipment. The yellow jack (right) is for the video input. The white jack (middle) is for the left audio input. The red jack (left) is for the right audio input.

To use the auxiliary function, connect a camcorder or a video game unit to the RCA jacks and turn on the auxiliary device. If you want to view a DVD, insert the DVD into the DVD radio. The system will automatically switch to DVD and start to play. To switch between the auxiliary device and the DVD, press the AUX button on the DVD player or on the remote control. See "DVD Radio" and "Remote Control" later in this section for more information.

Audio Output

Only one audio source can be heard through the speakers at one time.

The only way to listen to the audio through the vehicle speakers is if the front seat passengers select DVD Family Mode using the AUX button on the radio. Audio will still play through the wireless headphones.

There are three modes to the RSE system:

RSE: This is the default. When a DVD is inserted, the rear speakers will be muted. The rear seat passengers will be able to hear audio through the wireless headphones. The front seat passengers will be able to listen to the radio by pressing the AM FM button, or listen to XM™ Satellite Radio Service (if equipped) or CD, by pressing the AUX button, through the front speakers.

DVD Family: When in RSE mode, press the AUX button to switch to DVD Family. All passengers will be able to hear audio through the vehicles speakers. Audio will still be available through the wireless headphones.

DVD Aux: This is the default. When the RCA jacks are connected, the rear speakers will be muted. The rear seat passengers will be able to hear audio from the auxiliary device through the wireless headphones. The front seat passengers will be able to listen to the radio by pressing the AM FM button, or listen to XM™ Satellite Radio Service (if equipped) or CD, by pressing the AUX button, through the front speakers.

Video Screen

The video screen is located in the overhead console.

To use the video screen, do the following:

1. Push forward on the release button on the DVD display console.
2. Pull the screen down, away from you, and adjust its position as desired.

When the video screen is not in use, push it up into its locked position.

If a DVD is playing and the screen is raised to its locked position, the screen will shut off, but the DVD will continue to play through the previously selected audio source.

The video screen contains the transmitters for the wireless headphones and the remote control. If the screen is in the closed position, the signals will not be available for the operation of the headphones or the remote control.

Notice: Directly touching the video screen may damage it. Do not touch the screen. See “Cleaning the Video Screen” later in this section for more information.

DVD Radio

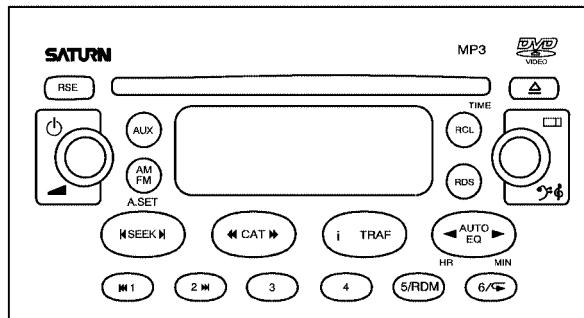

The DVD radio is located in the center of the instrument panel.

The DVD radio can be controlled by the buttons on the DVD radio and by the buttons on the remote control. See “Remote Control” later in this section for more information.

The DVD radio works while the ignition is in RUN or ACC.

The DVD radio is only compatible with DVDs authorized for use in the United States and Canada (Region Code 1). The DVD region code is printed on the jacket of most DVDs. Regular audio CDs, CD-R, CD-RW, and MP3s can also be played by the DVD radio.

If an error message appears on the video screen or the radio, see “DVD Display Error Messages” and “DVD Radio Error Messages” later in this section.

DVD Radio Buttons

RSE: Press this button to pause the DVD. Press this button again to play the DVD.

Press and hold this button for more than two seconds to turn off the DVD system.

AUX (Auxiliary): Press this button to switch between RSE and DVD family when a DVD is playing.

Press this button to switch between playing a CD or listening to XM™ Satellite Radio Service (if equipped) when a CD is playing.

 **(Eject/Load):** Press this button to eject a DVD or CD. If a DVD or CD is ejected, but not removed, pressing this button will load the DVD or CD.

Playing a Disc

To play a disc, gently insert the disc, with the label side up, into the loading slot. The DVD player will continue loading the disc and the player will automatically start.

If a disc is already in the radio, press the play/pause button on the remote control to start playing the disc.

Vehicle speaker volume, bass, treble, etc. may be adjusted using the radio controls.

Some DVDs will not allow fast forwarding or skipping of the copyright information or the previews. Some DVDs will begin playing after the previews have finished, although there may be a delay of up to 30 seconds. If the DVD does not begin playing the movie automatically, press the RSE button on the radio. If the DVD still does not play, refer to the on-screen instructions.

Stopping and Resuming Playback

To stop playing a disc, press the stop button on the remote control.

To resume playback, press the play/pause button on the remote control. The movie should resume play from where it last stopped if the disc has not been ejected and the stop button has not been pressed twice on the remote control. If the disc has been ejected or the stop button has been pressed twice on the remote control, the disc will resume playing at the beginning of the disc.

Ejecting a Disc

Press the eject button on the radio to eject the disc. If a disc is ejected from the radio, but not removed, the radio will reload the disc after a short period of time. The disc will be stored in the radio. The radio will not resume play of the disc automatically.

Remote Control

To use the remote control, aim it at the transmitter window below the video screen and press the desired button. Direct sunlight or very bright light may affect the ability of the RSE transmitter to receive signals from the remote control. If the remote control does not seem to be working, the batteries may need to be replaced. See "Battery Replacement" later in this section. Objects blocking the line of sight may also affect the function of the remote control.

Notice: Storing the remote control in a hot area or in direct sunlight may damage it, and the repairs would not be covered by your warranty. Keep the remote control stored in a cool, dry place.

Remote Control Buttons

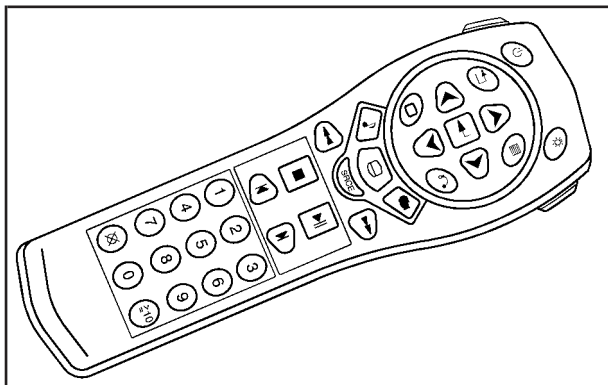

⏻ (Power): Press this button to turn the DVD player on and off.

⏪ (Title): Press this button to return the DVD to the main menu of the DVD.

⬆, ⬇, ⬅, ➡ (Menu Navigation Arrows): Use the arrow buttons to navigate through a menu.

⏻ (Set-up Menu): Press this button to adjust the color, tint, brightness, contrast, and display mode (normal, full, or zoom). The dynamic range compression feature can be used to reduce loud audio and increase low audio produced by some DVDs.

🎵 (Audio): Press this button to display a menu that will only appear when a DVD is playing. The format and content of this function will vary for each disc.

⏮ (Fast Reverse): Press this button to fast reverse the DVD or CD. To stop fast reversing, press this button again. This button may not work when the DVD is playing the copyright information or the previews.

SRCE (Source): Press this button to switch between the DVD player and an auxiliary source.

■ (Stop): Press this button to stop playing, rewinding, or fast forwarding a DVD or CD. Press this button twice to return to the beginning of the DVD.

⏮ (Previous Track/Chapter): Press this button to return to the start of the current track or chapter. Press this button again to go to the previous track or chapter. This button may not work when the DVD is playing the copyright information or the previews.

1 through 0 (Numeric Keypad): The numeric keypad provides the capability of direct chapter, title, and track number selection.

≥ 10 (Double Digit Entries): Press the button, to select chapter, title, and track numbers greater than 9. Press this button before inputting the number.

⊗ (Clear): Press this button, within 3 seconds after inputting a numeric selection to clear all numeric inputs.

☀ (Illumination): Press this button to turn the remote control backlight on. The backlight will time out after about 7 to 10 seconds if no other button is pressed while the backlight is on.

☰ (Main DVD Menu): Press this button to access the DVD menu. The DVD menu is different on every DVD. Use the up, down, left, and right arrow buttons to move the cursor around the DVD menu. After making a selection press the enter button. This button only operates when using a DVD.

↵ (Enter): Press this button to select the choices that are highlighted in any menu.

↶ (Return): Press this button to exit the current active menu and return to the previous menu. This button will operate only when a DVD is playing and a menu is active.

📷 (Camera Angle): Press this button to change camera angles on DVDs that have this feature when a DVD is playing. The format and content of this function will vary for each disc.

📄 (Subtitle): Press this button to turn on subtitles and to move through subtitle options when a DVD is playing. The format and content of this function will vary for each disc.

▶▶ (Fast Forward): Press this button to fast forward the DVD or CD. To stop fast forwarding, press this button again. This button may not work when the DVD is playing the copyright information or the previews.

▶ || **(Play/Pause):** Press this button to start play of a DVD or CD. Press this button while a DVD or CD is playing to pause it. Press this button again to continue playing the DVD or CD.

When the DVD is playing, press the pause button then press the fast forward button. The DVD will continue playing in a slow play mode. To cancel slow play mode, press the play/pause button.

▶ | **(Next Track/Chapter):** Press this button to advance to the beginning of the next track or chapter. This button may not work when the DVD is playing the copyright information or the previews.

Battery Replacement

To change the remote control batteries, do the following:

1. Remove the battery compartment door located on the bottom of the remote control.
2. Replace the two AA batteries in the compartment. Make sure that they are installed correctly, using the diagram on the inside of the battery compartment.
3. Close the battery door securely.

If the remote control is to be stored for a long period of time, remove the batteries and keep them in a cool, dry place.

DVD Display Error Messages

The video screen may display one of the following:

Disc Format Error: This message will be displayed, if a disc is inserted upside down, if the disc is not readable, or if the disc format is not compatible. The disc will be automatically ejected from the radio.

Disc Play Error: This message will be displayed, if the mechanism cannot play the disc. Severely scratched or damaged discs may cause this error. The disc will be automatically ejected from the radio.

Region Code Error: This message will be displayed, if the disc is not a Region Code 1. The disc will be automatically ejected from the radio.

Load/Eject Error: This message will be displayed, if the disc is not properly loaded or ejected.

No Disc: This message will be displayed, if no disc is present when the play, eject, or DVD/AUX button is pressed on the remote control or the eject, RSE, or AUX button is pressed on the radio.

DVD Radio Error Messages

The radio may display one of the following:

No Disc: This message will be displayed, if no disc is present when the play, eject, or DVD/AUX button is pressed on the remote control or the eject, RSE, or AUX button is pressed on the radio.

RSE Error: This message will be displayed for one of the following reasons:

- If a disc is inserted upside down, if the disc is not readable, or if the disc format is not compatible. The disc will be automatically ejected from the radio.
- If the mechanism cannot play the disc. Severely scratched discs may cause this error. The disc will be automatically ejected from the radio.
- If the disc is not a Region Code 1. The disc will be automatically ejected from the radio.
- If the disc is not properly loaded or ejected.

DVD Distortion

There may be an experience with video distortion when operating cellular phones, scanners, CB radios, Global Position Systems (GPS)*, two-way radios, mobile fax, or walkie talkies.

It may be necessary to turn off the DVD player when operating one of these devices in or near the vehicle.

*Excludes the OnStar® System.

Cleaning the DVD Player

When cleaning the outside DVD faceplate and buttons, use only a clean cloth dampened with clean water.

Cleaning the Video Screen

When cleaning the video screen, use only a clean cloth dampened with clean water. Use care when directly touching or cleaning the screen, as damage may result.

Theft-Deterrent Feature

The Radio with Cassette and CD and the Radio with Cassette and Six-Disc CD have a theft deterrent feature.

The theft deterrent feature is designed to discourage theft of your vehicle's radio. It works by using a secret code to disable all radio functions whenever battery power is interrupted.

The theft deterrent feature for the radio may be used or ignored. If ignored, the radio plays normally and the radio is not protected by the feature. If the theft deterrent feature is activated, the radio will not operate if stolen.

When the theft deterrent feature is activated, LOCK will appear on the radio display to indicate a locked condition anytime battery power has been interrupted. If the battery loses power for any reason, you must unlock the radio with the secret code before it will operate.

Activating the Theft-Deterrent Feature

The instructions which follow explain how to enter your secret code to activate the theft deterrent feature. Read through all 10 steps before starting the procedure.

If you allow more than 15 seconds to elapse between any steps, the radio automatically reverts to time and you must start the procedure over at Step 4.

1. Write down any four-digit number from 0000 to 9999 and keep it in a safe place separate from the vehicle.
2. Turn the ignition to RUN.
3. Turn the radio off.
4. Press the 5 and 6 pushbuttons at the same time for five seconds. -- -- -- -- will appear on the display. Next you will use the secret code number which you have written down.

5. Press the SEEK/SCAN up arrow to make the first digit agree with your code.
6. Press the SEEK/SCAN down arrow to make the second digit agree with your code.
7. Press the TUNE up arrow to make the third digit agree with your code.
8. Press the TUNE down arrow to make the fourth digit agree with your code.
9. Press AM-FM after you have confirmed that the code matches the secret code you have written down. REP will appear on the display to indicate that Steps 5 through 8 need to be repeated to confirm your secret code.
10. Press AM-FM again. SEC will appear on the display to indicate that the radio is secure.

If SEC is not displayed, but displays Err1, Err2, or LOCK, the theft deterrent feature is already set to another code. See "Disabling the Theft-Deterrent Feature" later in this section.

Unlocking the Theft-Deterrent Feature After a Power Loss

Enter your secret code as follows; pause no more than 15 seconds between steps:

1. Turn the ignition on. -- -- -- -- will appear on the display.
2. Perform Steps 5 through 8 from the "Activating the Theft-Deterrent Feature" earlier to enter your secret code.
3. Press AM-FM after you have confirmed that the code matches the secret code you have written down. SEC will appear on the display, indicating the radio is now operable and secure.

If you enter the wrong code, the display will momentarily show an error message and all radio functions will continue to be disabled. If -- -- -- -- appears on the display, you can try to enter your secret code again.

If you enter the wrong code three times, LOCK will appear on the display. Contact your retailer. Your retailer is authorized to obtain the factory programmed code that is assigned to the radio to reset the system.

If you forget your code, if the theft deterrent feature is accidentally activated with an unknown code, or if the radio is in the locked mode, contact your retailer.

Disabling the Theft-Deterrent Feature

Enter your secret code as follows; pause no more than 15 seconds between steps:

Perform Steps 1 through 9 from the "Activating the Theft-Deterrent Feature" earlier to enter your secret code. OFF will appear on the display indicating the theft deterrent feature is off.

If OFF does not appear on the display, the wrong code was entered. If you enter the wrong code, the display will momentarily show an error message and all radio functions will continue to be disabled. If -- -- -- -- appears on the display, you can try to enter your secret code again.

If you enter the wrong code three times, LOCK will appear on the display. Contact your retailer. Your retailer is authorized to obtain the factory programmed code that is assigned to the radio to reset the system.

If you forget your code, if the theft deterrent feature is accidentally activated with an unknown code, or if the radio is in the locked mode, contact your retailer.

Radio Reception

AM

The range for most AM stations is greater than for FM, especially at night. The longer range, however, can cause stations to interfere with each other. AM can pick up noise from things like storms and power lines. Try reducing the treble to reduce this noise.

FM

FM stereo will give you the best sound, but FM signals will reach only about 10 to 40 miles (16 to 65 km). Tall buildings or hills can interfere with FM signals, causing the sound to come and go.

Care of Your Cassette Tape Player

A tape player that is not cleaned regularly can cause reduced sound quality, ruined cassettes, or a damaged mechanism. Cassette tapes should be stored in their cases away from contaminants, direct sunlight, and extreme heat. If they are not, they may not operate properly or they may cause failure of the tape player.

The tape player should be cleaned regularly after every 30 hours of use. The radio may display CLEAN to indicate that the tape player has been used for 30 hours without resetting the tape clean timer. If this message appears on the display, the cassette tape player needs to be cleaned. It will still play tapes, but it should be cleaned as soon as possible to prevent damage to the tapes and player. If there is a reduction in sound quality, try a known good cassette to see if the tape or the tape player is at fault. If this other cassette has no improvement in sound quality, clean the tape player.

For best results, use a scrubbing action, non-abrasive cleaning cassette with pads which scrub the tape head as the hubs of the cleaner cassette turn. The recommended cleaning cassette is available through your retailer.

The cut tape detection feature of the cassette tape player may identify the cleaning cassette as a damaged tape, in error. If the cleaning cassette ejects, insert the cassette at least three times to ensure thorough cleaning.

A non-scrubbing action, wet-type cleaner which uses a cassette with a fabric belt to clean the tape head can be used. This type of cleaning cassette will not eject on its own. A non-scrubbing action cleaner may not clean as thoroughly as the scrubbing type cleaner. The use of a non-scrubbing action, dry-type cleaning cassette is not recommended.

After the player is cleaned, insert a cassette tape, press and hold the eject button for five seconds to reset the CLEAN indicator. CLEAN will no longer appear on the display to show the indicator was reset.

Cassettes are subject to wear and the sound quality may degrade over time. Always make sure the cassette tape is in good condition before the tape player is serviced.

Care of Your CDs and DVDs

Handle discs carefully. Store them in their original cases or other protective cases and away from direct sunlight and dust. If the surface of a disc is soiled, dampen a clean, soft cloth in a mild, neutral detergent solution and clean it, wiping from the center to the edge.

Be sure never to touch the side without writing when handling discs. Pick up discs by grasping the outer edges or the edge of the hole and the outer edge.

Care of Your CD and DVD Player

The use of CD lens cleaners for CDs is not advised, due to the risk of contaminating the lens of the CD optics with lubricants internal to the CD mechanism.

Fixed Mast Antenna

The fixed mast antenna can withstand most car washes without being damaged. If the mast should ever become slightly bent, straighten it out by hand. If the mast is badly bent, replace it.

Check occasionally to make sure the mast is still tightened to the rear quarter panel.

Section 4 Driving Your Vehicle

Your Driving, the Road, and Your Vehicle	4-2	City Driving	4-20
Defensive Driving	4-2	Freeway Driving	4-21
Drunken Driving	4-2	Before Leaving on a Long Trip	4-23
Control of a Vehicle	4-5	Highway Hypnosis	4-23
Braking	4-6	Hill and Mountain Roads	4-24
Traction Control System (TCS)	4-9	Winter Driving	4-26
Steering	4-10	If You Are Stuck: In Sand, Mud, Ice or Snow	4-30
Off-Road Recovery	4-12	Towing	4-32
Passing	4-13	Towing Your Vehicle	4-32
Loss of Control	4-14	Recreational Vehicle Towing	4-32
Driving at Night	4-15	Loading Your Vehicle	4-34
Driving in Rain and on Wet Roads	4-17	Towing a Trailer	4-40

Your Driving, the Road, and Your Vehicle

Defensive Driving

The best advice anyone can give about driving is: Drive defensively.

Please start with a very important safety device in your vehicle: Buckle up. See *Safety Belts: They Are for Everyone* on page 1-11.

Defensive driving really means “be ready for anything.” On city streets, rural roads or freeways, it means “always expect the unexpected.”

Assume that pedestrians or other drivers are going to be careless and make mistakes. Anticipate what they might do. Be ready for their mistakes.

Rear-end collisions are about the most preventable of accidents. Yet they are common. Allow enough following distance. It is the best defensive driving maneuver, in both city and rural driving. You never know when the vehicle in front of you is going to brake or turn suddenly.

Defensive driving requires that a driver concentrate on the driving task. Anything that distracts from the driving task — such as concentrating on a cellular telephone call,

reading, or reaching for something on the floor — makes proper defensive driving more difficult and can even cause a collision, with resulting injury. Ask a passenger to help do things like this, or pull off the road in a safe place to do them yourself. These simple defensive driving techniques could save your life.

Drunken Driving

Death and injury associated with drinking and driving is a national tragedy. It is the number one contributor to the highway death toll, claiming thousands of victims every year.

Alcohol affects four things that anyone needs to drive a vehicle:

- Judgment
- Muscular Coordination
- Vision
- Attentiveness.

Police records show that almost half of all motor vehicle-related deaths involve alcohol. In most cases, these deaths are the result of someone who was drinking and driving. In recent years, more than 16,000 annual motor vehicle-related deaths have been associated with the use of alcohol, with more than 300,000 people injured.

Many adults — by some estimates, nearly half the adult population — choose never to drink alcohol, so they never drive after drinking. For persons under 21, it is against the law in every U.S. state to drink alcohol. There are good medical, psychological and developmental reasons for these laws.

The obvious way to eliminate the leading highway safety problem is for people never to drink alcohol and then drive. But what if people do? How much is “too much” if someone plans to drive? It is a lot less than many might think. Although it depends on each person and situation, here is some general information on the problem.

The Blood Alcohol Concentration (BAC) of someone who is drinking depends upon four things:

- The amount of alcohol consumed
- The drinker's body weight
- The amount of food that is consumed before and during drinking
- The length of time it has taken the drinker to consume the alcohol.

According to the American Medical Association, a 180 lb (82 kg) person who drinks three 12 ounce (355 ml) bottles of beer in an hour will end up with a BAC of about 0.06 percent. The person would reach the

same BAC by drinking three 4 ounce (120 ml) glasses of wine or three mixed drinks if each had 1-1/2 ounces (45 ml) of liquors like whiskey, gin or vodka.



It is the amount of alcohol that counts. For example, if the same person drank three double martinis (3 ounces or 90 ml of liquor each) within an hour, the person's BAC would be close to 0.12 percent. A person who consumes food just before or during drinking will have a somewhat lower BAC level.

There is a gender difference, too. Women generally have a lower relative percentage of body water than men. Since alcohol is carried in body water, this means that a woman generally will reach a higher BAC level than a man of her same body weight will when each has the same number of drinks.

The law in an increasing number of U.S. states, and throughout Canada, sets the legal limit at 0.08 percent. In some other countries, the limit is even lower. For example, it is 0.05 percent in both France and Germany. The BAC limit for all commercial drivers in the United States is 0.04 percent.

The BAC will be over 0.10 percent after three to six drinks (in one hour). Of course, as we have seen, it depends on how much alcohol is in the drinks, and how quickly the person drinks them.

But the ability to drive is affected well below a BAC of 0.10 percent. Research shows that the driving skills of many people are impaired at a BAC approaching 0.05 percent, and that the effects are worse at night. All drivers are impaired at BAC levels above 0.05 percent. Statistics show that the chance of being in a collision increases sharply for drivers who have a BAC of 0.05 percent or above.

A driver with a BAC level of 0.06 percent has doubled his or her chance of having a collision. At a BAC level of 0.10 percent, the chance of this driver having a collision is 12 times greater; at a level of 0.15 percent, the chance is 25 times greater!

The body takes about an hour to rid itself of the alcohol in one drink. No amount of coffee or number of cold showers will speed that up. "I will be careful" is not the right answer. What if there is an emergency, a need to take sudden action, as when a child darts into the street? A person with even a moderate BAC might not be able to react quickly enough to avoid the collision.

There is something else about drinking and driving that many people do not know. Medical research shows that alcohol in a person's system can make crash injuries worse, especially injuries to the brain, spinal cord or heart. This means that when anyone who has been drinking — driver or passenger — is in a crash, that person's chance of being killed or permanently disabled is higher than if the person had not been drinking.

⚠ CAUTION:

Drinking and then driving is very dangerous. Your reflexes, perceptions, attentiveness and judgment can be affected by even a small amount of alcohol. You can have a serious — or even fatal — collision if you drive after drinking. Please do not drink and drive or ride with a driver who has been drinking. Ride home in a cab; or if you are with a group, designate a driver who will not drink.

Control of a Vehicle

You have three systems that make your vehicle go where you want it to go. They are the brakes, the steering and the accelerator. All three systems have to do their work at the places where the tires meet the road.



Sometimes, as when you are driving on snow or ice, it is easy to ask more of those control systems than the tires and road can provide. That means you can lose control of your vehicle. Also see *Traction Control System (TCS)* on page 4-9.

Braking

Braking action involves *perception time* and *reaction time*.

First, you have to decide to push on the brake pedal. That is *perception time*. Then you have to bring up your foot and do it. That is *reaction time*.

Average *reaction time* is about 3/4 of a second. But that is only an average. It might be less with one driver and as long as two or three seconds or more with another. Age, physical condition, alertness, coordination and eyesight all play a part. So do alcohol, drugs and frustration. But even in 3/4 of a second, a vehicle moving at 60 mph (100 km/h) travels 66 feet (20 m). That could be a lot of distance in an emergency, so keeping enough space between your vehicle and others is important.

And, of course, actual stopping distances vary greatly with the surface of the road (whether it is pavement or gravel); the condition of the road (wet, dry, icy); tire tread; the condition of your brakes; the weight of the vehicle and the amount of brake force applied.

Avoid needless heavy braking. Some people drive in spurts — heavy acceleration followed by heavy braking — rather than keeping pace with traffic. This is a mistake. Your brakes may not have time to cool between hard stops. Your brakes will wear out much faster if you do a lot of heavy braking. If you keep pace with the traffic and allow realistic following distances, you will eliminate a lot of unnecessary braking. That means better braking and longer brake life.

If your engine ever stops while you are driving, brake normally but do not pump your brakes. If you do, the pedal may get harder to push down. If your engine stops, you will still have some power brake assist. But you will use it when you brake. Once the power assist is used up, it may take longer to stop and the brake pedal will be harder to push.

Anti-lock Brake System (ABS)

Your vehicle has anti-lock brakes. ABS is an advanced electronic braking system that will help prevent a braking skid.

When you start your engine and begin to drive away, your anti-lock brake system will check itself. You may hear a momentary motor or clicking noise while this test is going on, and you may even notice that your brake pedal moves a little. This is normal.

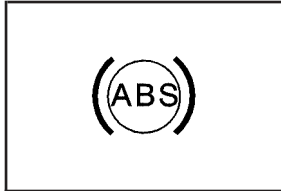

If there is a problem with the anti-lock brake system, this warning light will stay on. See *Anti-Lock Brake System Warning Light* on page 3-31.



Let us say the road is wet and you are driving safely. Suddenly, an animal jumps out in front of you. You slam on the brakes and continue braking. Here is what happens with ABS:

A computer senses that wheels are slowing down. If one of the wheels is about to stop rolling, the computer will separately work the brakes at each wheel.

The anti-lock system can change the brake pressure faster than any driver could. The computer is programmed to make the most of available tire and road conditions. This can help you steer around the obstacle while braking hard.



As you brake, your computer keeps receiving updates on wheel speed and controls braking pressure accordingly.

Remember: Anti-lock does not change the time you need to get your foot up to the brake pedal or always decrease stopping distance. If you get too close to the vehicle in front of you, you will not have time to apply your brakes if that vehicle suddenly slows or stops. Always leave enough room up ahead to stop, even though you have anti-lock brakes.

Using Anti-Lock

Do not pump the brakes. Just hold the brake pedal down firmly and let anti-lock work for you. You may hear the anti-lock pump or motor operate, and feel the brake pedal pulsate, but this is normal.

Braking in Emergencies

With anti-lock, you can steer and brake at the same time. In many emergencies, steering can help you more than even the very best braking.

Traction Control System (TCS)

Your vehicle has a traction control system that limits wheel spin. This is especially useful in slippery road conditions. The system operates only if it senses that one or both of the front wheels are spinning or beginning to lose traction. When this happens, the system works the front brakes and reduces engine power to limit wheel spin.

You may feel or hear the system working, but this is normal.

If your vehicle is in cruise control when the traction control system begins to limit wheel spin, the cruise control will automatically disengage. When road conditions allow you to safely use it again, you may reengage the cruise control. See "Cruise Control" under *Turn Signal/Multifunction Lever on page 3-6*.



This light should come on briefly when you start the engine. If it stays on or comes on while you are driving, there's a problem with your traction control system.

See *Traction Control System (TCS) Warning Light on page 3-32*. When this warning light is on, the system will not limit wheel spin. Adjust your driving accordingly.

The traction control system automatically comes on whenever you start your vehicle. To limit wheel spin, especially in slippery road conditions, you should always leave the system on. But you can turn the traction control system off if you ever need to. You should turn the system off if your vehicle ever gets stuck in sand, mud or snow and rocking the vehicle is required. See *If You Are Stuck: In Sand, Mud, Ice or Snow on page 4-30*.

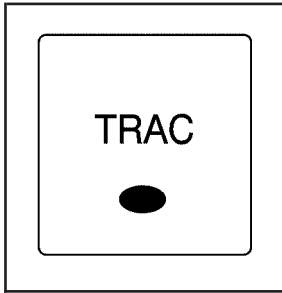

To turn the system off, press the trac switch.

The traction control system warning light will come on and stay on. If the system is limiting wheel spin when you press the button, the warning light will come on – but the system won't turn off right away. It will wait until there's no longer a current need to limit wheel spin.

You can turn the system back on at any time by pressing the button again. The traction control system warning light should go off.

Steering

Power Steering

If you lose power steering assist because the engine stops or the system is not functioning, you can steer but it will take much more effort.

Steering Tips

Driving on Curves

It is important to take curves at a reasonable speed.

A lot of the “driver lost control” accidents mentioned on the news happen on curves. Here is why:

Experienced driver or beginner, each of us is subject to the same laws of physics when driving on curves. The traction of the tires against the road surface makes it possible for the vehicle to change its path when you turn the front wheels. If there is no traction, inertia will keep the vehicle going in the same direction. If you have ever tried to steer a vehicle on wet ice, you will understand this.

The traction you can get in a curve depends on the condition of your tires and the road surface, the angle at which the curve is banked, and your speed. While you are in a curve, speed is the one factor you can control.

Suppose you are steering through a sharp curve. Then you suddenly apply the brakes. Both control systems — steering and braking — have to do their work where the tires meet the road. Unless you have four-wheel anti-lock brakes, adding the hard braking can demand too much of those places. You can lose control.

The same thing can happen if you are steering through a sharp curve and you suddenly accelerate. Those two control systems — steering and acceleration — can overwhelm those places where the tires meet the road and make you lose control. See *Traction Control System (TCS) on page 4-9*.

What should you do if this ever happens? Ease up on the brake or accelerator pedal, steer the vehicle the way you want it to go, and slow down.

Speed limit signs near curves warn that you should adjust your speed. Of course, the posted speeds are based on good weather and road conditions. Under less favorable conditions you will want to go slower.

If you need to reduce your speed as you approach a curve, do it before you enter the curve, while your front wheels are straight ahead.

Try to adjust your speed so you can “drive” through the curve. Maintain a reasonable, steady speed. Wait to accelerate until you are out of the curve, and then accelerate gently into the straightaway.

Steering in Emergencies

There are times when steering can be more effective than braking. For example, you come over a hill and find a truck stopped in your lane, or a car suddenly pulls out from nowhere, or a child darts out from between parked cars and stops right in front of you. You can avoid these problems by braking — if you can stop in time. But sometimes you can not; there is not room. That is the time for evasive action — steering around the problem.

Your vehicle can perform very well in emergencies like these. First apply your brakes — but, unless you have anti-lock, not enough to lock your wheels.

See *Braking on page 4-6*. It is better to remove as much speed as you can from a possible collision. Then steer around the problem, to the left or right depending on the space available.

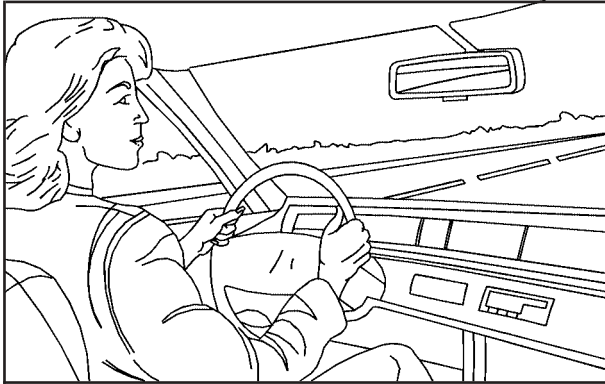

An emergency like this requires close attention and a quick decision. If you are holding the steering wheel at the recommended 9 and 3 o'clock positions, you can turn it a full 180 degrees very quickly without removing either hand. But you have to act fast, steer quickly, and just as quickly straighten the wheel once you have avoided the object.

The fact that such emergency situations are always possible is a good reason to practice defensive driving at all times and wear safety belts properly.

Off-Road Recovery

You may find that your right wheels have dropped off the edge of a road onto the shoulder while you're driving.

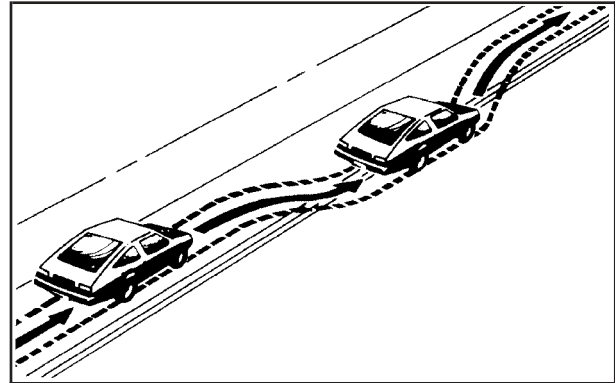

If the level of the shoulder is only slightly below the pavement, recovery should be fairly easy. Ease off the accelerator and then, if there is nothing in the way, steer so that your vehicle straddles the edge of the pavement. You can turn the steering wheel up to one-quarter turn until the right front tire contacts the pavement edge. Then turn your steering wheel to go straight down the roadway.

Passing

The driver of a vehicle about to pass another on a two-lane highway waits for just the right moment, accelerates, moves around the vehicle ahead, then goes back into the right lane again. A simple maneuver?

Not necessarily! Passing another vehicle on a two-lane highway is a potentially dangerous move, since the passing vehicle occupies the same lane as oncoming traffic for several seconds. A miscalculation, an error in judgment, or a brief surrender to frustration or anger can suddenly put the passing driver face to face with the worst of all traffic accidents — the head-on collision.

So here are some tips for passing:

- “Drive ahead.” Look down the road, to the sides and to crossroads for situations that might affect your passing patterns. If you have any doubt whatsoever about making a successful pass, wait for a better time.
- Watch for traffic signs, pavement markings and lines. If you can see a sign up ahead that might indicate a turn or an intersection, delay your pass. A broken center line usually indicates it is all right to pass (providing the road ahead is clear). Never cross a solid line on your side of the lane or a double solid line, even if the road seems empty of approaching traffic.

- Do not get too close to the vehicle you want to pass while you are awaiting an opportunity. For one thing, following too closely reduces your area of vision, especially if you are following a larger vehicle. Also, you will not have adequate space if the vehicle ahead suddenly slows or stops. Keep back a reasonable distance.
- When it looks like a chance to pass is coming up, start to accelerate but stay in the right lane and do not get too close. Time your move so you will be increasing speed as the time comes to move into the other lane. If the way is clear to pass, you will have a “running start” that more than makes up for the distance you would lose by dropping back. And if something happens to cause you to cancel your pass, you need only slow down and drop back again and wait for another opportunity.
- If other vehicles are lined up to pass a slow vehicle, wait your turn. But take care that someone is not trying to pass you as you pull out to pass the slow vehicle. Remember to glance over your shoulder and check the blind spot.

- Check your mirrors, glance over your shoulder, and start your left lane change signal before moving out of the right lane to pass. When you are far enough ahead of the passed vehicle to see its front in your inside mirror, activate your right lane change signal and move back into the right lane. (Remember that your right outside mirror is convex. The vehicle you just passed may seem to be farther away from you than it really is.)
- Try not to pass more than one vehicle at a time on two-lane roads. Reconsider before passing the next vehicle.
- Do not overtake a slowly moving vehicle too rapidly. Even though the brake lamps are not flashing, it may be slowing down or starting to turn.
- If you are being passed, make it easy for the following driver to get ahead of you. Perhaps you can ease a little to the right.

Loss of Control

Let us review what driving experts say about what happens when the three control systems (brakes, steering and acceleration) do not have enough friction where the tires meet the road to do what the driver has asked.

In any emergency, do not give up. Keep trying to steer and constantly seek an escape route or area of less danger.

Skidding

In a skid, a driver can lose control of the vehicle. Defensive drivers avoid most skids by taking reasonable care suited to existing conditions, and by not “overdriving” those conditions. But skids are always possible.

The three types of skids correspond to your vehicle’s three control systems. In the braking skid, your wheels are not rolling. In the steering or cornering skid, too much speed or steering in a curve causes tires to slip and lose cornering force. And in the acceleration skid, too much throttle causes the driving wheels to spin.

A cornering skid and an acceleration skid are best handled by easing your foot off the accelerator pedal.

If your vehicle starts to slide, ease your foot off the accelerator pedal and quickly steer the way you want the vehicle to go. If you start steering quickly enough, your vehicle may straighten out. Always be ready for a second skid if it occurs.

Of course, traction is reduced when water, snow, ice, gravel or other material is on the road. For safety, you will want to slow down and adjust your driving to these conditions. It is important to slow down on slippery surfaces because stopping distance will be longer and vehicle control more limited.

While driving on a surface with reduced traction, try your best to avoid sudden steering, acceleration or braking (including engine braking by shifting to a lower gear). Any sudden changes could cause the tires to slide. You may not realize the surface is slippery until your vehicle is skidding. Learn to recognize warning clues — such as enough water, ice or packed snow on the road to make a “mirrored surface” — and slow down when you have any doubt.

If you have the anti-lock braking system, remember: It helps avoid only the braking skid. If you do not have anti-lock, then in a braking skid (where the wheels are no longer rolling), release enough pressure on the brakes to get the wheels rolling again. This restores steering control. Push the brake pedal down steadily when you have to stop suddenly. As long as the wheels are rolling, you will have steering control.

Driving at Night

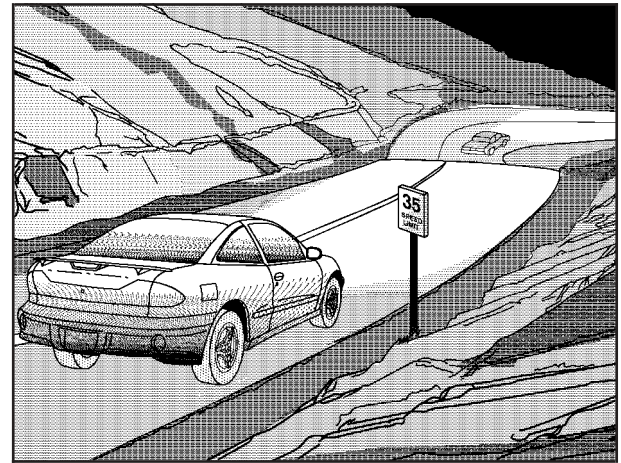

Night driving is more dangerous than day driving. One reason is that some drivers are likely to be impaired — by alcohol or drugs, with night vision problems, or by fatigue.

Here are some tips on night driving.

- Drive defensively.
- Do not drink and drive.
- Adjust your inside rearview mirror to reduce the glare from headlamps behind you.
- Since you can not see as well, you may need to slow down and keep more space between you and other vehicles.
- Slow down, especially on higher speed roads. Your headlamps can light up only so much road ahead.
- In remote areas, watch for animals.
- If you are tired, pull off the road in a safe place and rest.

No one can see as well at night as in the daytime. But as we get older these differences increase. A 50-year-old driver may require at least twice as much light to see the same thing at night as a 20-year-old.

What you do in the daytime can also affect your night vision. For example, if you spend the day in bright sunshine you are wise to wear sunglasses. Your eyes will have less trouble adjusting to night. But if you are driving, do not wear sunglasses at night. They may cut down on glare from headlamps, but they also make a lot of things invisible.

You can be temporarily blinded by approaching headlamps. It can take a second or two, or even several seconds, for your eyes to readjust to the dark. When you are faced with severe glare (as from a driver who does not lower the high beams, or a vehicle with misaimed headlamps), slow down a little. Avoid staring directly into the approaching headlamps.

Keep your windshield and all the glass on your vehicle clean — inside and out. Glare at night is made much worse by dirt on the glass. Even the inside of the glass can build up a film caused by dust. Dirty glass makes lights dazzle and flash more than clean glass would, making the pupils of your eyes contract repeatedly.

Remember that your headlamps light up far less of a roadway when you are in a turn or curve. Keep your eyes moving; that way, it is easier to pick out dimly lighted objects. Just as your headlamps should be checked regularly for proper aim, so should your eyes be examined regularly. Some drivers suffer from night blindness — the inability to see in dim light — and are not even aware of it.

Driving in Rain and on Wet Roads

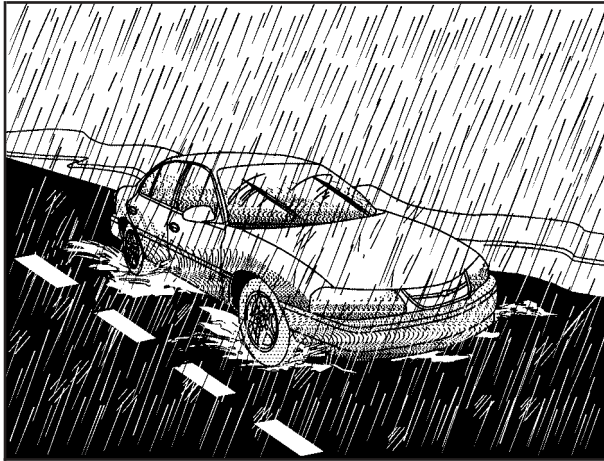

Rain and wet roads can mean driving trouble. On a wet road, you can not stop, accelerate or turn as well because your tire-to-road traction is not as good as on dry roads.

And, if your tires do not have much tread left, you will get even less traction. It is always wise to go slower and be cautious if rain starts to fall while you are driving. The surface may get wet suddenly when your reflexes are tuned for driving on dry pavement.

The heavier the rain, the harder it is to see. Even if your windshield wiper blades are in good shape, a heavy rain can make it harder to see road signs and traffic signals, pavement markings, the edge of the road and even people walking.

It is wise to keep your windshield wiping equipment in good shape and keep your windshield washer tank filled with washer fluid. Replace your windshield wiper inserts when they show signs of streaking or missing areas on the windshield, or when strips of rubber start to separate from the inserts.

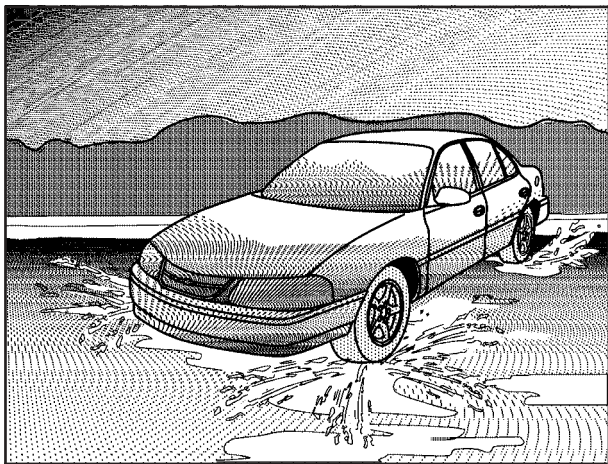

Driving too fast through large water puddles or even going through some car washes can cause problems, too. The water may affect your brakes. Try to avoid puddles. But if you can not, try to slow down before you hit them.

⚠ CAUTION:

Wet brakes can cause accidents. They will not work as well in a quick stop and may cause pulling to one side. You could lose control of the vehicle.

After driving through a large puddle of water or a car wash, apply your brake pedal lightly until your brakes work normally.

Hydroplaning

Hydroplaning is dangerous. So much water can build up under your tires that they can actually ride on the water. This can happen if the road is wet enough and you are going fast enough. When your vehicle is hydroplaning, it has little or no contact with the road.

Hydroplaning does not happen often. But it can if your tires do not have much tread or if the pressure in one or more is low. It can happen if a lot of water is standing on the road. If you can see reflections from trees, telephone poles or other vehicles, and raindrops “dimple” the water’s surface, there could be hydroplaning.

Hydroplaning usually happens at higher speeds. There just is not a hard and fast rule about hydroplaning. The best advice is to slow down when it is raining.

Driving Through Deep Standing Water

Notice: If you drive too quickly through deep puddles or standing water, water can come in through your engine’s air intake and badly damage your engine. Never drive through water that is slightly lower than the underbody of your vehicle. If you can not avoid deep puddles or standing water, drive through them very slowly.

Driving Through Flowing Water

CAUTION:

Flowing or rushing water creates strong forces. If you try to drive through flowing water, as you might at a low water crossing, your vehicle can be carried away. As little as six inches of flowing water can carry away a smaller vehicle. If this happens, you and other vehicle occupants could drown. Do not ignore police warning signs, and otherwise be very cautious about trying to drive through flowing water.

Some Other Rainy Weather Tips

- Turn on your low-beam headlamps — not just your parking lamps — to help make you more visible to others.
- Besides slowing down, allow some extra following distance. And be especially careful when you pass another vehicle. Allow yourself more clear room ahead, and be prepared to have your view restricted by road spray.
- Have good tires with proper tread depth. See *Tires* on page 5-54.

City Driving



One of the biggest problems with city streets is the amount of traffic on them. You will want to watch out for what the other drivers are doing and pay attention to traffic signals.

Here are ways to increase your safety in city driving:

- Know the best way to get to where you are going. Get a city map and plan your trip into an unknown part of the city just as you would for a cross-country trip.
- Try to use the freeways that rim and crisscross most large cities. You will save time and energy. See *Freeway Driving* on page 4-21.
- Treat a green light as a warning signal. A traffic light is there because the corner is busy enough to need it. When a light turns green, and just before you start to move, check both ways for vehicles that have not cleared the intersection or may be running the red light.

Freeway Driving



Mile for mile, freeways (also called thruways, parkways, expressways, turnpikes or superhighways) are the safest of all roads. But they have their own special rules.

The most important advice on freeway driving is: Keep up with traffic and keep to the right. Drive at the same speed most of the other drivers are driving. Too-fast or too-slow driving breaks a smooth traffic flow. Treat the left lane on a freeway as a passing lane.

At the entrance, there is usually a ramp that leads to the freeway. If you have a clear view of the freeway as you drive along the entrance ramp, you should begin to check traffic. Try to determine where you expect to blend with the flow. Try to merge into the gap at close to the prevailing speed. Switch on your turn signal, check your mirrors and glance over your shoulder as often as necessary. Try to blend smoothly with the traffic flow.

Once you are on the freeway, adjust your speed to the posted limit or to the prevailing rate if it is slower. Stay in the right lane unless you want to pass.

Before changing lanes, check your mirrors. Then use your turn signal.

Just before you leave the lane, glance quickly over your shoulder to make sure there is not another vehicle in your "blind" spot.

Once you are moving on the freeway, make certain you allow a reasonable following distance.

Expect to move slightly slower at night.

When you want to leave the freeway, move to the proper lane well in advance. If you miss your exit, do not, under any circumstances, stop and back up. Drive on to the next exit.

The exit ramp can be curved, sometimes quite sharply. The exit speed is usually posted. Reduce your speed according to your speedometer, not to your sense of motion. After driving for any distance at higher speeds, you may tend to think you are going slower than you actually are.

Before Leaving on a Long Trip

Make sure you are ready. Try to be well rested. If you must start when you are not fresh — such as after a day's work — do not plan to make too many miles that first part of the journey. Wear comfortable clothing and shoes you can easily drive in.

Is your vehicle ready for a long trip? If you keep it serviced and maintained, it is ready to go. If it needs service, have it done before starting out. Of course, you will find experienced and able service experts at Saturn retailers all across North America. They will be ready and willing to help if you need it.

Here are some things you can check before a trip:

- *Windshield Washer Fluid*: Is the reservoir full? Are all windows clean inside and outside?
- *Wiper Blades*: Are they in good shape?
- *Fuel, Engine Oil, Other Fluids*: Have you checked all levels?
- *Lamps*: Are they all working? Are the lenses clean?

- *Tires*: They are vitally important to a safe, trouble-free trip. Is the tread good enough for long-distance driving? Are the tires all inflated to the recommended pressure?
- *Weather Forecasts*: What is the weather outlook along your route? Should you delay your trip a short time to avoid a major storm system?
- *Maps*: Do you have up-to-date maps?

Highway Hypnosis

Is there actually such a condition as “highway hypnosis”? Or is it just plain falling asleep at the wheel? Call it highway hypnosis, lack of awareness, or whatever.

There is something about an easy stretch of road with the same scenery, along with the hum of the tires on the road, the drone of the engine, and the rush of the wind against the vehicle that can make you sleepy. Do not let it happen to you! If it does, your vehicle can leave the road in *less than a second*, and you could crash and be injured.

What can you do about highway hypnosis? First, be aware that it can happen.

Then here are some tips:

- Make sure your vehicle is well ventilated, with a comfortably cool interior.
- Keep your eyes moving. Scan the road ahead and to the sides. Check your rearview mirrors and your instruments frequently.
- If you get sleepy, pull off the road into a rest, service or parking area and take a nap, get some exercise, or both. For safety, treat drowsiness on the highway as an emergency.

Hill and Mountain Roads



Driving on steep hills or mountains is different from driving in flat or rolling terrain.

If you drive regularly in steep country, or if you are planning to visit there, here are some tips that can make your trips safer and more enjoyable.

- Keep your vehicle in good shape. Check all fluid levels and also the brakes, tires, cooling system and transaxle. These parts can work hard on mountain roads.

- Know how to go down hills. The most important thing to know is this: let your engine do some of the slowing down. Shift to a lower gear when you go down a steep or long hill.

 **CAUTION:**

If you do not shift down, your brakes could get so hot that they would not work well. You would then have poor braking or even none going down a hill. You could crash. Shift down to let your engine assist your brakes on a steep downhill slope.

 **CAUTION:**

Coasting downhill in NEUTRAL (N) or with the ignition off is dangerous. Your brakes will have to do all the work of slowing down. They could get so hot that they would not work well.

CAUTION: (Continued)

CAUTION: (Continued)

You would then have poor braking or even none going down a hill. You could crash. Always have your engine running and your vehicle in gear when you go downhill.

- Know how to go uphill. You may want to shift down to a lower gear. The lower gears help cool your engine and transaxle, and you can climb the hill better.
- Stay in your own lane when driving on two-lane roads in hills or mountains. Do not swing wide or cut across the center of the road. Drive at speeds that let you stay in your own lane.
- As you go over the top of a hill, be alert. There could be something in your lane, like a stalled car or an accident.
- You may see highway signs on mountains that warn of special problems. Examples are long grades, passing or no-passing zones, a falling rocks area or winding roads. Be alert to these and take appropriate action.

Winter Driving



Here are some tips for winter driving:

- Have your vehicle in good shape for winter.
- You may want to put winter emergency supplies in your trunk.

Also see *Tires* on page 5-54.



Include an ice scraper, a small brush or broom, a supply of windshield washer fluid, a rag, some winter outer clothing, a small shovel, a flashlight, a red cloth and a couple of reflective warning triangles. And, if you will be driving under severe conditions, include a small bag of sand, a piece of old carpet or a couple of burlap bags to help provide traction. Be sure you properly secure these items in your vehicle.

Driving on Snow or Ice

Most of the time, those places where your tires meet the road probably have good traction.

However, if there is snow or ice between your tires and the road, you can have a very slippery situation. You will have a lot less traction or “grip” and will need to be very careful.

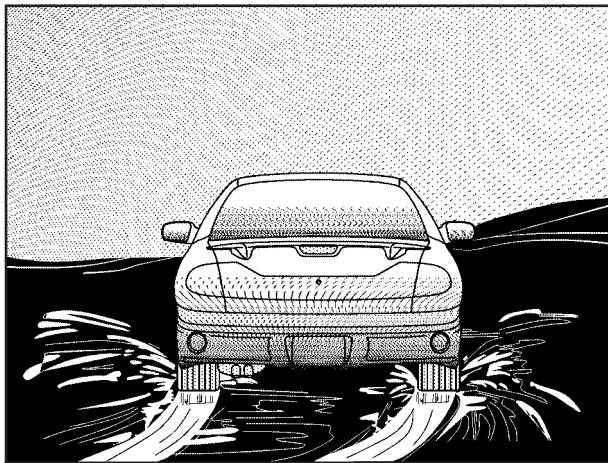

What is the worst time for this? “Wet ice.” Very cold snow or ice can be slick and hard to drive on. But wet ice can be even more trouble because it may offer the least traction of all. You can get wet ice when it is about freezing (32°F; 0°C) and freezing rain begins to fall. Try to avoid driving on wet ice until salt and sand crews can get there.

Whatever the condition — smooth ice, packed, blowing or loose snow — drive with caution.

Keep your traction control system on. It improves your ability to accelerate when driving on a slippery road. Even though your vehicle has a traction control system, you will want to slow down and adjust your driving to the road conditions. See *Traction Control System (TCS) on page 4-9*.

Unless you have the anti-lock braking system, you will want to brake very gently, too. (If you do have anti-lock, see *Braking on page 4-6*. This system improves your vehicle’s stability when you make a hard stop on a slippery road.) Whether you have the anti-lock braking system or not, you will want to begin stopping sooner than you would on dry pavement. Without anti-lock brakes, if you feel your vehicle begin to slide, let up on the brakes a little. Push the brake pedal down steadily to get the most traction you can.

Remember, unless you have anti-lock, if you brake so hard that your wheels stop rolling, you will just slide. Brake so your wheels always keep rolling and you can still steer.

- Whatever your braking system, allow greater following distance on any slippery road.
- Watch for slippery spots. The road might be fine until you hit a spot that is covered with ice. On an otherwise clear road, ice patches may appear in shaded areas where the sun can not reach: around clumps of trees, behind buildings or under bridges. Sometimes the surface of a curve or an overpass may remain icy when the surrounding roads are clear. If you see a patch of ice ahead of you, brake before you are on it. Try not to brake while you are actually on the ice, and avoid sudden steering maneuvers.

If You Are Caught in a Blizzard

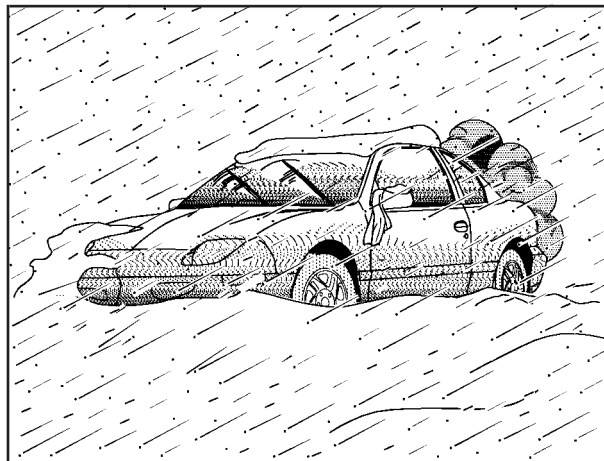

If you are stopped by heavy snow, you could be in a serious situation. You should probably stay with your vehicle unless you know for sure that you are near help and you can hike through the snow. Here are some things to do to summon help and keep yourself and your passengers safe:

- Turn on your hazard flashers.
- Tie a red cloth to your vehicle to alert police that you have been stopped by the snow.

- Put on extra clothing or wrap a blanket around you. If you have no blankets or extra clothing, make body insulators from newspapers, burlap bags, rags, floor mats — anything you can wrap around yourself or tuck under your clothing to keep warm.

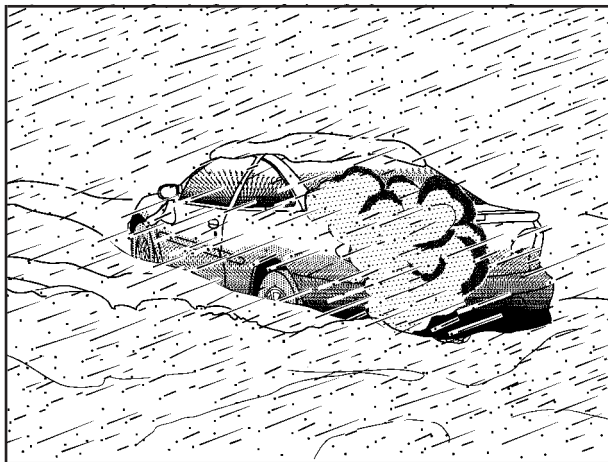

You can run the engine to keep warm, but be careful.

CAUTION:

Snow can trap exhaust gases under your vehicle. This can cause deadly CO (carbon monoxide) gas to get inside. CO could overcome you and kill you. You can not see it or smell it, so you might not know it is in your vehicle. Clear away snow from around the base of your vehicle, especially any that is blocking your exhaust pipe. And check around again from time to time to be sure snow does not collect there.

Open a window just a little on the side of the vehicle that is away from the wind. This will help keep CO out.

Run your engine only as long as you must. This saves fuel. When you run the engine, make it go a little faster than just idle. That is, push the accelerator slightly. This uses less fuel for the heat that you get and it keeps the battery charged. You will need a well-charged battery to restart the vehicle, and possibly for signaling later on with your headlamps. Let the heater run for a while.

Then, shut the engine off and close the window almost all the way to preserve the heat. Start the engine again and repeat this only when you feel really uncomfortable from the cold. But do it as little as possible. Preserve the fuel as long as you can. To help keep warm, you can get out of the vehicle and do some fairly vigorous exercises every half hour or so until help comes.

If You Are Stuck: In Sand, Mud, Ice or Snow

In order to free your vehicle when it is stuck, you will need to spin the wheels, but you do not want to spin your wheels too fast. The method known as “rocking” can help you get out when you are stuck, but you must use caution.

CAUTION:

If you let your tires spin at high speed, they can explode, and you or others could be injured. And, the transaxle or other parts of the vehicle can overheat. That could cause an engine compartment fire or other damage. When you are stuck, spin the wheels as little as possible. Do not spin the wheels above 35 mph (55 km/h) as shown on the speedometer.

Notice: Spinning your wheels can destroy parts of your vehicle as well as the tires. If you spin the wheels too fast while shifting your transaxle back and forth, you can destroy your transaxle. See “Rocking Your Vehicle To Get It Out.”

For information about using tire chains on your vehicle, see *Tire Chains* on page 5-68.

Rocking Your Vehicle To Get It Out

First, turn your steering wheel left and right. That will clear the area around your front wheels. You should turn your traction control system off. See *Traction Control System (TCS) on page 4-9*. Then shift back and forth between REVERSE (R) and a forward gear, spinning the wheels as little as possible. Release the accelerator pedal while you shift, and press lightly on the accelerator pedal when the transaxle is in gear. By slowly spinning your wheels in the forward and reverse directions, you will cause a rocking motion that may free your vehicle. If that does not get you out after a few tries, you may need to be towed out. Or, you can use your recovery hook. If you do need to be towed out, see *Towing Your Vehicle on page 4-32*.

Using the Recovery Hook

Your vehicle is equipped with a recovery hook. The recovery hook is provided at the rear of your vehicle. It can only be used for pulling your vehicle out.

CAUTION:

The recovery hook, when used, is under a lot of force. Always pull the vehicle straight out. Never pull on the hook at a sideways angle. The hook could break off and you or others could be injured from the chain or cable snapping back.

Notice: Never use the recovery hook to tow the vehicle. Your vehicle could be damaged and it would not be covered by warranty.

Towing

Towing Your Vehicle

Consult your dealer or a professional towing service if you need to have your disabled vehicle towed. See *Roadside Assistance Program on page 7-6*.

If you want to tow your vehicle behind another vehicle for recreational purposes (such as behind a motorhome), see “Recreational Vehicle Towing” following.

Recreational Vehicle Towing

Recreational vehicle towing means towing your vehicle behind another vehicle – such as behind a motorhome. The two most common types of recreational vehicle towing are known as “dinghy towing” (towing your vehicle with all four wheels on the ground) and “dolly towing” (towing your vehicle with two wheels on the ground and two wheels up on a device known as a “dolly”).

With the proper preparation and equipment, many vehicles can be towed in these ways. See “Dinghy Towing” and “Dolly Towing,” following.

Here are some important things to consider before you do recreational vehicle towing:

- What’s the towing capacity of the towing vehicle? Be sure you read the tow vehicle manufacturer’s recommendations.
- How far will you tow? Some vehicles have restrictions on how far and how long they can tow.
- Do you have the proper towing equipment? See your dealer or trailering professional for additional advice and equipment recommendations.
- Is your vehicle ready to be towed? Just as you would prepare your vehicle for a long trip, you’ll want to make sure your vehicle is prepared to be towed. See *Before Leaving on a Long Trip on page 4-23*.

Dinghy Towing

You may dinghy tow your vehicle from the front following these steps:

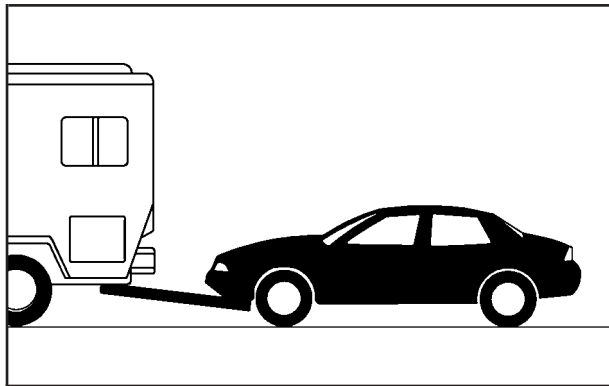

1. Set the parking brake.
2. Turn the ignition key to ACC to unlock the steering wheel.
3. Shift your transaxle to NEUTRAL (N).
4. Open the lid on the underhood fuse block and remove the IGN 0/3/CR and IGN 1/2 fuses. Refer to the underside of the underhood fuse block cover for specific fuse locations.
5. Close the lid on the underhood fuse block and store the two fuses in a safe place.

6. Close the hood.
7. Release the parking brake.

Once you have reached your destination replace the IGN 0/3/CR and IGN 1/2 fuses.

Notice: If you exceed 65 mph (110 km/h) while towing your vehicle, it could be damaged. Never exceed 65 mph (110 km/h) while towing your vehicle.

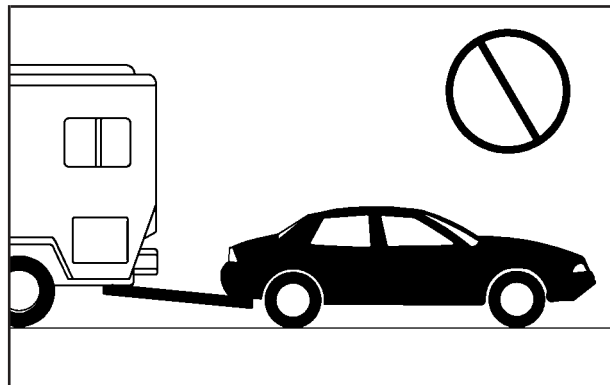

Notice: Towing your vehicle from the rear could damage it. Also, repairs would not be covered by the warranty. Never have your vehicle towed from the rear.

Dolly Towing

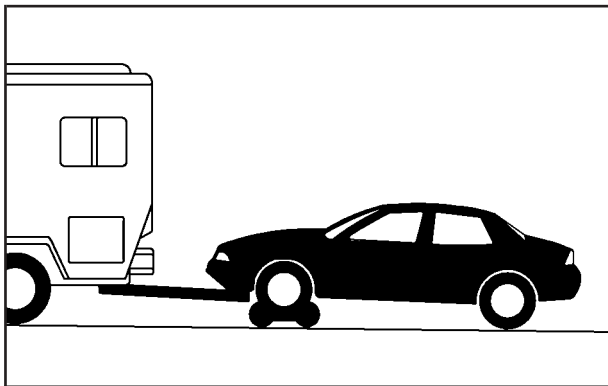

Your vehicle can be towed using a dolly. To tow your vehicle using a dolly, follow these steps:

1. Put the front wheels on a dolly.
2. Put the vehicle in PARK (P).
3. Set the parking brake and remove the key.
4. Clamp the steering wheel in a straight-ahead position with a clamping device designed for towing.
5. Release the parking brake.

Loading Your Vehicle

It is very important to know how much weight your vehicle can carry. This weight is called the vehicle capacity weight and includes the weight of all occupants, cargo and all nonfactory-installed options. Two labels on your vehicle show how much weight it may properly carry, the Tire and Loading Information label and the Certification label.

CAUTION:

Do not load your vehicle any heavier than the GVWR, or either the maximum front or rear GAWR. If you do, parts on your vehicle can break, and it can change the way your vehicle handles. These could cause you to lose control and crash. Also, overloading can shorten the life of your vehicle.

Tire and Loading Information Label

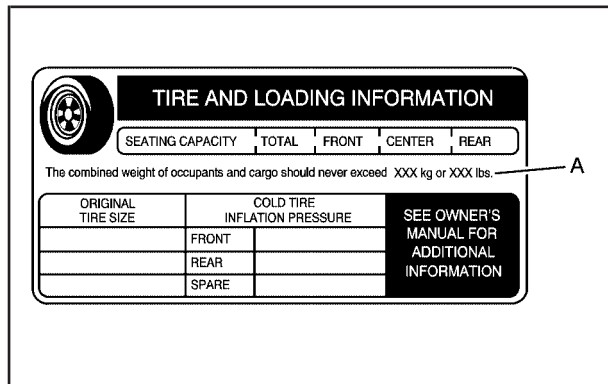

Example 1

A. Vehicle Capacity Weight

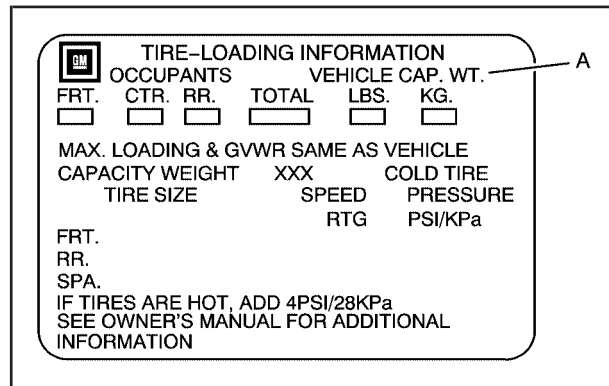

Example 2

A. Vehicle Capacity Weight

The Tire and Loading Information label shows the seating capacity and the total weight your vehicle can properly carry. This weight is called the vehicle capacity weight. If your vehicle has the Tire and Loading Information label, Example 1, the label is attached to the center pillar, near the driver's door latch. If your vehicle has the Tire-Loading Information label, Example 2, the label is on the rear edge of the driver's door.

The Tire and Loading Information label also gives you the size and recommended inflation pressure for the factory-installed, original equipment tires on your vehicle. For more information on tires and inflation see *Tires on page 5-54* and *Inflation - Tire Pressure on page 5-61*.

There is also important loading information on the Certification label. It tells you the Gross Vehicle Weight Rating (GVWR) and the Gross Axle Weight Rating (GAWR) for the front and rear axle; see "Certification Label" later in this section.

Steps for Determining Correct Load Limit

1. Locate the statement "The combined weight of occupants and cargo should never exceed XXX pounds" on your vehicle placard.
2. Determine the combined weight of the driver and passengers that will be riding in your vehicle.
3. Subtract the combined weight of the driver and passengers from XXX kilograms or XXX pounds.

4. The resulting figure equals the available amount of cargo and luggage load capacity. For example, if the "XXX" amount equals 1400 lbs. and there will be five 150 lb. passengers in your vehicle, the amount of available cargo and luggage load capacity is 650 lbs. (1400 – 750 (5 x 150) = 650 lbs.).
5. Determine the combined weight of luggage and cargo being loaded on the vehicle. That weight may not safely exceed the available cargo and luggage load capacity calculated in Step 4.
6. If your vehicle will be towing a trailer, the load from your trailer will be transferred to your vehicle. Consult this manual to determine how this reduces the available cargo and luggage load capacity of your vehicle.

If your vehicle can tow a trailer, see *Towing a Trailer on page 4-40*, for important information on towing a trailer, towing safety rules and trailering tips.

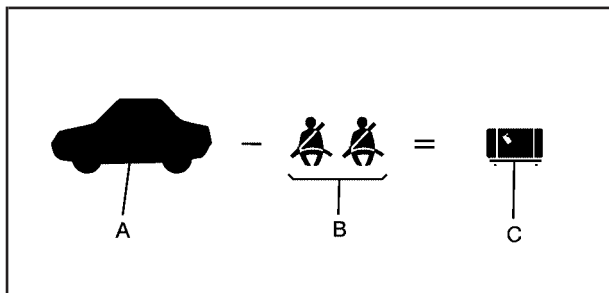

Example 1

Loading Your Vehicle

Item	Description	Total
A	Vehicle Capacity Weight for Example 1=	1,000 lbs (453 kg)
B	Subtract Occupant Weight 150 lbs (68 kg) × 2 =	300 lbs (136 kg)
C	Available Occupant and Cargo Weight =	700 lbs (317 kg)

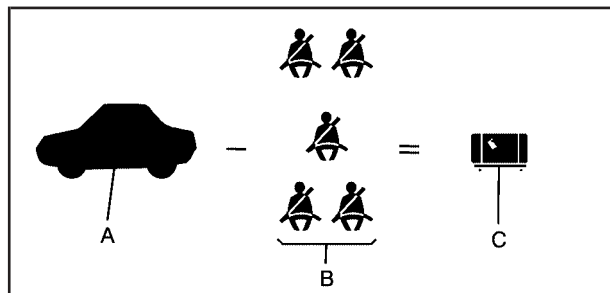

Example 2

Loading Your Vehicle

Item	Description	Total
A	Vehicle Capacity Weight for Example 2 =	1,000 lbs (453 kg)
B	Subtract Occupant Weight 150 lbs (68 kg) × 5 =	750 lbs (340 kg)
C	Available Occupant and Cargo Weight =	250 lbs (113 kg)

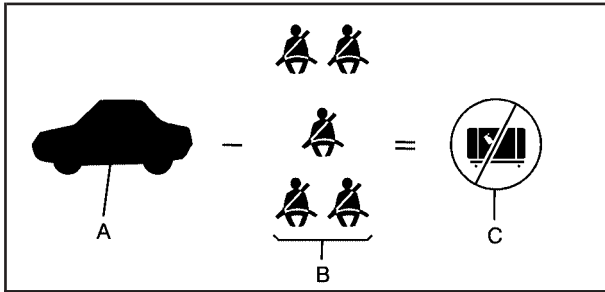

Example 3

Loading Your Vehicle

Item	Description	Total
A	Vehicle Capacity Weight for Example 3 =	1,000 lbs (453 kg)
B	Subtract Occupant Weight 200 lbs (91 kg) × 5 =	1,000 lbs (453 kg)
C	Available Occupant and Cargo Weight =	0 lbs (0 kg)

Refer to your vehicle's tire and loading information label for specific information about your vehicle's capacity weight and seating positions. The combined weight of the driver, passengers and cargo should never exceed your vehicle's capacity weight. Also see *Towing a Trailer on page 4-40*.

Certification Label

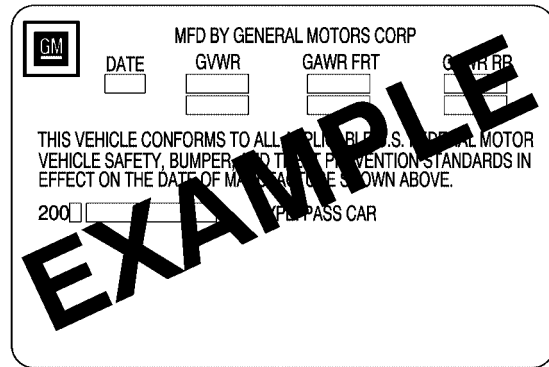

The Certification label is found on the rear edge of the driver's door. It tells you the gross weight capacity of your vehicle, called the Gross Vehicle Weight Rating (GVWR).

The GVWR includes the weight of the vehicle, all occupants, fuel and cargo. Never exceed the GVWR for your vehicle or the Gross Axle Weight Rating (GAWR) for either the front or rear axle.

If you do have a heavy load, spread it out. Don't carry more than 167 pounds (75 kg) in your trunk.

 **CAUTION:**

Do not load your vehicle any heavier than the GVWR, or either the maximum front or rear GAWR. If you do, parts on your vehicle can break, and it can change the way your vehicle handles. These could cause you to lose control and crash. Also, overloading can shorten the life of your vehicle.

Notice: Overloading your vehicle may cause damage. Repairs would not be covered by your warranty. Do not overload your vehicle.

If you put things inside your vehicle — like suitcases, tools, packages or anything else — they will go as fast as the vehicle goes. If you have to stop or turn quickly, or if there is a crash, they'll keep going.

 **CAUTION:**

Things you put inside your vehicle can strike and injure people in a sudden stop or turn, or in a crash.

- **Put things in the trunk of your vehicle. In a trunk, put them as far forward as you can. Try to spread the weight evenly.**
- **Never stack heavier things, like suitcases, inside the vehicle so that some of them are above the tops of the seats.**
- **Do not leave an unsecured child restraint in your vehicle.**
- **When you carry something inside the vehicle, secure it whenever you can.**
- **Do not leave a seat folded down unless you need to.**

Towing a Trailer

CAUTION:

If you do not use the correct equipment and drive properly, you can lose control when you pull a trailer. For example, if the trailer is too heavy, the brakes may not work well — or even at all. You and your passengers could be seriously injured. You may also damage your vehicle; the resulting repairs would not be covered by your warranty. Pull a trailer only if you have followed all the steps in this section. Ask your dealer for advice and information about towing a trailer with your vehicle.

Your vehicle can tow a trailer if it is equipped with the proper trailer towing equipment. To identify what the vehicle trailering capacity is for your vehicle, you should read the information in “Weight of the Trailer” that appears later in this section. But trailering is different than just driving your vehicle by itself. Trailering means changes in handling, durability and fuel economy. Successful, safe trailering takes correct equipment, and it has to be used properly.

That’s the reason for this part. In it are many time-tested, important trailering tips and safety rules. Many of these are important for your safety and that of your passengers. So please read this section carefully before you pull a trailer.

Load-pulling components such as the engine, transaxle, rear axle, wheel assemblies and tires are forced to work harder against the drag of the added weight. The engine is required to operate at relatively higher speeds and under greater loads, generating extra heat. What’s more, the trailer adds considerably to wind resistance, increasing the pulling requirements.

If You Do Decide to Pull a Trailer

If you do, here are some important points:

- There are many different laws, including speed limit restrictions, having to do with trailering. Make sure your rig will be legal, not only where you live but also where you'll be driving. A good source for this information can be state or provincial police.
- Consider using a sway control. You can ask a hitch dealer about sway controls.
- Do not tow a trailer at all during the first 500 miles (805 km) your new vehicle is driven. Your engine, axle or other parts could be damaged.
- Then, during the first 500 miles (805 km) that you tow a trailer, do not drive over 50 mph (80 km/h) and do not make starts at full throttle. This helps your engine and other parts of your vehicle wear in at the heavier loads.
- Obey speed limit restrictions when towing a trailer. Do not drive faster than the maximum posted speed for trailers, or no more than 55 mph (90 km/h), to save wear on your vehicle's parts.

Three important considerations have to do with weight:

- the weight of the trailer,
- the weight of the trailer tongue
- and the total weight on your vehicle's tires.

Weight of the Trailer

How heavy can a trailer safely be?

It should never weigh more than 1,000 lbs. (454 kg). But even that can be too heavy.

It depends on how you plan to use your rig. For example, speed, altitude, road grades, outside temperature and how much your vehicle is used to pull a trailer are all important. And, it can also depend on any special equipment that you have on your vehicle.

You can ask your dealer for our trailering information or advice, or you can write us at:

Saturn Customer Assistance Center
100 Saturn Parkway
Mail Code 371-999-S24
Spring Hill, TN 37174-1500

In Canada, write to:

Saturn Customer Communication Centre
General Motors of Canada, Ltd.,
1908 Colonel Sam Drive
Oshawa,
Ontario L1H 8P7

Weight of the Trailer Tongue

The tongue load (A) of any trailer is an important weight to measure because it affects the total or gross weight of your vehicle. The Gross Vehicle Weight (GVW) includes the curb weight of the vehicle, any cargo you may carry in it, and the people who will be riding in the vehicle. And if you tow a trailer, you must add the tongue load to the GVW because your vehicle will be carrying that weight, too. See *Loading Your Vehicle on page 4-34* for more information about your vehicle's maximum load capacity.

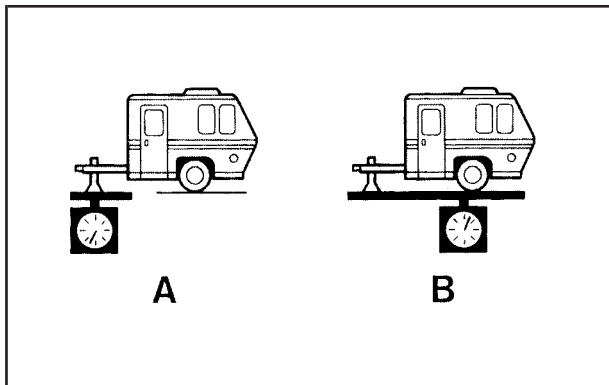

If you are using a weight-carrying hitch or a weight-distributing hitch, the trailer tongue (A) should weigh 10 to 15 percent of the total loaded trailer weight (B).

After you have loaded your trailer, weigh the trailer and then the tongue, separately, to see if the weights are proper. If they are not, you may be able to get them right simply by moving some items around in the trailer.

Total Weight on Your Vehicle's Tires

Be sure your vehicle's tires are inflated to the upper limit for cold tires. You will find these numbers on the Tire-Loading Information label, See *Loading Your Vehicle on page 4-34*. Then be sure you do not go over the GVW limit for your vehicle, including the weight of the trailer tongue.

Hitches

It's important to have the correct hitch equipment. Crosswinds, large trucks going by and rough roads are a few reasons why you will need the right hitch. Here are some rules to follow:

- The rear bumper on your vehicle is not intended for hitches. Do not attach rental hitches or other bumper-type hitches to it. Use only a frame-mounted hitch that does not attach to the bumper.
- Will you have to make any holes in the body of your vehicle when you install a trailer hitch? If you do, then be sure to seal the holes later when you remove the hitch. If you don't seal them, deadly carbon monoxide (CO) from your exhaust can get into your vehicle. See *Engine Exhaust* on page 2-31. Dirt and water can, too.

Safety Chains

You should always attach chains between your vehicle and your trailer. Cross the safety chains under the tongue of the trailer so that the tongue will not drop to the road if it becomes separated from the hitch. Instructions about safety chains may be provided by the hitch manufacturer or by the trailer manufacturer. Follow the manufacturer's recommendation for attaching safety chains and do not attach them to the bumper. Always leave just enough slack so you can turn with your rig. And, never allow safety chains to drag on the ground.

Trailer Brakes

Because your vehicle has anti-lock brakes, do not try to tap into your vehicle's hydraulic brake system. If you do, both brake systems will not work well, or at all.

Be sure to read and follow the instructions for the trailer brakes so you'll be able to install, adjust and maintain them properly.

Driving with a Trailer

Towing a trailer requires a certain amount of experience. Before setting out for the open road, you will want to get to know your rig. Acquaint yourself with the feel of handling and braking with the added weight of the trailer. And always keep in mind that the vehicle you are driving is now a good deal longer and not nearly as responsive as your vehicle is by itself.

Before you start, check the trailer hitch and platform (and attachments), safety chains, electrical connector, lamps, tires and mirror adjustment. If the trailer has electric brakes, start your vehicle and trailer moving and then apply the trailer brake controller by hand to be sure the brakes are working. This lets you check your electrical connection at the same time.

During your trip, check occasionally to be sure that the load is secure, and that the lamps and any trailer brakes are still working.

Following Distance

Stay at least twice as far behind the vehicle ahead as you would when driving your vehicle without a trailer. This can help you avoid situations that require heavy braking and sudden turns.

Passing

You'll need more passing distance up ahead when you're towing a trailer. And, because you're a good deal longer, you'll need to go much farther beyond the passed vehicle before you can return to your lane.

Backing Up

Hold the bottom of the steering wheel with one hand. Then, to move the trailer to the left, just move that hand to the left. To move the trailer to the right, move your hand to the right. Always back up slowly and, if possible, have someone guide you.

Making Turns

Notice: Making very sharp turns while trailering could cause the trailer to come in contact with the vehicle. Your vehicle could be damaged. Avoid making very sharp turns while trailering.

When you're turning with a trailer, make wider turns than normal. Do this so your trailer won't strike soft shoulders, curbs, road signs, trees or other objects. Avoid jerky or sudden maneuvers. Signal well in advance.

Turn Signals When Towing a Trailer

When you tow a trailer, your vehicle may need a different turn signal flasher and/or extra wiring. Check with your dealer. The arrows on your instrument panel will flash whenever you signal a turn or lane change. Properly hooked up, the trailer lamps will also flash, telling other drivers you're about to turn, change lanes or stop.

When towing a trailer, the arrows on your instrument panel will flash for turns even if the bulbs on the trailer are burned out. Thus, you may think drivers behind you are seeing your signal when they are not. It's important to check occasionally to be sure the trailer bulbs are still working.

Driving on Grades

Reduce speed and shift to a lower gear before you start down a long or steep downgrade. If you do not shift down, you might have to use your brakes so much that they would get hot and no longer work well.

On a long uphill grade, shift down and reduce your speed to around 45 mph (70 km/h) to reduce the possibility of the engine and the transaxle overheating.

Parking on Hills

CAUTION:

You really should not park your vehicle, with a trailer attached, on a hill. If something goes wrong, your rig could start to move. People can be injured, and both your vehicle and the trailer can be damaged.

But if you ever have to park your rig on a hill, here's how to do it:

1. Apply your regular brakes, but don't shift into PARK (P).
When parking uphill, turn your wheels away from the curb. When parking downhill, turn your wheels into the curb.
2. Have someone place chocks behind the trailer wheels.
3. When the chocks are in place, release the regular brakes until the chocks absorb the load.
4. Reapply the regular brakes. Then apply your parking brake and shift into PARK (P).
5. Release the regular brakes.

When You Are Ready to Leave After Parking on a Hill

1. Apply your regular brakes and hold the pedal down while you:
 - start your engine,
 - shift into a gear, and
 - release the parking brake.
2. Let up on the brake pedal.
3. Drive slowly until the trailer is clear of the chocks.
4. Stop and have someone pick up and store the chocks.

Maintenance When Trailer Towing

Your vehicle will need service more often when you're pulling a trailer. See the Maintenance Schedule for more information. Things that are especially important in trailer operation are automatic transaxle fluid (do not overfill), engine oil, axle lubricant, drive belt, cooling system and brake system. Each of these is covered in this manual, and the Index will help you find them quickly. If you're trailering, it's a good idea to review this information before you start your trip.

Check periodically to see that all hitch nuts and bolts are tight.

Engine Cooling When Trailer Towing

Your cooling system may temporarily overheat during severe operating conditions. See *Engine Overheating on page 5-26*.

Section 5 Service and Appearance Care

Service	5-3	Battery	5-39
Doing Your Own Service Work	5-4	Jump Starting	5-40
Adding Equipment to the Outside of Your Vehicle	5-5	Bulb Replacement	5-46
Fuel	5-5	Halogen Bulbs	5-46
Gasoline Octane	5-5	Headlamps, Front Turn Signal, Sidemarker, and Parking Lamps	5-47
Gasoline Specifications	5-6	Fog Lamps	5-49
California Fuel	5-6	Center High-Mounted Stoplamp (CHMSL) (Sedan)	5-49
Additives	5-7	Center High-Mounted Stoplamp (CHMSL) (Wagon)	5-50
Fuels in Foreign Countries	5-7	Taillamps, Turn Signal, Stoplamps and Back-up Lamps (Sedan)	5-50
Filling Your Tank	5-8	Taillamps, Turn Signal, Stoplamps and Back-up Lamps (Wagon)	5-52
Filling a Portable Fuel Container	5-9	Replacement Bulbs	5-52
Checking Things Under the Hood	5-10	Windshield Wiper Blade Replacement	5-53
Hood Release	5-10	Tires	5-54
Engine Compartment Overview	5-12	Inflation - Tire Pressure	5-61
Engine Oil	5-16	Tire Inspection and Rotation	5-62
Engine Air Cleaner/Filter	5-20	When It Is Time for New Tires	5-64
Automatic Transaxle Fluid	5-23	Buying New Tires	5-64
Engine Coolant	5-23	Uniform Tire Quality Grading	5-65
Coolant Surge Tank Pressure Cap	5-26	Wheel Alignment and Tire Balance	5-67
Engine Overheating	5-26	Wheel Replacement	5-67
Cooling System	5-29		
Power Steering Fluid	5-34		
Windshield Washer Fluid	5-35		
Brakes	5-36		

Section 5 Service and Appearance Care

Tire Chains	5-68	Chemical Paint Spotting	5-88
If a Tire Goes Flat	5-69	Vehicle Care/Appearance Materials	5-89
Changing a Flat Tire	5-70	Vehicle Identification	5-90
Compact Spare Tire	5-81	Vehicle Identification Number (VIN)	5-90
Appearance Care	5-82	Service Parts Identification Label	5-91
Cleaning the Inside of Your Vehicle	5-82	Electrical System	5-91
Care of Safety Belts	5-85	Add-On Electrical Equipment	5-91
Weatherstrips	5-85	Windshield Wiper Fuses	5-91
Cleaning the Outside of Your Vehicle	5-85	Power Windows and Other Power Options	5-92
Sheet Metal Damage	5-87	Fuses and Circuit Breakers	5-92
Finish Damage	5-88	Capacities and Specifications	5-98
Underbody Maintenance	5-88		

Service

Your Saturn retailer knows your vehicle best and wants you to be happy with it. We hope you will go to your retailer for all your service needs. You will get genuine Saturn parts and Saturn-trained and supported service people.

We hope you will want to keep your Saturn vehicle all Saturn.

Genuine Saturn parts have one of these marks.

ACDelco[®]



California Proposition 65 Warning

Most motor vehicles, including this one, contain and/or emit chemicals known to the State of California to cause cancer and birth defects or other reproductive harm. Engine exhaust, many parts and systems (including some inside the vehicle), many fluids, and some component wear by-products contain and/or emit these chemicals.

Doing Your Own Service Work

If you want to do some of your own service work, you will want to use the proper service manual. It tells you much more about how to service your vehicle than this manual can. To order the proper service manual, see *Service Publications Ordering Information on page 7-10*.

Your vehicle has an air bag system. Before attempting to do your own service work, see *Servicing Your Air Bag-Equipped Vehicle on page 1-71*.

You should keep a record with all parts receipts and list the mileage and the date of any service work you perform. See *Maintenance Record on page 6-15*.

CAUTION:

You can be injured and your vehicle could be damaged if you try to do service work on a vehicle without knowing enough about it.

- **Be sure you have sufficient knowledge, experience, the proper replacement parts and tools before you attempt any vehicle maintenance task.**
- **Be sure to use the proper nuts, bolts and other fasteners. “English” and “metric” fasteners can be easily confused. If you use the wrong fasteners, parts can later break or fall off. You could be hurt.**

Adding Equipment to the Outside of Your Vehicle

Things you might add to the outside of your vehicle can affect the airflow around it. This may cause wind noise and affect windshield washer performance. Check with your retailer before adding equipment to the outside of your vehicle.

Fuel

Use of the recommended fuel is an important part of the proper maintenance of your vehicle.

Gasoline Octane

Use regular unleaded gasoline with a posted octane of 87 or higher. If the octane is less than 87, you may get a heavy knocking noise when you drive. If this occurs, use a gasoline rated at 87 octane or higher as soon as possible. Otherwise, you might damage your engine. A little pinging noise when you accelerate or drive uphill is considered normal. This does not indicate a problem exists or that a higher-octane fuel is necessary. If you are using 87 octane or higher-octane fuel and hear heavy knocking, your engine needs service.

Gasoline Specifications

It is recommended that gasoline meet specifications which were developed by automobile manufacturers around the world and contained in the World-Wide Fuel Charter which is available from the Alliance of Automobile Manufacturers at www.autoalliance.org/fuel_charter.htm. Gasoline meeting these specifications could provide improved driveability and emission control system performance compared to other gasoline.



Canada Only

In Canada, look for the “Auto Makers’ Choice” label on the pump.

California Fuel

If your vehicle is certified to meet California Emission Standards (see the underhood emission control label), it is designed to operate on fuels that meet California specifications. If this fuel is not available in states adopting California emissions standards, your vehicle will operate satisfactorily on fuels meeting federal specifications, but emission control system performance may be affected. The malfunction indicator lamp may turn on (see *Malfunction Indicator Lamp on page 3-34*) and your vehicle may fail a smog-check test. If this occurs, return to your authorized Saturn retailer for diagnosis. If it is determined that the condition is caused by the type of fuel used, repairs may not be covered by your warranty.

Additives

To provide cleaner air, all gasolines in the United States are now required to contain additives that will help prevent engine and fuel system deposits from forming, allowing your emission control system to work properly. You should not have to add anything to your fuel. However, some gasolines contain only the minimum amount of additive required to meet U.S. Environmental Protection Agency regulations. General Motors recommends that you buy gasolines that are advertised to help keep fuel injectors and intake valves clean. If your vehicle experiences problems due to dirty injectors or valves, try a different brand of gasoline.

Gasolines containing oxygenates, such as ethers and ethanol, and reformulated gasolines may be available in your area to contribute to clean air. General Motors recommends that you use these gasolines, particularly if they comply with the specifications described earlier.

Notice: Your vehicle was not designed for fuel that contains methanol. Do not use fuel containing methanol. It can corrode metal parts in your fuel system and also damage the plastic and rubber parts. That damage would not be covered under your warranty.

Some gasolines that are not reformulated for low emissions may contain an octane-enhancing additive called methylcyclopentadienyl manganese tricarbonyl (MMT); ask the attendant where you buy gasoline whether the fuel contains MMT. General Motors does not recommend the use of such gasolines. Fuels containing MMT can reduce the life of spark plugs and the performance of the emission control system may be affected. The malfunction indicator lamp may turn on. If this occurs, return to your authorized Saturn retailer for service.

Fuels in Foreign Countries

If you plan on driving in another country outside the United States or Canada, the proper fuel may be hard to find. Never use leaded gasoline or any other fuel not recommended in the previous text on fuel. Costly repairs caused by use of improper fuel would not be covered by your warranty.

To check the fuel availability, ask an auto club, or contact a major oil company that does business in the country where you will be driving.

Filling Your Tank

CAUTION:

Fuel vapor burns violently and a fuel fire can cause bad injuries. To help avoid injuries to you and others, read and follow all the instructions on the pump island. Turn off your engine when you are refueling. Do not smoke if you are near fuel or refueling your vehicle. Keep sparks, flames and smoking materials away from fuel. Do not leave the fuel pump unattended when refueling your vehicle — this is against the law in some places. Keep children away from the fuel pump; never let children pump fuel.



The fuel filler cap is located behind a hinged door on the passenger's side of your vehicle. It is tethered to the door to prevent loss while refueling. Make sure that water, snow, and dirt are kept away from the filler cap and filler pipe nozzle.

To remove the fuel cap, turn it slowly to the left (counterclockwise). It will require about 1/2 of a turn to remove the cap. The fuel cap has a spring in it; if you let go of the cap too soon, it will spring back to the right (clockwise).

CAUTION:

If you get fuel on yourself and then something ignites it, you could be badly burned. Fuel can spray out on you if you open the fuel cap too quickly.

CAUTION: (Continued)

CAUTION: (Continued)

This spray can happen if your tank is nearly full, and is more likely in hot weather. Open the fuel cap slowly and wait for any “hiss” noise to stop. Then unscrew the cap all the way.

Be careful not to spill fuel. Clean fuel from painted surfaces as soon as possible. See *Cleaning the Outside of Your Vehicle* on page 5-85.

When you put the fuel cap back on, turn it to the right (clockwise) about 1/4 of a turn until you hear three clicks. Make sure you fully install the cap. The diagnostic system can determine if the fuel cap has been left off or improperly installed. This would allow fuel to evaporate into the atmosphere and may cause the malfunction indicator lamp to come on. See *Malfunction Indicator Lamp* on page 3-34.

Notice: If you need a new fuel cap, be sure to get the right type. Your dealer can get one for you. If you get the wrong type, it may not fit properly. This may cause your malfunction indicator lamp to light and may damage your fuel tank and emissions system. See *Malfunction Indicator Lamp* on page 3-34.

Filling a Portable Fuel Container

CAUTION:

Never fill a portable fuel container while it is in your vehicle. Static electricity discharge from the container can ignite the gasoline vapor. You can be badly burned and your vehicle damaged if this occurs. To help avoid injury to you and others:

- Dispense gasoline only into approved containers.
- Do not fill a container while it is inside a vehicle, in a vehicle's trunk, pickup bed or on any surface other than the ground.
- Bring the fill nozzle in contact with the inside of the fill opening before operating the nozzle. Contact should be maintained until the filling is complete.
- Do not smoke while pumping gasoline.

Checking Things Under the Hood

CAUTION:

An electric fan under the hood can start up and injure you even when the engine is not running. Keep hands, clothing and tools away from any underhood electric fan.

CAUTION:

Things that burn can get on hot engine parts and start a fire. These include liquids like fuel, oil, coolant, brake fluid, windshield washer and other fluids, and plastic or rubber. You or others could be burned. Be careful not to drop or spill things that will burn onto a hot engine.

Hood Release

To open the hood, do the following:



1. Pull the handle located inside the vehicle.



2. Then go to the front of the vehicle and lift up on the secondary hood release lever.



3. Lift the hood, release the hood prop from its retainer and put the hood prop into the slot in the hood.

Before closing the hood, be sure all the filler caps are on properly. Then lift the hood to relieve pressure on the hood prop. Remove the hood prop from the slot in the hood and return the prop to its retainer. Then just let the hood down and close it firmly.

Engine Compartment Overview

When you open the hood on the 2.2L L4 (L61) engine, you'll see the following:

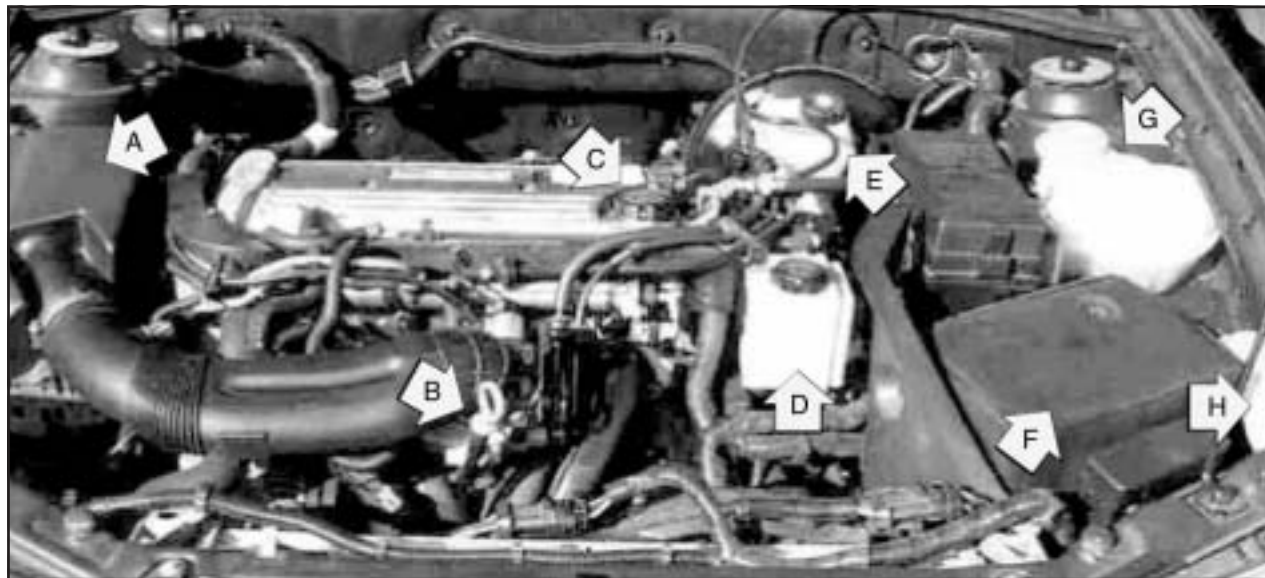

- A. Engine Air Cleaner/Filter. See *Engine Air Cleaner/Filter* on page 5-20 for more information.
 - B. Engine Oil Dipstick. See *Engine Oil* on page 5-16 for more information.
 - C. Engine Oil Fill Cap. See *Engine Oil* on page 5-16 for more information.
 - D. Power Steering Fluid. See *Power Steering Fluid* on page 5-34 for more information.
 - E. Brake Master Cylinder Fluid. See *Brakes* on page 5-36 for more information.
 - F. Battery. See *Battery* on page 5-39 for more information.
 - G. Engine Coolant Recovery Tank. See *Engine Coolant* on page 5-23 for more information.
 - H. Windshield Washer Fluid Reservoir. See *Windshield Washer Fluid* on page 5-35 for more information.
- Before closing the hood, be sure all filler caps are on properly.

When you open the hood on the 3.0L V6 (L81) engine, you'll see the following:

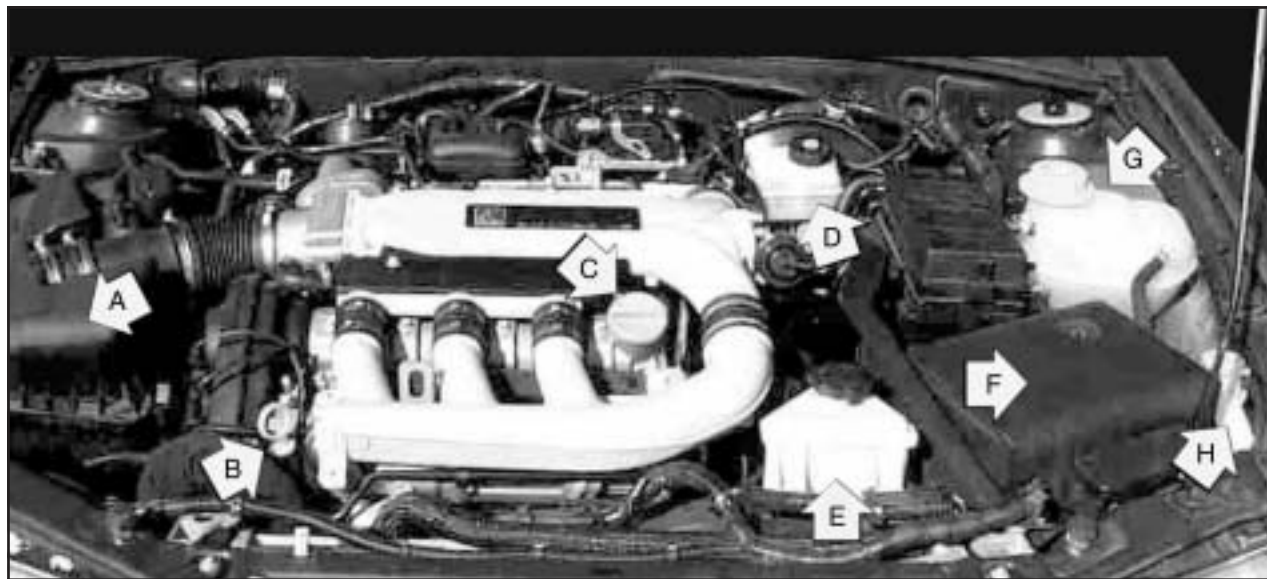

- A. Engine Air Cleaner/Filter. See *Engine Air Cleaner/Filter* on page 5-20 for more information.
 - B. Engine Oil Dipstick. See *Engine Oil* on page 5-16 for more information.
 - C. Engine Oil Fill Cap. See *Engine Oil* on page 5-16 for more information.
 - D. Brake Master Cylinder Fluid. See *Brakes* on page 5-36 for more information.
 - E. Power Steering Fluid. See *Power Steering Fluid* on page 5-34 for more information.
 - F. Battery. See *Battery* on page 5-39 for more information.
 - G. Engine Coolant Recovery Tank. See *Engine Coolant* on page 5-23 for more information.
 - H. Windshield Washer Fluid Reservoir. See *Windshield Washer Fluid* on page 5-35 for more information.
- Before closing the hood, be sure all filler caps are on properly.

Engine Oil

Checking Engine Oil

It is a good idea to check your engine oil every time you get fuel. In order to get an accurate reading, the oil must be warm and the vehicle must be on level ground.

The engine oil dipstick handle is a yellow loop. See *Engine Compartment Overview on page 5-12* for the location of the engine oil dipstick

Turn off the engine and give the oil several minutes to drain back into the oil pan. If you don't, the oil dipstick might not show the actual level.

Pull out the dipstick and clean it with a paper towel or cloth, then push it back in all the way. Remove it again, keeping the tip down, and check the level.



2.2L L4 (L61) Dipstick Shown, 3.0L V6 (L81) Similar

When to Add Engine Oil

If the oil is at or below the MIN mark, then you will need to add at least one quart of oil. But you must use the right kind. This section explains what kind of oil to use. For engine oil crankcase capacity, see *Capacities and Specifications on page 5-98*.

Notice: Do not add too much oil. If your engine has so much oil that the oil level gets above the upper mark that shows the proper operating range, your engine could be damaged.



2.2L L4 (L61) Engine

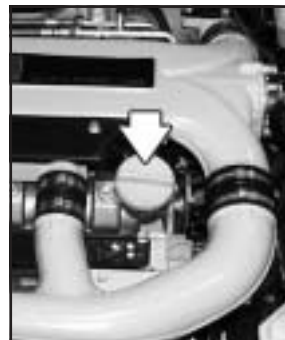

3.0L V6 (L81) Engine

See *Engine Compartment Overview* on page 5-12 for the location of the engine oil fill cap.

Be sure to add enough oil to put the level somewhere in the proper operating range. Push the dipstick all the way back in when you are through.

What Kind of Engine Oil to Use

Look for two things:

- GM6094M

Your vehicle's engine requires oil meeting GM Standard GM6094M. You should look for and use only an oil that meets GM Standard GM6094M.

RECOMMENDED SAE VISCOSITY GRADE ENGINE OILS

HOT WEATHER

COLD WEATHER

LOOK FOR THIS SYMBOL AND GM STANDARD GM 6094M

SAE 5W-30 RECOMMENDED

SAE 10W-30 ACCEPTABLE IF 5W-30 IS NOT AVAILABLE

DO NOT USE SAE 10W-40, SAE 20W-50 OR ANY OTHER VISCOSITY GRADE OIL NOT RECOMMENDED

- SAE 5W-30

As shown in the viscosity chart, SAE 5W-30 is best for your vehicle. However, if it is going to be 0°F (-18°C) or above and SAE 5W-30 is not available, you may use SAE 10W-30.

These numbers on an oil container show its viscosity, or thickness. Do not use other viscosity oils such as SAE 20W-50.



Oils meeting these requirements should also have the starburst symbol on the container. This symbol indicates that the oil has been certified by the American Petroleum Institute (API).

You should look for this information on the oil container, and use *only* those oils that are identified as meeting GM Standard GM6094M and have the starburst symbol on the front of the oil container.

Notice: Use only engine oil identified as meeting GM Standard GM6094M and showing the American Petroleum Institute Certified For Gasoline Engines starburst symbol. Failure to use the recommended oil can result in engine damage not covered by your warranty.

If you are in an area of extreme cold, where the temperature falls below -20°F (-29°C), it is recommended that you use either an SAE 5W-30 synthetic oil or an SAE 0W-30 oil. Both will provide easier cold starting and better protection for your engine at extremely low temperatures.

Engine Oil Additives

Do not add anything to your oil. The recommended oils with the starburst symbol that meet GM Standard GM6094M are all you will need for good performance and engine protection.

When to Change Engine Oil (GM Oil Life System)

Your vehicle has a computer system that lets you know when to change the engine oil and filter. This is based on engine revolutions and engine temperature, and not on mileage. Based on driving conditions, the mileage at which an oil change will be indicated can vary considerably. For the oil life system to work properly, you must reset the system every time the oil is changed.

When the system has calculated that oil life has been diminished, it will indicate that an oil change is necessary. A Change Engine Oil light will come on. Change your oil as soon as possible within the next two times you stop for fuel. It is possible that, if you are driving under the best conditions, the oil life system may not indicate that an oil change is necessary for over a year. However, your engine oil and filter must be changed at least once a year and at this time the system must be reset. Your retailer has trained service people who will perform this work using genuine Saturn parts and reset the system. It is also important to check your oil regularly and keep it at the proper level.

If the system is ever reset accidentally, you must change your oil at 3,000 miles (5 000 km) since your last oil change. Remember to reset the oil life system whenever the oil is changed.

How to Reset the Oil Life System

The GM Oil Life System calculates when to change your engine oil and filter based on vehicle use. Anytime your oil is changed, reset the system so it can calculate when the next oil change is required. If a situation occurs where you change your oil prior to a Change Engine Oil light being turned on, reset the system.

After changing the engine oil, reset the system by performing the following steps:

1. Turn the ignition key to RUN with the engine off.
2. Fully press and release the accelerator pedal three times within five seconds.

If the Change Engine Oil light is flashing, the system is reset. The light will flash for up to 30 seconds or until the ignition is turned off.

If the light comes on again and stays on for 30 seconds at the next ignition cycle, it did not reset. You will need to reset the system again.

What to Do with Used Oil

Used engine oil contains certain elements that may be unhealthy for your skin and could even cause cancer. Do not let used oil stay on your skin for very long. Clean your skin and nails with soap and water, or a good hand cleaner. Wash or properly dispose of clothing or rags containing used engine oil. See the manufacturer's warnings about the use and disposal of oil products.

Used oil can be a threat to the environment. If you change your own oil, be sure to drain all the oil from the filter before disposal. Never dispose of oil by putting it in the trash, pouring it on the ground, into sewers, or into streams or bodies of water. Instead, recycle it by taking it to a place that collects used oil. If you have a problem properly disposing of your used oil, ask your dealer, a service station or a local recycling center for help.

Engine Air Cleaner/Filter

When to Inspect the Engine Air Cleaner/Filter

Inspect the air cleaner/filter every 15,000 miles (25 000 km) and replace every 30,000 miles (50 000 km). If you are driving in dusty/dirty conditions, inspect the filter at each engine oil change.

How to Inspect the Engine Air Cleaner/Filter

To inspect the air cleaner/filter, remove the filter from the vehicle and lightly shake filter to release loose dust and dirt. If the filter remains "caked" with dirt, a new filter is required.

See *Engine Compartment Overview on page 5-12* for location of air cleaner/filter.

⚠ CAUTION:

Operating the engine with the air cleaner/filter off can cause you or others to be burned. The air cleaner not only cleans the air, it helps to stop flame if the engine backfires. If it is not there and the engine backfires, you could be burned. Do not drive with it off, and be careful working on the engine with the air cleaner/filter off.

Notice: If the air cleaner/filter is off, a backfire can cause a damaging engine fire. And, dirt can easily get into your engine, which will damage it. Always have the air cleaner/filter in place when you are driving.

If you want to replace the engine air cleaner/filter yourself, use the following steps.



1. Remove the hose clamp that is on the inlet duct on the cover and pull off the hose.
2. Release the two clips and turn the cover upward to unhook the hinges.



3. Pull the air cleaner/filter box cover out and remove the air filter element from the air filter box. If the element is dirty, you should replace it. If the element is only dusty, it may be cleaned by blowing compressed air through it from the clean side. Make sure you are away from your engine compartment when cleaning the air filter with compressed air.

4. Wipe all dust from inside the housing and inspect the air cleaner and air inlet tube for cracks, cuts and deterioration. The air inlet tube must be replaced if it is damaged.
5. Install the air filter element, hose, hose clamp and cover.
6. Latch the two clips.

Automatic Transaxle Fluid

It is not necessary to check the transaxle fluid level. A transaxle fluid leak is the only reason for fluid loss. If a leak occurs, take the vehicle to retailer's service department and have it repaired as soon as possible. You may also have your fluid level checked by your retailer or service center when you have your oil changed.

Change both the fluid and filter every 50,000 miles (83 000 km) if the vehicle is mainly driven under one or more of these conditions:

- In heavy city traffic where the outside temperature regularly reaches 90°F (32°C) or higher.
- In hilly or mountainous terrain.
- When doing frequent trailer towing.
- Uses such as found in taxi, police or delivery service.

If you do not use your vehicle under any of these conditions, the fluid and filter do not require changing.

Notice: Use of automatic transaxle fluid labeled other than DEXRON®-III may damage your vehicle, and the damages may not be covered by your warranty. Always use DEXRON®-III labeled automatic transaxle fluid.

Engine Coolant

The cooling system in your vehicle is filled with DEX-COOL® engine coolant. This coolant is designed to remain in your vehicle for five years or 100,000 miles (166 000 km), whichever occurs first, if you add only DEX-COOL® extended life coolant.

The following explains your cooling system and how to add coolant when it is low. If you have a problem with engine overheating, see *Engine Overheating on page 5-26*.

A 50/50 mixture of clean, drinkable water and DEX-COOL® coolant will:

- Give freezing protection down to -34°F (-37°C).
- Give boiling protection up to 265°F (129°C).
- Protect against rust and corrosion.
- Help keep the proper engine temperature.
- Let the warning lights and gages work as they should.

Notice: Using coolant other than DEX-COOL® may cause premature engine, heater core or radiator corrosion. In addition, the engine coolant may require changing sooner, at 30,000 miles (50 000 km) or 24 months, whichever occurs first. Any repairs would not be covered by your warranty. Always use DEX-COOL®(silicate-free) coolant in your vehicle.

What to Use

Use a mixture of one-half *clean, drinkable water* and one-half DEX-COOL[®] coolant which won't damage aluminum parts. If you use this coolant mixture, you don't need to add anything else.

CAUTION:

Adding only plain water to your cooling system can be dangerous. Plain water, or some other liquid such as alcohol, can boil before the proper coolant mixture will. Your vehicle's coolant warning system is set for the proper coolant mixture. With plain water or the wrong mixture, your engine could get too hot but you would not get the overheat warning. Your engine could catch fire and you or others could be burned. Use a 50/50 mixture of clean, drinkable water and DEX-COOL[®] coolant.

Notice: If you use an improper coolant mixture, your engine could overheat and be badly damaged. The repair cost would not be covered by your warranty. Too much water in the mixture can freeze and crack the engine, radiator, heater core and other parts.

If you have to add coolant more than four times a year, have your retailer check your cooling system.

Notice: If you use the proper coolant, you do not have to add extra inhibitors or additives which claim to improve the system. These can be harmful.

Checking Coolant



The surge tank is located on the driver's side of the engine compartment. See *Engine Compartment Overview* on page 5-12 for more information on location.



The vehicle must be on a level surface. When your engine is cold, the coolant level should be at the Cold line (surge tank seam). When your engine is warm, the level should be at the Cold line or a little higher.

If the low coolant light comes on and stays on, it means you're low on engine coolant. See *Low Coolant Warning Light* on page 3-33.

CAUTION:

Turning the surge tank pressure cap when the engine and radiator are hot can allow steam and scalding liquids to blow out and burn you badly. Never turn the surge tank pressure cap — even a little — when the engine and radiator are hot.

Adding Coolant

If you need more coolant, add the proper DEX-COOL[®] coolant mixture *at the surge tank*, but only when the engine is cool. See *Engine Overheating on page 5-26* for instructions on “How to Add Coolant to the Coolant Surge Tank.”

CAUTION:

You can be burned if you spill coolant on hot engine parts. Coolant contains ethylene glycol, and it will burn if the engine parts are hot enough. Do not spill coolant on a hot engine.

When replacing the pressure cap, make sure it is hand-tight.

Coolant Surge Tank Pressure Cap

Notice: If the pressure cap is not tightly installed, coolant loss and possible engine damage may occur. Be sure the cap is properly and tightly secured.

If you replace your coolant surge tank pressure cap, a Saturn cap is required.

Engine Overheating

You will find a coolant temperature gage and a coolant temperature warning light on your vehicle's instrument panel. See *Engine Coolant Temperature Gage on page 3-33* and *Engine Coolant Temperature Warning Light on page 3-32*. You will also find a low coolant level warning light on your vehicle's instrument panel. See *Low Coolant Warning Light on page 3-33*.

If Steam Is Coming From Your Engine



CAUTION:

Steam from an overheated engine can burn you badly, even if you just open the hood. Stay away from the engine if you see or hear steam coming from it. Just turn it off and get everyone away from the vehicle until it cools down. Wait until there is no sign of steam or coolant before you open the hood.

If you keep driving when your engine is overheated, the liquids in it can catch fire. You or others could be badly burned. Stop your engine if it overheats, and get out of the vehicle until the engine is cool.

Notice: If your engine catches fire because you keep driving with no coolant, your vehicle can be badly damaged. The costly repairs would not be covered by your warranty.

If No Steam Is Coming From Your Engine

An overheat warning, along with a low coolant light, can indicate a serious problem. See *Low Coolant Warning Light* on page 3-33.

If you get an engine overheat warning with no low coolant light, but see or hear no steam, the problem may not be too serious. Sometimes the engine can get a little too hot when you:

- Climb a long hill on a hot day.
- Stop after high-speed driving.
- Idle for long periods in traffic.
- Tow a trailer.

If you get the overheat warning with no sign of steam, try this for a minute or so:

1. If you have an air conditioner and it's on, turn it off.
2. Turn on your heater to full hot at the highest fan speed and open the window as necessary.
3. Try to minimize engine load. If you're in a traffic jam, shift to NEUTRAL (N); otherwise, shift to the highest gear while driving.

If you no longer have the overheat warning, you can drive. Just to be safe, drive slower for about ten minutes. If the warning doesn't come back on, you can drive normally.

If the warning continues and you have not stopped, pull over, stop, and park your vehicle right away.

If there is still no sign of steam, you can idle the engine for three minutes while you're parked. If you still have the warning, *turn off the engine and get everyone out of the vehicle* until it cools down.

You may decide not to lift the hood but to get service help right away.

Cooling System

When you decide it is safe to lift the hood, here is what you will see:



- A. Coolant Surge Tank with Pressure Cap
- B. Electric Engine Fan

CAUTION:

An electric engine cooling fan under the hood can start up even when the engine is not running and can injure you. Keep hands, clothing and tools away from any underhood electric fan.

If the coolant inside the coolant surge tank is boiling, do not do anything else until it cools down. The vehicle should be parked on a level surface.



The coolant level should be at the COLD line (surge tank seam). If it is not, you may have a leak at the radiator hoses, heater hoses, radiator, water pump or somewhere else in the cooling system.

CAUTION:

Heater and radiator hoses, and other engine parts, can be very hot. Do not touch them. If you do, you can be burned.

Do not run the engine if there is a leak. If you run the engine, it could lose all coolant. That could cause an engine fire, and you could be burned. Get any leak fixed before you drive the vehicle.

If there seems to be no leak, with the engine on, check to see if the electric engine cooling fans are running. If the engine is overheating, both fans should be running. If they are not, your vehicle needs service. Turn off the engine.

Notice: Engine damage from running your engine without coolant is not covered by your warranty.

Notice: Using coolant other than DEX-COOL[®] may cause premature engine, heater core or radiator corrosion. In addition, the engine coolant may require changing sooner, at 30,000 miles (50 000 km) or 24 months, whichever occurs first. Any repairs would not be covered by your warranty. Always use DEX-COOL[®] (silicate-free) coolant in your vehicle.

How to Add Coolant to the Coolant Surge Tank

Notice: This vehicle has a specific coolant fill procedure. Failure to follow this procedure could cause your engine to overheat and be severely damaged.

If you have not found a problem yet, check to see if coolant is visible in the surge tank. If coolant is visible but the coolant level isn't at the FULL COLD mark, add a 50/50 mixture of *clean, drinkable water* and DEX-COOL[®] coolant at the coolant surge tank, but be sure the cooling system, including the coolant surge tank pressure cap, is cool before you do it. See *Engine Coolant* on page 5-23 for more information.

CAUTION:

Steam and scalding liquids from a hot cooling system can blow out and burn you badly. They are under pressure, and if you turn the coolant surge tank pressure cap — even a little — they can come out at high speed.

CAUTION: (Continued)

CAUTION: (Continued)

Never turn the cap when the cooling system, including the coolant surge tank pressure cap, is hot. Wait for the cooling system and coolant surge tank pressure cap to cool if you ever have to turn the pressure cap.



⚠ CAUTION:

Adding only plain water to your cooling system can be dangerous. Plain water, or some other liquid such as alcohol, can boil before the proper coolant mixture will. Your vehicle's coolant warning system is set for the proper coolant mixture. With plain water or the wrong mixture, your engine could get too hot but you would not get the overheat warning. Your engine could catch fire and you or others could be burned. Use a 50/50 mixture of clean, drinkable water and DEX-COOL[®] coolant.

Notice: In cold weather, water can freeze and crack the engine, radiator, heater core and other parts. Use the recommended coolant and the proper coolant mixture.

⚠ CAUTION:

You can be burned if you spill coolant on hot engine parts. Coolant contains ethylene glycol and it will burn if the engine parts are hot enough. Do not spill coolant on a hot engine.



1. You can remove the coolant surge tank pressure cap when the cooling system, including the coolant surge tank pressure cap and upper radiator hose, is no longer hot. Turn the pressure cap slowly counterclockwise (left) about one-quarter of a turn. If you hear a hiss, wait for that to stop. This will allow any pressure still left to be vented out the discharge hose.
2. Then keep turning the pressure cap slowly, and remove it.



3. Fill the coolant surge tank with the proper DEX-COOL[®] coolant mixture, to the COLD line.



4. With the coolant surge tank pressure cap off, start the engine and let it run until you can feel the upper radiator hose getting hot. Watch out for the engine cooling fans.
By this time, the coolant level inside the coolant surge tank may be lower. If the level is lower, add more of the proper DEX-COOL[®] coolant mixture to the coolant surge tank until the level reaches the COLD line.
5. Then replace the pressure cap. Be sure the pressure cap is hand-tight.

Check the level in the surge tank when the cooling system has cooled down. If the coolant is not at the proper level, repeat Steps 1 through 3 and reinstall the pressure cap. If the coolant isn't at the proper level when the system cools down again, see your retailer.

Power Steering Fluid

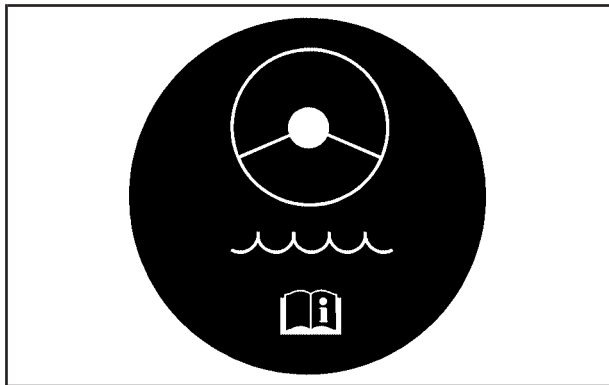

The power steering fluid reservoir is located toward the front of the engine compartment on the driver's side of the vehicle. See *Engine Compartment Overview on page 5-12* for more information on location.

When to Check Power Steering Fluid

It is not necessary to regularly check power steering fluid unless you suspect there is a leak in the system or you hear an unusual noise. A fluid loss in this system could indicate a problem. Have the system inspected and repaired. See *Engine Compartment Overview on page 5-12* for reservoir location.

How to Check Power Steering Fluid

Turn the key off, let the engine compartment cool down, wipe the cap and the top of the reservoir clean, then unscrew the cap and wipe the dipstick with a clean rag. Replace the cap and completely tighten it. Then remove the cap again and look at the fluid level on the dipstick.

The level should be at the "C" mark. If necessary, add only enough fluid to bring the level up to the mark.

What to Use

To determine what kind of fluid to use, see *Recommended Fluids and Lubricants on page 6-12*. Always use the proper fluid. Failure to use the proper fluid can cause leaks and damage hoses and seals.

Windshield Washer Fluid

What to Use

When you need windshield or rear window (wagon models) washer fluid be sure to read the instructions before use. If you will be operating your vehicle in an area where the temperature may fall below freezing, use a fluid that has sufficient protection against freezing.

Adding Windshield Washer Fluid

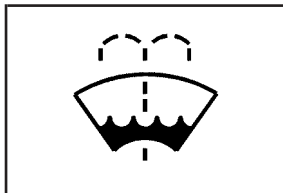

Open the cap with the washer fluid symbol printed on it and add washer fluid until the tank is full.

Notice:

- When using concentrated washer fluid, follow the manufacturer's instructions for adding water.
- Do not mix water with ready-to-use washer fluid. Water can cause the solution to freeze and damage your washer fluid tank and other parts of the washer system. Also, water does not clean as well as washer fluid.
- Fill your washer fluid tank only three-quarters full when it is very cold. This allows for expansion if freezing occurs, which could damage the tank if it is completely full.
- Do not use engine coolant (antifreeze) in your windshield washer. It can damage your washer system and paint.

Brakes

Brake Fluid



Your brake master cylinder reservoir is filled with DOT-3 brake fluid. See *Engine Compartment Overview* on page 5-12 for the location of the reservoir.

There are only two reasons why the brake fluid level in the reservoir might go down. The first is that the brake fluid goes down to an acceptable level during normal brake lining wear. When new linings are put in, the fluid level goes back up. The other reason is that fluid is leaking out of the brake system. If it is, you should have your brake system fixed, since a leak means that sooner or later your brakes will not work well, or will not work at all.

So, it is not a good idea to “top off” your brake fluid. Adding brake fluid will not correct a leak. If you add fluid when your linings are worn, then you will have too much fluid when you get new brake linings. You should add (or remove) brake fluid, as necessary, only when work is done on the brake hydraulic system.

CAUTION:

If you have too much brake fluid, it can spill on the engine. The fluid will burn if the engine is hot enough. You or others could be burned, and your vehicle could be damaged. Add brake fluid only when work is done on the brake hydraulic system.

When your brake fluid falls to a low level, your brake warning light will come on. See *Brake System Warning Light* on page 3-30.

What to Add

When you do need brake fluid, use only DOT-3 brake fluid. Use new brake fluid from a sealed container only. See *Recommended Fluids and Lubricants* on page 6-12.

Always clean the brake fluid reservoir cap and the area around the cap before removing it. This will help keep dirt from entering the reservoir.

CAUTION:

With the wrong kind of fluid in your brake system, your brakes may not work well, or they may not even work at all. This could cause a crash. Always use the proper brake fluid.

Notice:

- **Using the wrong fluid can badly damage brake system parts. For example, just a few drops of mineral-based oil, such as engine oil, in your brake system can damage brake system parts so badly that they will have to be replaced. Do not let someone put in the wrong kind of fluid.**
- **If you spill brake fluid on your vehicle's painted surfaces, the paint finish can be damaged. Be careful not to spill brake fluid on your vehicle. If you do, wash it off immediately. See *Appearance Care* on page 5-82.**

Brake Wear

Your vehicle has four-wheel disc brakes.

Disc brake pads have built-in wear indicators that make a high-pitched warning sound when the brake pads are worn and new pads are needed. The sound may come and go or be heard all the time your vehicle is moving (except when you are pushing on the brake pedal firmly).

CAUTION:

The brake wear warning sound means that soon your brakes will not work well. That could lead to an accident. When you hear the brake wear warning sound, have your vehicle serviced.

Notice: Continuing to drive with worn-out brake pads could result in costly brake repair.

Some driving conditions or climates may cause a brake squeal when the brakes are first applied or lightly applied. This does not mean something is wrong with your brakes.

Properly torqued wheel nuts are necessary to help prevent brake pulsation. When tires are rotated, inspect brake pads for wear and evenly tighten wheel nuts in the proper sequence to Saturn torque specifications.

Brake linings should always be replaced as complete axle sets.

Brake Pedal Travel

See your retailer if the brake pedal does not return to normal height, or if there is a rapid increase in pedal travel. This could be a sign of brake trouble.

Brake Adjustment

Every time you make a moderate brake stop, your brakes adjust for wear. If you rarely make a moderate or heavier stop, then your brakes might not adjust correctly. If you drive in that way, then — very carefully — make a few moderate brake stops about every 1,000 miles (1 600 km), so your brakes will adjust properly.

Replacing Brake System Parts

The braking system on a vehicle is complex. Its many parts have to be of top quality and work well together if the vehicle is to have really good braking. Your vehicle was designed and tested with top-quality brake parts. When you replace parts of your braking system — for example, when your brake linings wear down and you need new ones put in — be sure you get new approved Saturn replacement parts. If you do not, your brakes may no longer work properly. For example, if someone puts in brake linings that are wrong for your vehicle, the balance between your front and rear brakes can change — for the worse. The braking performance you have come to expect can change in many other ways if someone puts in the wrong replacement brake parts.

Battery

Your new vehicle comes with a maintenance free ACDelco® battery. When it is time for a new battery, get one that has the replacement number shown on the original battery's label. We recommend an ACDelco® battery. See *Engine Compartment Overview* on page 5-12 for battery location.



Warning: Battery posts, terminals and related accessories contain lead and lead compounds, chemicals known to the State of California to cause cancer and reproductive harm. Wash hands after handling.

Vehicle Storage

If you are not going to drive your vehicle for 25 days or more, remove the black, negative (-) cable from the battery. This will help keep your battery from running down.

CAUTION:

Batteries have acid that can burn you and gas that can explode. You can be badly hurt if you are not careful. See *Jump Starting* on page 5-40 for tips on working around a battery without getting hurt.

Contact your Saturn retailer to learn how to prepare your vehicle for longer storage periods.

Also, for your audio system, see *Theft-Deterrent Feature* on page 3-69.

Jump Starting

If your battery has run down, you may want to use another vehicle and some jumper cables to start your vehicle. Be sure to follow the steps below to do it safely.

CAUTION:

Batteries can hurt you. They can be dangerous because:

- They contain acid that can burn you.
- They contain gas that can explode or ignite.
- They contain enough electricity to burn you.

If you do not follow these steps exactly, some or all of these things can hurt you.

Notice: Ignoring these steps could result in costly damage to your vehicle that would not be covered by your warranty.

Trying to start your vehicle by pushing or pulling it will not work, and it could damage your vehicle.

1. Check the other vehicle. It must have a 12-volt battery with a negative ground system.

Notice: If the other vehicle's system is not a 12-volt system with a negative ground, both vehicles can be damaged. Only use vehicles with 12-volt systems with negative grounds to jump start your vehicle.

2. Get the vehicles close enough so the jumper cables can reach, but be sure the vehicles are not touching each other. If they are, it could cause a ground connection you do not want. You would not be able to start your vehicle, and the bad grounding could damage the electrical systems.

To avoid the possibility of the vehicles rolling, set the parking brake firmly on both vehicles involved in the jump start procedure. Put an automatic transaxle in PARK (P) or a manual transaxle in NEUTRAL before setting the parking brake.

Notice: If you leave your radio or other accessories on during the jump starting procedure, they could be damaged. The repairs would not be covered by your warranty. Always turn off your radio and other accessories when jump starting your vehicle.

3. Turn off the ignition on both vehicles. Unplug unnecessary accessories plugged into the cigarette lighter or in the accessory power outlet. Turn off the radio and all lamps that aren't needed. This will avoid sparks and help save both batteries. And it could save your radio!

4. Open the hoods and locate the batteries. Find the positive (+) and negative (-) terminal locations on each vehicle. See *Engine Compartment Overview* on page 5-12 for more information on location.

 **CAUTION:**

An electric fan can start up even when the engine is not running and can injure you. Keep hands, clothing and tools away from any underhood electric fan.

 **CAUTION:**

Using a match near a battery can cause battery gas to explode. People have been hurt doing this, and some have been blinded. Use a flashlight if you need more light.

Be sure the battery has enough water. You do not need to add water to the ACDelco® battery installed in your new vehicle. But if a battery has filler caps, be sure the right amount of fluid is there. If it is low, add water to take care of that first. If you do not, explosive gas could be present.

Battery fluid contains acid that can burn you. Do not get it on you. If you accidentally get it in your eyes or on your skin, flush the place with water and get medical help immediately.

⚠ CAUTION:

Fans or other moving engine parts can injure you badly. Keep your hands away from moving parts once the engine is running.

5. Check that the jumper cables do not have loose or missing insulation. If they do, you could get a shock. The vehicles could be damaged, too.

Before you connect the cables, here are some basic things you should know. Positive (+) will go to positive (+) or to a remote positive (+) terminal if the vehicle has one. Negative (-) will go to a heavy, unpainted metal engine part or to a remote negative (-) terminal if the vehicle has one.

Do not connect positive (+) to negative (-) or you will get a short that would damage the battery and maybe other parts, too. And do not connect the negative (-) cable to the negative (-) terminal on the dead battery because this can cause sparks.



6. Remove the terminal cover and connect the red positive (+) cable to the positive (+) terminal of the dead battery. Use a remote positive (+) terminal if the vehicle has one. The positive (+) terminal on your vehicle is covered by a red protector cap which must be removed before you connect the positive (+) jumper cable to the positive (+) terminal of the dead battery.



7. Do not let the other end touch metal. Connect it to the positive (+) terminal of the good battery. Use a remote positive (+) terminal if the vehicle has one.



8. Now connect the black negative (-) cable to the negative (-) terminal of the good battery. Use a remote negative (-) terminal if the vehicle has one.

Do not let the other end touch anything until the next step. The other end of the negative (-) cable *doesn't* go to the dead battery. It goes to a heavy, unpainted metal part or to a remote negative (-) terminal on the vehicle with the dead battery.



9. Connect the other end of the negative (-) cable at least 18 inches (45 cm) away from the dead battery, but not near engine parts that move. The electrical connection is just as good there, and the chance of sparks getting back to the battery is much less.

10. Now start the vehicle with the good battery and run the engine for a while.
11. Press UNLOCK on the RKE transmitter to disarm your security system (if equipped).
12. Try to start the vehicle that had the dead battery. If it won't start after a few tries, it probably needs service.

Notice: If the jumper cables are removed in the wrong order, electrical shorting may occur and damage the vehicle. The repairs would not be covered by your warranty. Remove the jumper cables in the correct order, making sure that the cables do not touch each other or other metal.

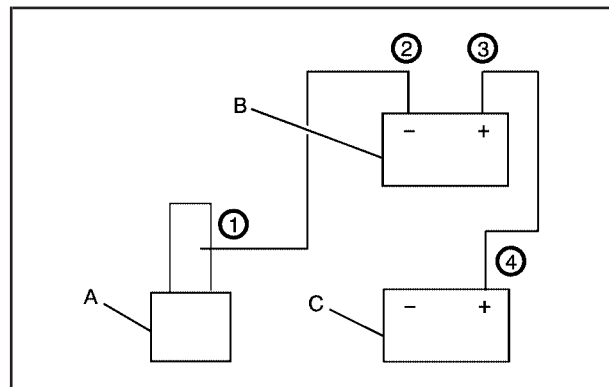

Jumper Cable Removal

- A. Heavy, Unpainted Metal Engine Part
- B. Good Battery
- C. Dead Battery

To disconnect the jumper cables from both vehicles, do the following:

1. Disconnect the black negative (-) cable from the vehicle that had the dead battery.
2. Disconnect the black negative (-) cable from the vehicle with the good battery.
3. Disconnect the red positive (+) cable from the vehicle with the good battery.
4. Disconnect the red positive (+) cable from the other vehicle.
5. Return the terminal cover to its original position.

Bulb Replacement

For the type of bulb to use, see *Replacement Bulbs* on page 5-52.

For any bulb changing procedure not listed in this section, contact your retailer.

Halogen Bulbs

CAUTION:

Halogen bulbs have pressurized gas inside and can burst if you drop or scratch the bulb. You or others could be injured. Be sure to read and follow the instructions on the bulb package.

Headlamps, Front Turn Signal, Sidermarker, and Parking Lamps

1. Open the hood and secure it with the prop rod.



2. Remove push-pin fasteners from grill assembly.
3. Tilt grill assembly forward and lift it up to remove it from the body of the vehicle.



4. Remove fasteners from headlamp assembly.



5. Push headlamp housing lever up to disengage headlamp housing from headlamp housing pocket.
6. Turn the bulb socket being replaced counterclockwise one-quarter of a turn while pressing the socket in firmly. Pull the socket rearward until the bulb clears the headlamp housing, and lift it up to access the bulb.
7. Disconnect the wire connector from the bulb by lifting the lock tab and pulling it away from the plastic base.
8. Remove the bulb assembly and replace it with the appropriate bulb.

Fog Lamps



1. Reach up from underneath the front body panel and turn the bulb socket counterclockwise one-quarter of a turn while pressing the socket in firmly. Pull the socket rearward until the bulb clears the fog lamp housing.
2. Disconnect the wire connector from the bulb by lifting the lock tab and pulling it away from the plastic base.
3. Remove the bulb assembly and replace it with the appropriate bulb.

Center High-Mounted Stoplamp (CHMSL) (Sedan)

1. Remove the center high mounted stop lamp cover by pulling down on the cover edges.
2. Turn the bulb socket being replaced counterclockwise one-quarter of a turn and remove the bulb.
3. Replace it with the appropriate bulb.

Center High-Mounted Stoplamp (CHMSL) (Wagon)



1. Open the liftgate.
2. Remove the center high mounted stop lamp cover by pulling down on the cover edges.
3. Turn the bulb socket being replaced counterclockwise one-quarter of a turn and remove the bulb.
4. Replace it with the appropriate bulb.

Taillamps, Turn Signal, Stoplamps and Back-up Lamps (Sedan)



1. Open the trunk.
2. Pull back with interior trim.



3. Remove fasteners from backside of taillamp housing.



4. Remove taillamp housing from body of vehicle.
5. Turn the bulb socket being replaced counterclockwise one-quarter of a turn while pressing the socket in firmly. Pull the socket rearward until the bulb clears the taillamp housing.
6. Replace it with the appropriate bulb.

Taillamps, Turn Signal, Stoplamps and Back-up Lamps (Wagon)



1. Open the liftgate.
2. Remove the interior access trim panel.
3. Turn the bulb socket being replaced counterclockwise one-quarter of a turn while pressing the socket in firmly. Pull the socket rearward until the bulb clears the taillamp housing.
4. Replace it with the appropriate bulb.

Replacement Bulbs

Exterior Lamp	Bulb Number
Headlamps	—
High Beam	9005 HB39441732
Low Beam	9006 HB49441733
Front Park/Turn Lamps	34571999381
Front Side Markert Lamps	W5W12092811
Stop/Taillamps	P21/5W21019520
Rear Turn Lamps	P21W21019521
Back-up Lamps	P21W21019520
CHMSL	PC16825085970
Fog Lamps	880L12450143

Windshield Wiper Blade Replacement

Windshield wiper blades should be inspected at least twice a year for wear or cracking. See "Windshield Wipers, Blade Check" under *Scheduled Maintenance on page 6-4* for more information.

Replacement blades come in different types and are removed in different ways. For proper type and length, see *Normal Maintenance Replacement Parts on page 6-13*. Here's how to remove the wiper blades:

1. Turn on the wipers to the low wipe setting.
2. Turn off the ignition while the wipers are at the outer positions of the wiper pattern. The blades are more accessible for removal/replacement while in this position.
3. Pull the windshield wiper arm away from the windshield.

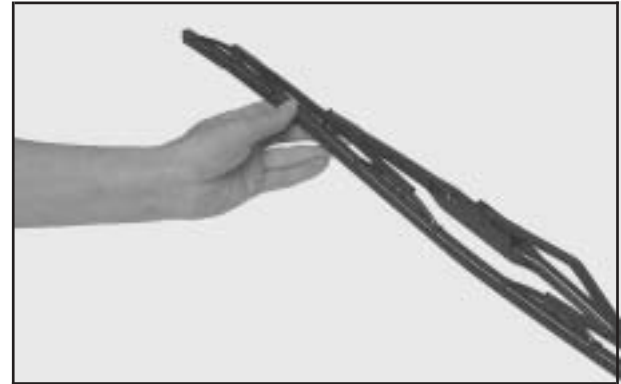

4. While holding the wiper arm away from the glass, push the release clip from under the blade connecting point and pull the old blade assembly down toward the glass to remove it from the wiper arm.
5. Push the new wiper blade securely on the wiper arm until you hear the release clip "click" into place.

Tires

Your new vehicle comes with high-quality tires made by a leading tire manufacturer. If you ever have questions about your tire warranty and where to obtain service, see your GM Warranty booklet for details. For additional information refer to the tire manufacturer's booklet included with your vehicle's Owner's Manual.

CAUTION:

Poorly maintained and improperly used tires are dangerous.

- **Overloading your tires can cause overheating as a result of too much friction. You could have an air-out and a serious accident. See "Loading Your Vehicle" in the Index.**

CAUTION: (Continued)

CAUTION: (Continued)

- **Underinflated tires pose the same danger as overloaded tires. The resulting accident could cause serious injury. Check all tires frequently to maintain the recommended pressure. Tire pressure should be checked when your tires are cold.**
- **Overinflated tires are more likely to be cut, punctured or broken by a sudden impact — such as when you hit a pothole. Keep tires at the recommended pressure.**
- **Worn, old tires can cause accidents. If your tread is badly worn, or if your tires have been damaged, replace them.**

Tire Sidewall Labeling

Useful information about a tire is molded into its sidewall. The examples below show a typical passenger car tire and a compact spare tire sidewall.

(E) Tire Ply Material: The type of cord and number of plies in the sidewall and under the tread.

(F) Uniform Tire Quality Grading (UTQG): Tire manufacturers are required to grade tires based on three performance factors: treadwear, traction and temperature resistance. For more information see *Uniform Tire Quality Grading* on page 5-65.

(G) Maximum Cold Inflation Load Limit: Maximum load that can be carried and the maximum pressure needed to support that load. For more information on recommended tire pressure see *Inflation - Tire Pressure* on page 5-61 and *Loading Your Vehicle* on page 4-34.

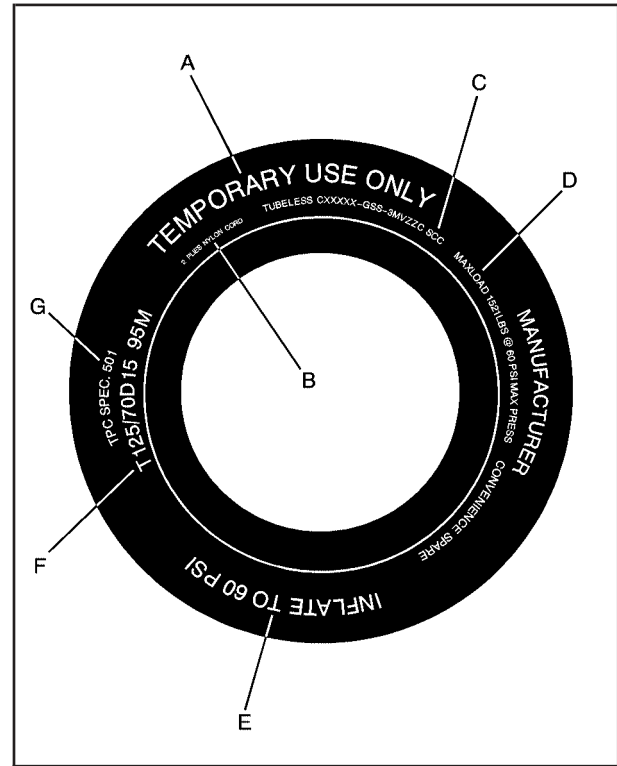

Compact Spare Tire Example

(A) Temporary Use Only: The compact spare tire or temporary use tire has a tread life of approximately 3,000 miles (5 000 km) and should not be driven at speeds over 65 mph (105 km/h). The compact spare tire is for emergency use when a regular road tire has lost air and gone flat. See *Compact Spare Tire on page 5-81* and *If a Tire Goes Flat on page 5-69*.

(B) Tire Ply Material: The type of cord and number of plies in the sidewall and under the tread.

(C) Tire Identification Number (TIN): The Tire Identification Number (TIN). The TIN shows the manufacturer and plant code, tire size, and date the tire was manufactured. The TIN is molded onto both sides of the tire, although only one side may have the date of manufacture.

(D) Maximum Cold Inflation Load Limit: Maximum load that can be carried and the maximum pressure needed to support that load. See *Compact Spare Tire on page 5-81* and *Loading Your Vehicle on page 4-34*.

(E) Tire Inflation: The temporary use tire or compact spare tire should be inflated to 60 psi (420 kPa). For more information on tire pressure and inflation see *Inflation - Tire Pressure on page 5-61*.

(F) Tire Size: A combination of letters and numbers define a tire's width, height, aspect ratio, construction type and service description. The letter "T" as the first character in the tire size means the tire is for temporary use only.

(G) Tire Performance Criteria Specification (TPC Spec): Original equipment tires designed to GM's specific tire performance criteria have a TPC specification code molded onto the sidewall. GM's TPC specifications meet or exceed all federal safety guidelines.

Tire Size

The following illustration shows an example of a typical passenger car tire size.

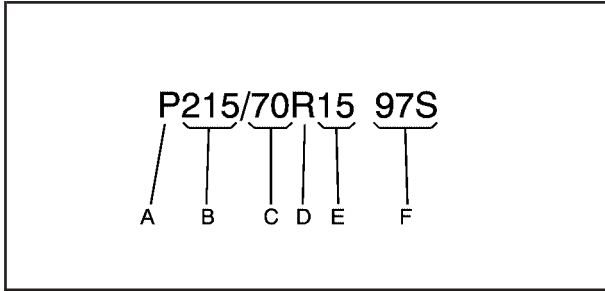

(A) P-Metric Tire: The United States version of a metric tire sizing system. The letter "P" as the first character in the tire size means a passenger vehicle tire engineered to standards set by the U. S. Tire and Rim Association.

(B) Tire Width: The three-digit number indicates the tire section width in millimeters from sidewall to sidewall.

(C) Aspect Ratio: A two-digit number that indicates the tire height-to-width measurements. For example, if the tire size aspect ratio is "70," as shown in item "C" of the illustration, it would mean that the tire's sidewall is 70% as high as it is wide.

(D) Construction Code: A letter code is used to indicate the type of ply construction in the tire. The letter "R" means radial ply construction; the letter "D" means diagonal or bias ply construction; and the letter "B" means belted-bias ply construction.

(E) Rim Diameter: Diameter of the wheel in inches.

(F) Service Description: These characters represent the load range and the speed rating of a tire. The load range represents the load carrying capacity a tire is certified to carry. The load index can range from 1 to 279. The speed rating is the maximum speed a tire is certified to carry a load. Speed ratings range from "A" to "Z".

Tire Terminology and Definitions

Air Pressure: The amount of air inside the tire pressing outward on each square inch of the tire. Air pressure is expressed in pounds per square inch (psi) or kilopascal (kPa).

Accessory Weight: This means the combined weight of optional accessories. Some examples of optional accessories are, automatic transmission, power steering, power brakes, power windows, power seats, and air conditioning.

Aspect Ratio: The relationship of a tire's height to its width.

Belt: A rubber coated layer of cords that is located between the plies and the tread. Cords may be made from steel or other reinforcing materials.

Bead: The tire bead contains steel wires wrapped by steel cords that hold the tire onto the rim.

Bias Ply Tire: A pneumatic tire in which the plies are laid at alternate angles less than 90 degrees to the centerline of the tread.

Cold Inflation Pressure: The amount of air pressure in a tire, measured in pounds per square inch (psi) before a tire has built up heat from driving. See *Inflation - Tire Pressure on page 5-61*.

Curb Weight: This means the weight of a motor vehicle with standard and optional equipment including the maximum capacity of fuel, oil and coolant, but without passengers and cargo.

DOT Markings: A code molded into the sidewall of a tire signifying that the tire is in compliance with the U.S. Department of Transportation motor vehicle safety standards. The DOT code includes the Tire Identification Number (TIN), an alphanumeric designator which can also identify the tire manufacturer, production plant, brand and date of production.

GVWR: Gross Vehicle Weight Rating, see *Loading Your Vehicle on page 4-34*.

GAWR FRT: Gross Axle Weight Rating for the front axle, see *Loading Your Vehicle on page 4-34*.

GAWR RR: Gross Axle Weight Rating for the rear axle, see *Loading Your Vehicle on page 4-34*.

Intended Outboard Sidewall: The side of an asymmetrical tire that must always face outward when mounted on a vehicle.

Kilopascal (kPa): The metric unit for air pressure. There are 6.9 kPa's to one psi.

Light Truck (LT-Metric) Tire: A tire used on light duty trucks and some multipurpose passenger vehicles.

Load Index: An assigned number ranging from 1 to 279 that corresponds to the load carrying capacity of a tire.

Maximum Inflation Pressure: The maximum air pressure to which a cold tire may be inflated. The maximum air pressure is molded onto the sidewall.

Maximum Load Rating: The load rating for a tire at the maximum permissible inflation pressure for that tire.

Maximum Loaded Vehicle Weight: The sum of curb weight; accessory weight; vehicle capacity weight; and production options weight.

Normal Occupant Weight: The number of occupants a vehicle is designed to seat multiplied by 150 pounds (68 kg). See *Loading Your Vehicle on page 4-34*.

Occupant Distribution: Designated seating positions.

Outward Facing Sidewall: The side of a asymmetrical tire that has a particular side that faces outward when mounted on a vehicle. The side of the tire that contains a whitewall, bears white lettering or bears manufacturer, brand and or model name molding that is higher or deeper than the same moldings on the other sidewall of the tire.

Passenger (P-Metric) Tire: A tire used on passenger cars and some light duty trucks and multipurpose vehicles.

Recommended Inflation Pressure: Vehicle manufacturer's recommended tire inflation pressure and shown on the tire placard. See *Inflation - Tire Pressure on page 5-61* and *Loading Your Vehicle on page 4-34*.

Radial Ply tire: A pneumatic tire in which the ply cords that extend to the beads are laid at 90 degrees to the centerline of the tread.

Rim: A metal support for a tire and upon which the tire beads are seated.

Sidewall: The portion of a tire between the tread and the bead.

Speed Rating: An alphanumeric code assigned to a tire indicating the maximum speed at which a tire can operate.

Traction: The friction between the tire and the road surface. The amount of grip provided.

Tread: The portion of a tire that comes into contact with the road.

Treadwear Indicators: Narrow bands, sometimes called "wear bars," that show across the tread of a tire when only 2/32 inch of tread remains. See *When It Is Time for New Tires on page 5-64*.

UTQGS: Uniform Tire Quality Grading Standards, a tire information system that provides consumers with ratings for a tire's traction, temperature and treadwear. Ratings are determined by tire manufacturers using government testing procedures. The ratings are molded into the sidewall of the tire. See *Uniform Tire Quality Grading on page 5-65*.

Vehicle Capacity Weight: The number of designated seating positions multiplied by 150 lbs. (68 kg) plus the rated cargo load. See *Loading Your Vehicle on page 4-34*.

Vehicle Maximum Load on the Tire: Load on an individual tire due to curb weight, accessory weight, occupant weight and cargo weight.

Vehicle Placard: A label permanently attached to a vehicle showing the original equipment tire size and recommended inflation pressure. See *Loading Your Vehicle on page 4-34*.

Inflation - Tire Pressure

The tire and loading information label, shows the correct inflation pressures for your tires when they're cold. "Cold" means your vehicle has been sitting for at least three hours or driven no more than 1 mile (1.6 km). See *Loading Your Vehicle on page 4-34*, for the location of your vehicle's tire and loading information label.

Notice: Don't let anyone tell you that underinflation or overinflation is all right. It's not. If your tires don't have enough air (underinflation), you can get the following:

- Too much flexing
- Too much heat
- Tire overloading
- Bad wear
- Bad handling
- Bad fuel economy

If your tires have too much air (overinflation), you can get the following:

- Unusual wear
- Bad handling
- Rough ride
- Needless damage from road hazards

When to Check

Check your tires once a month or more.

Don't forget your compact spare tire. It should be at 60 psi (420 kPa).

How to Check

Use a good quality pocket-type gage to check tire pressure. You can't tell if your tires are properly inflated simply by looking at them. Radial tires may look properly inflated even when they're underinflated. Check the tire's inflation pressure when the tires are cold. Cold means your vehicle has been sitting for at least three hours or driven no more than 1 mile (1.6 km).

Remove the valve cap from the tire valve stem. Press the tire gage firmly onto the valve to get a pressure measurement. If the cold tire inflation pressure matches the recommended pressure on the Tire and Loading Information label, no further adjustment is necessary. If the inflation pressure is low, add air until you reach the recommended amount.

If you overfill the tire, release air by pushing on the metal stem in the center of the tire valve. Recheck the tire pressure with the tire gage.

Be sure to put the valve caps back on the valve stems. They help prevent leaks by keeping out dirt and moisture.

Tire Inspection and Rotation

Tires should be rotated every 5,000 to 8,000 miles (8 000 to 13 000 km).

Any time you notice unusual wear, rotate your tires as soon as possible and check wheel alignment. Also check for damaged tires or wheels. See *When It Is Time for New Tires on page 5-64* and *Wheel Replacement on page 5-67* for more information.

The purpose of regular rotation is to achieve more uniform wear for all tires on the vehicle. The first rotation is the most important. See *Scheduled Maintenance on page 6-4* for scheduled rotation intervals.

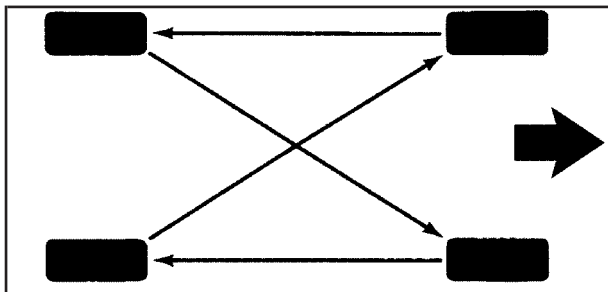

When rotating your tires, always use the correct rotation pattern shown here.

Don't include the compact spare tire in your tire rotation.

If you are towing your Saturn vehicle with all four wheels on the ground, the transaxle and tire maintenance should be scheduled by mileage accumulated through both driving and towing, not to driven (odometer) mileage. Tire wear will reflect actual "rolling" mileage and may be greater than expected for the current odometer mileage.

After the tires have been rotated, adjust the front and rear inflation pressures as shown on the Tire-Loading Information label. Make certain that all wheel bolts are properly tightened. See "Wheel Bolt Torque" under *Capacities and Specifications on page 5-98*.

CAUTION:

Rust or dirt on a wheel, or on the parts to which it is fastened, can make wheel bolts become loose after a time. The wheel could come off and cause an accident. When you change a wheel, remove any rust or dirt from places where the wheel attaches to the vehicle. In an emergency, you can use a cloth or a paper towel to do this; but be sure to use a scraper or wire brush later, if you need to, to get all the rust or dirt off. See "Changing a Flat Tire" in the Index.

When It Is Time for New Tires

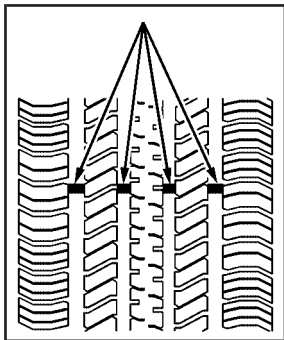

One way to tell when it's time for new tires is to check the treadwear indicators, which will appear when your tires have only 1/16 inch (1.6 mm) or less of tread remaining.

You need a new tire if any of the following statements are true:

- You can see the indicators at three or more places around the tire.
- You can see cord or fabric showing through the tire's rubber.
- The tread or sidewall is cracked, cut or snagged deep enough to show cord or fabric.

- The tire has a bump, bulge or split.
- The tire has a puncture, cut or other damage that can't be repaired well because of the size or location of the damage.

Buying New Tires

To find out what kind and size of tires your vehicle needs, look at the tire and loading information label. For more information about this label and its location on your vehicle, see *Loading Your Vehicle on page 4-34*.

The tires installed on your vehicle when it was new had a Tire Performance Criteria Specification (TPC Spec) number on each tire's sidewall. When you get new tires, GM recommends that you get tires with that same TPC Spec number. That way your vehicle will continue to have tires that are designed to give proper endurance, handling, speed rating, load range, traction, ride and other things during normal service on your vehicle. If your tires have an all-season tread design, the TPC number will be followed by an "MS" (for mud and snow).

If you ever replace your tires with those not having a TPC Spec number, make sure they are the same size, load range, speed rating and construction type (bias, bias-belted or radial) as your original tires.

 **CAUTION:**

Mixing tires could cause you to lose control while driving. If you mix tires of different sizes or types (radial and bias-belted tires), the vehicle may not handle properly, and you could have a crash. Using tires of different sizes may also cause damage to your vehicle. Be sure to use the same size and type tires on all wheels. It's all right to drive with your compact spare temporarily, it was developed for use on your vehicle. See "Compact Spare Tire" in the index.

 **CAUTION:**

If you use bias-ply tires on your vehicle, the wheel rim flanges could develop cracks after many miles of driving. A tire and/or wheel could fail suddenly, causing a crash. Use only radial-ply tires with the wheels on your vehicle.

Uniform Tire Quality Grading

Quality grades can be found where applicable on the tire sidewall between tread shoulder and maximum section width. For example:

Treadwear 200 Traction AA Temperature A

The following information relates to the system developed by the United States National Highway Traffic Safety Administration, which grades tires by treadwear, traction and temperature performance. (This applies only to vehicles sold in the United States.) The grades are molded on the sidewalls of most passenger car tires. The Uniform Tire Quality Grading system does not apply to deep tread, winter-type snow tires, space-saver or temporary use spare tires, tires with nominal rim diameters of 10 to 12 inches (25 to 30 cm), or to some limited-production tires.

While the tires available on Saturn passenger cars and light trucks may vary with respect to these grades, they must also conform to federal safety requirements and additional General Motors Tire Performance Criteria (TPC) standards.

Treadwear

The treadwear grade is a comparative rating based on the wear rate of the tire when tested under controlled conditions on a specified government test course. For example, a tire graded 150 would wear one and a half (1.5) times as well on the government course as a tire graded 100. The relative performance of tires depends upon the actual conditions of their use, however, and may depart significantly from the norm due to variations in driving habits, service practices and differences in road characteristics and climate.

Traction – AA, A, B, C

The traction grades, from highest to lowest, are AA, A, B, and C. Those grades represent the tire's ability to stop on wet pavement as measured under controlled conditions on specified government test surfaces of asphalt and concrete. A tire marked C may have poor traction performance. Warning: The traction grade assigned to this tire is based on straight-ahead braking traction tests, and does not include acceleration, cornering, hydroplaning, or peak traction characteristics.

Temperature – A, B, C

The temperature grades are A (the highest), B, and C, representing the tire's resistance to the generation of heat and its ability to dissipate heat when tested under controlled conditions on a specified indoor laboratory test wheel. Sustained high temperature can cause the material of the tire to degenerate and reduce tire life, and excessive temperature can lead to sudden tire failure. The grade C corresponds to a level of performance which all passenger car tires must meet under the Federal Motor Vehicle Safety Standard No. 109. Grades B and A represent higher levels of performance on the laboratory test wheel than the minimum required by law.

Warning: The temperature grade for this tire is established for a tire that is properly inflated and not overloaded. Excessive speed, underinflation, or excessive loading, either separately or in combination, can cause heat buildup and possible tire failure.

Wheel Alignment and Tire Balance

The wheels on your vehicle were aligned and balanced carefully at the factory to give you the longest tire life and best overall performance.

Scheduled wheel alignment and wheel balancing are not needed. However, if you notice unusual tire wear or your vehicle pulling one way or the other, the alignment may need to be reset. If you notice your vehicle vibrating when driving on a smooth road, your wheels may need to be rebalanced.

Wheel Replacement

Replace any wheel that is bent, cracked or badly rusted or corroded. If wheel bolts keep coming loose, the wheel and wheel bolts should be replaced. If the wheel leaks air, replace it (except some aluminum wheels, which can sometimes be repaired). See your Saturn Retailer if any of these conditions exist.

Your retailer will know the kind of wheel or wheel bolt you need.

Each new wheel should have the same load-carrying capacity, diameter, width, offset and be mounted the same way as the one it replaces.

If you need to replace any of your wheels or wheel bolts, replace them only with new Saturn original equipment parts. This way, you will be sure to have the right wheel and wheel bolts for your Saturn.

CAUTION:

Using the wrong replacement wheels or wheel bolts on your vehicle can be dangerous. It could affect the braking and handling of your vehicle, make your tires lose air and make you lose control. You could have a collision in which you or others could be injured. Always use the correct wheel and wheel bolts for replacement.

Notice: The wrong wheel can also cause problems with bearing life, brake cooling, speedometer or odometer calibration, headlamp aim, bumper height, vehicle ground clearance and tire or tire chain clearance to the body and chassis.

See *Changing a Flat Tire* on page 5-70 for more information.

Used Replacement Wheels

CAUTION:

Putting a used wheel on your vehicle is dangerous. You can't know how it's been used or how far it's been driven. It could fail suddenly and cause a crash. If you have to replace a wheel, use a new Saturn original equipment wheel.

Tire Chains

CAUTION:

Don't use tire chains. There's not enough clearance. Tire chains used on a vehicle without the proper amount of clearance can cause damage to the brakes, suspension or other vehicle parts. The area damaged by the tire chains could cause you to lose control of your vehicle and you or others may be injured in a crash.

Use another type of traction device only if its manufacturer recommends it for use on your vehicle and tire size combination and road conditions. Follow that manufacturer's instructions. To help avoid damage to your vehicle, drive slowly, readjust or remove the device if it's contacting your vehicle, and don't spin your wheels. If you do find traction devices that will fit, install them on the front tires.

If a Tire Goes Flat

It's unusual for a tire to "blowout" while you're driving, especially if you maintain your tires properly. If air goes out of a tire, it's much more likely to leak out slowly. But if you should ever have a "blowout," here are a few tips about what to expect and what to do:

If a front tire fails, the flat tire will create a drag that pulls the vehicle toward that side. Take your foot off the accelerator pedal and grip the steering wheel firmly. Steer to maintain lane position, and then gently brake to a stop well out of the traffic lane.

A rear blowout, particularly on a curve, acts much like a skid and may require the same correction you'd use in a skid. In any rear blowout, remove your foot from the accelerator pedal. Get the vehicle under control by steering the way you want the vehicle to go. It may be very bumpy and noisy, but you can still steer. Gently brake to a stop, well off the road if possible.

CAUTION:

Lifting a vehicle and getting under it to do maintenance or repairs is dangerous without the appropriate safety equipment and training. The jack provided with your vehicle is designed only for changing a flat tire. If it is used for anything else, you or others could be badly injured or killed if the vehicle slips off the jack. Use the jack provided with your vehicle only for changing a flat tire.

If a tire goes flat, the next part shows how to use your jacking equipment to change a flat tire safely.

Changing a Flat Tire

If a tire goes flat, avoid further tire and wheel damage by driving slowly to a level place. Turn on your hazard warning flashers.

CAUTION:

Changing a tire can be dangerous. The vehicle can slip off the jack and roll over or fall on you or other people. You and they could be badly injured or even killed. Find a level place to change your tire.

CAUTION: (Continued)

CAUTION: (Continued)

To help prevent the vehicle from moving:

1. Set the parking brake firmly.
2. Put the shift lever in PARK (P).
3. Turn off the engine and do not restart while the vehicle is raised.
4. Do not allow passengers to remain in the vehicle.

To be even more certain the vehicle won't move, you should put blocks at the front and rear of the tire farthest away from the one being changed. That would be the tire, on the other side, at the opposite end of the vehicle.

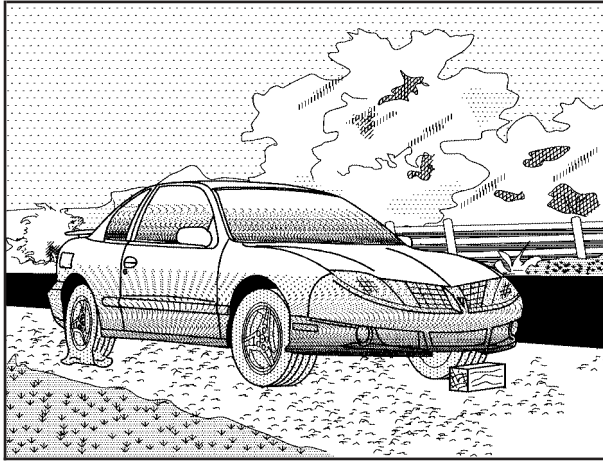

The following steps will tell you how to use the jack and change a tire.

Removing the Spare Tire and Tools (Sedan)

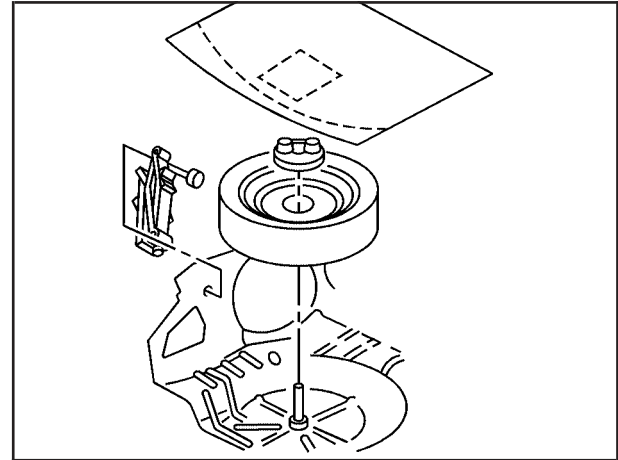

The equipment you'll need is located in the trunk.

1. Open the jack access door on the left side panel of the trunk.
2. Remove the nut that holds the jack in place and remove the jack together with the wheel wrench.

3. Lift the trunk liner and place the plastic hook in the lip of the trunk.
4. Remove the nut that holds down the spare tire.
5. Remove the compact spare tire. See *Compact Spare Tire on page 5-81*
6. The wheel wrench is held in place by two clips which are attached to the jack. Remove the wheel wrench from the jack.
7. Fold out the socket portion of the wrench from the handle.

Removing the Spare Tire and Tools (Wagon)

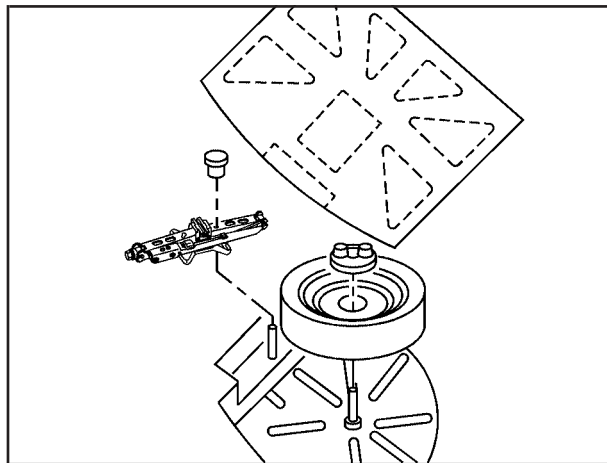

The equipment you'll need is in the cargo area.



1. Lift up the spare tire cover by the handle. Fold the side panels in and then attach the cover to the liftgate with the hook provided.
2. Remove the nut that holds down the spare tire.
3. Remove the compact spare tire. See *Compact Spare Tire* on page 5-81
4. Remove the wing-bolt that holds the jack in place and remove the jack together with the wheel wrench.

5. The wheel wrench is held in place by two clips which are attached to the jack. Remove the wheel wrench from the jack.
6. Fold out the socket portion of the wrench from the handle.

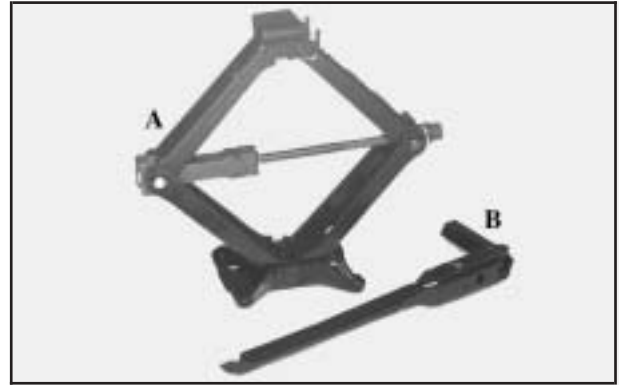

The tools you'll be using include the jack (A) and wheel wrench (B).

Removing the Wheel

You must take off the wheel cover or hubcap to reach the wheel bolts.

For steel wheels with full plastic covers and aluminum wheels with large circular center caps, do the following:

1. Loosen all five hex-shaped plastic caps by turning the wrench counterclockwise. Do not try to remove plastic caps from the cover or center cap.
2. Pull the cover or center cap away from the wheel and place it in the trunk.

When reinstalling full plastic covers or center caps, tighten all five plastic caps hand snug with the aid of the wheel wrench and tighten them with the wheel wrench an additional one-quarter of a turn.

Removing the Flat Tire and Installing the Spare Tire

1. Use the wheel wrench to loosen all the wheel nuts. Don't remove them yet.



2. The jack has a bolt head at the end. Attach the wheel wrench to the jack bolt head and rotate the wheel wrench clockwise (to the right). That will raise the lift head a little.
3. Move the jack over to where the flat tire is.

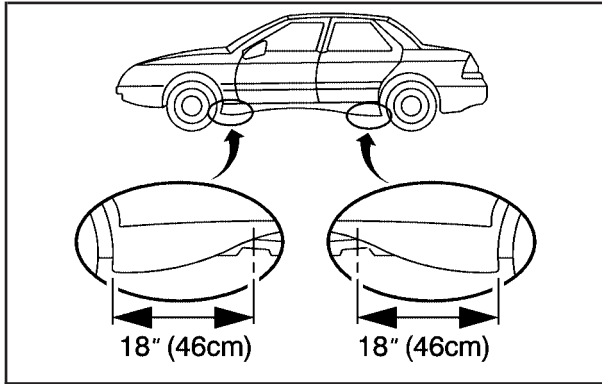

4. Position the lift head at the jack location nearest the flat tire. Your vehicle has jack notches. Position the jack in the notch near the tire being changed, but make sure all of the jack lift head is touching the jacking flange under the body. Do not place the jack under a body panel.

⚠ CAUTION:

Getting under a vehicle when it is jacked up is dangerous. If the vehicle slips off the jack you could be badly injured or killed. Never get under a vehicle when it is supported only by a jack.

⚠ CAUTION:

Raising your vehicle with the jack improperly positioned can damage the vehicle and even make the vehicle fall. To help avoid personal injury and vehicle damage, be sure to fit the jack lift head into the proper location before raising the vehicle.

Notice: Make sure that the jack lift head is in the correct position or you may damage your vehicle. The repairs would not be covered by your warranty.

5. Put the compact spare tire near you.

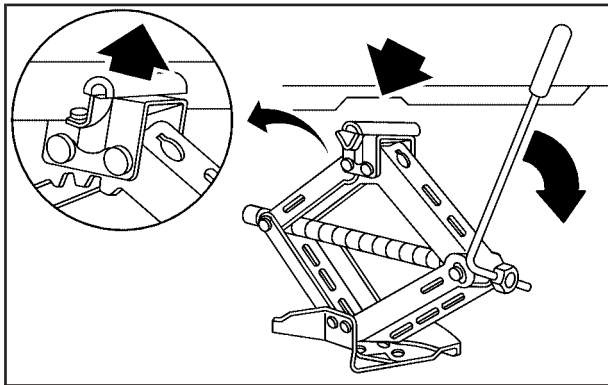

6. Raise the vehicle by turning the jack handle clockwise. Raise the vehicle far enough off the ground so there is enough room for the compact spare tire to fit underneath the wheel well.
7. Remove all of the wheel nuts.
8. Take off the tire and wheel.

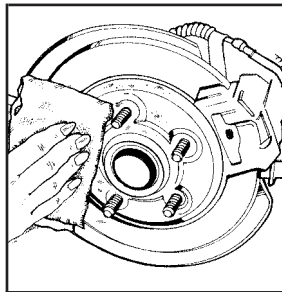

9. Remove any rust or dirt from the wheel bolts, mounting surfaces and spare wheel.

⚠ CAUTION:

Rust or dirt on the wheel, or on the parts to which it is fastened, can make the wheel bolts become loose after a time. The wheel could come off and cause an accident. When you change a wheel, remove any rust or dirt from the places where the wheel attaches to the vehicle. In an emergency, you can use a cloth or a paper towel to do this; but be sure to use a scraper or wire brush later, if you need to, to get all the rust or dirt off.

⚠ CAUTION:

Never use oil or grease on wheel bolts. If you do, the wheel bolts might come loose. Your wheel could fall off, causing a serious accident.

10. Place the compact spare tire on the wheel-mounting surface.
11. Reinstall the wheel nuts. Tighten each nut by hand until the wheel is held against the hub.

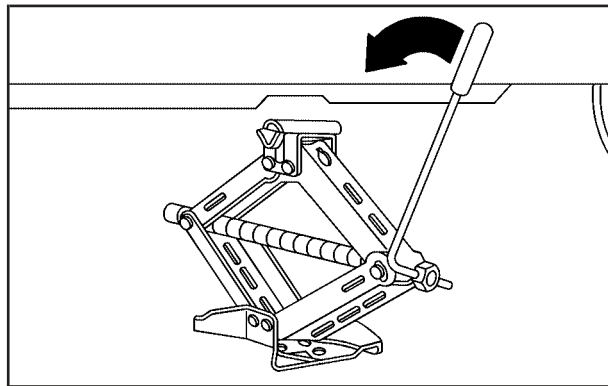

12. Lower the vehicle by turning the jack handle counterclockwise.

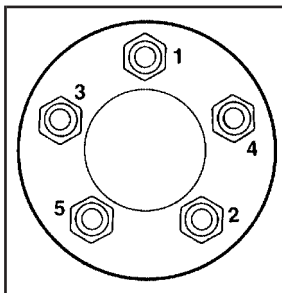

13. Tighten the wheel nuts firmly in a crisscross sequence, as shown.

⚠ CAUTION:

Incorrect wheel bolts or improperly tightened wheel bolts can cause the wheel to come loose and even come off. This could lead to an accident. Be sure to use the correct wheel bolts. If you have to replace them, be sure to get new Saturn original equipment wheel bolts. Stop somewhere as soon as you can and have the bolts tightened with a torque wrench to the proper torque specification. See *Capacities and Specifications on page 5-98* for the wheel bolt torque specification.

Notice: Improperly tightened wheel bolts can lead to brake pulsation and rotor damage. To avoid expensive brake repairs, evenly tighten the wheel bolts in the proper sequence and to the proper torque specification. See *Capacities and Specifications on page 5-98* for the wheel bolt torque specification.

14. Lower the jack all the way and remove the jack from under the vehicle.
15. Tighten the bolts firmly with the wheel wrench.

Do not try to put a wheel cover on your compact spare tire. It will not fit. Store the wheel cover in the trunk until you have the flat tire repaired or replaced.

Notice: Wheel covers will not fit on your compact spare. If you try to put a wheel cover on the compact spare, you could damage the cover or the spare.

Storing a Flat or Spare Tire and Tools

CAUTION:

Storing a jack, a tire, or other equipment in the passenger compartment of the vehicle could cause injury. In a sudden stop or collision, loose equipment could strike someone. Store all these in the proper place.

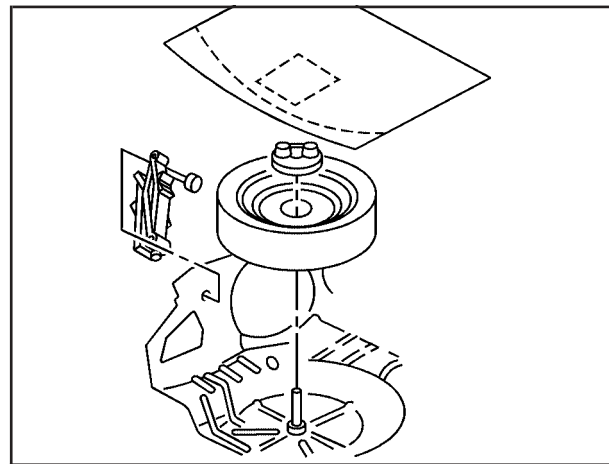

Sedan

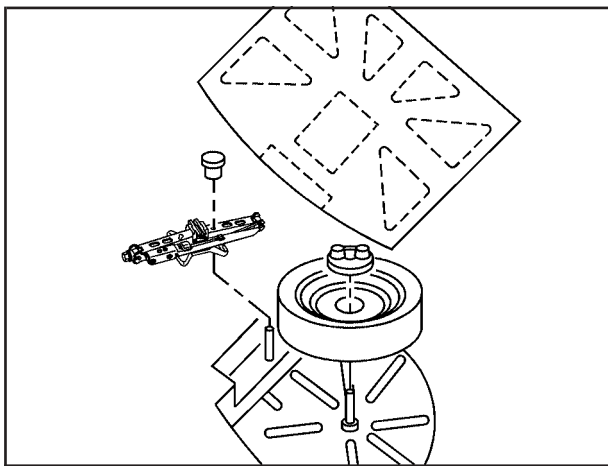

Wagon

1. Place the wheel wrench into the clips on the jack.
2. Install the jack in the left side panel of the trunk for sedans or the spare tire compartment for wagons and secure as shown on the jacking instruction label located in the trunk or cargo area.

3. Place the flat tire, face down, into the spare tire compartment. When placing an aluminum flat tire into the spare tire compartment, be very careful to avoid scraping the wheel face on the hold-down bolt and other hard surfaces. The hold-down bolt should pass through the rear most wheel vent hold. The flat tire will protrude above the trunk floor in this position.
4. Place the nut onto the hold-down bolt and tighten down until it is snug.

The compact spare is for temporary use only. Replace the compact spare tire with a full-size tire as soon as you can. See the storage instructions label to replace your compact spare into your trunk or cargo area separately.

Store the flat tire in the compact spare tire compartment and secure the adapter, extension (aluminum wheel only) and wing bolt. Store the jack and wheel wrench in the foam tray.

Compact Spare Tire

Although the compact spare tire was fully inflated when your vehicle was new, it can lose air after a time. Check the inflation pressure regularly. It should be 60 psi (420 kPa).

After installing the compact spare tire on your vehicle, you should stop as soon as possible and make sure your compact spare tire is correctly inflated. The compact spare tire is made to perform well at speeds up to 65 mph (105 km/h) for distances up to 3,000 miles (5 000 km), so you can finish your trip and have your full-size tire repaired or replaced where you want. Of course, it is best to replace your spare with a full-size tire as soon as you can. Your spare will last longer and be in good shape in case you need it again.

Notice: When the compact spare is installed, don't take your vehicle through an automatic car wash with guide rails. The compact spare can get caught on the rails. That can damage the tire and wheel, and maybe other parts of your vehicle.

Do not use your compact spare tire on other vehicles.

And do not mix your compact spare tire or wheel with other wheels or tires. They won't fit. Keep your compact spare tire and its wheel together.

Notice: Tire chains won't fit your compact spare. Using them can damage your vehicle and can damage the chains too. Don't use tire chains on your compact spare.

Appearance Care

Remember, cleaning products can be hazardous. Some are toxic. Others can burst into flames if you strike a match or get them on a hot part of the vehicle. Some are dangerous if you breathe their fumes in a closed space. When you use anything from a container to clean your vehicle, be sure to follow the manufacturer's warnings and instructions. And always open your doors or windows when you are cleaning the inside.

Never use these to clean your vehicle:

- Gasoline
- Benzene
- Naphtha
- Carbon Tetrachloride
- Acetone
- Paint Thinner
- Turpentine
- Lacquer Thinner
- Nail Polish Remover

They can all be hazardous — some more than others — and they can all damage your vehicle, too.

Do not use any of these unless this manual says you can. In many uses, these will damage your vehicle:

- Alcohol
- Laundry Soap
- Bleach
- Reducing Agents

Cleaning the Inside of Your Vehicle

Use a vacuum cleaner often to get rid of dust and loose dirt. Wipe vinyl, leather, plastic and painted surfaces with a clean, damp cloth.

Cleaning Fabric/Carpet

Your dealer has cleaners for the cleaning of fabric and carpet. They will clean normal spots and stains very well.

You can get GM-approved cleaning products from your dealer. See *Vehicle Care/Appearance Materials* on page 5-89.

Here are some cleaning tips:

- Always read the instructions on the cleaner label.
- Clean up stains as soon as you can — before they set.
- Carefully scrape off any excess stain.

- Use a clean cloth or sponge, and change to a clean area often. A soft brush may be used if stains are stubborn.
- If a ring forms on fabric after spot cleaning, clean the entire area immediately or it will set.

Using Cleaner on Fabric

1. Vacuum and brush the area to remove any loose dirt.
2. Always clean a whole trim panel or section. Mask surrounding trim along stitch or welt lines.
3. Follow the directions on the container label.
4. Apply cleaner with a clean sponge. Do not saturate the material and do not rub it roughly.
5. As soon as you have cleaned the section, use a sponge to remove any excess cleaner.
6. Wipe cleaned area with a clean, water-dampened towel or cloth.
7. Wipe with a clean cloth and let dry.

Special Fabric Cleaning Problems

Stains caused by such things as catsup, coffee (black), egg, fruit, fruit juice, milk, soft drinks, vomit, urine and blood can be removed as follows:

1. Carefully scrape off excess stain, then sponge the soiled area with cool water.
2. If a stain remains, follow the cleaner instructions described earlier.
3. If an odor lingers after cleaning vomit or urine, treat the area with a water/baking soda solution: 1 teaspoon (5 ml) of baking soda to 1 cup (250 ml) of lukewarm water.
4. Let dry.

Stains caused by candy, ice cream, mayonnaise, chili sauce and unknown stains can be removed as follows:

1. Carefully scrape off excess stain.
2. First, clean with cool water and allow to dry completely.
3. If a stain remains, follow the cleaner instructions described earlier.

Cleaning Vinyl

Use warm water and a clean cloth.

- Rub with a clean, damp cloth to remove dirt. You may have to do this more than once.
- Things like tar, asphalt and shoe polish will stain if you do not get them off quickly. Use a clean cloth and vinyl cleaner. See your dealer for this product.

Cleaning the Top of the Instrument Panel

Use only mild soap and water to clean the top surfaces of the instrument panel. Sprays containing silicones or waxes may cause annoying reflections in the windshield and even make it difficult to see through the windshield under certain conditions.

Cleaning Interior Plastic Components

Use only a mild soap and water solution on a soft cloth or sponge. Commercial cleaners may affect the surface finish.

Cleaning Glass Surfaces

Glass should be cleaned often. GM Glass Cleaner or a liquid household glass cleaner will remove normal tobacco smoke and dust films on interior glass. See *Vehicle Care/Appearance Materials on page 5-89*.

Notice: If you use abrasive cleaners when cleaning glass surfaces on your vehicle, you could scratch the glass and/or cause damage to the rear window defogger and the integrated radio antenna. When cleaning the glass on your vehicle, use only a soft cloth and glass cleaner.

Care of Safety Belts

Keep belts clean and dry.

CAUTION:

Do not bleach or dye safety belts. If you do, it may severely weaken them. In a crash, they might not be able to provide adequate protection. Clean safety belts only with mild soap and lukewarm water.

Weatherstrips

Silicone grease on weatherstrips will make them last longer, seal better, and not stick or squeak. Apply silicone grease with a clean cloth. During very cold, damp weather more frequent application may be required. See *Recommended Fluids and Lubricants on page 6-12*.

Cleaning the Outside of Your Vehicle

The paint finish on your vehicle provides beauty, depth of color, gloss retention and durability.

Washing Your Vehicle

The best way to preserve your vehicle's finish is to keep it clean by washing it often with lukewarm or cold water.

Don't wash your vehicle in the direct rays of the sun. Use a car washing soap. Don't use strong soaps or chemical detergents. Be sure to rinse the vehicle well, removing all soap residue completely. You can get approved cleaning products from your retailer. See *Vehicle Care/Appearance Materials on page 5-89*. Don't use cleaning agents that are petroleum based, or that contain acid or abrasives. All cleaning agents should be flushed promptly and not allowed to dry on the surface, or they could stain. Dry the finish with a soft, clean chamois or an all-cotton towel to avoid surface scratches and water spotting.

High pressure car washes may cause water to enter your vehicle.

Cleaning Exterior Lamps/Lenses

Use only lukewarm or cold water, a soft cloth and a car washing soap to clean exterior lamps and lenses. Follow instructions under "Washing Your Vehicle."

Finish Care

Occasional waxing or mild polishing of your vehicle by hand may be necessary to remove residue from the paint finish. You can get approved cleaning products from your retailer. See *Vehicle Care/Appearance Materials* on page 5-89.

Your vehicle has a "basecoat/clearcoat" paint finish. The clearcoat gives more depth and gloss to the colored basecoat. Always use waxes and polishes that are non-abrasive and made for a basecoat/clearcoat paint finish.

Notice: Machine compounding or aggressive polishing on a basecoat/clearcoat paint finish may damage it. Use only non-abrasive waxes and polishes that are made for a basecoat/clearcoat paint finish on your vehicle.

Foreign materials such as calcium chloride and other salts, ice melting agents, road oil and tar, tree sap, bird droppings, chemicals from industrial chimneys, etc., can damage your vehicle's finish if they remain on painted surfaces.

Wash the vehicle as soon as possible. If necessary, use non-abrasive cleaners that are marked safe for painted surfaces to remove foreign matter.

Exterior painted surfaces are subject to aging, weather and chemical fallout that can take their toll over a period of years. You can help to keep the paint finish looking new by keeping your vehicle garaged or covered whenever possible.

Cleaning Windshield, Backglass and Wiper Blades

If the windshield is not clear after using the windshield washer, or if the wiper blade chatters when running, wax, sap or other material may be on the blade or windshield.

Clean the outside of the windshield with a full-strength glass cleaning liquid. The windshield is clean if beads do not form when you rinse it with water.

Grime from the windshield will stick to the wiper blades and affect their performance. Clean the blade by wiping vigorously with a cloth soaked in full-strength windshield washer solvent. Then rinse the blade with water.

Check the wiper blades and clean them as necessary; replace blades that look worn.

Cleaning Aluminum or Chrome-Plated Wheels

Your vehicle may be equipped with either aluminum or chrome-plated wheels.

Keep your wheels clean using a soft clean cloth with mild soap and water. Rinse with clean water. After rinsing thoroughly, dry with a soft clean towel. A wax may then be applied.

The surface of these wheels is similar to the painted surface of your vehicle. Don't use strong soaps, chemicals, abrasive polishes, abrasive cleaners, cleaners with acid, or abrasive cleaning brushes on them because you could damage the surface. Do not use chrome polish on aluminum wheels.

Use chrome polish only on chrome-plated wheels, but avoid any painted surface of the wheel, and buff off immediately after application.

Don't take your vehicle through an automatic car wash that has silicone carbide tire cleaning brushes. These brushes can also damage the surface of these wheels.

Cleaning Tires

To clean your tires, use a stiff brush with tire cleaner.

Notice: Using petroleum-based tire dressing products on your vehicle may damage the paint finish and/or tires. When applying a tire dressing, always wipe off any overspray from all painted surfaces on your vehicle.

Sheet Metal Damage

If your vehicle is damaged and requires sheet metal repair or replacement, make sure the body repair shop applies anti-corrosion material to parts repaired or replaced to restore corrosion protection.

Original manufacturer replacement parts will provide the corrosion protection while maintaining the warranty.

Finish Damage

Any stone chips, fractures or deep scratches in the finish should be repaired right away. Bare metal will corrode quickly and may develop into major repair expense.

Minor chips and scratches can be repaired with touch-up materials available from your dealer. Larger areas of finish damage can be corrected in your dealer's body and paint shop.

Underbody Maintenance

Chemicals used for ice and snow removal and dust control can collect on the underbody. If these are not removed, corrosion and rust can develop on the underbody parts such as fuel lines, frame, floor pan and exhaust system even though they have corrosion protection.

At least every spring, flush these materials from the underbody with plain water. Clean any areas where mud and debris can collect. Dirt packed in close areas of the frame should be loosened before being flushed. Your dealer or an underbody car washing system can do this for you.

Chemical Paint Spotting

Some weather and atmospheric conditions can create a chemical fallout. Airborne pollutants can fall upon and attack painted surfaces on your vehicle. This damage can take two forms: blotchy, ring-shaped discolorations, and small, irregular dark spots etched into the paint surface.

Although no defect in the paint job causes this, GM will repair, at no charge to the owner, the surfaces of new vehicles damaged by this fallout condition within 12 months or 12,000 miles (20 000 km) of purchase, whichever occurs first.

Vehicle Care/Appearance Materials

See your Saturn retailer for more information on purchasing the following products.

Vehicle Care/Appearance Materials

Description	Usage
Polishing Cloth Wax-Treated	Interior and exterior polishing cloth.
Car Wash Soap	Cleans Exterior
Non-Abrasive Wax	Made to use on basecoat/clearcoat paint finish
Tar and Road Oil Remover	Removes tar, road oil and asphalt.
Chrome Cleaner and Polish	Use on chrome or stainless steel.
White Sidewall Tire Cleaner	Removes soil and black marks from whitewalls.
Vinyl Cleaner	Cleans vinyl tops, upholstery and convertible tops.

Vehicle Care/Appearance Materials (cont'd)

Description	Usage
Glass Cleaner	Removes dirt, grime, smoke and fingerprints.
Chrome and Wire Wheel Cleaner	Removes dirt and grime from chrome wheels and wire wheel covers.
Finish Enhancer	Removes dust, fingerprints, and surface contaminants, Spray on wipe off.
Swirl Remover Polish	Removes swirl marks, fine scratches and other light surface contamination.
Cleaner Wax	Removes light scratches and protects finish.
Foaming Tire Shine Low Gloss	Cleans, shines and protects in one easy step, no wiping necessary.

Vehicle Care/Appearance Materials (cont'd)

Description	Usage
Wash Wax Concentrate	Medium foaming shampoo. Cleans and lightly waxes. Biodegradable and phosphate free.
Spot Lifter	Quickly and easily removes spots and stains from carpets, vinyl and cloth upholstery.
Odor Eliminator	Odorless spray odor eliminator used on fabrics, vinyl, leather and carpet.
See your Saturn parts department for these products. See <i>Recommended Fluids and Lubricants</i> on page 6-12.	

Vehicle Identification

Vehicle Identification Number (VIN)



This is the legal identifier for your vehicle. It appears on a plate in the front corner of the instrument panel, on the driver's side. You can see it if you look through the windshield from outside your vehicle. The VIN also appears on the Vehicle Certification and Service Parts labels and the certificates of title and registration.

Engine Identification

The 8th character in your VIN is the engine code. This code will help you identify your engine, specifications and replacement parts.

Service Parts Identification Label

You'll find this label on your spare tire cover. It's very helpful if you ever need to order parts. On this label is:

- your VIN,
- the model designation,
- paint information and
- a list of all production options and special equipment.

Be sure that this label is not removed from the vehicle.

Electrical System

Add-On Electrical Equipment

Notice: Don't add anything electrical to your vehicle unless you check with your dealer first. Some electrical equipment can damage your vehicle and the damage wouldn't be covered by your warranty. Some add-on electrical equipment can keep other components from working as they should.

Your vehicle has an air bag system. Before attempting to add anything electrical to your vehicle, see *Servicing Your Air Bag-Equipped Vehicle on page 1-71*.

Windshield Wiper Fuses

The windshield wiper motor is protected by a circuit breaker and a fuse. If the motor overheats due to heavy snow or ice, the wiper will stop until the motor cools. If the overload is caused by some electrical problem, have it fixed.

Power Windows and Other Power Options

Circuit breakers in the fuse panel protect the power windows and other power accessories. When the current load is too heavy, the circuit breaker opens and closes, protecting the circuit until the problem is fixed.

Fuses and Circuit Breakers

The wiring circuits in your vehicle are protected from short circuits by fuses. This greatly reduces the chance of circuit overload and fire caused by electrical problems.

There are three fuse blocks — the underhood fuse block, the driver's side floor console fuse block and the passenger's side floor console fuse block.

To identify and check fuses and relays, refer to the Fuse Usage Chart on the inside surface of the fuse panel door.

Floor Console Fuse Blocks

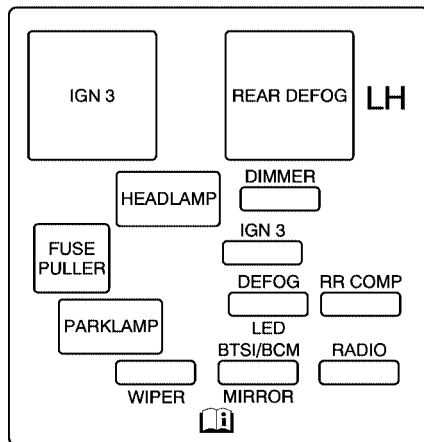

The driver's side instrument panel is located by the driver's left leg.

Use a key or a coin to remove the fuse panel door and access the fuses and relays.

Fuses	Usage
RADIO	Audio, OnStar®, Rear Seat DVD (Option)
WIPER	Windshield Washers and Wipers (Front)
IGN 3	Left Heated Seat Switch, Right Heated Seat Switch, Air Conditioning, Rear Defogger Relay
DEFOG LED	Rear Defog LED
BTSI/BCM/ MIRROR	Brake Transaxle Shift Interlock, Body Control Module, Power Mirror
DIMMER	Dimmer Switch
RR COMP LP	Trunk Compartment Lamp

Relays	Usage
RR DEFOG	Rear Defogger
IGN 3	Ignition Switch
PARKLAMP	Park Lamps
HEADLAMP	Headlamps

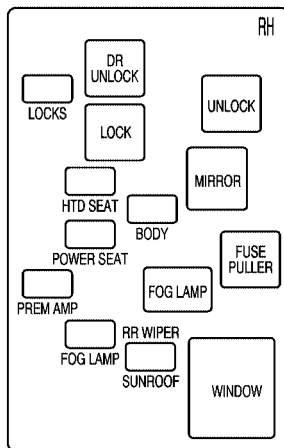

The passenger's side fuse block is located by the passenger's right leg.

Use a key or a coin to remove the fuse panel door and access the fuses and relays.

Fuses	Usage
LOCKS	Power Door Locks
BODY	Power Door Locks, Heated Mirror Relay, Liftgate Latch
POWER SEAT	Power Seat
FOG LAMP	Fog Lamps
PREM AMP/MCS	Premium Sound System Amplifier
HEATED SEATS	Seat Heater
RR WIPER/ SUN ROOF	Rear Wiper/Washer (Wagon)

Relays	Usage
POWER WINDOW	Power Windows, Power Sunroof
DRIVER DOOR UNLOCK RELAY	Driver Door Unlock
DOOR UNLOCK RELAY	Door Unlock
DOOR LOCK RELAY	Door Lock
HEATED MIRROR	Power Mirrors
FOG LAMP	Fog Lamps

Engine Compartment Fuse Block



The engine compartment fuse block is located in the forward part of the engine compartment near the battery.

Fuses	Usage
IGN 1/2	Ignition switch
IGN 0/3/CR	Ignition switch
COOL 1	Cooling fan module
COOL 2	Cooling fan module
ABS 1	Anti-Lock Brake System
ABS 2	Anti-Lock Brake System

Fuses	Usage
HVAC BLOWER	High Blower
HORN	Horn
R HDLP	Right Headlamps
L HDLP	Left Headlamps
A/C	Air Conditioning System
LIGHTER	Cigarette Lighter
AUX POWER	Power Outlet
I/P BATT RT	Passenger's Side Instrument Panel Fuse Block
CONTROLS B+	Powertrain Control Module (2.2L L4 (L61)), Engine Control Module (3.0L V6 (L81)), Transaxle Control Module (3.0L V6 (L81))
BCM 2	Body Control Module
BCM/ECM/CRUISE/ABS	Body Control Module, Engine Control Module, Cruise Control, ABS
EIS	Electronic Ignition System (2.2L L4 (L61))
IGN	Ignition Coils (3.0L V6 (L81))

Fuses	Usage
INJ	Fuel Injectors (2.2L L4 (L61))
BACK-UP/TURN	Backup Lamps, Coolant Level Switch
BRAKE	Brake Lamps
FUEL PUMP	Fuel Pump Relay
IGN 0	Park Neutral Position Switch, Powertrain Control Module
CRUISE SW	Cruise Control Switch
CONTROLS IGN 1	Cooling Fan Control Module, Powertrain Control Module, Transaxle (2.2L L4 (L61)), Transaxle Control Module (3.0L V6 (L81))
IGN 1	Instrument Cluster, Coolant Level Switch, Air Bag, Electronic PRND321
BCM/CLUSTER	Body Control Module, Instrument Cluster, Dimmer Switch

Fuses	Usage
PARK LAMP	Front Park Lamps, Taillamps, Front Marker Lamps, Rear Marker Lamps, License Lamps, Radio Display Lights, I/P Cluster Backlighting, I/P Dimmer, Cigar Lighter Ring, Ashtray Light, PRND321 Light, Climate Control Switch Backlighting
HAZARD	Hazard Flasher, HBTT (Headlamp HI Beam Indicator), I/P Cluster
REAR DEFOG	Rear Window Defogger
RADIO/ON-STAR	Audio System, OnStar [®] , Rear Seat DVD (Option)
CD/DLC	Audio, Data Link Connector, (DLC), Rear Seat DVD (Option)
ING 3	Cruise Clutch Switch, Emissions Controls, Air Conditioner Relay, Heated Oxygen Sensor
ENG CNTL 1	3.0L V6 (L81) Engine
ENG CNTL 2	3.0L V6 (L81) Engine
ENG CNTL 3	3.0L V6 (L81) Engine
A/C DIODE	Air Conditioner Diode

Relays	Usage
A/C	Air Conditioning System
DRL	Daytime Running Lamp
HORN	Horn
MAIN	3.0L V6 (L81) Engine
WIPER	Wiper System
FUEL PUMP	Fuel Pump System
REAR WIPER	Rear Wiper System (Wagon Only)

Circuit Breakers	Usage
WINDOWS/ SUNROOF	Power Window Relay, Sunroof (3.0L V6 (L81))
WINDOW/ SUNROOF/AIR	Power Window Relay, Sunroof and Air Pump Relay (2.2L L4 (L61))

Capacities and Specifications

Application	Capacities	
	English	Metric
Air Conditioning Refrigerant R134a	2.1 lbs.	0.95 kg
Cooling System 2.2L L4 (L61) Engine 3.0L V6 (L81) Engine	7.4 quarts 8.5 quarts	7.0 L 8.0 L
Engine Oil with Filter	5.0 quarts	4.7 L
Fuel Tank	15.7 gallons	59.4 L
Transaxle	6.9 quarts	6.5 L
Wheel Nut Torque	92 lb ft	125 N•m
All capacities are approximate. When adding, be sure to fill to the approximate level, as recommended in this manual. Recheck fluid level after filling.		

Engine Specifications

Engine	VIN Code	Transaxle	Spark Plug Gap
2.2L L4 (L61)	F	Automatic	0.0450 inches (1.14 mm)
3.0L V6 (L81)	R	Automatic	0.040 inches (1.02 mm)

Section 6 Maintenance Schedule

Maintenance Schedule	6-2	Owner Checks and Services	6-9
Introduction	6-2	At Each Fuel Fill	6-9
Maintenance Requirements	6-2	At Least Once a Month	6-9
Your Vehicle and the Environment	6-2	At Least Once a Year	6-10
Using Your Maintenance Schedule	6-2	Recommended Fluids and Lubricants	6-12
Scheduled Maintenance	6-4	Normal Maintenance Replacement Parts	6-13
Additional Required Services	6-6	Engine Drive Belt Routing	6-14
Maintenance Footnotes	6-7	Maintenance Record	6-15

Maintenance Schedule

Introduction

Important: Keep engine oil at the proper level and change as recommended.

Maintenance Requirements

Notice: Maintenance intervals, checks, inspections, replacement parts and recommended fluids and lubricants as prescribed in this manual are necessary to keep your vehicle in good working condition. Any damage caused by failure to follow scheduled maintenance may not be covered by warranty.

Your Vehicle and the Environment

Proper vehicle maintenance not only helps to keep your vehicle in good working condition, but also helps the environment. All recommended maintenance is important. Improper vehicle maintenance can even affect the quality of the air we breathe. Improper fluid levels or the wrong tire inflation can increase the level of emissions from your vehicle. To help protect our environment, and to keep your vehicle in good condition, be sure to maintain your vehicle properly.

Using Your Maintenance Schedule

We at Saturn want to help you keep your vehicle in good working condition. But we do not know exactly how you will drive it. You may drive very short distances only a few times a week. Or you may drive long distances all the time in very hot, dusty weather. You may use your vehicle in making deliveries. Or you may drive it to work, to do errands or in many other ways.

Because of all the different ways people use their vehicles, maintenance needs vary. You may need more frequent checks and replacements. So please read the following and note how you drive. If you have any questions on how to keep your vehicle in good condition, see your Saturn retailer.

This schedule is for vehicles that:

- carry passengers and cargo within recommended limits. You will find these limits on the tire and loading information label. See *Loading Your Vehicle on page 4-34*.
- are driven on reasonable road surfaces within legal driving limits.
- use the recommended fuel. See *Gasoline Octane on page 5-5*.

The services in *Scheduled Maintenance on page 6-4* should be performed when indicated. See *Additional Required Services on page 6-6* and *Maintenance Footnotes on page 6-7* for further information.

 **CAUTION:**

Performing maintenance work on a vehicle can be dangerous. In trying to do some jobs, you can be seriously injured. Do your own maintenance work only if you have the required know-how and the proper tools and equipment for the job. If you have any doubt, see your GM Goodwrench dealer to have a qualified technician do the work.

Some maintenance services can be complex. So, unless you are technically qualified and have the necessary equipment, you should have your Saturn retailer do these jobs.

When you go to your Saturn retailer for your service needs, you will know that Saturn-trained and supported service technicians will perform the work using genuine Saturn parts.

If you want to get service information, see *Service Publications Ordering Information on page 7-10*.

Owner Checks and Services on page 6-9 tells you what should be checked, when to check it and what you can easily do to help keep your vehicle in good condition.

The proper replacement parts, fluids and lubricants to use are listed in *Recommended Fluids and Lubricants on page 6-12* and *Normal Maintenance Replacement Parts on page 6-13*. When your vehicle is serviced, make sure these are used. All parts should be replaced and all necessary repairs done before you or anyone else drives the vehicle. We recommend the use of genuine Saturn parts.

Scheduled Maintenance

When the Change Engine Oil light comes on, it means that service is required for your vehicle. Have your vehicle serviced as soon as possible within the next 600 miles (1 000 km). It is possible that, if you are driving under the best conditions, the engine oil life system may not indicate that vehicle service is necessary for over a year. However, your engine oil and filter must be changed at least once a year and at this time the system must be reset. Your Saturn retailer has Saturn-trained service technicians who will perform this work using genuine Saturn parts and reset the system.

If the engine oil life system is ever reset accidentally, you must service your vehicle within 3,000 miles (5 000 km) since your last service. Remember to reset the oil life system whenever the oil is changed. See *Engine Oil on page 5-16* for information on the Engine Oil Life System and resetting the system.

When the Change Engine Oil light appears, certain services, checks and inspections are required. Required services are described in the following for “Maintenance I” and “Maintenance II.” Generally, it is recommended that your first service be Maintenance I, your second service be Maintenance II and that you alternate Maintenance I and Maintenance II thereafter. However, in some cases, Maintenance II may be required more often.

Maintenance I — Use Maintenance I if the Change Engine Oil light comes on within ten months since vehicle was purchased or Maintenance II was performed.

Maintenance II — Use Maintenance II if the previous service performed was Maintenance I. Always use Maintenance II whenever the light comes on ten months or more since the last service or if the light has not come on at all for one year.

Scheduled Maintenance

Service	Maintenance I	Maintenance II
Change engine oil and filter. Reset oil life system. See <i>Engine Oil on page 5-16. An Emission Control Service.</i>	•	•
Visually check for any leaks or damage. See <i>footnote (j).</i>	•	•
Inspect engine air cleaner filter. If necessary, replace filter. See <i>Engine Air Cleaner/Filter on page 5-20. An Emission Control Service. See footnote †.</i>	•	•
Rotate tires and check inflation pressures and wear. See <i>Tires on page 5-54.</i>	•	•
Inspect brake system. See <i>footnote (a).</i>	•	•
Check engine coolant and windshield washer fluid levels and add fluid as needed.	•	•
Perform any needed additional services. See “Additional Required Services” in this section.	•	•
Inspect suspension and steering components. See <i>footnote (b).</i>		•
Inspect engine cooling system. See <i>footnote (c).</i>		•
Inspect wiper blades. See <i>footnote (d).</i>		•
Inspect restraint system components. See <i>footnote (e).</i>		•
Lubricate body components. See <i>footnote (f).</i>		•
Replace passenger compartment air filter. See <i>footnote (k).</i>		•
Inspect throttle system. See <i>footnote (g).</i>		•

Additional Required Services

The following services should be performed at the first maintenance service (I or II) after the indicated miles (kilometers) shown for each item.

Additional Required Services

Service and Miles (Kilometers)	25,000 (41 500)	50,000 (83 000)	75,000 (125 000)	100,000 (166 000)	125,000 (207 500)	150,000 (240 000)
Inspect fuel system for damage or leaks.	•	•	•	•	•	•
Inspect exhaust system for loose or damaged components.	•	•	•	•	•	•
Replace engine air cleaner filter. See <i>Engine Air Cleaner/Filter on page 5-20. An Emission Control Service.</i>	•	•	•	•	•	•
Change automatic transaxle fluid and filter (severe service only). See <i>footnote (h).</i>		•		•		•
Replace spark plugs. <i>An Emission Control Service.</i>				•		
Replace engine fuel filter. <i>An Emission Control Service. See footnote †.</i>				•		

Additional Required Services (cont'd)

Service and Miles (Kilometers)	25,000 (41 500)	50,000 (83 000)	75,000 (125 000)	100,000 (166 000)	125,000 (207 500)	150,000 (240 000)
Engine cooling system service (or every 5 years, whichever occurs first). <i>An Emission Control Service. See footnote (i).</i>						•
3.0L V6 engine only: Replace timing belt. <i>An Emission Control Service.</i>				•		
Inspect engine accessory drive belt. <i>An Emission Control Service.</i>	•	•	•	•	•	•

Maintenance Footnotes

† The U.S. Environmental Protection Agency or the California Air Resources Board has determined that the failure to perform this maintenance item will not nullify the emission warranty or limit recall liability prior to the completion of the vehicle's useful life. We, however, urge that all recommended maintenance services be performed at the indicated intervals and the maintenance be recorded.

(a) Visually inspect brake lines and hoses for proper hook-up, binding, leaks, cracks, chafing, etc. Inspect disc brake pads for wear and rotors for surface condition. Inspect other brake parts, including calipers, parking brake, etc.

(b) Visually inspect front and rear suspension and steering system for damaged, loose or missing parts or signs of wear. Inspect power steering lines and hoses for proper hook-up, binding, leaks, cracks, chafing, etc.

(c) Visually inspect hoses and have them replaced if they are cracked, swollen or deteriorated. Inspect all pipes, fittings and clamps; replace with genuine Saturn parts as needed. To help ensure proper operation, a pressure test of the cooling system and pressure cap and cleaning the outside of the radiator and air conditioning condenser is recommended at least once a year.

(d) Visually inspect wiper blades for wear or cracking. Replace blade inserts that appear worn or damaged or that streak or miss areas of the windshield.

(e) Make sure the safety belt reminder light and all your belts, buckles, latch plates, retractors and anchorages are working properly. Look for any other loose or damaged safety belt system parts. If you see anything that might keep a safety belt system from doing its job, have it repaired. Have any torn or frayed safety belts replaced. Also look for any opened or broken air bag coverings, and have them repaired or replaced. (The air bag system does not need regular maintenance.)

(f) Lubricate all key lock cylinders, door hinges and latches, hood hinges and latches, glove box hinges, sunroof (if equipped) and any folding seat hardware. More frequent lubrication may be required when exposed to a corrosive environment. Applying silicone grease on weatherstrips with a clean cloth will make them last longer, seal better and not stick or squeak.

(g) Check system for interference or binding and for damaged or missing parts. Replace parts as needed. Replace any components that have high effort or excessive wear. Do not lubricate accelerator or cruise control cables.

(h) Change automatic transaxle fluid and filter if the vehicle is mainly driven under one or more of these conditions:

- In heavy city traffic where the outside temperature regularly reaches 90°F (32°C) or higher.
- In hilly or mountainous terrain.
- When doing frequent trailer towing.
- Uses such as found in taxi, police or delivery service.

If you do not use your vehicle under any of these conditions, the fluid and filter do not require changing.

(i) Drain, flush and refill cooling system. See Engine Coolant on page 5-23 for what to use. Inspect hoses. Clean radiator, condenser, pressure cap and filler neck. Pressure test the cooling system and pressure cap.

(j) A fluid loss in any vehicle system could indicate a problem. Have the system inspected and repaired and the fluid level checked. Add fluid if needed.

(k) Or every 12 months, whichever occurs first. If you drive regularly under dusty conditions, the filter may require replacement more often.

Owner Checks and Services

These owner checks and services should be performed at the intervals specified to help ensure the safety, dependability and emission control performance of your vehicle. Your Saturn retailer can assist you with these checks and services.

Be sure any necessary repairs are completed at once. Whenever any fluids or lubricants are added to your vehicle, make sure they are the proper ones, as shown in *Recommended Fluids and Lubricants* on page 6-12.

At Each Fuel Fill

It is important to perform these underhood checks at each fuel fill.

Engine Oil Level Check

Check the engine oil level and add the proper oil if necessary. See *Engine Oil* on page 5-16 for further details.

Notice: It is important to check your oil regularly and keep it at the proper level. Failure to keep your engine oil at the proper level can cause damage to your engine not covered by your warranty.

Engine Coolant Level Check

Check the engine coolant level and add DEX-COOL® coolant mixture if necessary. See *Engine Coolant* on page 5-23 for further details.

Windshield Washer Fluid Level Check

Check the windshield washer fluid level in the windshield washer tank and add the proper fluid if necessary.

At Least Once a Month

Tire Inflation Check

Visually inspect your tires and make sure tires are inflated to the correct pressures. Do not forget to check your spare tire. See *Tires* on page 5-54 for further details.

Cassette Tape Player Service

Clean cassette tape player. Cleaning should be done every 50 hours of tape play. See *Audio System(s)* on page 3-41 for further details.

At Least Once a Year

Starter Switch Check

CAUTION:

When you are doing this inspection, the vehicle could move suddenly. If the vehicle moves, you or others could be injured.

1. Before you start, be sure you have enough room around the vehicle.
2. Firmly apply both the parking brake and the regular brake. See *Parking Brake* on page 2-27 if necessary.
Do not use the accelerator pedal, and be ready to turn off the engine immediately if it starts.
3. Try to start the engine in each gear. The starter should work only in PARK (P) or NEUTRAL (N). If the starter works in any other position, contact your retailer for service.

Automatic Transaxle Shift Lock Control System Check

CAUTION:

When you are doing this inspection, the vehicle could move suddenly. If the vehicle moves, you or others could be injured.

1. Before you start, be sure you have enough room around the vehicle. It should be parked on a level surface.
2. Firmly apply the parking brake. See *Parking Brake* on page 2-27 if necessary.
Be ready to apply the regular brake immediately if the vehicle begins to move.
3. With the engine off, turn the key to the RUN position, but do not start the engine. Without applying the regular brake, try to move the shift lever out of PARK (P) with normal effort. If the shift lever moves out of PARK (P), contact your retailer for service.

Ignition Transaxle Lock Check

While parked, and with the parking brake set, try to turn the ignition key to OFF in each shift lever position.

- The key should turn to OFF only when the shift lever is in PARK (P).
- The key should come out only in OFF.

Contact your retailer if service is required.

Parking Brake and Automatic Transaxle Park (P) Mechanism Check

CAUTION:

When you are doing this check, your vehicle could begin to move. You or others could be injured and property could be damaged. Make sure there is room in front of your vehicle in case it begins to roll. Be ready to apply the regular brake at once should the vehicle begin to move.

Park on a fairly steep hill, with the vehicle facing downhill. Keeping your foot on the regular brake, set the parking brake.

- To check the parking brake's holding ability: With the engine running and transaxle in NEUTRAL (N), slowly remove foot pressure from the regular brake pedal. Do this until the vehicle is held by the parking brake only.
- To check the PARK (P) mechanism's holding ability: With the engine running, shift to PARK (P). Then release the parking brake followed by the regular brake.

Contact your retailer if service is required.

Underbody Flushing Service

At least every spring, use plain water to flush any corrosive materials from the underbody. Take care to clean thoroughly any areas where mud and other debris can collect.

Recommended Fluids and Lubricants

Fluids and lubricants identified below by name, part number or specification may be obtained from your dealer.

Usage	Fluid/Lubricant
Engine Oil	Engine oil which meets GM Standard GM6094M and displays the American Petroleum Institute Certified for Gasoline Engines starburst symbol. To determine the proper viscosity for your vehicle's engine, see <i>Engine Oil on page 5-16</i> .
Engine Coolant	50/50 mixture of clean, drinkable water and use only DEX-COOL [®] Coolant. See <i>Engine Coolant on page 5-23</i> .
Hydraulic Brake System	Delco Supreme 11 Brake Fluid or equivalent DOT-3 brake fluid.
Windshield Washer Solvent	Optikleen [®] Washer Solvent.
Parking Brake Cable Guides	Chassis Lubricant (GM Part No. 12377985, in Canada 88901242) or lubricant meeting requirements of NLGI #2, Category LB or GC-LB.

Usage	Fluid/Lubricant
Power Steering System	Power Steering Fluid (Saturn Part No. 21007583 or GM Part No. U.S. 89021184, in Canada 89021186).
Automatic Transaxle	DEXRON [®] -III Automatic Transmission Fluid.
Key Lock Cylinders	Multi-Purpose Lubricant, Superlube (GM Part No. U.S. 12346241, in Canada 10953474).
Hood Latch Assembly, Secondary Latch, Pivots, Spring Anchor and Release Pawl	Lubriplate Lubricant Aerosol (Saturn Part No. 21038869 or GM Part No. U.S. 12346293, in Canada 992723) or lubricant meeting requirements of NLGI #2, Category LB or GC-LB.
Hood, Trunk and Door Hinges	Multi-Purpose Lubricant, Superlube (GM Part No. U.S. 12346241, in Canada 10953474).
Sunroof Track	Lubriplate Lubricant Aerosol (Saturn Part No. 21038869 or GM Part No. U.S. 12346293, in Canada 992723) or lubricant meeting requirements of NLGI #2, Category LB or GC-LB.
Weatherstrip Conditioning	Dielectric Silicone Grease (GM Part No. U.S. 12345579, in Canada 992887).

Normal Maintenance Replacement Parts

Replacement parts identified below by name, part number, or specification can be obtained from your retailer.

Part	Saturn Part Number	AC Delco Part Number
Engine Air Cleaner/Filter	90571362	—
Engine Oil Filter 3.0L V6 (L81) 2.2L L4 (L61)	21018826 22685727	—
Passenger Compartment Air Filter Element	52493319	—
Spark Plugs 3.0L V6 (L81) 2.2L L4 (L61)	09195166 12569190	FLR9LTE* 41-981
Windshield Wiper Blade Type – Shepherd's hook Length – 22.0 inches (56.0 cm)	—	8-2221
Rear Wiper Blade – 13.0 Inches (33.0 cm)	09152402	—
*Bosch Part Number.	—	—

Engine Drive Belt Routing

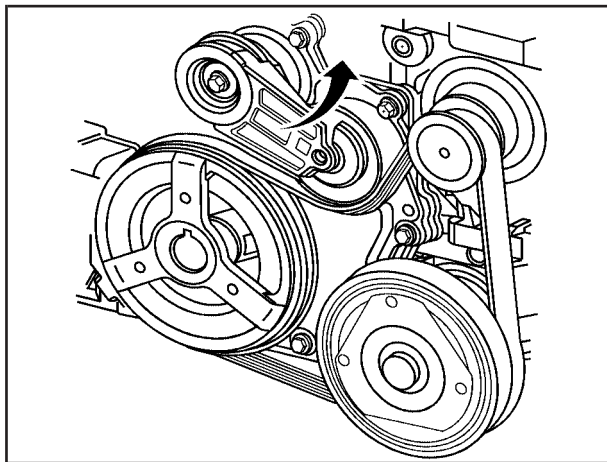

2.2L Four Cylinder (L61) Engine

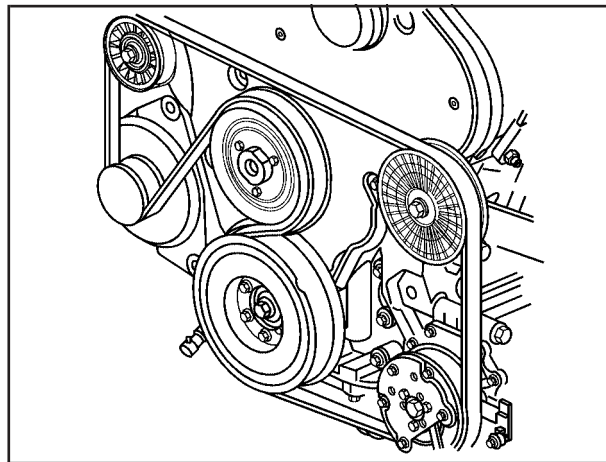

3.0L V6 (L81) Engine

Maintenance Record

After the scheduled services are performed, record the date, odometer reading, who performed the service and the type of services performed in the boxes provided. See *Maintenance Requirements on page 6-2* in this section. Any additional information from *Owner Checks and Services on page 6-9* can be added on the following record pages. Also, you should retain all maintenance receipts.

Maintenance Record

Date	Odometer Reading	Serviced By	Maintenance I or Maintenance II	Services Performed

Maintenance Record (cont'd)

Date	Odometer Reading	Serviced By	Maintenance I or Maintenance II	Services Performed

Section 7 Customer Assistance and Information

Customer Assistance and Information	7-2	Reporting Safety Defects	7-9
Customer Satisfaction Procedure	7-2	Reporting Safety Defects to the United States	
Online Owner Center	7-4	Government	7-9
Customer Assistance for Text Telephone (TTY)		Reporting Safety Defects to the Canadian	
Users	7-5	Government	7-10
GM Mobility Program for Persons with		Reporting Safety Defects to Saturn	7-10
Disabilities	7-5	Service Publications Ordering Information	7-10
Roadside Assistance Program	7-6		
Vehicle Data Collection and Event Data			
Recorders	7-8		

Customer Assistance and Information

Customer Satisfaction Procedure

Your satisfaction and goodwill are important to your retailer and to Saturn. Together we are committed to providing our customers with unparalleled service, before, during and after the purchase of a Saturn vehicle, for total customer satisfaction. We call this the Saturn Difference. Normally, any concerns with the sales transaction or the operation of your vehicle will be resolved by your retailer's sales or service departments. If, for any reason, your ownership experience falls below your expectations, we suggest you take the following action:

STEP ONE: Contact the Retail Customer Assistance Liaison. Any member of the retail management team has the authority and the desire to resolve your concerns. Normally, concerns can be quickly resolved at this level.

STEP TWO: Should you need additional assistance, contact the Saturn Customer Assistance Center by calling 1-800-553-6000. In Canada, contact the Saturn Customer Communication Centre at 1-800-263-1999. A Saturn Customer Assistance Center team member will handle your call and assist in providing product and warranty information, the nearest retailer location, roadside assistance, brochures, literature and discuss any concerns you may have.

We encourage you to call the toll-free number in order to give your inquiry prompt attention. Please have the following information available to give the Customer Assistance Representative:

- Vehicle Identification Number. (You will find this 17-digit number on the vehicle registration or title, on the upper driver's side corner of the dash or on your roadside assistance key card.)
- The name of your selling and servicing retail facility.
- Vehicle delivery date and present mileage.
- Your daytime and evening phone numbers.

If you wish to write to the Saturn Customer Assistance Center, our address is:

Saturn Customer Assistance Center
100 Saturn Parkway
Mail Code 371-999-S24 Spring Hill, TN 37174-1500

In Canada, write to:

Saturn Customer Communication Centre
General Motors of Canada Ltd.
1908 Colonel Sam Drive Oshawa, Ontario L1H 8P7

When contacting Saturn, please remember that your concern will likely be resolved at a retailer's facility. That is why we suggest you follow Step One first if you have a concern.

STEP THREE: Both Saturn and its retailers are committed to making sure you are completely satisfied with your Saturn vehicle. However, if you continue to remain unsatisfied after following the procedure outlined in Steps One and Two, Saturn and its retailers offer the additional assistance of a neutral party through our voluntary participation in a mediation/arbitration program called BBB Auto Line.

Canadian owners refer to your Warranty and Owner Assistance Information booklet, located in the front cover pocket of your owner's handbook, for information on the Canadian Motor Vehicle Arbitration Plan (CAMVAP).

The BBB Auto Line Program is an out-of-court program administered by the Council of Better Business Bureaus to settle automotive disputes regarding vehicle repairs or the interpretation of the New Vehicle Limited Warranty. This program is available at no cost to you, our customer.

We ask that you not resort to BBB Auto Line until after Saturn and its retailers have been given the opportunity to satisfy your vehicle concerns. However, U.S. residents may file a claim at any time by contacting your local Better Business Bureau at 1-800-955-5100.

Although you may be required to resort to this informal dispute resolution program prior to filing a court action, use of the program is free of charge and your case will generally be heard within 40 days. If you do not agree with the decision given in your case, you may reject it and proceed with any other venue for relief available to you.

You may contact the BBB Auto Line Program by using the toll-free telephone number or by writing them at the following address:

BBB Auto Line Program
Council of Better Business Bureaus, Inc.
4200 Wilson Boulevard
Suite 800
Arlington, VA 22203-1804

This program is available in all 50 states and the District of Columbia. Eligibility is limited by vehicle age, mileage and other factors. Saturn Corporation reserves the right to change eligibility limitations and/or discontinue its participation in this program.

Online Owner Center

The Owner Center is a resource for your GM ownership needs. You can find your specific vehicle information all in one place.

The Owner Center allows you to:

- Get e-mail service reminders.
- Access information about your specific vehicle, including tips and videos and an electronic version of this owner's manual. (United States only)
- Keep track of your vehicle's service history and maintenance schedule.
- Find GM dealers for service nationwide.
- Receive special promotions and privileges only available to members. (United States only)

Refer to the web for updated information.

To register your vehicle, visit www.MyGMLink.com. (United States) or My GM Canada within www.gmcanada.com (Canada).

Customer Assistance for Text Telephone (TTY) Users

To assist owners who have hearing difficulties, Saturn has installed special TDD (Telecommunication Devices for the Deaf) equipment in its Saturn Customer Assistance Center.

Any hearing- or speech-impaired customer who has access to a TDD or to a conventional Text Telephone (TTY) can communicate with Saturn by dialing 1-800-TDD-6000. TTY users in Canada may dial 1-800-263-3830.

GM Mobility Program for Persons with Disabilities

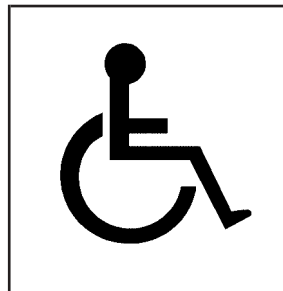

This program, available to qualified applicants, can reimburse you up to \$1,000 toward eligible aftermarket driver or passenger adaptive equipment you may require for your vehicle (hand controls, wheelchair/scooter lifts, etc.).

This program can also provide you with free resource information, such as area driver assessment centers and mobility equipment installers. The offer is available for a limited period of time from the date of vehicle purchase/lease.

For more details, or to determine your vehicle's eligibility, see your Saturn retailer or call the Saturn Customer Assistance Center at 1-800-553-6000. Text telephone (TTY) users, call 1-800-833-6000.

In Canada, customers may call the Saturn Customer Communication Centre at 1-800-263-1999. TTY users in Canada may call 1-800-263-3830.

Roadside Assistance Program

Security While You Travel

For vehicles purchased in the U.S. call 1-800-553-6000 (TTY: 1-800-833-6000).

For vehicles purchased in Canada call 1-800-268-6800.

As the proud owner of a new Saturn vehicle, you are automatically enrolled in the Saturn Roadside Assistance Program. This value-added service is intended to provide you with peace of mind as you drive in the city or travel the open road. Saturn's Roadside Assistance toll-free number is staffed by courteous and capable Roadside Assistance Representatives who are available 24 hours a day, 365 days a year.

We will provide the following services during the Bumper-to-Bumper warranty period at no expense to you:

- **Fuel Delivery:** Delivery of enough fuel (\$5 maximum) for the customer to get to the nearest service station.
- **Lock-out Service (identification required):** Replacement keys or locksmith service will be covered at no charge if you are unable to gain entry into your vehicle. Delivery of the replacement key will be covered within 10 miles.
- **Emergency Tow:** Tow to the nearest Saturn retailer for warranty service or in the event of a vehicle-disabling accident. Assistance when the vehicle is mired in sand, mud or snow.
- **Flat Tire Change:** Installation of a spare tire will be covered at no charge. (The customer is responsible for the repair or replacement of the tire if not covered by a warrantable failure.)
- **Jump Start:** No-start occurrences which require a battery jump start will be covered at no charge.
- **Saturn Retailer Locator Service**

In many instances, mechanical failures are covered under Saturn's Bumper-to-Bumper warranty. However, when other services are utilized, our Roadside Assistance Representatives will explain any payment obligations you might incur.

For prompt and efficient assistance when calling, please provide the following to the Roadside Assistance Representatives:

- Your name, home address, and home telephone number
- Telephone number of your location
- Location of the vehicle
- Model, year, color, and license plate number
- Mileage, Vehicle Identification Number and delivery date of the vehicle
- Description of the problem

While we hope you never have the occasion to use our service, it is added security while traveling for you and your family. Remember we are only a phone call away. Saturn Roadside Assistance: 1-800-553-6000; text telephone (TTY) users, call 1-800-833-6000.

Saturn reserves the right to limit services or reimbursement to an owner or driver when, in Saturn's judgment, the claims become excessive in frequency or type of occurrence.

Roadside Assistance is not part of or included in the coverage provided by the New Vehicle Limited Warranty. Saturn reserves the right to make any changes or discontinue the Roadside Assistance program at any time without notification.

Canadian Roadside Assistance

Vehicles purchased in Canada have an extensive Saturn Roadside Assistance program accessible from anywhere in Canada or the United States. Please refer to the Warranty and Owner Assistance Information book.

Vehicle Data Collection and Event Data Recorders

Your vehicle, like other modern motor vehicles, has a number of sophisticated computer systems that monitor and control several aspects of the vehicle's performance. Your vehicle uses on-board vehicle computers to monitor emission control components to optimize fuel economy, to monitor conditions for air bag deployment and, if so equipped, to provide anti-lock braking and to help the driver control the vehicle in difficult driving situations. Some information may be stored during regular operations to facilitate repair of detected malfunctions; other information is stored only in a crash or near crash event by computer systems commonly called event data recorders (EDR).

In a crash or near crash event, computer systems, such as the Air Bag Sensing and Diagnostic Module (SDM) in your vehicle may record information about the condition of the vehicle and how it was operated, such as engine speed, brake applications, throttle position, vehicle speed, safety belt usage, air bag readiness, air bag performance data, and the severity of a collision. This information has been used to improve vehicle crash performance and may be used to improve crash performance of future vehicles and driving safety. Unlike the data recorders on many airplanes, these on-board systems do not record sounds, such as conversation of vehicle occupants.

To read this information, special equipment is needed and access to the vehicle or the SDM is required. GM will not access information about a crash event or share it with others other than

- with the consent of the vehicle owner or, if the vehicle is leased, with the consent of the lessee,
- in response to an official request of police or similar government office,
- as part of GM's defense of litigation through the discovery process, or
- as required by law.

In addition, once GM collects or receives data, GM may

- use the data for GM research needs,
- make it available for research where appropriate confidentiality is to be maintained and need is shown, or
- share summary data which is not tied to a specific vehicle with non-GM organizations for research purposes.

Others, such as law enforcement, may have access to the special equipment that can read the information if they have access to the vehicle or SDM.

If your vehicle is equipped with OnStar[®], please check the OnStar[®] subscription service agreement or manual for information on its operations and data collection.

Reporting Safety Defects

Reporting Safety Defects to the United States Government

If you believe that your vehicle has a defect which could cause a crash or could cause injury or death, you should immediately inform the National Highway Traffic Safety Administration (NHTSA), in addition to notifying Saturn Corporation.

If NHTSA receives similar complaints, it may open an investigation, and if it finds that a safety defect exists in a group of vehicles, it may order a recall and remedy campaign. However, NHTSA cannot become involved in individual problems between you, your retailer or Saturn Corporation.

To contact NHTSA, you may either call the Auto Safety Hotline toll-free at 1-800-424-9393 (or 366-0123 in the Washington, D.C. area) or write to:

NHTSA, U.S. Department of Transportation
Washington, D.C. 20590

You can also obtain other information about motor vehicle safety from the hotline.

Reporting Safety Defects to the Canadian Government

If you live in Canada, and you believe that your vehicle has a safety defect, you should immediately notify Transport Canada, in addition to notifying General Motors of Canada Limited. You may write to:

Transport Canada
330 Sparks Street
Tower C
Ottawa, Ontario K1A 0N5

Reporting Safety Defects to Saturn

In addition to notifying NHTSA (or Transport Canada) in a situation like this, we certainly hope you'll notify us.

U.S. customers can call the Saturn Customer Assistance Center at 1-800-553-6000, or write:

Saturn Corporation
100 Saturn Parkway
Mail Drop 371-999-S24
Spring Hill, TN 37174-1500

In Canada, please call us at 1-800-263-1999. Or, write to:

Saturn Customer Communication Centre
General Motors of Canada Limited
1908 Colonel Sam Drive
Oshawa, Ontario L1H 8P7

Service Publications Ordering Information

Service Manuals

A variety of publications are available to you. Saturn service manuals are written for trained technicians, and in some cases, specialized tools and equipment are necessary to complete certain repairs. However, the manuals are available to owners who either have the training, or wish to gain a greater understanding of the technical aspect of their Saturn.

For additional publications information or to order publications, call toll free 1-800-2-SATURN or visit win.wallace.com/saturn to order on-line.

In Canada, Saturn service manuals are available by calling toll free 1-800-551-4123.

Owner Publications

Information on how to obtain product bulletins and as described below is applicable only in the fifty U.S. states and the District of Columbia, and only for cars and light trucks with a GVWR less than 10,000 pounds (4 536 kg). Copies of individual bulletins are also at your participating Saturn retailer. You can ask to see them.

In Canada, information relating to product service bulletins can be obtained by contacting your Saturn retailer.

Service Bulletins

Saturn regularly sends its retailers useful service bulletins about Saturn products. Saturn monitors product performance in the field. We then prepare bulletins for servicing our products better. You can get these bulletins, too.

Bulletins cover various subjects. Some pertain to the proper use and care of your vehicle. Some describe costly repairs. Others describe inexpensive repairs which, if done on time with the latest parts, may avoid future costly repairs.

Some bulletins tell a technician how to repair a new or unexpected condition. Others describe a quicker way to fix your vehicle. They can help a technician service your vehicle better.

Most bulletins apply to conditions affecting a small number of vehicles. Your Saturn retailer or a qualified technician may have to determine if a specific bulletin applies to your vehicle. To order Saturn bulletins, call Saturn Publications at 1-800-2-SATURN or visit win.wallace.com/saturn to order on-line.

A

Accessory Power Outlets	3-16
Activating the Theft-Deterrent Feature	3-69
Adding Windshield Washer Fluid	5-35
Additives, Fuel	5-7
Add-On Electrical Equipment	5-91
Adjusting the Speakers (Balance/Fade)	3-44, 3-47, 3-52
Air Bag Readiness Light	3-28
Air Bag Systems	1-62
Adding Equipment to Your Air Bag-Equipped Vehicle	1-72
How Does an Air Bag Restrain?	1-68
Servicing Your Air Bag-Equipped Vehicle	1-71
What Makes an Air Bag Inflate?	1-68
What Will You See After an Air Bag Inflates?	1-69
When Should an Air Bag Inflate?	1-67
Where Are the Air Bags?	1-64
Air Cleaner/Filter, Engine	5-20
Airbag Sensing and Diagnostic Module (SDM)	7-8
AM	3-71
AM-FM Radio	3-42
Antenna, Fixed Mast	3-73
Anti-lock Brake System (ABS)	4-7
Anti-Lock Brake, System Warning Light	3-31
Appearance Care	5-82
Care of Safety Belts	5-85
Chemical Paint Spotting	5-88
Appearance Care (cont.) Cleaning the Inside of Your Vehicle	5-82
Cleaning the Outside of Your Vehicle	5-85
Finish Damage	5-88
Sheet Metal Damage	5-87
Underbody Maintenance	5-88
Vehicle Care/Appearance Materials	5-89
Weatherstrips	5-85
Ashtrays	3-17
Assist Handles	2-41
Audio Output	3-61
Audio System(s)	3-41
AM-FM Radio	3-42
Care of Your Cassette Tape Player	3-72
Care of Your CD and DVD Player	3-73
Care of Your CDs and DVDs	3-73
Fixed Mast Antenna	3-73
Radio with Cassette and CD	3-50
Radio with CD	3-45
Setting the Time	3-41
Theft-Deterrent Feature	3-69
Understanding Radio Reception	3-71
Automatic Climate Control System	3-20
Automatic Dimming Mirror Operation	2-35, 2-37
Automatic Headlamp System	3-14
Automatic Operation	3-21
Automatic Transaxle	2-21
Fluid	5-23
Operation	2-23

B

Backing Up	4-44
Battery	5-39
Battery Replacement	2-7
Battery Run-Down Protection	3-16
Battery Warning Light	3-29
Before Leaving on a Long Trip	4-23
Before You Drive	3-59
Brake	
Parking	2-27
System Warning Light	3-30
Brake Fluid	5-36
Brake Wear	5-38
Brakes	5-36
Braking	4-6
Braking in Emergencies	4-8
Break-In, New Vehicle	2-19
Bulb Replacement	5-46
Center High-Mounted Stoplamp (CHMSL)	5-49, 5-50
Fog Lamps	5-49
Halogen Bulbs	5-46
Headlamps, Front Turn Signal, Sidemarker, and Parking Lamps	5-47
Replacement Bulbs	5-52
Taillamps, Turn Signal, Stoplamps and Back-up Lamps	5-50, 5-52
Buying New Tires	5-64

C

California Fuel	5-6
Canadian Owners	ii
Canadian Roadside Assistance	7-7
Capacities and Specifications	5-98
Carbon Monoxide	4-26, 4-40, 2-13, 2-31
Care of	
Safety Belts	5-85
Your Cassette Tape Player	3-72
Your CD and DVD Player	3-73
Your CDs and DVDs	3-73
Cargo Cover	2-43
Cassette Tape Messages	3-54
Cassette Tape Player Service	6-9
CD Adapter Kits	3-54
CD Messages	3-49, 3-58
Center Console Storage Area	2-41
Center High-Mounted Stoplamp (CHMSL)	5-49, 5-50
Center Rear Passenger Position (Wagon)	1-31
Chains, Tires	5-68
Check	
Engine Light	3-34
Checking Coolant	5-25
Checking Engine Oil	5-16
Checking Things Under the Hood	5-10
Chemical Paint Spotting	5-88

Child Restraints		Cleaning Glass Surfaces	5-84
Child Restraint Systems	1-42	Cleaning Interior Plastic Components	5-84
Infants and Young Children	1-38	Cleaning the DVD Player	3-68
Lower Anchorages and Top Tethers for		Cleaning the Mirror	2-36, 2-38
Children (LATCH System)	1-50	Cleaning the Top of the Instrument Panel	5-84
Older Children	1-35	Cleaning the Video Screen	3-68
Securing a Child Restraint Designed for the		Cleaning Tires	5-87
LATCH System	1-52	Cleaning Vinyl	5-84
Securing a Child Restraint in a Center Rear		Cleaning Windshield, Backglass and Wiper	
Seat Position	1-56	Blades	5-86
Securing a Child Restraint in a Rear Outside		Climate Control System	3-17
Seat Position	1-54	Air Filter, Passenger Compartment	3-24
Securing a Child Restraint in a Rear Seat		Automatic	3-20
Position	1-52	Outlet Adjustment	3-24
Securing a Child Restraint in the Right Front		Compact Spare Tire	5-81
Seat Position	1-58	Compass Calibration	2-35, 2-37
Top Strap	1-46	Compass Operation	2-37
Top Strap Anchor Location	1-47	Compass Variance	2-35, 2-37
Where to Put the Restraint	1-44	Control of a Vehicle	4-5
Cigarette Lighter	3-17	Coolant	
Cleaning		Engine Temperature Gage	3-33
Inside of Your Vehicle	5-82	Engine Temperature Warning Light	3-32
Outside of Your Vehicle	5-85	Heater, Engine	2-22
Underbody Maintenance	5-88	Low Warning Light	3-33
Weatherstrips	5-85	Surge Tank Pressure Cap	5-26
Cleaning Aluminum or Chrome-Plated Wheels	5-87	Cooling System	5-29
Cleaning Exterior Lamps/Lenses	5-86	Cruise Control	3-10
Cleaning Fabric/Carpet	5-82		

Customer Assistance Information	
Customer Assistance for Text Telephone (TTY)	
Users	7-5
Customer Satisfaction Procedure	7-2
GM Mobility Program for Persons with	
Disabilities	7-5
Reporting Safety Defects to Saturn	7-10
Reporting Safety Defects to the Canadian	
Government	7-10
Reporting Safety Defects to the United States	
Government	7-9
Roadside Assistance Program	7-6
Service Publications Ordering Information	7-10

D

Daytime Running Lamps	3-13
Daytime Running Lamps Indicator Light	3-39
Defensive Driving	4-2
Defogging and Defrosting	3-19, 3-23
Delayed Locking	2-10
Dinghy Towing	4-33
Disabling the Theft-Deterrent Feature	3-71
Doing Your Own Service Work	5-4
Dolly Towing	4-34
Dome Lamp	3-15
Door	
Delayed Locking	2-10
Locks	2-9

Door (cont.)	
Power Door Locks	2-10
Programmable Automatic Door Locks	2-11
Rear Door Security Locks	2-11
Driver	
Position, Safety Belt	1-16
Seat Height Adjuster	1-3
Six-Way Power Seat	1-4
Driving	
At Night	4-15
City	4-20
Defensive	4-2
Drunken	4-2
Freeway	4-21
Hill and Mountain Roads	4-24
In Rain and on Wet Roads	4-17
Winter	4-26
Driving on Grades	4-45
Driving on Snow or Ice	4-27
Driving Through Deep Standing Water	4-19
Driving Through Flowing Water	4-19
Driving with a Trailer	4-44
DVD	
Rear Seat Entertainment System	3-59
DVD Display Error Messages	3-67
DVD Distortion	3-68
DVD Radio	3-62
DVD Radio Error Messages	3-68

E

Electrical System	
Add-On Equipment	5-91
Fuses and Circuit Breakers	5-92
Power Windows and Other Power Options	5-92
Windshield Wiper Fuses	5-91
Emergency Trunk Release Handle (Sedan)	2-15
Emissions Inspection and Maintenance Programs	3-36
Engine	
Air Cleaner/Filter	5-20
Battery	5-39
Change Engine Oil Light	3-38
Check and Service Engine Soon Light	3-34
Coolant	5-23
Coolant Heater	2-22
Coolant Temperature Gage	3-33
Coolant Temperature Warning Light	3-32
Drive Belt Routing	6-14
Engine Compartment Overview	5-12
Exhaust	2-31
Oil	5-16
Overheating	5-26
Reduced Power Light	3-38
Starting	2-21
Engine Compartment Fuse Block	5-95
Engine Cooling When Trailer Towing	4-46
Engine Oil Additives	5-18
Entry Lighting	3-15

Event Data Recorders (EDR)	7-8
Express-Down Window	2-17
Extender, Safety Belt	1-35
Exterior Lamps	3-13

F

Filter	
Engine Air Cleaner	5-20
Finding a Station	3-42, 3-45, 3-50
Finish Care	5-86
Finish Damage	5-88
Fixed Mast Antenna	3-73
Flash-to-Pass	3-7
Flat Tire	5-69
Flat Tire, Changing	5-70
Floor Console Fuse Blocks	5-92
Fluid	
Automatic Transaxle	5-23
Power Steering	5-34
Windshield Washer	5-35
FM	3-71
Fog Lamps	3-14
Folding Rear Seat	1-8
Following Distance	4-44
Fuel	5-5
Additives	5-7
California Fuel	5-6

Fuel (cont.)

Filling a Portable Fuel Container	5-9
Filling Your Tank	5-8
Fuels in Foreign Countries	5-7
Gage	3-40
Gasoline Octane	5-5
Gasoline Specifications	5-6
Low Warning Light	3-40
Fuses	
Fuses and Circuit Breakers	5-92
Windshield Wiper	5-91

G

Gage	
Engine Coolant Temperature	3-33
Fuel	3-40
Speedometer	3-27
Tachometer	3-27
Gasoline	
Octane	5-5
Specifications	5-6
Glove Box	2-41
GM Mobility Program for Persons with Disabilities	7-5

H

Hazard Warning Flashers	3-4
Head Restraints	1-7
Headlamp High/Low-Beam Changer	3-7
Headlamps	3-7, 3-13
Bulb Replacement	5-46
Halogen Bulbs	5-46
Headlamps, Front Turn Signal, Sidemarker, and Parking Lamps	5-47
Headphones	3-59
Heated Seats	1-5
Height Adjuster, Driver Seat	1-3
Highway Hypnosis	4-23
Hill and Mountain Roads	4-24
Hitches	4-43
Hood	
Checking Things Under	5-10
Release	5-10
Horn	3-5
How to Add Coolant to the Coolant Surge Tank	5-31
How to Check	5-62
How to Check Power Steering Fluid	5-34
How to Inspect the Engine Air Cleaner/Filter	5-20
How to Use This Manual	ii
How to Wear Safety Belts Properly	1-16
Hydroplaning	4-19

I

If No Steam Is Coming From Your Engine	5-28
If Steam Is Coming From Your Engine	5-27
If the Light Is Flashing	3-35
If the Light Is On Steady	3-35
If You Are Caught in a Blizzard	4-28
If You Are Stuck in Sand, Mud, Ice or Snow	4-30
If You Do Decide to Pull a Trailer	4-41
Ignition Positions	2-20
Infants and Young Children, Restraints	1-38
Inflation - Tire Pressure	5-61
Installing the Cargo Shade	2-44
Instrument Panel	
Cluster	3-26
Overview	3-2
Instrument Panel Brightness	3-15
Interior Lamps	3-15

J

Jump Starting	5-40
---------------------	------

K

Keyless Entry System	2-4
Keys	2-3

L

Lamps	
Exterior	3-13
Fog Lamps	5-49
Interior	3-15
Lap Belt	1-32
Lap-Shoulder Belt	1-17, 1-26, 1-29
LATCH System	
Child Restraints	1-50
Securing a Child Restraint Designed for the LATCH System	1-52
Leaving Your Vehicle	2-12
Leaving Your Vehicle With the Engine Running	2-29
Liftgate Release (Wagon)	2-14
Liftgate/Trunk	2-13
Light	
Air Bag Readiness	3-28
Anti-Lock Brake System Warning	3-31
Battery Warning	3-29
Brake System Warning	3-30
Change Engine Oil	3-38
Daytime Running Lamps Indicator	3-39
Engine Coolant Temperature Warning	3-32
Low Coolant Warning	3-33
Low Fuel Warning	3-40
Low Washer Fluid Warning	3-39

Light (cont.)

Malfunction Indicator	3-34
Oil Pressure	3-37
Reduced Engine Power	3-38
Safety Belt Reminder	3-28
Security	3-38
Service Vehicle Soon	3-39
TCS Warning Light	3-32
Traction Control System (TCS) Warning	3-32
Trunk Ajar	3-39
Load Floor Storage Box	2-42
Loading Your Vehicle	4-34
Lockout Protection	2-12
Locks	
Delayed Locking	2-10
Door	2-9
Leaving Your Vehicle	2-12
Lockout Protection	2-12
Power Door	2-10
Programmable Automatic Door Locks	2-11
Rear Door Security Locks	2-11
Loss of Control	4-14
Low Coolant Warning Light	3-33
Low Fuel Warning Light	3-40
Low Washer Fluid Warning Light	3-39
Lumbar	
Manual Controls	1-4

M

Maintenance Schedule	
Additional Required Services	6-6
At Each Fuel Fill	6-9
At Least Once a Month	6-9
At Least Once a Year	6-10
Introduction	6-2
Maintenance Footnotes	6-7
Maintenance Record	6-15
Maintenance Requirements	6-2
Normal Maintenance Replacement Parts	6-13
Owner Checks and Services	6-9
Recommended Fluids and Lubricants	6-12
Scheduled Maintenance	6-4
Using Your	6-2
Your Vehicle and the Environment	6-2
Maintenance When Trailer Towing	4-46
Making Turns	4-44
Malfunction Indicator Light	3-34
Manual Lumbar Controls	1-4
Manual Operation	3-22
Manual Seats	1-3
Manual Windows	2-17
Map Lamps	3-15
Matching Transmitter(s) to Your Vehicle	2-7

Mirrors	
Automatic Dimming Rearview with Compass and Temperature Display	2-36
Automatic Dimming Rearview with OnStar [®] , Compass and Temperature Display	2-34
Manual Rearview Mirror	2-33
Manual Rearview Mirror with OnStar [®]	2-33
Outside Convex Mirror	2-39
Outside Heated Mirrors	2-39
Outside Power Mirrors	2-39
Outside Remote Control Mirror	2-38
MyGMLink.com	7-4

N

New Vehicle Break-In	2-19
Normal Maintenance Replacement Parts	6-13

O

Odometer	3-27
Off-Road Recovery	4-12
Oil	
Change Engine Oil Light	3-38
Engine	5-16
Pressure Light	3-37
Older Children, Restraints	1-35
Online Owner Center	7-4
OnStar [®] Personal Calling	2-41

OnStar [®] Services	2-40
OnStar [®] System	2-40
OnStar [®] Virtual Advisor	2-41
Operation	3-18
Other Warning Devices	3-5
Outlet Adjustment	3-24
Outside	
Convex Mirror	2-39
Heated Mirrors	2-39
Power Mirrors	2-39
Remote Control Mirror	2-38
Owner Checks and Services	6-9
Owner Publications	7-11
Owners, Canadian	ii

P

Park (P)	
Shifting Into	2-28
Shifting Out of	2-30
Parking	
Brake	2-27
Over Things That Burn	2-30
Parking on Hills	4-45
Passenger Compartment Air Filter	3-24
Passing	4-13, 4-44
Passlock [®]	2-18
Playing a Cassette Tape	3-52
Playing a CD	3-47

Playing the Radio	3-42, 3-45, 3-50
Playing the Single CD Player	3-54
Playing the Six-Disc CD Player	3-56
Power	1-4
Accessory Outlets	3-16
Door Locks	2-10
Electrical System	5-92
Reduced Engine Light	3-38
Steering Fluid	5-34
Windows	2-17
Power Steering	4-10
Programmable Automatic Door Locks	2-11

Q

Questions and Answers About Safety Belts	1-15
--	------

R

Radios	3-41
AM-FM Radio	3-42
Care of Your Cassette Tape Player	3-72
Care of Your CD and DVD Player	3-73
Care of Your CDs and DVDs	3-73
Radio with Cassette and CD	3-50
Radio with CD	3-45
Setting the Time	3-41
Theft-Deterrent	3-69
Understanding Reception	3-71

Rear Door Security Locks	2-11
Rear Safety Belt Comfort Guides	1-33
Rear Seat Entertainment System	3-59
Rear Seat Outside Passenger Positions (Wagon)	1-28
Rear Seat Passenger Positions (Sedan)	1-25
Rear Seat Passengers, Safety Belts	1-25
Rear Window Defogger	3-20, 3-23
Rear Window Wiper/Washer (Wagon)	3-9
Rearview Mirror, Automatic Dimming with Compass and Temperature Display	2-36
Rearview Mirror, Automatic Dimming with OnStar [®] , Compass and Temperature Display	2-34
Rearview Mirror with OnStar [®]	2-33
Rearview Mirrors	2-33
Reclining Seatbacks	1-5
Recommended Fluids and Lubricants	6-12
Recreational Vehicle Towing	4-32
Reduced Engine Power Light	3-38
Remote Control	3-64
Remote Keyless Entry System	2-4
Remote Keyless Entry System, Operation	2-5
Removing the Cargo Cover	2-44
Removing the Flat Tire and Installing the Spare Tire	5-74
Removing the Spare Tire and Tools (Sedan)	5-71
Removing the Spare Tire and Tools (Wagon)	5-72
Removing the Wheel	5-74
Replacement Bulbs	5-52
Replacing Brake System Parts	5-39

Reporting Safety Defects	
Canadian Government	7-10
Saturn	7-10
United States Government	7-9
Restraint System Check	
Checking Your Restraint Systems	1-72
Replacing Restraint System Parts After a Crash	1-73
Restraint Systems	
Checking	1-72
Replacing Parts	1-73
Resynchronization	2-8
Right Front Passenger Position, Safety Belts	1-25
Roadside	
Assistance Program	7-6
Rocking Your Vehicle To Get It Out	4-31
Roof Rack System	2-42
Routing, Engine Drive Belt	6-14
Running Your Engine While You Are Parked	2-32

S

Safety Belt	
Reminder Light	3-28
Safety Belts	
Care of	5-85
Driver Position	1-16
How to Wear Safety Belts Properly	1-16
Questions and Answers About Safety Belts	1-15

Safety Belts (cont.)	
Rear Safety Belt Comfort Guides for Children and Small Adults	1-33
Rear Seat Passengers	1-25
Right Front Passenger Position	1-25
Safety Belt Extender	1-35
Safety Belt Use During Pregnancy	1-24
Safety Belts Are for Everyone	1-11
Safety Chains	4-43
Safety Warnings and Symbols	iii
Scheduled Maintenance	6-4
Seats	
Driver Seat Height Adjuster	1-3
Head Restraints	1-7
Heated Seats	1-5
Manual	1-3
Manual Lumbar	1-4
Reclining Seatbacks	1-5
Six-Way Power Driver	1-4
Split Folding Rear Seat	1-8
Securing a Child Restraint	
Center Rear Seat Position	1-56
Designed for the LATCH System	1-52
Rear Outside Seat Position	1-54
Rear Seat Position	1-52
Right Front Seat Position	1-58
Security Light	3-38
Security While You Travel	7-6
Sedan	1-8, 1-48
Sensor	3-23

Service	5-3
Adding Equipment to the Outside of Your Vehicle	5-5
Doing Your Own Work	5-4
Engine Soon Light	3-34
Publications Ordering Information	7-10
Vehicle Soon Light	3-39
Service Bulletins	7-11
Service Engine Soon Light	3-34
Service Manuals	7-10
Setting Preset Stations	3-43, 3-46, 3-51
Setting the Time	3-41
Setting the Tone (Bass/Treble)	3-44, 3-47, 3-52
Sheet Metal Damage	5-87
Shift Lock Release	2-26
Shifting Into Park (P)	2-28
Shifting Out of Park (P)	2-30
Shoulder Belt Height Adjuster	1-19
Skidding	4-14
Some Other Rainy Weather Tips	4-20
Special Fabric Cleaning Problems	5-83
Specifications, Capacities	5-98
Speedometer	3-27
Split Folding Rear Seat	1-8
Starting Your Engine	2-21
Steering	4-10
Steering in Emergencies	4-11
Steering Tips	4-10
Steering Wheel, Tilt Wheel	3-5
Stereo RCA Jacks	3-60

Storage Areas	
Center Console Storage Area	2-41
Glove Box	2-41
Load Floor Storage Box	2-42
Roof Rack System	2-42
Storing a Flat or Spare Tire and Tools	5-79
Stuck in Sand, Mud, Ice or Snow	4-30
Sun Visors	2-18
Sunroof	2-45

T

Tachometer	3-27
Taillamps	
Turn Signal, Stoplamps and Back-up Lamps	5-50, 5-52
TCS Warning Light	3-32
Temperature and Compass Display	2-34
Temperature Display	2-37
Theft-Deterrent, Radio	3-69
Theft-Deterrent System	2-6
Theft-Deterrent Systems	2-18
Passlock [®]	2-18
Tilt Wheel	3-5
Tire Inflation Check	6-9
Tire Sidewall Labeling	5-54
Tire Size	5-58
Tire Terminology and Definitions	5-59
Tires	5-54

Vehicle Storage	5-40
Ventilation Adjustment	3-24
Video Screen	3-62
Visor Vanity Mirrors	2-18
Visors	2-18

W

Wagon	1-10, 1-48
Warning Lights, Gages and Indicators	3-25
Warnings	
Hazard Warning Flashers	3-4
Other Warning Devices	3-5
Safety and Symbols	iii
Vehicle Damage	iv
Washer Fluid, Low Warning Light	3-39
Washing Your Vehicle	5-85
Weight of the Trailer	4-41
Weight of the Trailer Tongue	4-42
What Kind of Engine Oil to Use	5-17
What to Do with Used Oil	5-20
What to Use	5-24, 5-34, 5-35
Wheels	
Alignment and Tire Balance	5-67
Replacement	5-67

When to Add Engine Oil	5-16
When to Change Engine Oil (GM Oil Life System)	5-19
When to Check	5-62
When to Check Power Steering Fluid	5-34
When to Inspect the Engine Air Cleaner/Filter	5-20
When You Are Ready to Leave After Parking on a Hill	4-46
Where to Put the Restraint	1-44
Why Safety Belts Work	1-12
Window Lock Out	2-18
Windows	2-16
Manual	2-17
Power	2-17
Windshield Washer	3-9
Fluid	5-35
Windshield Wiper	
Blade Replacement	5-53
Fuses	5-91
Windshield Wiper Lever	3-8
Winter Driving	4-26

Y

Your Vehicle and the Environment	6-2
--	-----

Free Manuals Download Website

<http://myh66.com>

<http://usermanuals.us>

<http://www.somanuals.com>

<http://www.4manuals.cc>

<http://www.manual-lib.com>

<http://www.404manual.com>

<http://www.luxmanual.com>

<http://aubethermostatmanual.com>

Golf course search by state

<http://golfingnear.com>

Email search by domain

<http://emailbydomain.com>

Auto manuals search

<http://auto.somanuals.com>

TV manuals search

<http://tv.somanuals.com>